



User's Guide

TD-2310D

TD-2320D

TD-2350D

TD-2320DF

TD-2350DF

TD-2320DSA

TD-2350DSA

Table of Contents

Before You Use Your Printer	1
Definitions of Notes	2
General Precautions	3
Trademarks and Licenses	5
Open Source Licensing Remarks	6
Important Note	7
Set Up Your Printer	8
Parts Description	9
LED Patterns and Indications	15
LCD Overview	19
Install the Label Support	26
Set the Date and Time	27
Restrict Access to Administration Menu Items	29
Set the Menu Security	30
Load Media Roll	31
Change the Media Roll Holder to Use a Custom Size Roll	32
Load a Media Roll	34
Load Fanfold Labels	37
Load a Large Diameter Roll	40
Load a Roll in a Printer with a Peeler Unit	43
Load a Roll in a Printer with a Cutter Unit	47
Load a Linerless Roll	50
Adjust the Sensor Position	53
Connect the Power Cord	56
Turn Power On/Off	57
Use the Printer's Power Supply Function	58
Update and Back Up Data using USB Flash Drive	59
Install Software	60
Install Printer Drivers and Software on a Computer	61
Available Applications	62
Connect the Printer to a Computer	63
Connect the Printer to a Computer Using a USB Cable	64
Connect the Printer to a Computer Using Wi-Fi	65
Connect the Printer to a Computer Using a Wired LAN	68
Connect the Printer to a Computer Using a Bluetooth Connection	69
Connect the Printer to a Computer Using RS-232C	70
Create and Print Labels Using Your Computer	71
Create and Print Labels Using P-touch Editor (Windows)	72
Main Window of P-touch Editor (Windows)	73
Tips for Better Printing Results When Using P-touch Editor	74
Create Labels and Print without Installing Software and Drivers	75
Print Using a USB Interface (Mass Storage Mode)	76
Notes on Printing Images without Using the Printer Driver	77
Print Labels Distributed to Multiple Printers to Reduce Printing Time (Windows)	78
Print Barcode Labels Using Crop Print (Windows, 300 DPI Printer Only)	80

Barcodes Compatible with Crop Print (Windows)	81
Barcode Document Compatible with Crop Print (Windows).....	82
Print Barcode Labels Using Crop Print (Windows, 300 DPI Printer Only)	83
Print Labels Using the Printer Driver (Windows).....	85
Print Labels Using Mobile Devices.....	86
Compatible Printing Apps.....	87
AirPrint Overview	88
Transfer Templates Created on a Computer to the Printer Using a Mobile Device	89
Standalone Printing	90
Create and Print Labels Using P-touch Editor (Windows)	91
Transfer a Template or Other Data from the Computer to the Printer (Windows).....	92
Transfer Multiple Items from the Computer to the Printer (Windows)	94
Transfer the Label Layout to the Printer.....	95
Call Up the Transferred Template on the Printer's LCD and Print.....	96
Print a Template That is Not Linked to a Database	97
Print a Template Linked to a Database	100
Use the Search Function to Find a Template or Database in Template List Mode.....	103
Edit Template Objects Before Printing.....	104
Change the Screen Display in Template Touch Mode	105
Print Labels Using Barcode Scanner or Other Devices (P-touch Template).....	106
P-touch Template Operations Overview.....	107
Create and Print Labels Using P-touch Editor (Windows)	108
Transfer a Template or Other Data from the Computer to the Printer (Windows).....	109
Transfer Multiple Items from the Computer to the Printer (Windows)	111
Specify the Barcode Scanner Settings (Windows).....	112
Connect the Printer to a Barcode Scanner Using Bluetooth	114
Connect the Printer to a Barcode Scanner Using USB Host Interface	115
Try the P-touch Template Function Using the Barcode List	116
Recall and Print the Template Transferred to the Printer (Recall Printing)	117
Insert Information into a Template Transferred to the Printer and Print It (Merge Printing)	121
Print the Template Linked to the Database (Database Lookup Printing).....	125
Print Transferred Templates in Serialised (Numerical) Order (Numbered (Serialised Number) Printing).....	129
Barcodes Used for Specifying Settings	131
Transfer Templates to the Printer Using Your Computer (Windows).....	134
Notes on Using Transfer Functions (Windows).....	135
Transfer a Template or Other Data from the Computer to the Printer (Windows).....	136
Transfer Multiple Items from the Computer to the Printer (Windows)	138
Back up Templates or Other Data Saved in the Printer to Your Computer (Windows)	139
Delete Printer Data from Your Computer (Windows)	140
Create Transfer Files and Transfer Package Files (Windows).....	141
Distribute Templates to be Transferred to Users.....	143
Network	146
Important Information for Security.....	147
Wireless Network Settings	148
Use the Wireless Network	149
Enable/Disable Wi-Fi.....	151

Network Features	152
Synchronise Time with the SNTP Server Using Web Based Management	153
Brother Management Tools	157
Security	158
Before Using Network Security Features	159
Configure Certificates for Device Security	160
Security Certificate Features Overview	161
How to Create and Install a Certificate	162
Create a Self-signed Certificate	163
Create a Certificate Signing Request (CSR) and Install a Certificate from a Certificate Authority (CA)	164
Import and Export the Certificate and Private Key	168
Import and Export a CA Certificate	171
Manage Multiple Certificates	174
Use SSL/TLS	175
Introduction to SSL/TLS	176
Manage Your Network Machine Securely Using SSL/TLS	179
Print Documents Securely Using SSL/TLS	184
Use SNMPv3	186
Manage Your Network Machine Securely Using SNMPv3	187
Use IEEE 802.1x Authentication for Your Network	188
What Is IEEE 802.1x Authentication?	189
Configure IEEE 802.1x Authentication Using Web Based Management (Web Browser)	190
IEEE 802.1x Authentication Methods	192
Update	193
Update P-touch Editor	194
Update the Firmware	195
Printer Settings	196
Change Printer Settings Using the Printer Setting Tool (Windows)	197
Printer Setting Tool: Communication Settings (Windows)	199
Printer Setting Tool (Windows): Device Settings	206
Printer Setting Tool (Windows): P-touch Template Settings	213
Printer Setting Tool (Windows): Paper Size Setup	215
Apply Setting Changes to Multiple Printers (Windows)	220
Change Printer Settings Using Web Based Management	221
Change the Login Password Using Web Based Management	222
Confirm Printer Settings	223
Details of Printer Settings Report	225
Print and Confirm Dump Data	235
Change Printer Settings Using the Printer	237
Settings Tables	238
Settings Tables	242
Routine Maintenance	247
Clean Your Printer	248
Replace the Coin Cell Battery	253
Replace the Parts	256
Check the Print Head	257





Troubleshooting	258
If You Are Having Difficulty with Your Machine	259
Error and Maintenance LEDs	260
Error and Maintenance Messages	267
Printing Problems	268
Version Information	275
Reset the Printer	276
Reset All Settings to the Factory Settings Using the Printer Buttons	277
Reset Settings Using the LCD Menu	278
Reset Data Using the Printer Setting Tool	279
Appendix	280
Specifications	281
Software Development Kit	284
LabelCLT	285
LabelCLT Overview	286
Transfer the Template Data File with LabelCLT	287
Transferring a PDZ Firmware File via USB: Example	288
Product Dimensions	294
Auto Media Configuration	303
Auto Media Configuration Overview	304
Use the Auto Media Configuration Function	305
Print History	306
Options	308
Recommended Tightening Torque When Installing Optional Parts	309
Change the Label Peeler Options (Windows)	310
Change the Cutting Options (Windows)	311
Brother Help and Customer Support	312

Before You Use Your Printer

- [Definitions of Notes](#)
- [General Precautions](#)
- [Trademarks and Licenses](#)
- [Open Source Licensing Remarks](#)
- [Important Note](#)

Definitions of Notes

We use the following symbols and conventions throughout this User's Guide:

 DANGER	DANGER indicates an imminently hazardous situation which, if not avoided, will result in death or serious injuries.
 WARNING	WARNING indicates a potentially hazardous situation which, if not avoided, could result in death or serious injuries.
 CAUTION	CAUTION indicates a potentially hazardous situation which, if not avoided, may result in minor or moderate injuries.
IMPORTANT	IMPORTANT indicates a potentially hazardous situation which, if not avoided, may result in damage to property or loss of product functionality.
NOTE	NOTE specifies the operating environment, conditions for installation, or special conditions of use.
	The tips icon indicates helpful hints and supplementary information.
Bold	Bold style identifies buttons on the machine's control panel or computer screen.
<i>Italics</i>	Italicised style emphasises an important point or refers you to a related topic.
Courier New	Courier New font identifies messages shown on the machine's LCD.



Related Information

- [Before You Use Your Printer](#)

General Precautions

Media Rolls

- Use Brother accessories and supplies.
- Some Media Rolls cannot be used with this printer due to their width or diameter. Be sure to check the types of compatible rolls before purchasing them.
- If the label is affixed to a wet, dirty, or oily surface, it may peel off easily. Before affixing the label, clean the surface to which the label is affixed.
- Store the Media Roll in a cool and dark place and use it soon after opening the package.
- DO NOT expose the Media Roll to direct sunlight, high temperature, high humidity, wind, or dust as it may cause labels to peel off or discolour.
- Scratching the printed surface of the label with your fingernails or metal objects, or touching the printed surface with wet hands, can cause the colour to change or fade.
- The displayed label length may differ from the actual length of the printed label.
- Depending on the location, material, and environmental conditions, labels may unpeel or become irremovable, or the colour may change or be transferred to other objects. Before applying labels, check the environmental conditions and the material.
- Small text may not be printed as clearly as it is displayed on your device's or computer's screen.
- Printed characters may differ from the ones displayed on your device's or computer's screen as it may support a resolution higher than that of the label printer.
- DO NOT use folded, wet or damp paper, otherwise a paper misfeed or a malfunction may result.
- DO NOT affix labels to people, animals, or plants. Never affix labels to public or private property without permission.
- As the last label of the Media Roll may not be printed correctly, each roll contains more labels than is indicated on the package.
- When a label is removed after being affixed to a surface, a portion of the label may remain.
- When a label is affixed, it may be difficult to remove the label.
- DO NOT leave a Media Roll in the printer for long periods of time. When printer is left unused for a long period of time, remove the roll before storing the printer.
 - Store Media Rolls in a cool, dark place, away from direct sunlight and any liquids. Keep it free from dust and dirt, as dust and dirt may increase friction during printing and shorten the life of the Print Head.
 - Store Media Rolls with the roll core vertically. Storing them horizontally, with the label surface down, may cause quality deterioration.
- For warnings and safety precautions, see the *Product Safety Guide*.

Machine

- DO NOT insert or remove the AC Adapter or battery pack during printing. This may cause product failure.
- Observe all applicable regulations when disposing of the printer and its accessories.
- DO NOT pull the media while printing or feeding; this could damage both the media and the printer.
- Any data stored in memory will be lost due to failure, or repair of the printer, or if the battery discharges completely.
- DO NOT remove the labels affixed to the printer. These labels provide operational information and indicate the printer's model number.
- DO NOT install the printer near any device that will cause electromagnetic interference. The machine may malfunction if left near such a device, such as a television, radio, or microwave oven.
- DO NOT transport the printer while cables are connected to the AC connector and USB port. The connector and ports could be damaged.
- The serial port is specifically designed only for the RJ25 to DB9M adapter optional accessories. Do not connect a telephone line or cash drawer.

-
- The printer's power supply function can cause it to get hot when use the function. If you unplug the USB cable and start printing when the printer is hot, the printer may temporarily enter Cooling Mode to cool it down.
 - DO NOT expose the printer to direct sunlight, high air temperature, or steam. If printing for a long time, the printer may not enter to Cooling Mode and become hot, which may cause malfunctions.
 - For warnings and safety precautions, see the *Product Safety Guide*.

Others

- Dispose of batteries at an appropriate collection point. Be sure to observe all applicable local regulations.
- If the printer can only be used for a short period of time, even though the rechargeable battery is fully charged, the rechargeable battery may have reached the end of its service life. Replace the rechargeable battery with a new one.



Related Information

- [Before You Use Your Printer](#)
-

Trademarks and Licenses

- Apple, App Store, Mac, Safari, AirPrint, the AirPrint logo, iPad, iPhone, iPod touch, macOS, and iPadOS are trademarks of Apple Inc., registered in the United States and other countries.
- Android, Google Chrome, Google Play, and the Google Play logo are trademarks of Google LLC.
- The Bluetooth® word mark and logos are registered trademarks owned by Bluetooth SIG, Inc. and any use of such marks by Brother Industries, Ltd. is under license. Other trademarks and trade names are those of their respective owners.
- QR Code is a registered trademark of DENSO WAVE INCORPORATED.
- Epson ESC/P is a registered trademark of Seiko Epson Corporation.
- Wi-Fi® is a registered trademark of Wi-Fi Alliance®.
- Wi-Fi Protected Setup™ is a trademark of Wi-Fi Alliance®.
- Adobe® and Reader® are either registered trademarks or trademarks of Adobe Systems Incorporated in the United States and/or other countries.
- QR Code Generating Program Copyright © 2008 DENSO WAVE INCORPORATED.
- BarStar Pro Encode Library (PDF417, Micro PDF417, DataMatrix, MaxiCode, AztecCode, GS1 Composite, GS1 Databar, Code93, MSI/Plessey, POSTNET, Intelligent Mail Barcode)
Copyright © 2007 AINIX Corporation. All rights reserved.
- Blue SDK
Copyright © 1995-2021 OpenSynergy GmbH.
All rights reserved. All unpublished rights reserved.
- Portions of this software are copyright © 2014 The FreeType Project (www.freetype.org). All rights reserved.
- USB Type-C® and USB-C® are registered trademarks of USB Implementers Forum.

Any trade names and product names of companies appearing on Brother products, related documents and any other materials are all trademarks or registered trademarks of those respective companies.



Related Information

- [Before You Use Your Printer](#)

Open Source Licensing Remarks

This product includes open source software.

To see the Open Source Licensing Remarks, go to your model's **Manuals** page on the Brother support website at support.brother.com/manuals.



Related Information

- [Before You Use Your Printer](#)
-

Important Note

- The contents of this document and the specifications of this product are subject to change without notice.
- Brother reserves the right to make changes without notice in the specifications and materials contained herein and shall not be responsible for any damages (including consequential) caused by the reliance on the materials presented, including, but not limited to, typographical and other errors relating to the publications.
- Screen images in this document may differ depending on your computer's operating system, your product model, and software version.
- Before using the printer, make sure you read all the documents included with it for information about safety and operation.
- The printer shown in the illustrations may be different from your printer.
- The available supplies may vary depending on your country or region.
- We recommend using the latest version of P-touch Editor compatible with your printer. For the latest version, go to your model's **Downloads** page at support.brother.com/downloads.
- To keep your printer's performance up to date, visit support.brother.com to check for the latest firmware updates. Otherwise, some of your printer's functions may not be available.
- Before giving your machine to anyone else, replacing it, or disposing of it, we strongly recommend resetting it to its factory settings to remove all personal information.



Related Information

- [Before You Use Your Printer](#)
-

Set Up Your Printer

- [Parts Description](#)
- [LED Patterns and Indications](#)
- [LCD Overview](#)
- [Install the Label Support](#)
- [Set the Date and Time](#)
- [Restrict Access to Administration Menu Items](#)
- [Set the Menu Security](#)
- [Load Media Roll](#)
- [Adjust the Sensor Position](#)
- [Connect the Power Cord](#)
- [Turn Power On/Off](#)
- [Use the Printer's Power Supply Function](#)
- [Update and Back Up Data using USB Flash Drive](#)



Parts Description

>> TD-2310D/TD-2320D/TD-2320DF
>> TD-2350D/TD-2350DF
>> TD-2320DSA/TD-2350DSA

TD-2310D/TD-2320D/TD-2320DF

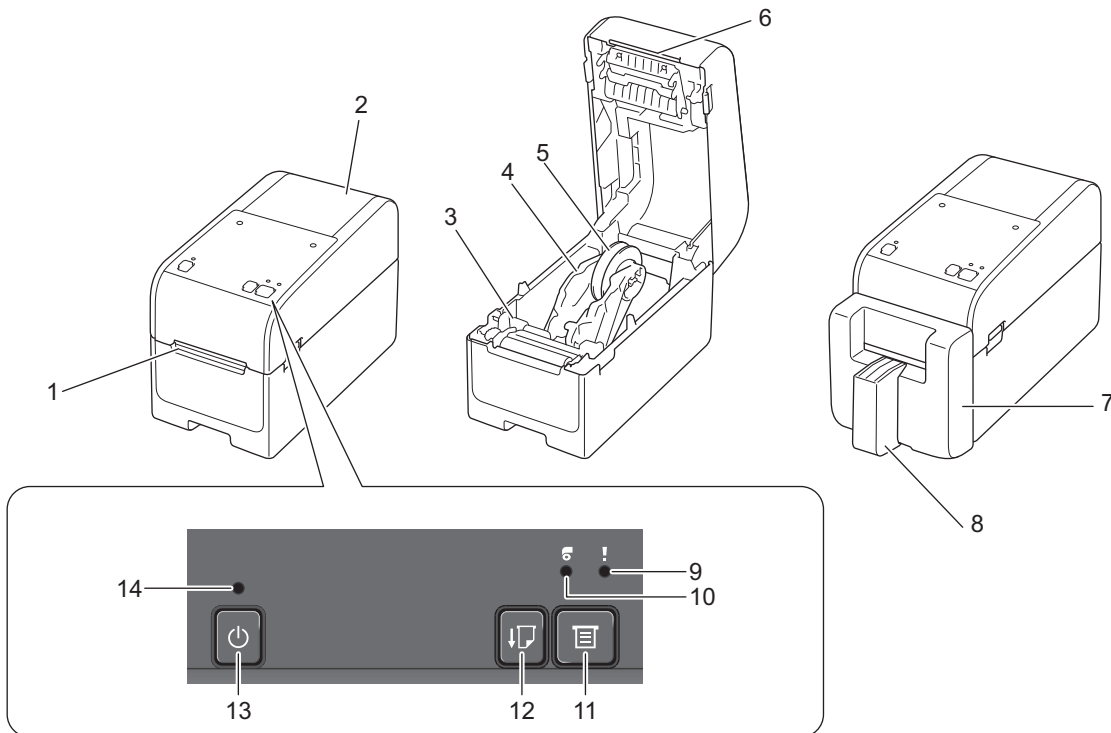
Front



1. Label Exit Slot
2. Roll Compartment Cover
3. Adjuster Dial
4. Roll Guide
5. Media Roll Holder
6. Tear Bar
7. Linerless Cutter Unit (TD-2320DF)
8. Label Support (TD-2320DF)
9. Status LED
10. Roll LED
11.  (Function) Button
12.  (Feed) Button
13.  (Power) Button
14. Power LED



To pause printing, press any button except  (Power). Press the button again to resume printing. Printing can be paused only after each full page has been printed and cannot be paused on the final page or between pages.

Rear

TD-2310D

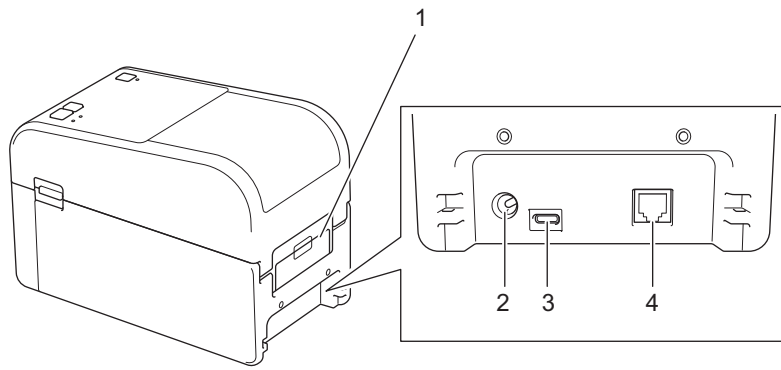

1. Rear Feed Port Cover
2. Power Port
3. USB Port (Type-C)
4. Serial Port (RJ25)

TD-2320D/TD-2320DF

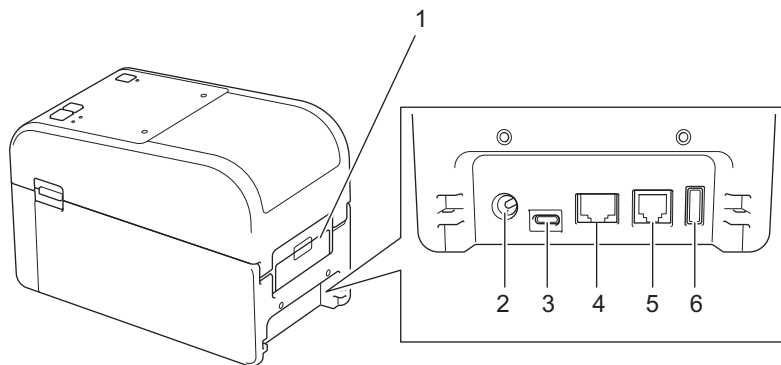

1. Rear Feed Port Cover
2. Power Port
3. USB Port (Type-C)
4. LAN Port
5. Serial Port (RJ25)
6. USB Host Port (Type-A)

Front

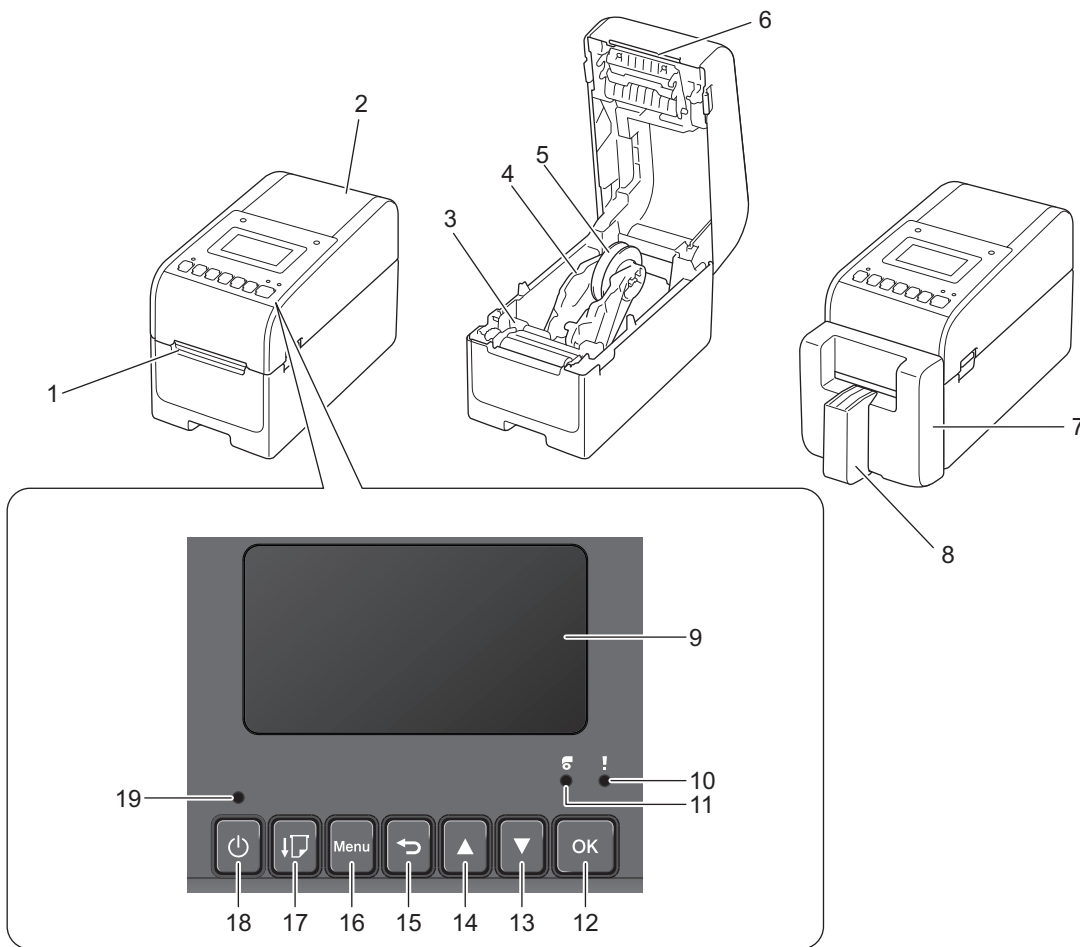

1. Label Exit Slot
2. Roll Compartment Cover
3. Adjuster Dial
4. Roll Guide
5. Media Roll Holder
6. Tear Bar
7. Linerless Cutter Unit (TD-2350DF)
8. Label Support (TD-2350DF)
9. LCD
10. Status LED
11. Roll LED
12. **OK** Button
13. **▼** (Down) Button
14. **▲** (Up) Button
15. **↶** (Back) Button
16. Menu Button
17. **↓** (Feed) Button
18. **⏻** (Power) Button
19. Power LED



To pause printing, press any button except  (Power), ▲ (Up), or ▼ (Down). Press the button again to resume printing. Printing can be paused only after each full page has been printed and cannot be paused on the final page or between pages.

Rear

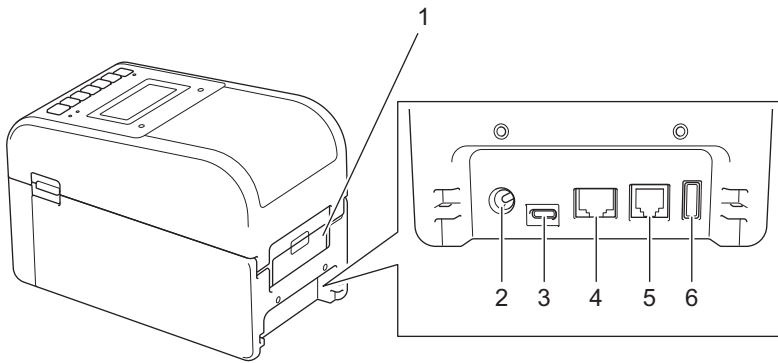

1. Rear Feed Port Cover
2. Power Port
3. USB Port (Type-C)
4. LAN Port
5. Serial Port (RJ25)
6. USB Host Port (Type-A)

Front

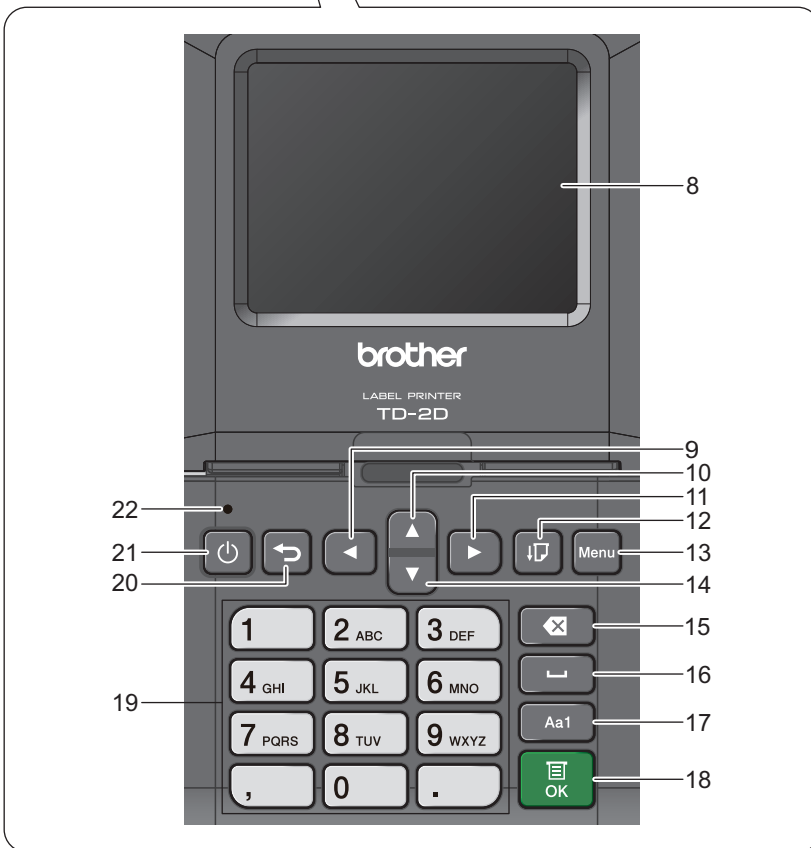
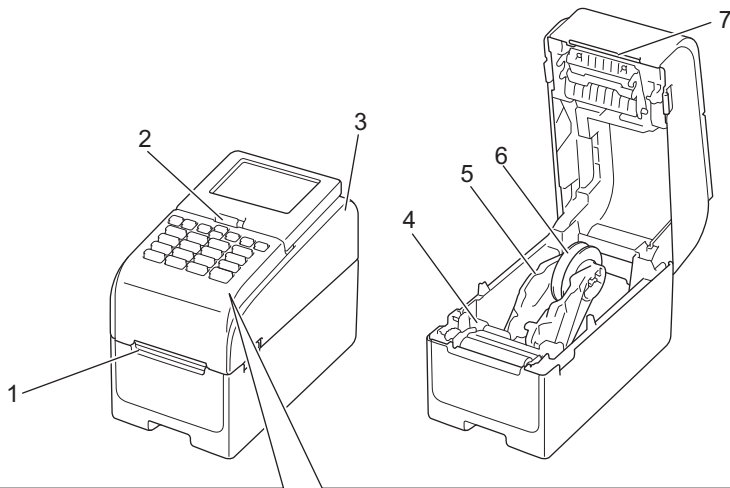

1. Label Exit Slot
2. Touchscreen Tilt Release Lever
When folding the Touch Panel, gently press the panel with one hand while pressing this lever toward the back of the machine.
3. Roll Compartment Cover
4. Adjuster Dial
5. Roll Guide
6. Media Roll Holder
7. Tear Bar
8. Touchscreen
9. ◀ (Left) Button
10. ▲ (Up) Button

11. ▶ (Right) Button
12. ↓ (Feed) Button
13. **Menu** Button
14. ▼ (Down) Button
15. ✕ (Delete) Button
16. □ (Space) Button
17. Character Input Mode Switching Button
18. **OK** Button
19. Numerical / Letter Buttons
20. ↶ (Back) Button
21. ⏻ (Power) Button
22. Power LED



To pause printing, press any button except ⏻ (Power), ▲ (Up), or ▼ (Down). Press the button again to resume printing. Printing can be paused only after each full page has been printed and cannot be paused on the final page or between pages.

Rear

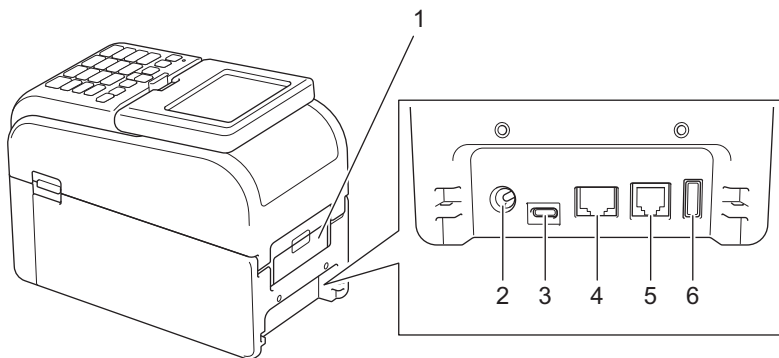

1. Rear Feed Port Cover
2. Power Port
3. USB Port (Type-C)
4. LAN Port
5. Serial Port (RJ25)
6. USB Host Port (Type-A)











Related Information

- [Set Up Your Printer](#)

LED Patterns and Indications

The LEDs light and flash to indicate the printer's status.

For information about errors, see *Related Topics: Error and Maintenance LEDs*.























 or  or 	LED is lit in the colour shown.
 or  or 	LED is flashing in the colour shown.
	LED can be off, lit, or flashing in any colour.
	LED is off.





































>> [TD-2310D/TD-2320D/TD-2320DF](#)

>> [TD-2350D/TD-2350DF](#)







>> [TD-2320DSA/TD-2350DSA](#)





























TD-2310D/TD-2320D/TD-2320DF

Power LED	Roll LED	Status LED	Condition
			Power is off.
			The printer is in Feeding mode.
			The printer is in Printing mode.
			The printer is in Cutting mode.
		 or  Depends on cover condition.	The printer is in Idle mode.
			The printer is in Mass Storage Mode.
			Detecting the paper size.
		 Repeat (0.5 seconds off, 0.5 seconds on)	The printer is in Print preparation mode.
			The printer is in Downloading mode.
			Cancelling the print job.
		 Once (0.5 seconds off, 0.5 seconds on)	Processing in Mass Storage Mode.
		 Repeat (1 second off, 1 second on)	Receiving data.
			The printer is in Dump mode.
			The printer is in Transferring mode.
		 Repeat (2 seconds off, 1 second on)	Printing is paused.
		 Repeat (0.5 seconds off, 0.5 seconds on)	The printer is in Cooling mode.

Power LED	Roll LED	Status LED	Condition
 Repeat (3 seconds off, 0.3 second on)			The printer is in Sleep mode.
 Repeat (0.5 seconds off, 0.5 seconds on)			The printer is in Data Rewriting mode.
 Three times (0.5 seconds off, 0.5 seconds on)		 Three times (0.5 seconds off, 0.5 seconds on)	Switching to Mass Storage Mode.
			The printer is in Initialising mode. The printer is in System Off mode.
 Three times (0.5 seconds off, 0.5 seconds on)		 Three times (0.5 seconds off, 0.5 seconds on)	Numbering initialization is complete.
 Once (0.5 seconds off, 0.5 seconds on)		 Once (0.5 seconds off, 0.5 seconds on)	Initialization is complete.
			The printer is in Boot mode. The printer is in Reset mode.
			The printer is in Reset mode.
			The printer is in Reset mode.
 Flashes three times (0.3 seconds off, 0.3 seconds on) , and then on	 Flashes three times (0.3 seconds off, 0.3 seconds on) , and then on	 Flashes three times (0.3 seconds off, 0.3 seconds on) , and then on	The printer is in Data Rewriting mode.
 1 second off and then Repeat (0.5 seconds on, 1 second off)	 1 second off and then Repeat (0.5 seconds on, 1 second off)	 1 second off and then Repeat (0.5 seconds on, 1 second off)	The printer is in Reset mode.
			The Roll Compartment Cover is open.









TD-2350D/TD-2350DF

Power LED	Roll LED	Status LED	Condition
			Power is off.
			The printer is in Feeding mode. The printer is in Printing mode. The printer is in Cutting mode.

Power LED	Roll LED	Status LED	Condition
		 or  Depends on cover condition.	The printer is in Idle mode. The printer is in Mass Storage Mode. The printer is in Template selection mode.
			Detecting the paper size.
		 Repeat (0.5 seconds off, 0.5 seconds on)	The printer is in Print preparation mode. The printer is in Downloading mode. Cancelling the print job.
	 Once (0.5 seconds off, 0.5 seconds on)	Processing in Mass Storage Mode.	
	 Repeat (1 second off, 1 second on)	Receiving data. The printer is in Dump mode. The printer is in Transferring mode.	
		 Repeat (2 seconds off, 1 second on)	Printing is paused.
	 Repeat (0.5 seconds off, 0.5 seconds on)	The printer is in Cooling mode.	
	 Repeat (3 seconds off, 0.3 second on)		
 Repeat (0.5 seconds off, 0.5 seconds on)			The printer is in Data Rewriting mode.
			The printer is in Initialising mode. The printer is in System Off mode.
			 Three times (0.5 seconds off, 0.5 seconds on)
 Once (0.5 seconds off, 0.5 seconds on)		 Once (0.5 seconds off, 0.5 seconds on)	Notifying completion of initialization.
			The printer is in Boot mode.
			The Roll Compartment Cover is open.

TD-2320DSA/TD-2350DSA

Power LED	Condition
	Power is off.

Power LED	Condition
	The printer is in Feeding mode.
	The printer is in Printing mode.
	The printer is in Cutting mode.
	The printer is in Idle mode.
	The printer is in Mass Storage Mode.
	The printer is in Template selection mode.
	The printer is in Template touch mode.
	The printer is in Label ID input mode.
	Detecting the paper size.
	The printer is in Print preparation mode.
	The printer is in Downloading mode.
	Cancelling the print job.
	Processing in Mass Storage Mode.
	Receiving data.
	The printer is in Dump mode.
	The printer is in Transferring mode.
Printing is paused.	
The printer is in Cooling mode.	
 Repeat (3 seconds off, 0.3 second on)	The printer is in Sleep mode.
 Repeat (0.5 seconds off, 0.5 seconds on)	The printer is in Data Rewriting mode.
	The printer is in Initialising mode.
	The printer is in System Off mode.
 Three times (0.5 seconds off, 0.5 seconds on)	Notifying completion of numbering initialization.
 Once (0.5 seconds off, 0.5 seconds on)	Notifying completion of initialization.
	The printer is in Boot mode.
	The Roll Compartment Cover is open.

Related Information

- [Set Up Your Printer](#)

Related Topics:

- [Error and Maintenance LEDs](#)

LCD Overview

Related Models: TD-2350D/TD-2350DF/TD-2320DSA/TD-2350DSA



A protective clear plastic film is placed over the display during manufacturing and shipping. This film should be removed prior to use.

>> [TD-2350D/TD-2350DF](#)

>> [TD-2320DSA/TD-2350DSA](#)

TD-2350D/TD-2350DF

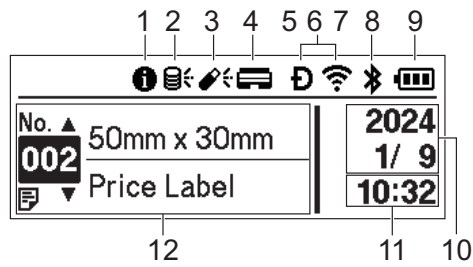

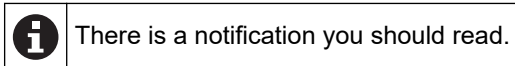

1. Information icon



2. Update icon (Network)

Indicates that updated templates, databases, and other data are available.

	There is new data.
 (flashing)	There is incomplete update data.
 (flashing)	Cannot connect to the server.

Remote Data Update (FTP)

Allows you to connect your printer to the FTP server to perform template and database updates, and to execute commands to distribute update data among multiple printers connected to a network.

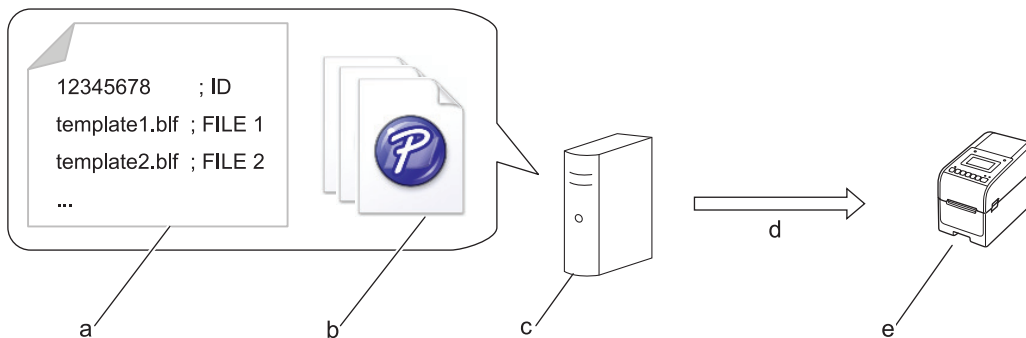



- Settings file (updateinfo.ini)
- Files you want to update, such as template and database files (BLF/BIN files)
To convert a label file (LBX) or database file (Excel, CSV) to a BLF file, use P-touch Editor.
- FTP Server
- Retrieval of update data from the FTP server
- Printer (FTP Client)

For more information on how to update data, visit the Brother support website at support.brother.com.

3. Update icon (USB Flash Drive)

Indicates that updated templates, databases, and other data are available.

	There is new data.
 (flashing)	There is remaining update data.

Local Data Update (USB Flash Drive)

Allows you to perform template and database updates and execute commands after reading the files from a USB Flash Drive connected to the printer.

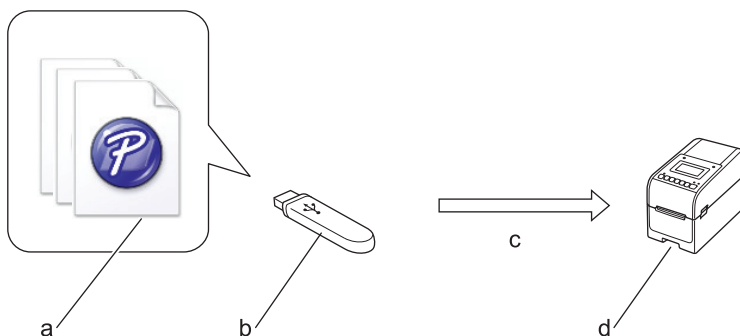



- Files you want to update data, such as template and database files (BLF/BIN files)



- b. USB Flash Drive
- c. Retrieval of update data
- d. Printer

For more information on how to update data, see *Related Topics: Update and Back Up Data using USB Flash Drive*.



4. Print Head Status icon

	Normal state.
	The Print Head is disconnected or there is a problem with the Print Head.

5. Wireless Direct icon

	Wireless Direct mode is on. Your printer is not connected to the mobile device.
	Wireless Direct mode is on. Your printer is connected to the mobile device.



6. WLAN icon

	Your printer is connected to the network.
	Your printer is searching for a wireless network.





7. Wired LAN icon

	Your printer is connected to the network.
---	---

8. Bluetooth® icon

	Bluetooth mode is on. Your printer is not connected to the mobile device.
	Bluetooth mode is connected. Your printer is connected to the mobile device.
	The Auto Reconnect function is on, but your printer is not connected to the mobile device.

9. Battery icon

	The battery is fully or almost fully charged.
	The battery is charging and is almost fully charged.
	The battery level is low.
	The battery level is low but is being charged.

10. Date display

11. Time display

12. Template

NOTE

The printer may malfunction if you try to configure it while it is processing or printing a print job.

TD-2320DSA/TD-2350DSA

Three different screen types are available to set as your Home Screen. Select the style you prefer by going to [Settings] > [Home Screen]:

- **Status Screen**

Displays the printer's status.

- **Template List Screen**

Displays all templates, in list format, that have been transferred to the printer. This screen features a Search function so you can find specific templates and databases.

- **Template Touch Screen**

Displays all templates, in tile format, that have been transferred to the printer.

Select the template or database you want to use by tapping it.

Status Screen

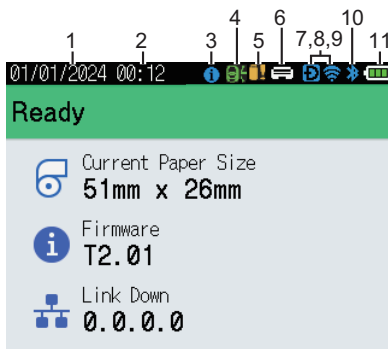

Template List Screen



Template Touch Screen



1. Date display
2. Time display
3. Information icon

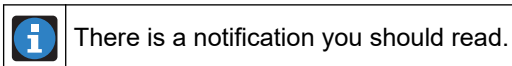



You can change the Template Touch Screen colour.

For more information, go to your model's **Downloads** page on the Brother support website at support.brother.com. Scroll to the **Utilities** section, and click **Template samples and the manual** to check manual.

4. Update icon (Network)

Indicates that updated templates, databases, and other data are available.

	There is new data.
 (flashing)	There is incomplete update data.
 (flashing)	Cannot connect to the server.

Remote Data Update (FTP)

Allows you to connect your printer to the FTP server to perform template and database updates, and to execute commands to distribute update data among multiple printers connected to a network.

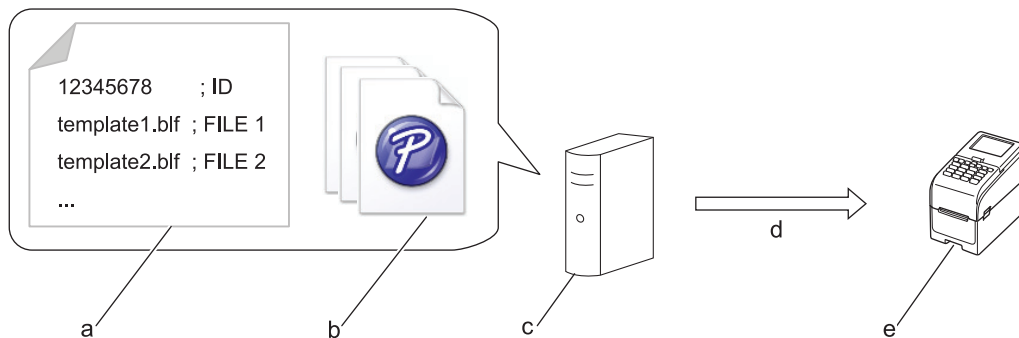



- a. Settings file (updateinfo.ini)
- b. Files you want to update, such as template and database files (BLF/BIN files)
To convert a label file (LBX) or database file (Excel, CSV) to a BLF file, use P-touch Editor.
- c. FTP Server
- d. Retrieval of update data from the FTP server
- e. Printer (FTP Client)

For more information on how to update data, visit the Brother support website at support.brother.com.

5. Update icon (USB Flash Drive)

Indicates that updated templates, databases, and other data are available.

	There is new data.
 (flashing)	There is remaining update data.

Local Data Update (USB Flash Drive)

Allows you to perform template and database updates and execute commands after reading the files from a USB Flash Drive connected to the printer.

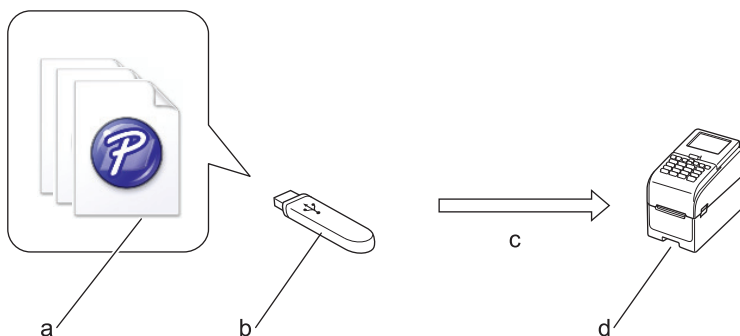



- a. Files you want to update data, such as template and database files (BLF/BIN files)



- b. USB Flash Drive
- c. Retrieval of update data
- d. Printer

For more information on how to update data, see *Related Topics: Update and Back Up Data using USB Flash Drive*.





6. Print Head Status icon

	Normal state.
	The Print Head is disconnected or there is a problem with the Print Head.

7. Wireless Direct icon

	Wireless Direct mode is on. Your printer is not connected to the mobile device.
	Wireless Direct mode is on. Your printer is connected to the mobile device.



8. WLAN icon

  	Your printer is connected to the network.
	Your printer is searching for a wireless network.





9. Wired LAN icon

	Your printer is connected to the network.
---	---

10. Bluetooth icon

	Bluetooth mode is on. Your printer is not connected to the mobile device.
	Bluetooth mode is connected. Your printer is connected to the mobile device.
 (flashing)	The Auto Reconnect function is on, but your printer is not connected to the mobile device.

11. Battery icon

	The battery is fully or almost fully charged.
	The battery is charging and is almost fully charged.
	The battery level is low.
	The battery level is low but is being charged.

NOTE

The printer may malfunction if you try to configure it while it is processing or printing a print job.



Related Information

- [Set Up Your Printer](#)

Related Topics:

- [Update and Back Up Data using USB Flash Drive](#)
-

Install the Label Support

Related Models: TD-2320DF/TD-2350DF

These linerless models require the Label Support, which keeps the label's adhesive from sticking to unwanted surfaces like the desk or the floor.

1. Insert the Label Support into the center of the Label Exit Slot.

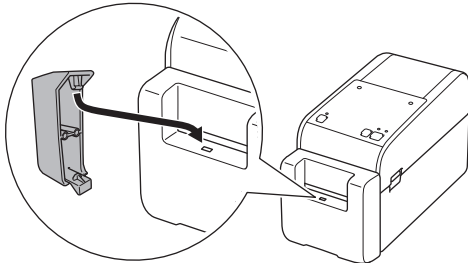

2. Gently press the Label Support until it locks into position.

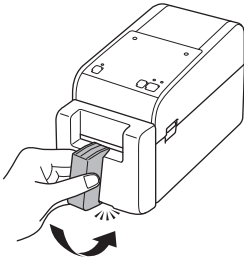

Related Information

- [Set Up Your Printer](#)

Set the Date and Time

Related Models: TD-2350D/TD-2350DF/TD-2320DSA/TD-2350DSA

>> [TD-2350D/TD-2350DF](#)

>> [TD-2320DSA/TD-2350DSA](#)

TD-2350D/TD-2350DF

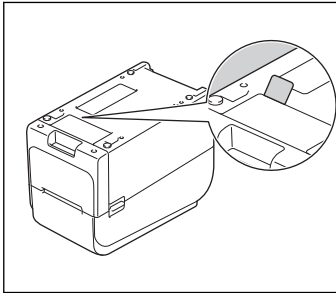

Make sure you remove the protective sheet before setting the date and time. If you don't, the clock will reset every time you turn the printer off.

1. Press **Menu**.
2. Press **▲** or **▼** to select the following:
 - a. Select [Administration]. Press **OK**.
 - b. Select [Time & date]. Press **OK**.
 - c. Select [Set Clock]. Press **OK**.
3. Press **▲** or **▼** to set the year, and then press **OK**. Repeat this step for setting the month and day.
4. Press **▲** or **▼** to select [AM], [PM], or [24], and then press **OK**.
5. Press **▲** or **▼** to set the hour, and then press **OK**. Repeat this step for setting the minute.



To change the date and time format, select [Administration] > [Date Format] or [Administration] > [Time Format], and then specify the settings.

TD-2320DSA/TD-2350DSA

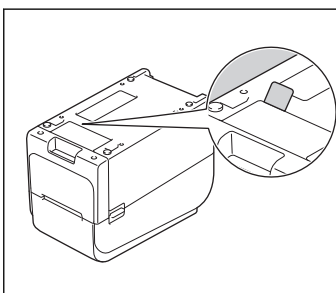

Make sure you remove the protective sheet before setting the date and time. If you don't, the clock will reset every time you turn the printer off.

1. Press **Menu**.
2. Press **▲** or **▼** to select the following:
 - a. Select [Administration]. Press **OK**.
 - b. Select [Time & date]. Press **OK**.
 - c. Select [Clock Manual Setup]. Press **OK**.
3. Select [Date], and then press **OK**.
Enter the year using numerical buttons and press **OK**. Repeat this step for setting the month and day.
4. Select [AM], [PM], or [24], and then press **OK**.
5. Select [Time], and then press **OK**.
6. Enter the hour and minute using numerical buttons, and then press **OK**.



To change the date and time format, select [Administration] > [Date Format] or [Administration] > [Time Format], and then specify the settings.

7. Press .



Related Information

- [Set Up Your Printer](#)
-

Restrict Access to Administration Menu Items

Related Models: TD-2350D/TD-2350DF/TD-2320DSA/TD-2350DSA

Access restrictions can be set for every item in the Administration Menu.

1. Press **Menu**.
2. Press **▲** or **▼** to select the following:
 - a. Select [Administration]. Press **OK**.
 - b. Select [Menu Lock]. Press **OK**.
3. Press **▲**, **▼**, or **OK** to select the menu items you want.
4. Press **▲** or **▼** to select [Finish], and then press **OK** to complete the settings.



Related Information

- [Set Up Your Printer](#)

Related Topics:

- [Printer Setting Tool \(Windows\): Device Settings](#)

Set the Menu Security

Related Models: TD-2350D/TD-2350DF/TD-2320DSA/TD-2350DSA

When setting the menu security, access to the Administration menu can be restricted by setting a passcode.

>> [TD-2350D/TD-2350DF](#)

>> [TD-2320DSA/TD-2350DSA](#)

TD-2350D/TD-2350DF

1. Press **Menu**.
 2. Press **▲** or **▼** to select the following:
 - a. Select [Administration]. Press **OK**.
 - b. Select [Menu Security]. Press **OK**.
 3. Press **▲** or **▼** to select [On]. Press **OK**.
 4. Press **▲** or **▼** to specify the first number of the four-digit security passcode, and then press **OK**.
Repeat this step for the remaining three numbers.
- If a passcode has already been set, the passcode input screen appears whenever the [Administration] menu is selected. Press **▲** or **▼** and **OK** after each number to enter the specified four-digit passcode, and then press **OK**.
 - To cancel Menu Security and turn off the passcode input screen, select the [Administration] menu and enter the passcode. Then, select [Menu Security] > [Off].
 - If you do not remember the passcode, use the Device Settings in the Printer Setting Tool to return all settings to their factory values and set the passcode again.

TD-2320DSA/TD-2350DSA

1. Press **Menu**.
 2. Press **▲** or **▼** to select the following:
 - a. Select [Administration]. Press **OK**.
 - b. Select [Menu Security]. Press **OK**.
 3. Press **▲** or **▼** to select [On]. Press **OK**.
 4. Press the numerical buttons to specify the four-digit security passcode, and then press **OK**.
- If a passcode has already been set, the passcode input screen appears whenever the [Administration] menu is selected. Enter the four-digit passcode using numerical buttons, and then press **OK**.
 - To cancel Menu Security and turn off the passcode input screen, select the [Administration] menu and enter the passcode. Then, select [Menu Security] > [Off].
 - If you do not remember the passcode, use the Device Settings in the Printer Setting Tool to return all settings to their factory values and set the passcode again.



Related Information

- [Set Up Your Printer](#)

Related Topics:

- [Printer Setting Tool \(Windows\): Device Settings](#)

Load Media Roll

- [Change the Media Roll Holder to Use a Custom Size Roll](#)
- [Load a Media Roll](#)
- [Load Fanfold Labels](#)
- [Load a Large Diameter Roll](#)
- [Load a Roll in a Printer with a Peeler Unit](#)
- [Load a Roll in a Printer with a Cutter Unit](#)
- [Load a Linerless Roll](#)

Change the Media Roll Holder to Use a Custom Size Roll

If the convex part of the Media Roll Holder fits within the inner diameter of the roll paper core, the roll is usable. Using a Media Roll Holder close to the inner diameter of the roll paper core provides more stable media feeding.

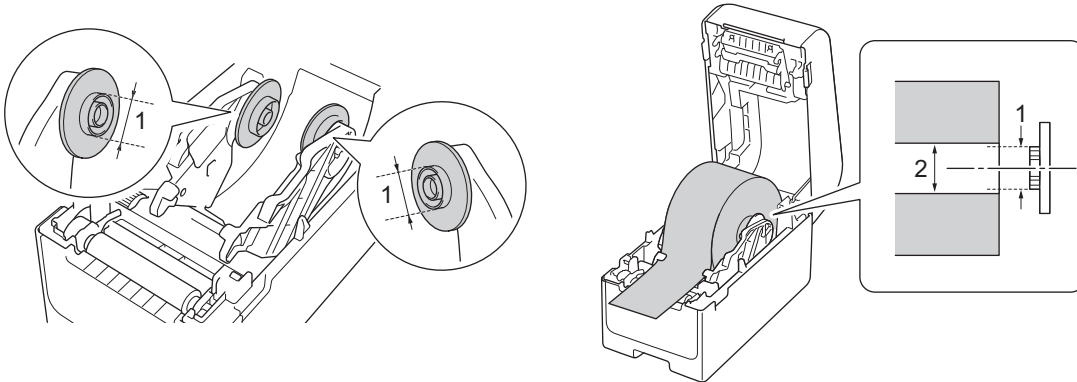

1. Media Roll Holder convex outer diameter
2. Media Roll paper core inner diameter

Media Roll Holders with a core diameter of 25.4 mm/34.9 mm has been installed at the factory.



- A Media Roll Holder for core diameters of 12.7 mm/19 mm are included. Contact Brother customer service for Media Roll Holders compatible with other core diameters.
- The roll core sizes are marked on the Media Roll Holders.

1. Press and hold  to turn the printer off.
2. Pull up the release levers on both sides of the printer to unlock the Roll Compartment Cover.

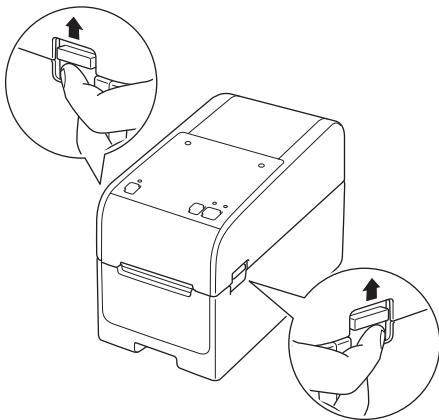

3. Hold the front of the printer, and firmly lift the Roll Compartment Cover to open it.

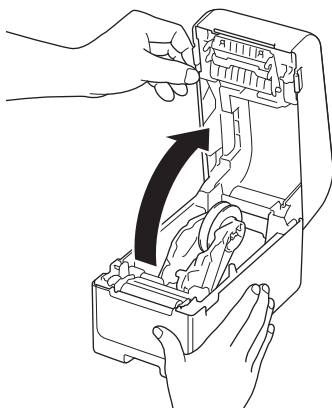

⚠ CAUTION

Do not touch the Tear Bar with your hands. Doing so may result in injury.

4. Pull up the lever on the Roll Guide to remove the Media Roll Holder. Do this for the both Roll Guides.

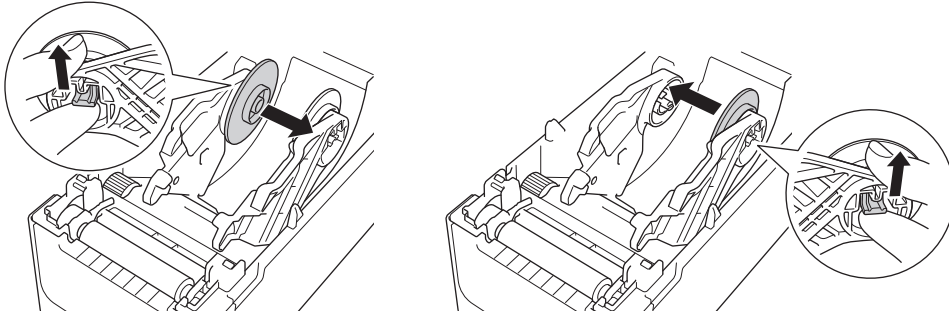

5. Align the center pin of the Roll Guide with the hole in the Media Roll Holder, then push the Media Roll Holder onto the Roll Guide for installation. Do this for the both Roll Guides.

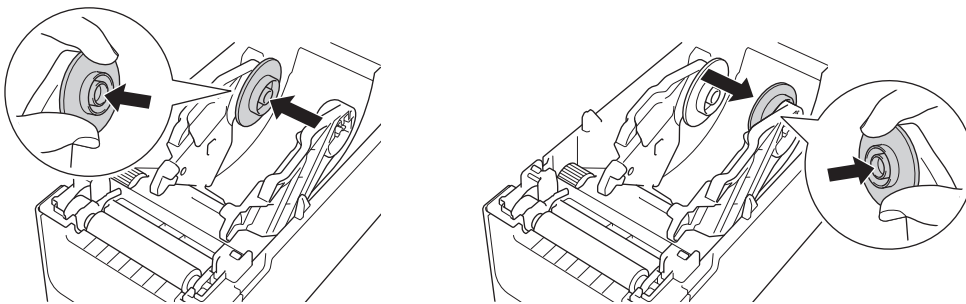

6. Close the Roll Compartment Cover until it locks into place.

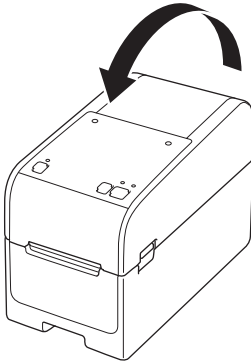

⚠ CAUTION

Be careful when closing the Roll Compartment Cover. There is a risk of injury if your finger gets pinched between the upper and lower parts of the cover.

✓ Related Information

- [Load Media Roll](#)

Load a Media Roll

1. Press and hold  to turn the printer off.
2. Pull up the release levers on both sides of the printer to unlock the Roll Compartment Cover.

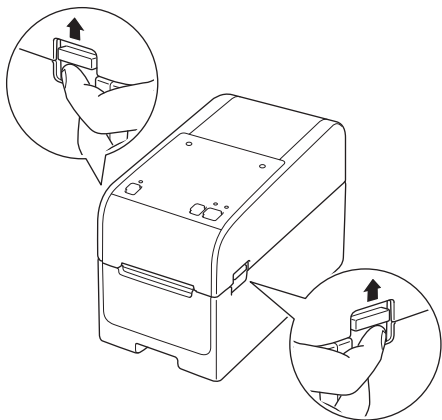

3. Hold the front of the printer, and firmly lift the Roll Compartment Cover to open it.

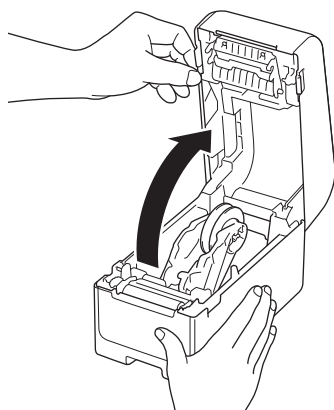

CAUTION

Do not touch the Tear Bar with your hands. Doing so may result in injury.

4. Slide both Roll Guides outwards.

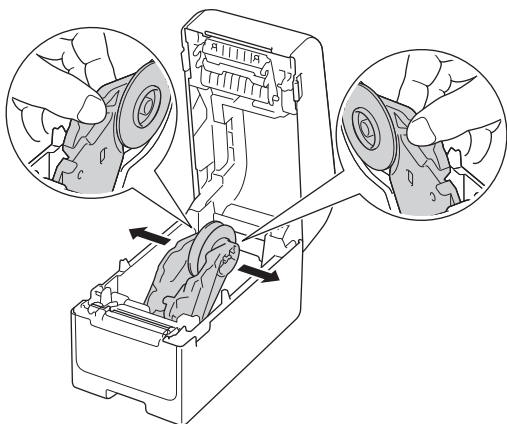

5. Insert the roll so that the label's printing surface is facing up, as shown in the illustration.

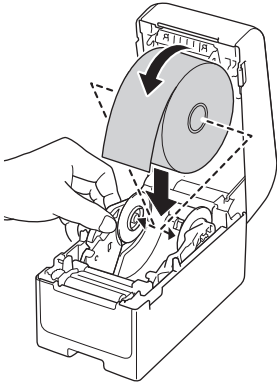

Rotate the Adjuster Dial to lock the Roll Guides in the appropriate position.

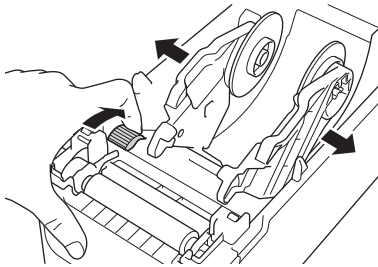
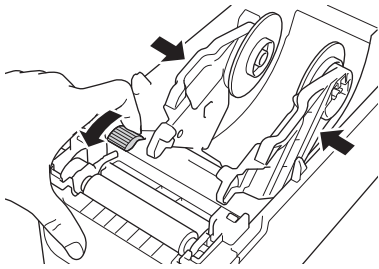

6. Feed the end of the backing paper under the Media Guide Tips (1).
Make sure the label extends slightly out of the Label Exit Slot.

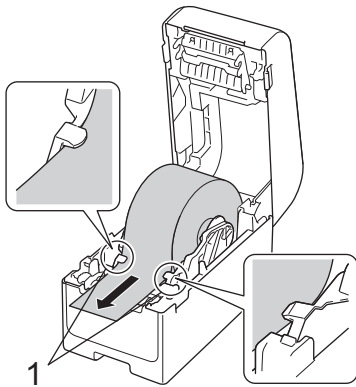

NOTE

When using media with a width of 22.9 mm or less, make sure the media exiting from the Label Exit Slot is not tilted to avoid labels being fed diagonally.

Top View

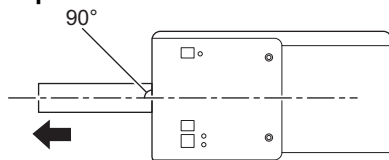

7. Close the Roll Compartment Cover until it locks into place.

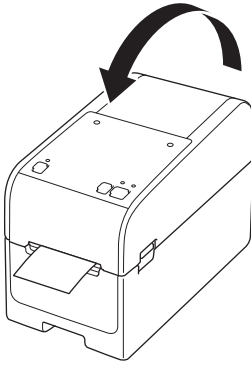

CAUTION

Be careful when closing the Roll Compartment Cover. There is a risk of injury if your finger gets pinched between the upper and lower parts of the cover.

IMPORTANT

- Do not leave any printed labels in the printer. Doing so will cause label jams.
 - When the printer is not in use, remove any rolls from it and close the Roll Compartment Cover.
-

Related Information

- [Load Media Roll](#)
-

Load Fanfold Labels

1. Press and hold  to turn the printer off.
2. Open the Rear Feed Port Cover.

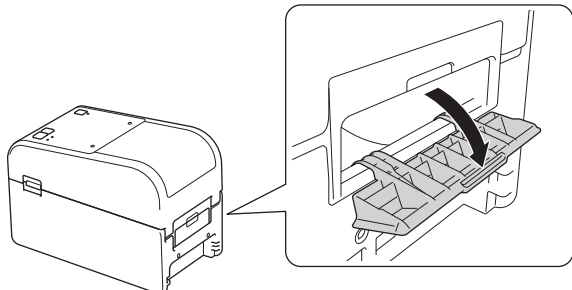

3. Pull up the release levers on both sides of the printer to unlock the Roll Compartment Cover.

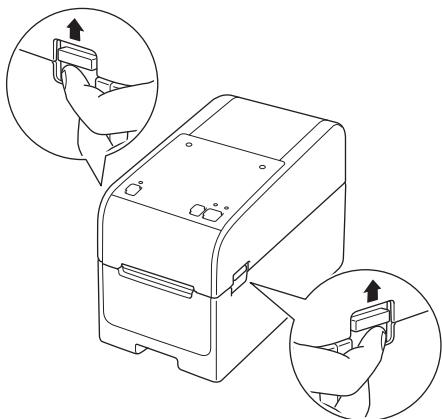

4. Hold the front of the printer, and firmly lift the Roll Compartment Cover to open it.

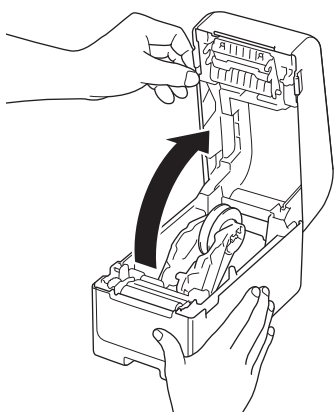

CAUTION

Do not touch the Tear Bar with your hands. Doing so may result in injury.

5. Rotate the Adjuster Dial to lock the Roll Guides in the appropriate position.

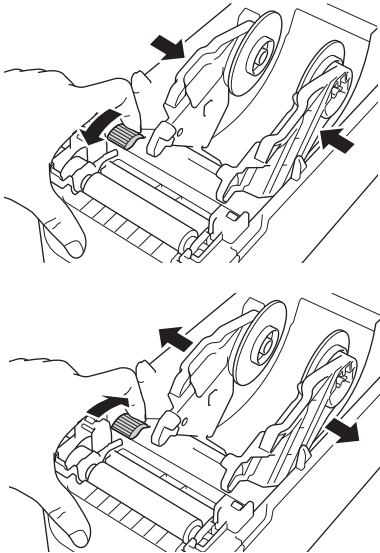

6. Place the fanfold labels at least one label's length away from the printer and feed the first fanfold label through the Rear Feed Port with the printing surface facing up.

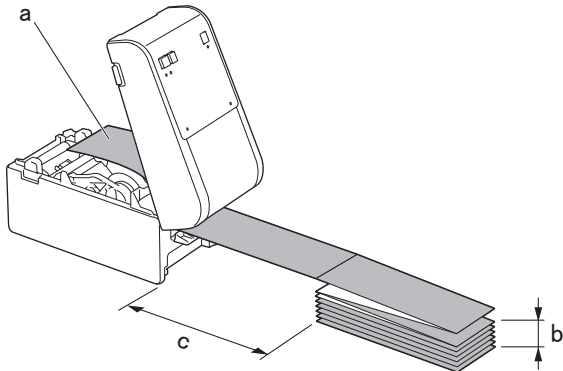

- a. Printing surface
- b. Maximum height of fanfold label: 100 mm
- c. Minimum distance between the printer and the fanfold labels: 150 mm



Make sure the labels pass under the Media Roll Holder, as shown in the illustration.

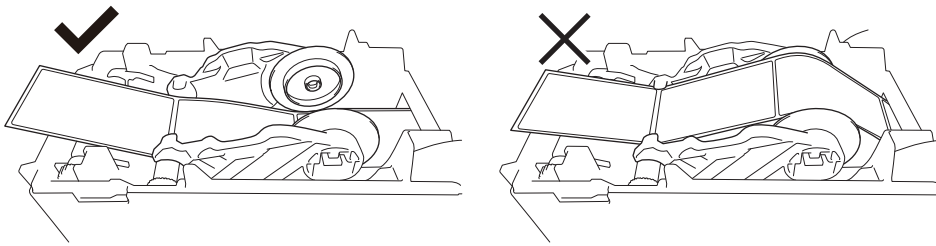

NOTE

- Feed the fanfold label with the printing surface facing up.
- If there is not enough room behind the printer to place the fanfold labels at the correct distance, you can rest the stack below the back of the printer, but not above.

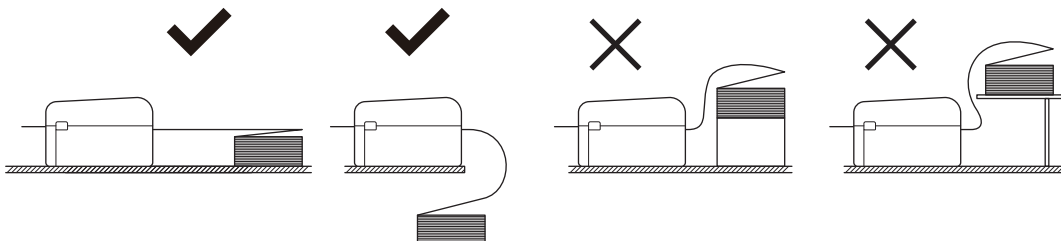

- Make sure the fanfold label stack is aligned precisely with the printer's Rear Feed Port.

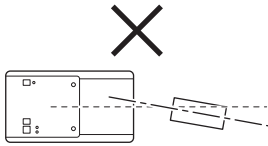

- Do not allow fanfold labels to touch any cables attached to the printer.
- If you encounter any label feeding problems, increase the distance between the printer and the fanfold label stack.

7. Feed the end of the backing paper under the Media Guide Tips (1).

Make sure the label extends slightly out of the Label Exit Slot.

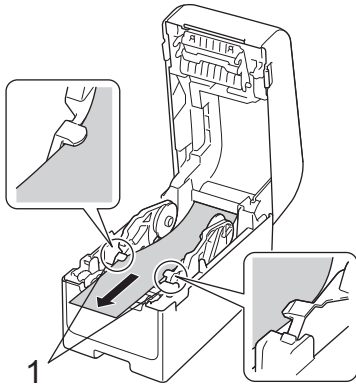

8. Close the Roll Compartment Cover until it locks into place.

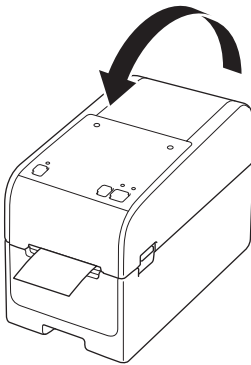

⚠ CAUTION

Be careful when closing the Roll Compartment Cover. There is a risk of injury if your finger gets pinched between the upper and lower parts of the cover.

IMPORTANT

- Do not leave any printed labels in the printer. Doing so will cause label jams.
- When the printer is not in use, remove any media from it and close the Roll Compartment Cover.

✓ Related Information

- [Load Media Roll](#)

Load a Large Diameter Roll

1. Press and hold  to turn the printer off.
2. Open the Rear Feed Port Cover.

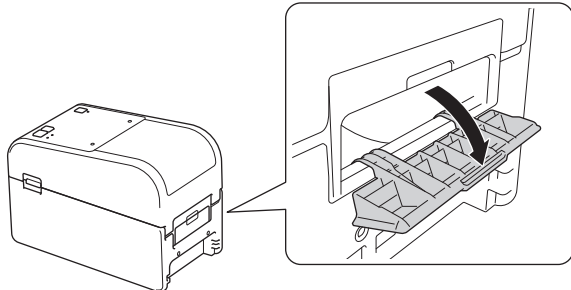

3. Pull up the release levers on both sides of the printer to unlock the Roll Compartment Cover.

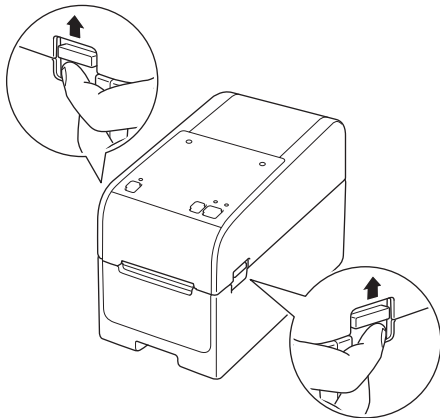

4. Hold the front of the printer, and firmly lift the Roll Compartment Cover to open it.

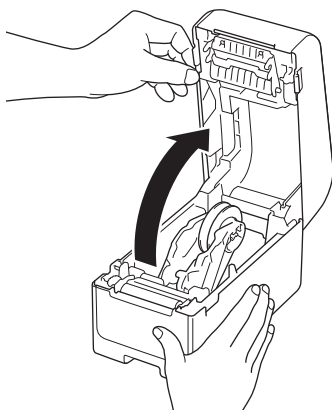

CAUTION

Do not touch the Tear Bar with your hands. Doing so may result in injury.

5. Rotate the Adjuster Dial to lock the Roll Guides in the appropriate position.

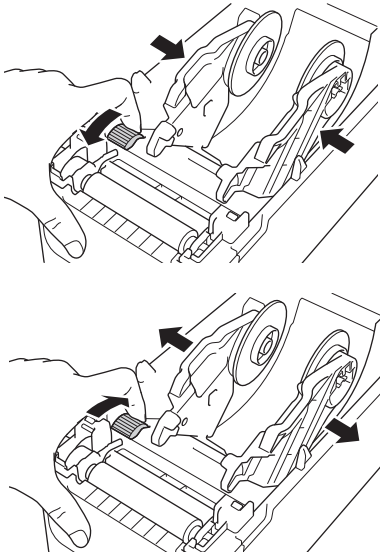

6. Insert the first label, printing surface facing up, through the Rear Feed Port. ¹

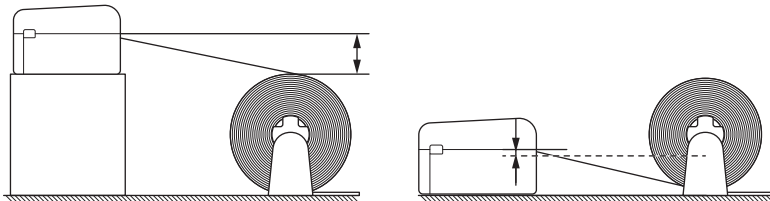

NOTE

- Position the printer and the external roll holder so that the top of the printer's Rear Feed Port is higher than the media roll's pull-out position.

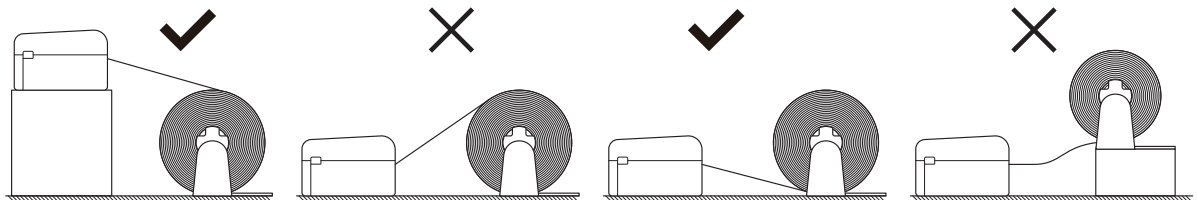

- Place the roll with the printing surface facing up.
- Do not allow external roll to touch any cables attached to the printer.
- Depending on the roll size and installation method, the roll may become overloaded and cannot feed labels/media. If this happens, reduce the printing speed.
- Make sure the labels pass under the Media Roll Holder, as shown in the illustration.

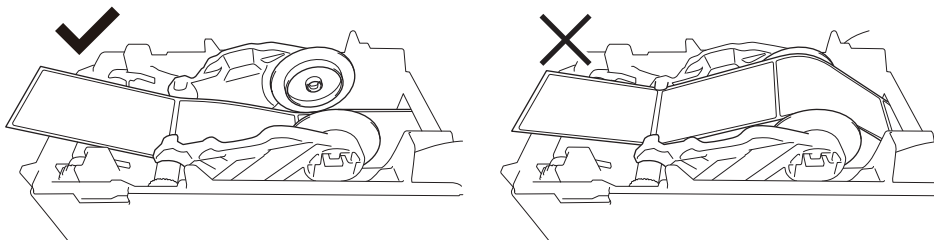

7. Feed the end of the backing paper under the Media Guide Tips (1).

Make sure the label extends slightly out of the Label Exit Slot.

¹ When printing die-cut labels, make sure that the label pull-out position is lower than the Rear Feed Port. If fed from above, the front edge of a die-cut label could catch on the upper part of the Rear Feed Port, peel from its backing, and jam the printer. We recommend checking the roll each time you print die-cut labels to confirm the correct label pull-out position and the Rear Feed Port height, as shown in the illustration.

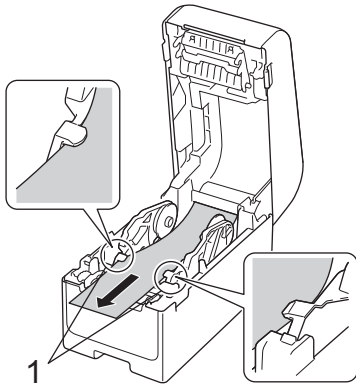

8. Close the Roll Compartment Cover until it locks into place.

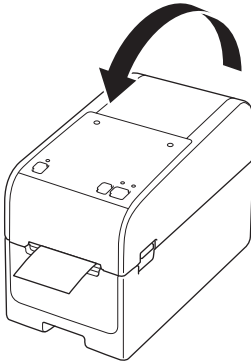

⚠ CAUTION

Be careful when closing the Roll Compartment Cover. There is a risk of injury if your finger gets pinched between the upper and lower parts of the cover.

IMPORTANT

- Do not leave any printed labels in the printer. Doing so will cause label jams.
- When the printer is not in use, remove any media from it and close the Roll Compartment Cover.

✓ Related Information

- [Load Media Roll](#)

Load a Roll in a Printer with a Peeler Unit

1. Press and hold  to turn the printer off.
2. Pull up the release levers on both sides of the printer to unlock the Roll Compartment Cover.

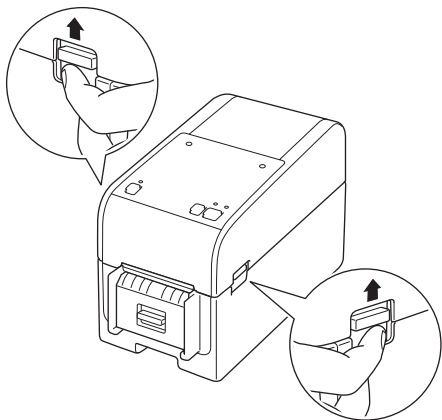

3. Hold the front of the printer, and firmly lift the Roll Compartment Cover to open it.

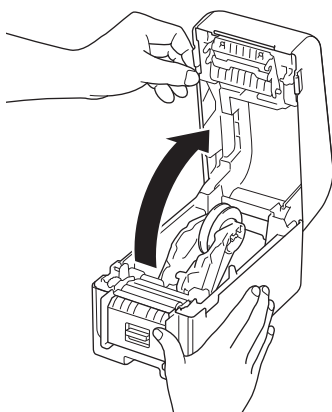

CAUTION

Do not touch the Tear Bar with your hands. Doing so may result in injury.

4. Slide both Roll Guides outwards.

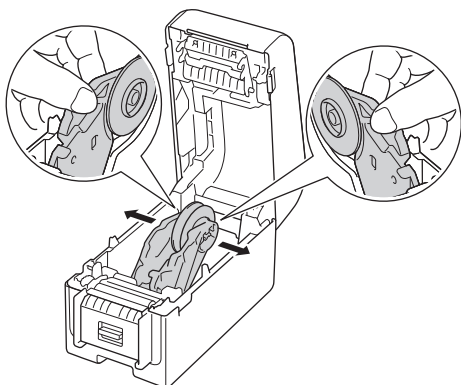

5. Insert the roll so that the label's printing surface is facing up, as shown in the illustration.

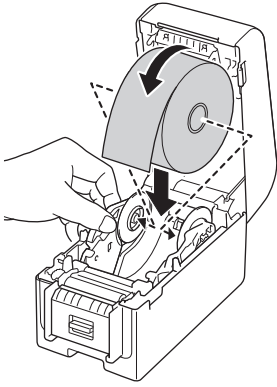

 Rotate the Adjuster Dial to lock the Roll Guides in the appropriate position.

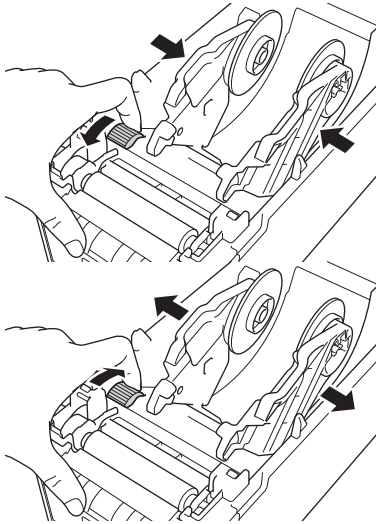

6. Peel off the first label from front to back.

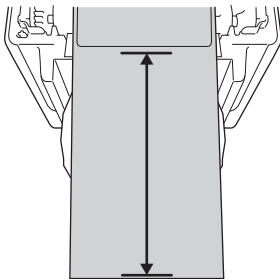

 A distance of 100 mm or more is recommended from the tip of the backing paper to the tip of the label.

7. Feed the end of the backing paper under the Media Guide Tips (1).

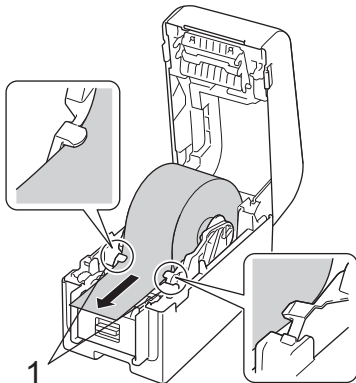

NOTE

When using media with a width of 22.9 mm or less, make sure the media exiting from the Label Exit Slot is not tilted to avoid labels being fed diagonally.

Top View

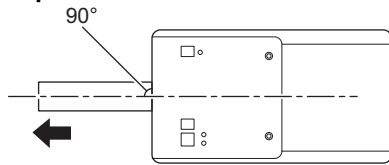

8. Open the Peeler Door.

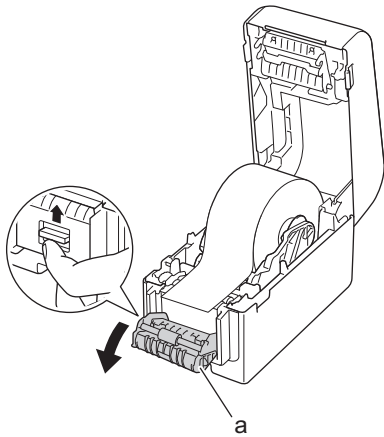

a. Peeler Door

9. Pass the edge of the backing paper through the Peeler Door slot.

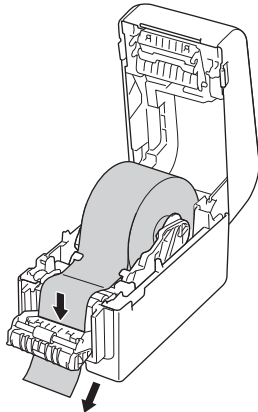

10. Close the Peeler Door.

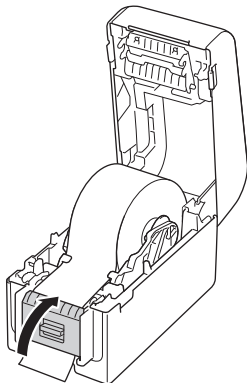

11. Close the Roll Compartment Cover until it locks into place.

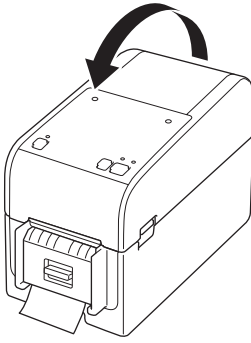

CAUTION

Be careful when closing the Roll Compartment Cover. There is a risk of injury if your finger gets pinched between the upper and lower parts of the cover.

12. Gently pull the backing paper coming out of the Release Paper Outlet until it stops. This minimizes slack in the roll.

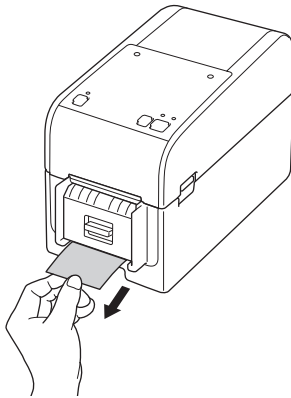

13. Set the printer driver peeler option on your computer.
- Select the **Use Peeler Function** checkbox on the printer driver.
 - Click **OK**.

IMPORTANT

- Do not leave any printed labels in the printer. Doing so will cause label jams.
- When the printer is not in use, remove any rolls from it and close the Roll Compartment Cover.

Related Information

- [Load Media Roll](#)

Load a Roll in a Printer with a Cutter Unit



For labels longer than 100 mm, install the Label Support.

1. Press and hold  to turn the printer off.
2. Pull up the release levers on both sides of the printer to unlock the Roll Compartment Cover.

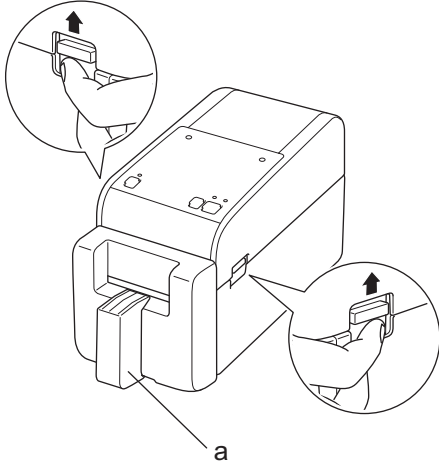

a. Label Support

3. Hold the front of the printer, and firmly lift the Roll Compartment Cover to open it.

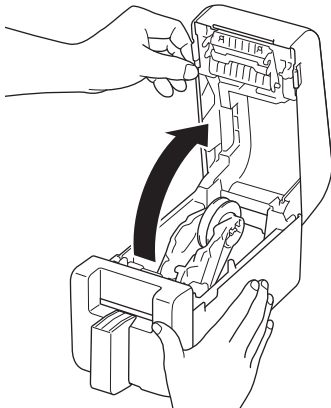

CAUTION

Do not touch the Tear Bar with your hands. Doing so may result in injury.

4. Slide both Roll Guides outwards.

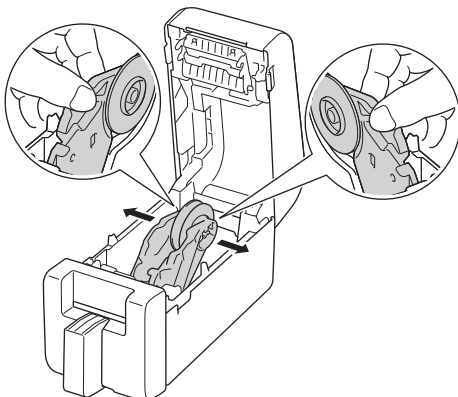

5. Insert the roll so that the label's printing surface is facing up, as shown in the illustration.

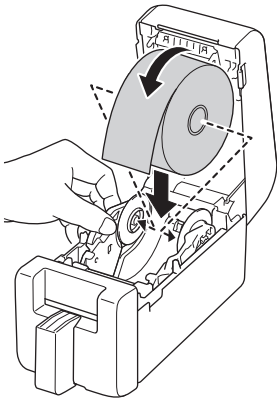

- Rotate the Adjuster Dial to lock the Roll Guides in the appropriate position.

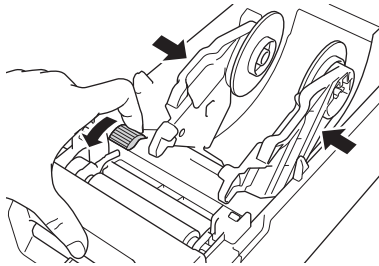

- When printing on continuous labels, wrinkles may occur, depending on the Roll being used and on the printing environment. If this happens, rotate the Adjuster Dial toward the rear of the printer to increase the space between the Roll Guides.

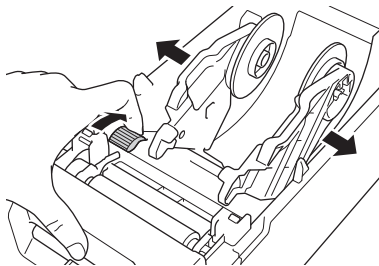

6. Feed the end of the backing paper under the Media Guide Tips (1).

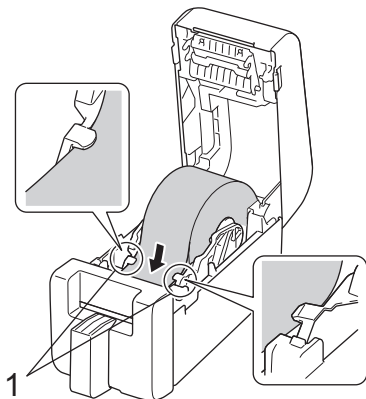

NOTE

When using media with a width of 22.9 mm or less, make sure the media exiting from the Label Exit Slot is not tilted to avoid labels being fed diagonally.

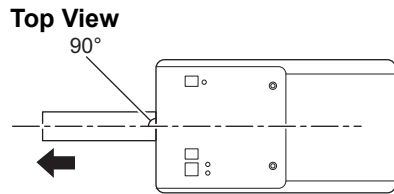

7. Feed the end of the roll through the Cutter Slot.

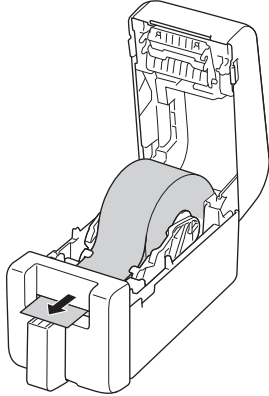

8. Close the Roll Compartment Cover until it locks into place.

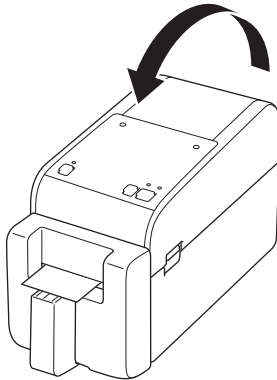

CAUTION

Be careful when closing the Roll Compartment Cover. There is a risk of injury if your finger gets pinched between the upper and lower parts of the cover.

IMPORTANT

- Do not leave any printed labels in the printer. Doing so will cause label jams.
- When the printer is not in use, remove any rolls from it and close the Roll Compartment Cover.

Related Information

- [Load Media Roll](#)

Load a Linerless Roll

To view all supported media rolls, import the Supported Linerless Roll list from **Paper Size Setup** in the Printer Setting Tool. For more information, see *Related Topics: Printer Setting Tool (Windows): Paper Size Setup*. You can also visit <https://support.brother.com/g/d/f4fi/> to download the Supported Linerless Roll list.

1. Press and hold  to turn the printer off.
2. Pull up the release levers on both sides of the printer to unlock the Roll Compartment Cover.

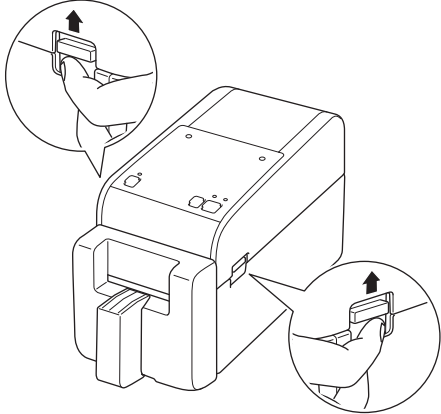

3. Hold the front of the printer, and firmly lift the Roll Compartment Cover to open it.

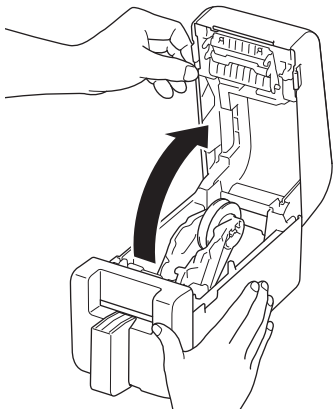

CAUTION

Do not touch the Tear Bar with your hands. Doing so may result in injury.

4. Rotate the Adjuster Dial to lock the Roll Guides in the appropriate position.

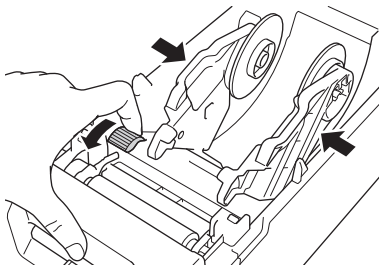

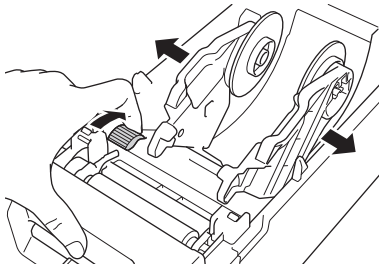

5. Insert the roll so that the label's printing surface is facing up, as shown in the illustration.

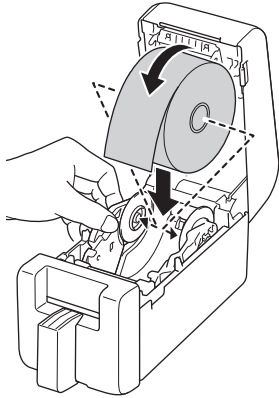

6. Feed the end of the backing paper under the Media Guide Tips (1).

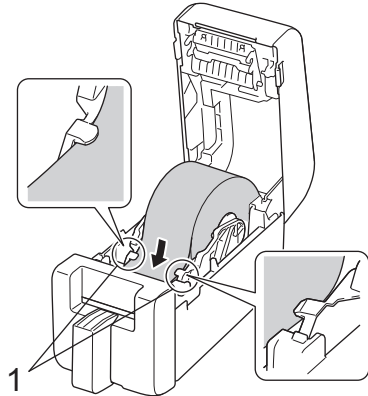

7. Feed the end of the roll through the Cutter Slot.

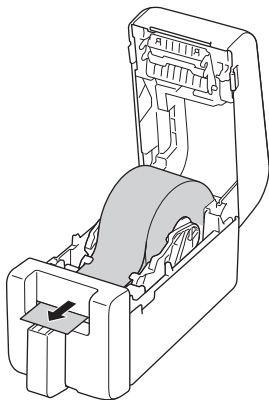

8. Close the Roll Compartment Cover until it locks into place.

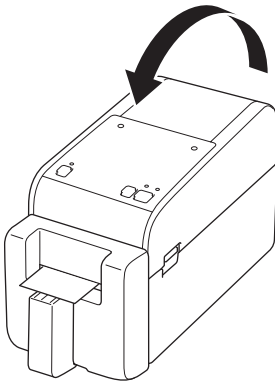

CAUTION

Be careful when closing the Roll Compartment Cover. There is a risk of injury if your finger gets pinched between the upper and lower parts of the cover.

IMPORTANT

- Do not leave any printed labels in the printer. Doing so will cause label jams.
 - When the printer is not in use, remove any rolls from it and close the Roll Compartment Cover.
-

NOTE

- When printing multiple labels, always remove the most recently-printed label to allow the next label to print.
 - If roll paper is jammed inside the Printer, open the Roll Compartment Cover and gently remove the paper. Do not use force to pull the paper out of the machine.
-

Related Information

- [Load Media Roll](#)

Related Topics:

- [Printer Setting Tool \(Windows\): Paper Size Setup](#)
-

Adjust the Sensor Position

When using any media, you must adjust the printer's sensor position based on the type of media you are using. You can use other types of rolls in addition to the Media Rolls described in this guide.

- >> [Sensor Position For Die-cut Labels without Black Marks](#)
- >> [Sensor Position For Die-cut Labels with Black Marks](#)
- >> [Sensor Position For Receipt Paper without Black Marks](#)
- >> [Sensor Position For Media with Black Marks](#)
- >> [Sensor Position for Media With Holes](#)
- >> [Sensor Position for Wristbands](#)

Sensor Position For Die-cut Labels without Black Marks

The transmissive/gap sensor detects the beginning of the label and feeds the label to the correct position. Align the slider with ▼ on the printer. When it is set in the correct position, you will hear a click.

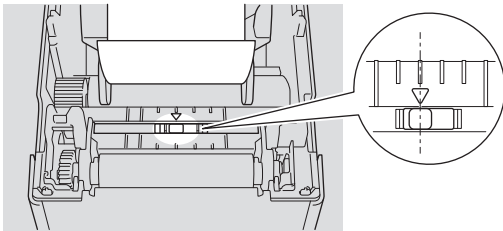

Sensor Position For Die-cut Labels with Black Marks

The Reflective/black mark sensor detects the mark and feeds the media to the correct position. Align the slider as shown in the illustration.

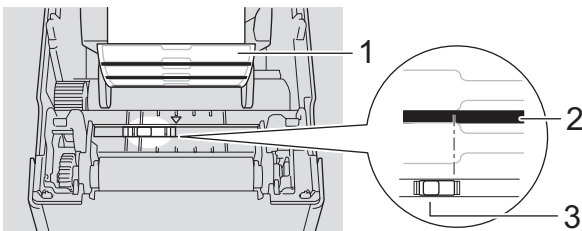

1. Back of media
2. Black mark
3. Reflective/black mark sensor



Make sure the reflective/black mark sensor is not set to the gap position of the label.

Sensor Position For Receipt Paper without Black Marks

The reflective/black mark sensor detects if paper roll is finished.

Align the slider with ▼ on the printer. When it is set in the correct position, you will hear a click.

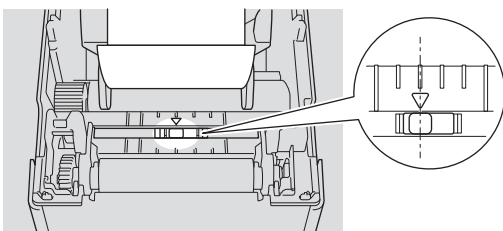

Sensor Position For Media with Black Marks

The Reflective/black mark sensor detects the mark and feeds the media to the correct position.

Align the slider with the centre of the thick black marks, as shown in the illustration.

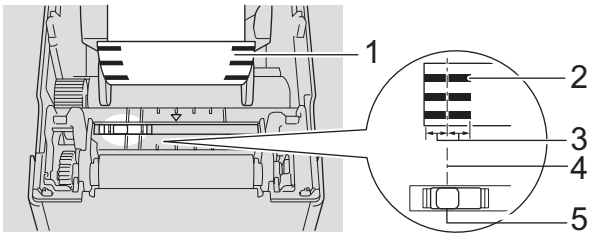

1. Back of media
2. Black mark
3. 4 mm or more

Make sure there is at least 4 mm on the left and right of the centre of the black mark.

4. Centre alignment of the black mark
5. Reflective/black mark sensor



When using media (maximum width: 63 mm), make sure the black marks are at least 8 mm long and either extend beyond the red dashed line into the blue-shaded area or are entirely in the blue-shaded area, as shown in the illustration. Unless the above conditions are met, the Reflective/black mark sensor will not detect the black marks.

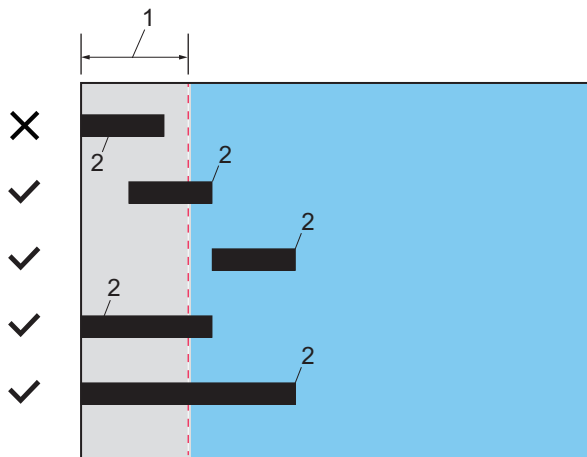

The illustration shows an example, when the sensor is on the left side.

1. 10 mm
2. Black mark: Minimum length 8 mm

Sensor Position for Media With Holes

The reflective/black mark sensor detects the hole and feeds the media to the correct position.

Align the slider as shown in the illustration.

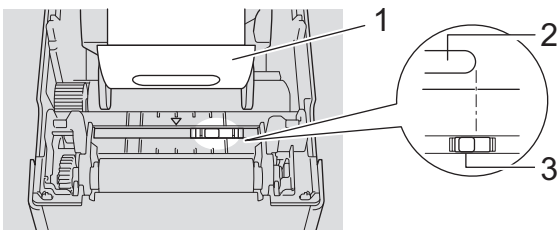

1. Back of media
2. Hole in media
3. Reflective/black mark sensor

Sensor Position for Wristbands

The Reflective/black mark sensor detects the mark and feeds the media to the correct position.

Align the slider as shown in the illustration.

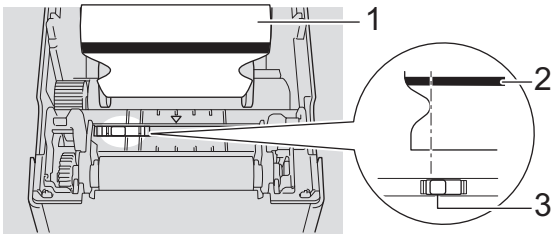

1. Back of media
2. Black mark
3. Reflective/black mark sensor



If an error, such as the wristband feed not stopping occurs, try the Auto Media Configuration Function. If this function does not fix the issue, adjust the Reflective/black mark sensor's detection level manually.



Related Information

- [Set Up Your Printer](#)

Related Topics:

- [Printer Setting Tool \(Windows\): Device Settings](#)
 - [Printer Setting Tool \(Windows\): Paper Size Setup](#)
 - [Auto Media Configuration](#)
-

Connect the Power Cord

1. Connect the AC Adapter to the printer.
2. Connect the AC Power Cord to the AC Adapter.
3. Connect the AC Adapter plug to a nearby electrical socket (AC 100 - 240 V, 50/60 Hz).

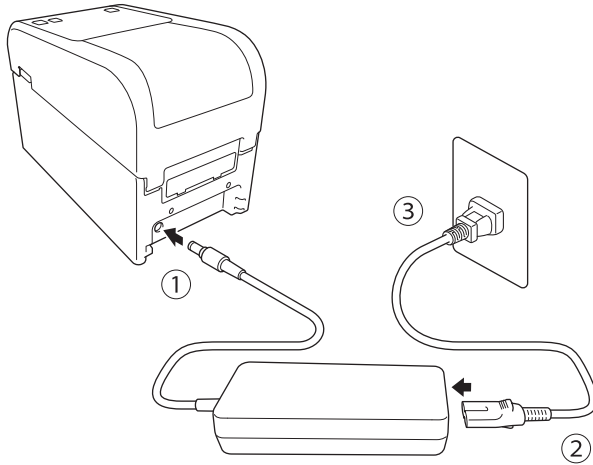

Related Information

- [Set Up Your Printer](#)

Turn Power On/Off

- To turn the printer on, press .



Press  to align the end of the roll.

The Power LED turns green.

- To turn the printer off, press and hold  until the Power LED turns off.

NOTE

When turning the printer off, do not disconnect the AC Adapter and AC Power Cord until the Power LED turns off.



Related Information

- [Set Up Your Printer](#)

Use the Printer's Power Supply Function

Related Models: TD-2320D/TD-2350D/TD-2320DF/TD-2350DF/TD-2320DSA/TD-2350DSA

This printer offers USB Power Delivery (USB PD) powering when you connect other devices to its USB port. The power supply function should not be used in place of an actual power charger. It is designed only to keep devices that you connect to the printer powered on while connected.

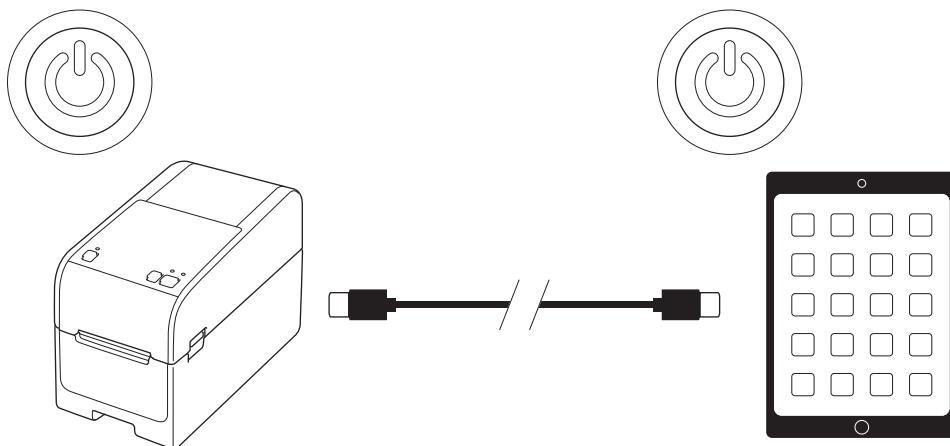

- Turn on both the printer and the device you want to supply power to, then connect them using a USB PD cable.
- This printer's power supply function powers compatible USB PD devices up to 15W.
- The USB cable provided with this product is meant for communication use only, and cannot power other devices. To use the power supply function, use a compatible USB PD cable (not included).
- When using this product to provide power to an iOS/iPadOS device, use the cable that comes with the iOS/iPadOS device.
- This function does not guarantee the powering of all USB PD-compatible devices. Make sure the connected device is receiving power when use.
- Some USB cables may not be able to supply sufficient power to connected devices.
- Use a USB-C® to USB-C cable with a length of 2m or less (not included).

✓ Related Information

- [Set Up Your Printer](#)

Update and Back Up Data using USB Flash Drive

Related Models: TD-2350D/TD-2350DF/TD-2320DSA/TD-2350DSA

You can use a USB flash drive to update templates and databases, obtain printer settings, and copy the settings to other printers.



USB flash drives with security features may not work correctly.

>> [Update Templates and Databases](#)

>> [Retrieve Printer Settings and Copy Them To Other Printers](#)

Update Templates and Databases

1. Convert the template (LBX file) or database (for example, an Excel file) you want to update into a transferable file format (BLF or BIN).

To convert files using P-touch Editor, do the following:

- a. Click **File** > **Transfer Template**, and then select **Export**.
- b. Save the file in the BLF format.

2. Store the BLF or BIN files on a USB flash drive.
3. Insert the USB flash drive into the USB port on the printer.
4. Press **Menu**, and then select [Settings] > [USB Flash Drive] > [Remote Update] to update data on the printer.

Retrieve Printer Settings and Copy Them To Other Printers

1. Insert a USB flash drive into the USB port on the printer you intend to retrieve the printer settings from. (Referred to as Printer 1 in the steps below.)
2. Press **Menu**, and then select [Settings] > [USB Flash Drive] > [Backup].
3. When Printer 1 prompts you to enter the printer's password, enter the password for this printer.
4. Remove the USB flash drive from Printer 1 and insert it into the USB port on the printer you intend to copy the settings to. (Referred to as Printer 2 in the steps below.)
5. Press **Menu**, and then select [Settings] > [USB Flash Drive] > [Restore].
6. When Printer 2 prompts you to enter the printer's password, enter the password for this printer.
7. When Printer 2 prompts you to enter the data password, enter the password for Printer 1.

NOTE

- The printer's password contains alphanumeric characters and is located on the nameplate on the bottom of the printer marked "Pwd".
The password can be changed using BRConfiguration Tool or Web based Management.
- If Printer 1 and Printer 2 have different firmware versions, they may not work correctly.
To check the printer firmware version, press **Menu**, and then select [Information] > [Configuration].



Related Information

- [Set Up Your Printer](#)

Related Topics:

- [LCD Overview](#)

Install Software

- [Install Printer Drivers and Software on a Computer](#)
- [Connect the Printer to a Computer](#)

Install Printer Drivers and Software on a Computer

To print from your computer, install the printer driver and P-touch Editor to your computer.

1. In the address bar, type install.brother and download the Software/Documentation installer.

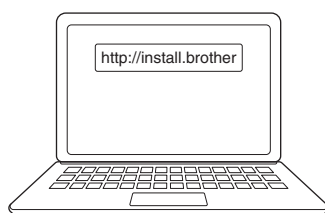

2. Double-click the downloaded installer, and follow the on-screen instructions.

NOTE

- To use your printer's advanced features, select the additional software you want during installation.
- When you connect the printer to your computer using Bluetooth, make sure you set the Bluetooth data transfer setting in your operating system to bi-directional.



TD-2350D/TD-2350DF/TD-2350DSA:

To connect the printer to a computer using a wireless connection, we recommend the following:

- When you turn the printer on for the first time after purchasing it or resetting it, the printer automatically enters wireless settings mode. Start the software download and installation when the printer enters this mode.
- Make a note of the SSID (network name) and password (network key) of the wireless network in advance. If you cannot find this information, contact your network administrator or wireless access point/router manufacturer.
- To connect the printer to a computer using Wireless Direct, select USB connection during the installation. At the end of the installation, click the link for Wireless Direct.



TD-2320D/TD-2350D/TD-2320DF/TD-2350DF/TD-2320DSA/TD-2350DSA:

To use the printer with a different connection method than the one selected during installation, use the installer again to reinstall the software and printer drivers, and select the new connection method.



Related Information

- [Install Software](#)
 - [Available Applications](#)

Available Applications

Windows

Application	Features
P-touch Editor	Allows you to design and print custom labels using built-in drawing tools to create various font and text styles, and to import images and insert barcodes.
P-touch Transfer Express	Allows you to transfer documents to the printer. To download the installer, go to your model's Downloads page on the Brother support website at support.brother.com .
P-touch Update Software	Updates software and firmware to the latest version.
Printer Setting Tool	Allows you to configure the printer's settings from a computer. <ul style="list-style-type: none"> • Communication Settings • Device Settings • P-touch Template Settings • Paper Size Setup
BRAdmin Professional	Finds the printer on your network and allows you to configure advanced settings and updates from your computer.
Font Manager	Allows you to transfer fonts to the printer and delete fonts from the printer. Use various print commands to access and print using transferred fonts. A Font Manager is available from the Brother Developer Center (https://support.brother.com/g/s/es/dev/en/index.html).  Font Permissions When using fonts, you must abide by all the terms and conditions set forth by each rightful font owner. Before downloading fonts, you must confirm that you have legitimate licences to use the fonts and comply with their terms and conditions.
Status Monitor (TD-2320D/ TD-2350D/ TD-2320DF/ TD-2350DF/ TD-2320DSA/ TD-2350DSA)	Allows you to check the machine status from your computer. The Status Monitor utility is installed automatically when you install the printer driver.
LabelCLT (Command Line Tool)	Allows you to transfer firmware to a USB-connected or networked printer. Templates and configuration files saved by each tool can be transferred to the printer. To download LabelCLT, go to your model's Downloads page on the Brother support website at support.brother.com .

✓ Related Information

- [Install Printer Drivers and Software on a Computer](#)

Connect the Printer to a Computer

- [Connect the Printer to a Computer Using a USB Cable](#)
- [Connect the Printer to a Computer Using Wi-Fi](#)
- [Connect the Printer to a Computer Using a Wired LAN](#)
- [Connect the Printer to a Computer Using a Bluetooth Connection](#)
- [Connect the Printer to a Computer Using RS-232C](#)

Connect the Printer to a Computer Using a USB Cable

1. Make sure the printer is turned off before connecting the USB cable.
2. Connect the USB cable to the USB Port on the printer, and then to your computer.

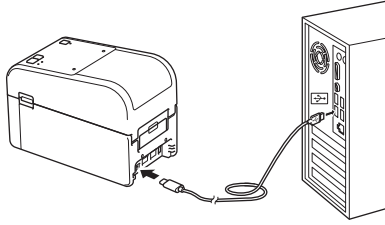

3. Turn the printer on.



Related Information

- [Connect the Printer to a Computer](#)

Connect the Printer to a Computer Using Wi-Fi

Related Models: TD-2350D/TD-2350DF/TD-2350DSA

The following Wi-Fi® connection methods are available:

- >> [Using a Wi-Fi Router/Access Point \(Infrastructure Mode\)](#)
- >> [Without Using a Wi-Fi Router/Access Point \(Wireless Direct\)](#)
- >> [Using WPS \(Wi-Fi Protected Setup™\)](#)

Using a Wi-Fi Router/Access Point (Infrastructure Mode)

Infrastructure Mode allows you to connect the printer to a computer or mobile device via a Wi-Fi router/access point.

Before You Begin

First, configure the printer's Wi-Fi settings to communicate with your Wi-Fi router/access point. After the printer is configured, the computers and mobile devices on your network will have access to the printer.

- Before connecting the printer to your network, contact your system administrator to confirm your Wi-Fi network settings.
- To reconfigure the Wi-Fi settings, or if the status of the printer's Wi-Fi connection is unknown, reset the printer's Wi-Fi settings.

To reset the printer's Wi-Fi settings, see *Related Topics: Reset the Printer*.

- For best results with everyday printing, put the printer as close to the Wi-Fi router/access point as possible with minimal obstructions. Large objects and walls between the two devices and interference from other electronic devices can affect the transfer speed of print data.

1. Write down your Wi-Fi router/access point's SSID (Network Name) and Password (Network Key).
2. On the printer, press **Menu**, and then press ▲ or ▼ to select the following:

- a. Select [WLAN]. Press **OK**.
- b. Select [WLAN (On/Off)]. Press **OK**.
- c. Select [On]. Press **OK**.

3. Configure the printer's Infrastructure Mode settings:

On the printer, press the **Menu**, and then press ▲ or ▼ to select the following:

- a. Select [WLAN]. Press **OK**.
- b. Select [Network Mode]. Press **OK**.
- c. Select [Infrastructure Mode]. Press **OK**.
- d. Select [WLAN]. Press **OK**.
- e. Select [Infra Manual Setup]. Press **OK**, and follow the on-screen instructions.

When the connection between the printer and your Wi-Fi router/access point is established, the  (Wi-Fi) icon appears on the printer's LCD. Computers and mobile devices that are on the same network as the printer now have access to the printer.

Without Using a Wi-Fi Router/Access Point (Wireless Direct)

Wireless Direct allows you to connect the printer to your computer or mobile device directly, without a Wi-Fi router/access point. The printer serves as a Wi-Fi access point.

1. Confirm the printer's Wireless Direct settings:

On the printer, press **Menu**, and then press ▲ or ▼ to select the following:

- a. Select [WLAN]. Press **OK**.

b. Select [Network Mode]. Press **OK**.

c. Select [Direct Mode]. Press **OK**.

The Wireless Direct icon,  or  appears on the LCD.

2. On the printer, press **Menu**, and then press **▲** or **▼** to select the following:

a. Select [WLAN]. Press **OK**.

b. Select [WLAN (On/Off)]. Press **OK**.

c. Select [On]. Press **OK**.

d. Select [WLAN]. Press **OK**.

e. Select [WLAN Status]. Press **OK**.

f. Select [Direct Mode]. Press **OK**.

The Printer's SSID and the password appear on the LCD.

3. Use your computer or mobile device to select the printer's SSID and enter the password, if required.

- SSID: DIRECT-(serial number's last 5 digits)_TD-2350###

The serial number is located on the bottom of the printer or in the printer.

- Password: *****

Where ***** is the eight digits Wireless Direct Password indicated on the label on the bottom of the printer as "WDP".

NOTE

- The Printer Setting Tool also allows you to apply the network settings to multiple printers.
- You cannot connect to the Internet via Wi-Fi while using Wireless Direct. To use the Internet, connect using a Wi-Fi router/access point (Infrastructure Mode).
- We recommend setting a new Wireless Direct password using the Printer Setting Tool to protect your printer from unauthorised access.

Using WPS (Wi-Fi Protected Setup™)

1. Confirm that your Wi-Fi router/access point features the WPS symbol.



2. Place the printer within range of your Wi-Fi router/access point.

The range may differ depending on your environment. See the instructions provided with your Wi-Fi router/access point.

3. Press the WPS button on your Wi-Fi router/access point.

4. On the printer, press **Menu**, and then press **▲** or **▼** to select the following:

a. Select [WLAN]. Press **OK**.

b. Select [WPS Button Push] or [WPS PIN Code]. Press **OK**.

c. If the Selection Menu appears, select [Start].

d. Press **OK**.

When a connection is established, the WLAN icon appears on the printer's LCD. Computers and mobile devices that are on the same network as the printer will have access to the printer.



- The printer will try to connect using WPS for two minutes. If you press **OK** during that time, the printer will continue trying to connect for an additional two minutes.
 - If your computer or mobile device supports the PIN authentication method, select [WPS PIN Code] for better security.
-



Related Information

- [Connect the Printer to a Computer](#)

Related Topics:

- [Confirm Printer Settings](#)
 - [Reset the Printer](#)
-

Connect the Printer to a Computer Using a Wired LAN

Related Models: TD-2320D/TD-2350D/TD-2320DF/TD-2350DF/TD-2320DSA/TD-2350DSA

To use a static IP address to connect your printer with a wired LAN connection, install the printer drivers and Printer Setting Tool, and then specify the wired LAN connection settings.

Network Cable

Use a straight-through Category 5 (or greater) twisted-pair cable for 10BASE-T or 100BASE-TX Fast Ethernet Network.

IMPORTANT

Do not connect this product to any LAN connection that is subject to overvoltages.

1. Make sure the Wireless LAN setting on your printer is turned off.
2. If on-screen instructions appear during the installation, make sure the printer is turned off before connecting the LAN cable.
3. Connect the LAN cable to the LAN Port on the back of the printer.
4. Turn the printer on.





Related Information



- [Connect the Printer to a Computer](#)

Connect the Printer to a Computer Using a Bluetooth Connection

Related Models: TD-2350D/TD-2350DF/TD-2350DSA

1. On the printer, press the **Menu**, and then press ▲ or ▼ to select the following:
 - a. Select [Bluetooth]. Press **OK**.
 - b. Select [Bluetooth (On/Off)]. Press **OK**.
2. Press ▲ or ▼ to select [On]. Press **OK**.
 appears on the LCD.
3. Use your device's Bluetooth management software to discover the printer. Select the printer's name.
4. When your printer is connected successfully, the icon colors change from  to .



TD-2350DSA: Depending on your model, the Bluetooth icons will appear as  for .



Related Information

- [Connect the Printer to a Computer](#)

Connect the Printer to a Computer Using RS-232C

Connection using RS-232C requires the use of a dedicated conversion cable (PA-SCA-002).

1. Start the Printer Setting Tool.
Click **Start > Brother > Printer Setting Tool**.
2. Click **P-touch Template Settings > Communication Settings**.
3. Set parameters in the **Communication Settings** window as follows:

Baud rate	From 4800 bps to 115200 bps
Bit Length	7 bits or 8 bits
Parity	None, Odd, or Even
Busy Control	DTR or XON/XOFF



Other settings, such as the baud rate, must be changed in order to use a RS-232C connection. The settings for this printer's serial port are shown in the table above.

4. Click the **Set** button to save the parameters.



Related Information

- [Connect the Printer to a Computer](#)

Create and Print Labels Using Your Computer

- [Create and Print Labels Using P-touch Editor \(Windows\)](#)
- [Tips for Better Printing Results When Using P-touch Editor](#)
- [Create Labels and Print without Installing Software and Drivers](#)
- [Print Labels Distributed to Multiple Printers to Reduce Printing Time \(Windows\)](#)
- [Print Barcode Labels Using Crop Print \(Windows, 300 DPI Printer Only\)](#)
- [Print Labels Using the Printer Driver \(Windows\)](#)

Create and Print Labels Using P-touch Editor (Windows)

To use your printer with your Windows computer, install your model's printer driver and P-touch Editor on your computer.

For the latest drivers and software, go to your model's **Downloads** page at support.brother.com/downloads.

1. Start P-touch Editor .

Click **Start > Brother P-touch > P-touch Editor**, or double-click the **P-touch Editor** icon on the desktop.

NOTE

Depending on your computer's operating system, the Brother P-touch folder may or may not be created.

2. Make sure your model's name is selected on the Home screen.
3. Do one of the following:
 - To create a new layout, click the **New Label** tab, and then click the **New Label** button (1).
 - To create a new layout using a preset layout, click the **New Label** tab, and then click a category button (2), select a template, and then click **Create** (3).
 - To open an existing layout, click **Open** (4).

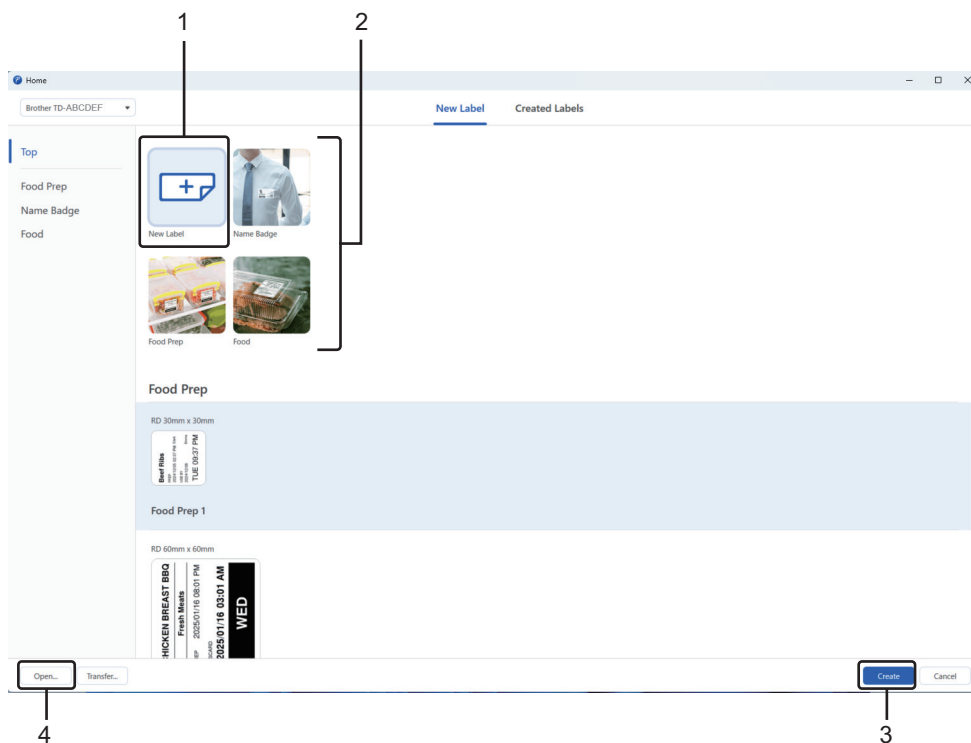

4. Click the **Print** icon.
5. Select the print settings you want, and then click **Print**.



To change how P-touch Editor starts, open P-touch Editor and click **File > Options**. Select the **Mode** option on the left side of the screen, and then select the **Home/Office** or **Electrical/Network** option. Click **OK** to apply the setting.



Related Information

- [Create and Print Labels Using Your Computer](#)
 - [Main Window of P-touch Editor \(Windows\)](#)

Main Window of P-touch Editor (Windows)

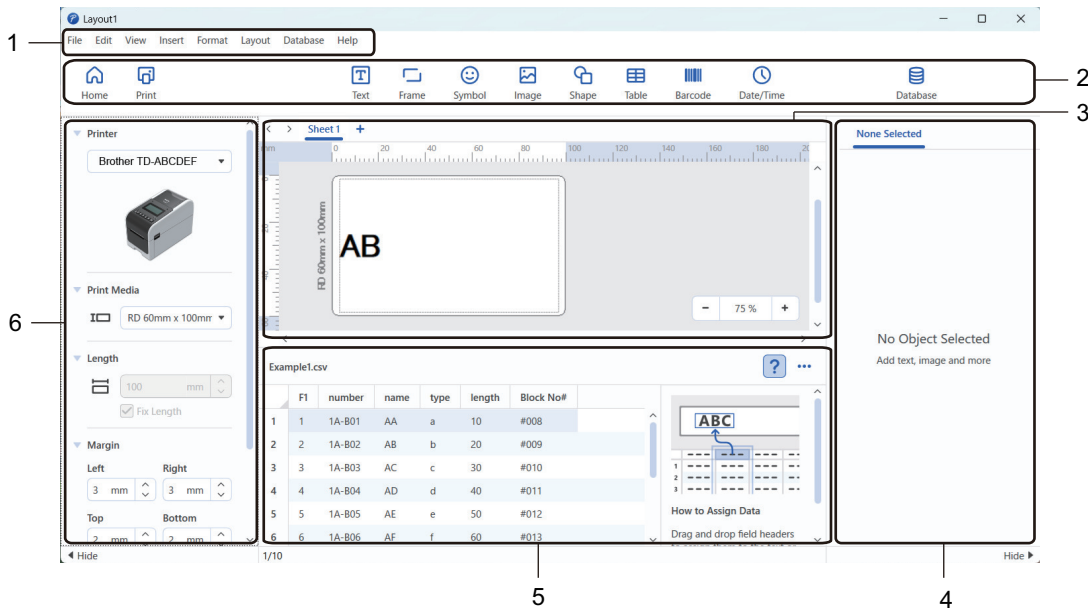

1. Menu Bar
2. Toolbar
3. Layout Window
4. Object Inspector
5. Database Connection Area
6. Label Inspector

✓ Related Information

- [Create and Print Labels Using P-touch Editor \(Windows\)](#)

Tips for Better Printing Results When Using P-touch Editor

1. Font Substitution

When creating a label template in P-touch Editor, if you use a font that the printer does not support, the printer will substitute one of its built-in fonts, and the print result will be different from the label image shown in P-touch Editor.

To prevent font substitution, select a font already installed in the printer, or transfer the font you want to use to the printer.

For information on how to transfer fonts, visit your model's **FAQs & Troubleshooting** page at support.brother.com.

2. Other Factors

There are other factors that may cause printing results to differ from the label image displayed in P-touch Editor. For more information, visit your model's **FAQs & Troubleshooting** page on support.brother.com.



Related Information

- [Create and Print Labels Using Your Computer](#)
-

Create Labels and Print without Installing Software and Drivers

- [Print Using a USB Interface \(Mass Storage Mode\)](#)
- [Notes on Printing Images without Using the Printer Driver](#)

Print Using a USB Interface (Mass Storage Mode)



The mass storage feature allows you to send a file to the printer using the USB interface, without installing a printer driver.

This feature is useful for:

- Applying printer settings saved in a command file (BIN file format) and adding templates (BLF file format) into your printer without using any software tools. Both types of files must be distributed by an administrator.
- Executing commands without installing the printer driver.
- Using a device with an operating system (including non-Windows operating systems) supporting a USB host feature to print and transmit data.

1. Confirm that the printer is turned off.

2. Do one of the following:

- TD-2350D/TD-2350DF/TD-2320DSA/TD-2350DSA: Press and hold **OK** and  at the same time until the Power LED lights in green and [Mass Storage Mode] appears on the LCD.
- TD-2310D/TD-2320D/TD-2320DF: Press and hold  and  at the same time until the Power LED starts flashing in green.

3. Connect the computer or mobile device to the printer via USB.

The printer's mass storage area appears as a folder on the computer or device's screen.



If the mass storage area does not appear automatically, see the instructions for the operating system of your computer or mobile device for information about accessing the mass storage area.

4. Drag and drop the file you want to copy to the mass storage area.

5. Do one of the following:

- TD-2350D/TD-2350DF/TD-2320DSA/TD-2350DSA: Press **OK**.
The command file is executed, during which the Status LED flashes in green. When finished, the Power LED lights in green.
- TD-2310D/TD-2320D/TD-2320DF: Press .
The command file is executed, during which the Status LED flashes in green. When finished, the Power LED lights in green.

6. To turn Mass Storage Mode off, turn the printer off.

NOTE

- When the printer is turned off, Mass Storage Mode is deactivated and any files in the mass storage area are deleted.
- This feature supports only BIN, BLF and JPG files.
- Do not create folders in the mass storage area. If a folder is created, files in the folder cannot be accessed.
- Mass Storage maximum capacity is 16 MB.
- If multiple files are copied, the commands may not be executed.
- Only USB connection is available while the printer is in Mass Storage Mode.
- Do not access other files in the mass storage area when executing a copied file.



Related Information

- [Create Labels and Print without Installing Software and Drivers](#)

Notes on Printing Images without Using the Printer Driver

Mass Storage Mode supports JPEG image printing. The printer converts colour JPEG files to monochrome using the dithering process, which could result in fuzzy images. To improve image quality, avoid or turn off any functions that preprocess images.



TD-2350D/TD-2350DF/TD-2350DSA:

Your printer supports an Object Push Profile (OPP) when printing via Bluetooth.

- Only JPEG images can be printed; this function is limited to files with the .jpg extension.
- The maximum file size is 16 MB (2 MB when the Mass Storage feature is used).
- The maximum resolutions are as follows:
 - Printers with 203 dpi print resolution:
Height × Width = 24,000 × 472 dots
 - Printers with 300 dpi print resolution:
Height × Width = 36,000 × 696 dots

If these limits are exceeded, the printer will reject the data and will not print the image.

- Print is at 1 pixel = 1 dot.
- The printer performs binary processing (simple binary) to print the image.
- Images are printed using the original data's height-to-width proportions.



Related Information

- [Create Labels and Print without Installing Software and Drivers](#)

Print Labels Distributed to Multiple Printers to Reduce Printing Time (Windows)

When printing a large number of labels, printing can be distributed among multiple printers to reduce printing time.



- The Distributed Printing function can only be used with printers of the same model number.
- The number of pages is divided among the selected printers. If the specified number of pages cannot be evenly divided among the printers, it is divided in the order of the printers as shown.

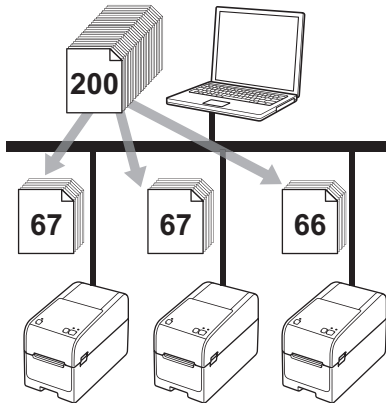

- It may not be possible to detect information for a printer connected via a USB hub or print server. Before printing, enter the settings manually, and check if the printer can be used for printing.
- TD-2320D/TD-2350D/TD-2320DF/TD-2350DF/TD-2320DSA/TD-2350DSA:
Depending on whether a router is used and the security features in use, such as a firewall, it may not be possible to use this function.
- We recommend performing a connection test for your operating environment. Contact your information technology manager or administrator for assistance.

1. In P-touch Editor, click **File > Print**.
2. Click **Properties**.
3. Click the **Advanced** tab, select the **Distributed Printing** checkbox, and then click **Settings**.

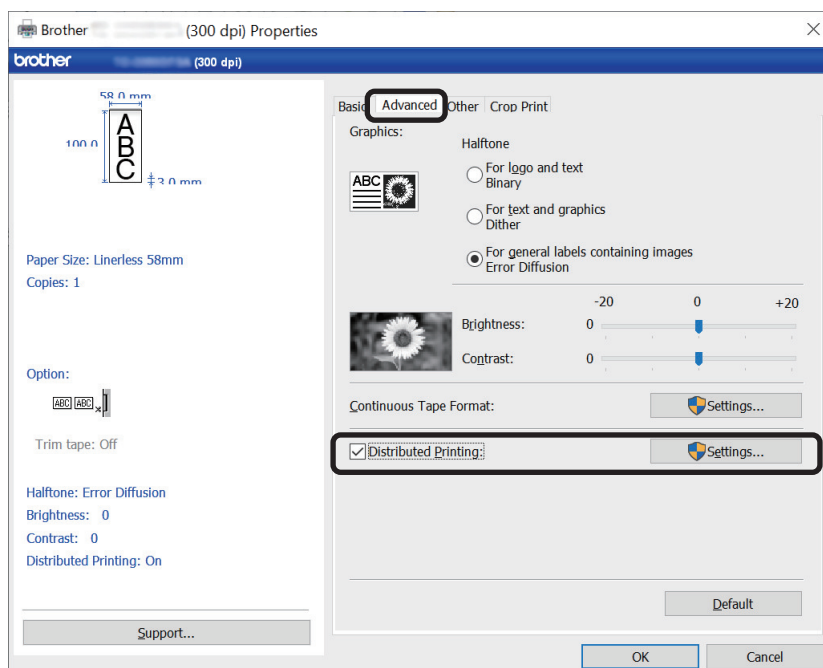

The Distributed Printing Settings dialog box appears.

Print Barcode Labels Using Crop Print (Windows, 300 DPI Printer Only)

You can print one or multiple barcodes from an A4 or Letter size PDF file. The Crop Print feature automatically identifies and then individually crops and prints the barcodes you specify.

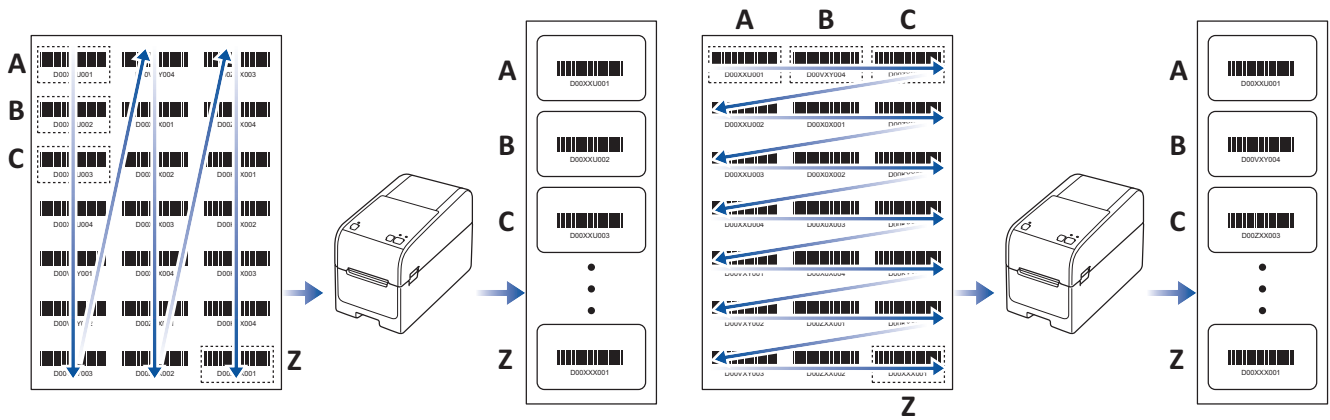

- The Crop Print function is available only when printing from the Windows printer driver, and cannot be executed using P-touch Editor.
- The accuracy of the Crop Print feature depends on the user's environment, printing material, and label content.
- Clear, black-and-white barcodes are recommended.
- Some labels may not print correctly or may differ from the original data if the conditions are not optimal.
- For more information, visit the Brother support website at support.brother.com.



Related Information

- [Create and Print Labels Using Your Computer](#)
 - [Barcodes Compatible with Crop Print \(Windows\)](#)
 - [Barcode Document Compatible with Crop Print \(Windows\)](#)
 - [Print Barcode Labels Using Crop Print \(Windows, 300 DPI Printer Only\)](#)

Barcodes Compatible with Crop Print (Windows)

Barcode Specification

Property	Specification
Vertical width	5 mm (minimum)
Horizontal width	The narrowest bar: 0.5 mm (minimum)
Margin	10 times the narrowest bar width (minimum)
Colour	Black
Background colour	White
Cell width (widest bar)	0.5 mm (minimum)

- Code 39/ Code 3 of 9
- ITF/ ITF-14/ Interleaved 2 of 5
- GS1-128 (UCC/ EAN-128)
- Codabar (Code 2 of 7, NW-7)
- CODE 93
- CODE 128
- UPC-A
- UPC-E
- JAN-8/ EAN-8
- JAN-13/ EAN-13
- QR code
- PDF417
- MaxiCode



Related Information

- [Print Barcode Labels Using Crop Print \(Windows, 300 DPI Printer Only\)](#)

Barcode Document Compatible with Crop Print (Windows)

To use the Crop Print function, create a barcode document and save it as a PDF file.

Make sure the final barcode PDF meets the following requirements:

Barcode Conditions for Product Labels

Item	Condition
Total barcode number	Between 1-99 barcodes
Barcode type	Use only barcodes compatible with the Crop Print feature.
Barcode position	<p>Make sure barcodes are not tilted or on an angle. They must be parallel with the top and bottom of each page.</p> <p>There are two ways to arrange bar codes: one that prioritizes the vertical direction, and the other that prioritizes the horizontal direction.</p> <ul style="list-style-type: none"> In vertical direction priority, barcodes start in the top left corner and run down the column to the bottom, continuing at the top of the next column to the right. In horizontal direction priority, barcodes start in the top left corner and run down the row to the right, continuing at the left end of the next row.

Barcode Layout for Product Labels

Correct Barcode Layout	Incorrect Barcode Layout
	<p>(not aligned along the top margin)</p>



Related Information

- [Print Barcode Labels Using Crop Print \(Windows, 300 DPI Printer Only\)](#)

Print Barcode Labels Using Crop Print (Windows, 300 DPI Printer Only)

TD-2320D/TD-2350D/TD-2320DF/TD-2350DF/TD-2320DSA/TD-2350DSA: Make sure your printer is connected to a computer or mobile device via a USB cable or network connection.

TD-2310D: Make sure your printer is connected to a computer or mobile device via a USB cable.

1. Open the barcode document PDF file you want to print.
2. Click **File > Print**.
3. Click the **Printer** drop-down list, and then select your printer.
4. In the **Page Sizing & Handling** section, select the **Actual Size** radio button.
5. Under **Orientation**, select the **Portrait** radio button.
6. Click **Properties**.
7. Click the **Basic** tab, and do one of the following:
 - For Die-cut labels, clear the **Cut Every** checkbox.
 - For Continuous Rolls, select the **Cut Every** checkbox.

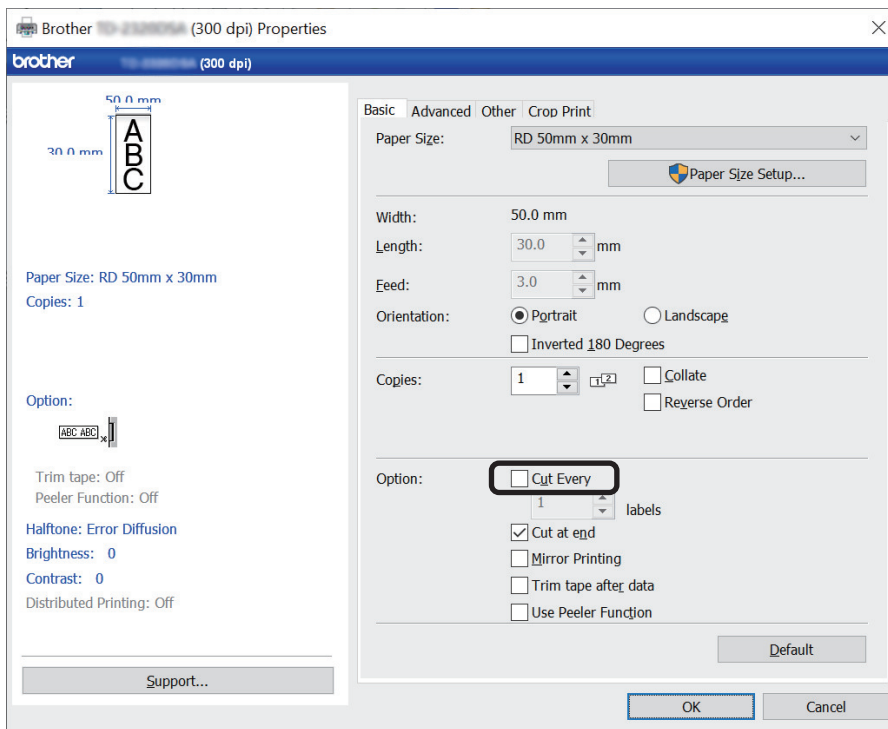

8. Click the **Crop Print** tab, and select the **Automatically print individual labels with barcodes.** checkbox.

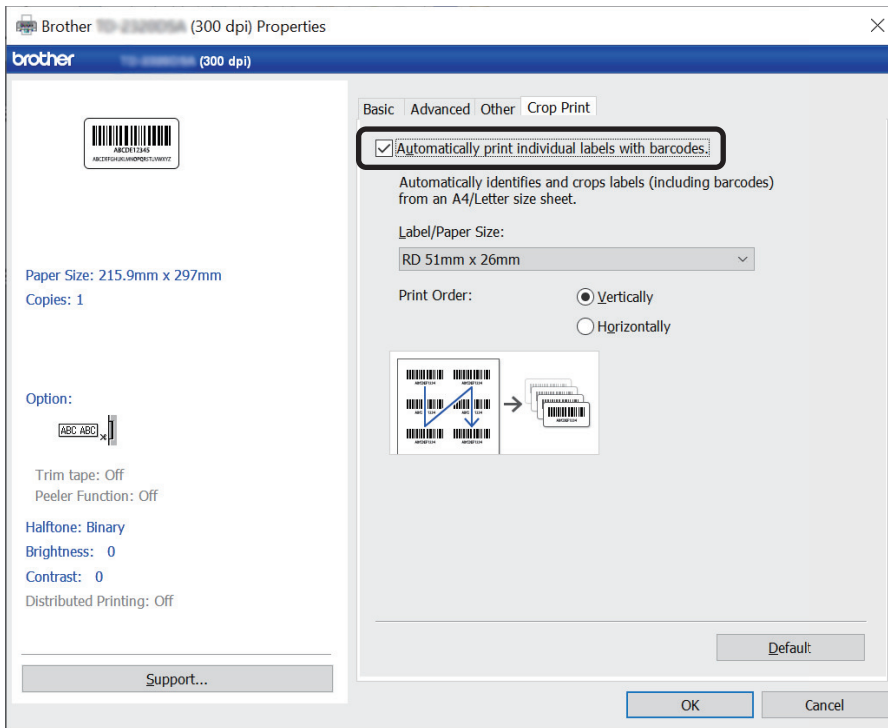

9. Click the **Label/Paper Size** drop-down list, and then select your label or paper size.

10. Click **OK**.

11. Print from the application's print screen.



- Do not enlarge or reduce the size of the barcode sheet. The barcodes may not be identified correctly.
- When printing from Acrobat Reader®, do the following:
 - In the **Page Sizing & Handling** section, clear the **Choose paper source by PDF page size** checkbox.
 - Under **Orientation**, select the **Portrait** radio button.



Related Information

- [Print Barcode Labels Using Crop Print \(Windows, 300 DPI Printer Only\)](#)

Print Labels Using the Printer Driver (Windows)

1. Open the document you want to print.
2. Connect the printer to a computer using USB, Bluetooth, Wired LAN, or Wi-Fi.
3. Load paper.
4. Select the print command in your application.
5. Select your printer, and then click the printing properties or preferences button.
The printer driver window appears.
6. Change the printer driver settings, if needed.
7. Click **OK**.
8. Complete your print operation.



- If the paper is skewed after the printer pulls it into the starting position, open the Release Cover completely, remove the paper, and then close the cover and load the paper again.
- To print a JPEG image without using the printer driver, see *Related Topics: Notes on Printing Images without Using the Printer Driver*.

Making Prints Lighter or Darker

You can make prints lighter or darker by adjusting the print density setting in the printer driver's dialog box, or in the Printer Setting Tool.

For more information, see *Related Topics: Change Printer Settings Using the Printer Setting Tool (Windows)*.



Related Information

- [Create and Print Labels Using Your Computer](#)

Related Topics:

- [Notes on Printing Images without Using the Printer Driver](#)
- [Change Printer Settings Using the Printer Setting Tool \(Windows\)](#)

Print Labels Using Mobile Devices

- [Compatible Printing Apps](#)
- [AirPrint Overview](#)
- [Transfer Templates Created on a Computer to the Printer Using a Mobile Device](#)

Compatible Printing Apps

Brother offers various applications for use with your printer, including applications to print directly from your iPhone, iPad, iPod touch, and Android™ mobile devices, and applications to transfer data wirelessly, such as templates, symbols, and databases created using a computer, to your printer.

Download these free Brother apps from Google Play™ or App Store:

iOS Devices

Software	Features
Print SDK	Download the Software Development Kit (SDK) from the Brother Developer Center (https://support.brother.com/g/s/es/dev/en/index.html).
Mobile Transfer Express	This app allows you to use a mobile device to download databases and layouts, created on a computer using P-touch Editor and saved to a cloud service, and send them to your printer. Download this Brother app from the App Store.
AirPrint	AirPrint allows you to print from an Apple device (iPad, iPhone, or iPod touch) without installing additional software.
Mobile Deploy	Use this software to perform updates for the settings and firmware of printers using a mobile device. This software will send printer update files uploaded to Google Drive, OneDrive, DropBox, or an HTTP(S) server to target printers. Download this Brother app from the App Store.
Smooth Print	Use this app to print labels or receipts from iOS mobile devices to Brother printers. Smooth Print works from a user's own web app or mobile app via a URL scheme.

Android Devices

Software	Features
Print SDK	Download the Software Development Kit (SDK) from Brother Developer Center (https://support.brother.com/g/s/es/dev/en/index.html).
Mobile Transfer Express	This application allows you to use a mobile device to download databases and layouts, which were created on a computer using P-touch Editor and saved to a cloud service, and send them to your printer. Download this Brother app from Google Play.
Print Service Plugin	Allows you to print from an Android device. To use custom media, save the media information file (BIN file) in the following folder: Android/data/com.brother.printservice/files/Documents
Mobile Deploy	Allows you to perform updates for the settings and firmware of printers using a mobile device. This software will send printer update files uploaded to Google Drive, OneDrive, DropBox, or an HTTP(S) server to target printers. Download this Brother app from Google Play.
Smooth Print	Smooth Print is an app for printing labels or receipts from Android mobile devices to Brother printers. It works from a user's own web app or mobile app via a URL scheme.



Related Information

- [Print Labels Using Mobile Devices](#)

AirPrint Overview

AirPrint is a printing solution for Apple operating systems that allows you to wirelessly print photos, email, web pages and documents from your iPad, iPhone and iPod touch without the need to install a driver.



For more information, visit Apple's website.

Use of the Works with Apple badge means that an accessory has been designed to work specifically with the technology identified in the badge and has been certified by the developer to meet Apple performance standards.



Related Information

- [Print Labels Using Mobile Devices](#)

Transfer Templates Created on a Computer to the Printer Using a Mobile Device

Make sure Mobile Transfer Express is installed on your mobile device.

Use P-touch Editor to create template data in either BLF or PDZ format and save. Use Mobile Transfer Express to send the saved file from your mobile device to the printer and print it.

1. Create and save the template data using P-touch Editor.
 - a. Click **File > Transfer Template**, and then select **Export**. Save the file in either BLF or PDZ format.



For more information, see [Related Information](#).

2. Do one of the following:
 - Save the file using a cloud storage service, and then use the sharing function of the mobile device to share the file.
 - Send the file as an email attachment from the computer to the mobile device, and then save the file to the mobile device.
3. Connect the printer to your mobile device, and then start Mobile Transfer Express.
The template data appears.
4. Select the template you want to print, and then transfer the template to the printer.



To download a file from a cloud storage service to your mobile device, you must connect your mobile device using Infrastructure Mode. By connecting your mobile device to the printer using Infrastructure Mode, you can also quickly transfer downloaded files (BLF files only).



Related Information

- [Print Labels Using Mobile Devices](#)

Related Topics:

- [Create Transfer Files and Transfer Package Files \(Windows\)](#)

Standalone Printing

Related Models: TD-2350D/TD-2350DF/TD-2320DSA/TD-2350DSA

- [Create and Print Labels Using P-touch Editor \(Windows\)](#)
- [Transfer a Template or Other Data from the Computer to the Printer \(Windows\)](#)
- [Transfer Multiple Items from the Computer to the Printer \(Windows\)](#)
- [Transfer the Label Layout to the Printer](#)
- [Call Up the Transferred Template on the Printer's LCD and Print](#)
- [Change the Screen Display in Template Touch Mode](#)

Create and Print Labels Using P-touch Editor (Windows)

To use your printer with your Windows computer, install your model's printer driver and P-touch Editor on your computer.

For the latest drivers and software, go to your model's **Downloads** page at support.brother.com/downloads.

1. Start P-touch Editor .

Click **Start > Brother P-touch > P-touch Editor**, or double-click the **P-touch Editor** icon on the desktop.

NOTE

Depending on your computer's operating system, the Brother P-touch folder may or may not be created.

2. Make sure your model's name is selected on the Home screen.
3. Do one of the following:
 - To create a new layout, click the **New Label** tab, and then click the **New Label** button (1).
 - To create a new layout using a preset layout, click the **New Label** tab, and then click a category button (2), select a template, and then click **Create** (3).
 - To open an existing layout, click **Open** (4).

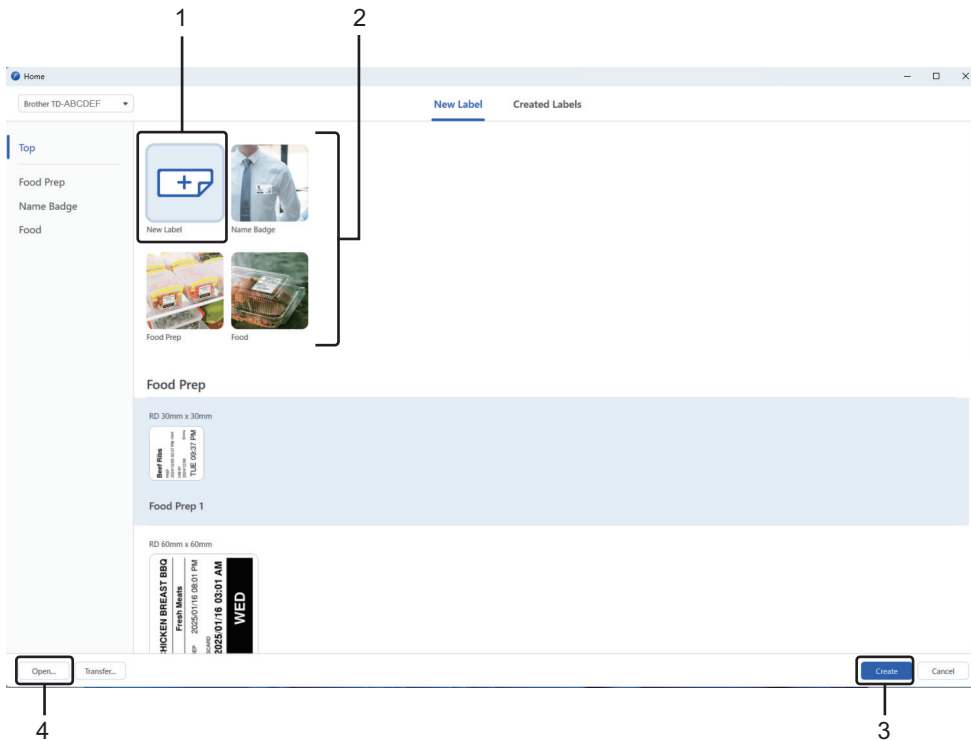

4. Click the **Print** icon.
5. Select the print settings you want, and then click **Print**.



To change how P-touch Editor starts, open P-touch Editor and click **File > Options**. Select the **Mode** option on the left side of the screen, and then select the **Home/Office** or **Electrical/Network** option. Click **OK** to apply the setting.



Related Information

- [Standalone Printing](#)

Transfer a Template or Other Data from the Computer to the Printer (Windows)

1. Connect the printer to the computer using a USB cable, and then turn the printer on.
2. Start P-touch Editor .

Click **Start > Brother P-touch > P-touch Editor**, or double-click the **P-touch Editor** icon on the desktop.

NOTE

Depending on your computer's operating system, the Brother P-touch folder may or may not be created.

3. Make sure your model's name is selected on the Home screen.
4. Open the template you want or create a new layout.
5. Click **File > Transfer Template**.

The Transfer window appears. The template or other data is listed in the window under **Transfer Name** .

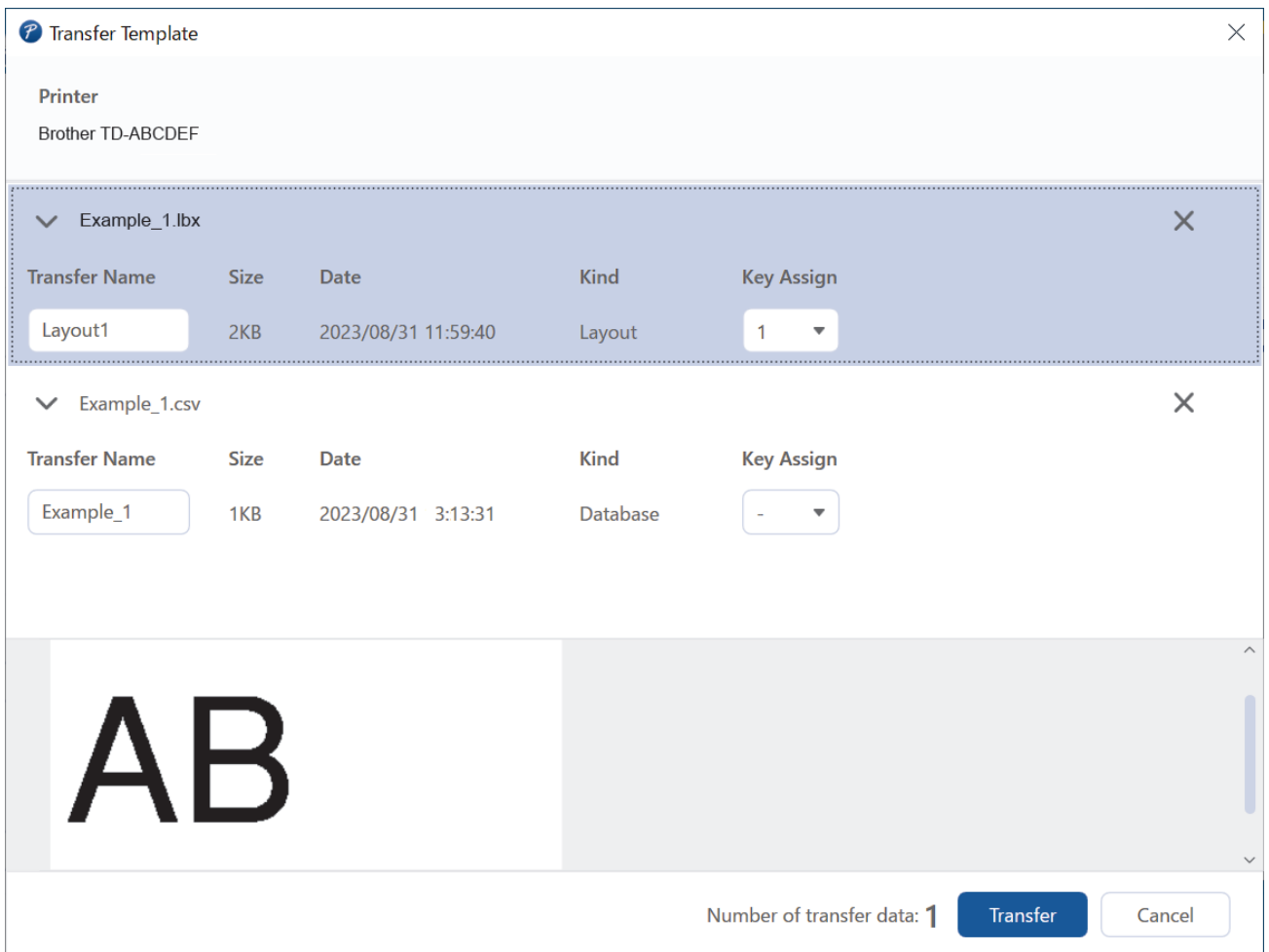

Transfer Name	Size	Date	Kind	Key Assign
Layout1	2KB	2023/08/31 11:59:40	Layout	1

Transfer Name	Size	Date	Kind	Key Assign
Example_1	1KB	2023/08/31 3:13:31	Database	-

6. To change the **Key Assign** number, that is, the file location in the printer, assigned to a template, click the template file you want, and then select the **Key Assign** number.



Use Key Assign numbers to search for template files on your printer.

NOTE

- The database is not assigned a Key Assign number.

-
- The printer will overwrite any previously saved template that has the same Key Assign number as a new template being transferred to it.

7. To change the transfer name of the template or other data, click the item you want, and then type the new name.

The number of characters allowed for the file name differs depending on the printer model.

8. From the file list, select the template or other data you want to transfer, and then click **Transfer**.

9. Click **OK**.

The selected items are transferred to the printer.



You can transfer multiple templates or other data at the same time. For more information, see *Related Topics: Transfer Multiple Items from the Computer to the Printer (Windows)*.



Related Information

- [Standalone Printing](#)
- [Print Labels Using Barcode Scanner or Other Devices \(P-touch Template\)](#)
- [Transfer Templates to the Printer Using Your Computer \(Windows\)](#)

Related Topics:

- [Transfer Templates Created on a Computer to the Printer Using a Mobile Device](#)
 - [Confirm Printer Settings](#)
 - [Transfer Multiple Items from the Computer to the Printer \(Windows\)](#)
-

Transfer Multiple Items from the Computer to the Printer (Windows)

When you transfer multiple items using P-touch Editor, follow these guidelines.

Data Type	Maximum Number of Transferable Items	Restriction Details
Template	255	Each template can contain up to 255 objects (text and barcodes).
Database	255	<ul style="list-style-type: none">• Only CSV files can be transferred.• Each CSV file can contain a maximum of 100 columns and 65000 records.
Image (transferred symbols)	255	<ul style="list-style-type: none">• Only *.bmp files can be transferred.• Monochrome *.bmp files are recommended.• The size limit is 1296 x 1296 pixels.• Wide images may be cropped.

The user ROM storage capacity is 8 MB for TD-2310D and 32 MB for other models.

1. Connect the printer to the computer using a USB cable, and then turn the printer on.
2. Start P-touch Editor .

Click **Start > Brother P-touch > P-touch Editor**, or double-click the **P-touch Editor** icon on the desktop.

NOTE

Depending on your computer's operating system, the Brother P-touch folder may or may not be created.

3. Make sure your model's name is selected on the Home screen, and then click **Transfer**.
4. In the **Transfer** window, click **Browse** and specify the items you want to transfer.
The specified items appear in the file list.
5. Make sure the items you want to transfer are selected in the file list, and then click **Transfer**.
6. Click **OK**.

The selected items are transferred to the printer.

Related Information

- [Standalone Printing](#)
- [Print Labels Using Barcode Scanner or Other Devices \(P-touch Template\)](#)
- [Transfer Templates to the Printer Using Your Computer \(Windows\)](#)

Related Topics:

- [Transfer a Template or Other Data from the Computer to the Printer \(Windows\)](#)

Transfer the Label Layout to the Printer

Related Models: TD-2320DSA/TD-2350DSA

Transfer a label created on your computer to your printer if you want to use the printer's LCD to print as many labels as required.

Use P-touch Editor to transfer data to the printer. For more information, see *Related Topics: Transfer a Template or Other Data from the Computer to the Printer (Windows)*.



Before transferring data, make sure printer's LCD displays the Home screen (either the Template List Screen or the Template Touch Screen).

When templates are transferred to the printer, the transferred templates appear on the LCD as shown in the illustration. This display order corresponds to the P-touch Transfer Manager's Key Assign number, and absent Key Assign numbers are displayed as blanks on the LCD.



- You can transfer up to 255 templates to your printer.
- If a new template is transferred with the same Key Assign number as another template already on the printer, the new template will overwrite the old one.



Related Information

- [Standalone Printing](#)

Related Topics:

- [Transfer a Template or Other Data from the Computer to the Printer \(Windows\)](#)

Call Up the Transferred Template on the Printer's LCD and Print

Related Models: TD-2350D/TD-2350DF/TD-2320DSA/TD-2350DSA

You can print transferred or preset templates from the printer's LCD, without connecting the printer to a computer or a mobile device.

- [Print a Template That is Not Linked to a Database](#)
- [Print a Template Linked to a Database](#)
- [Use the Search Function to Find a Template or Database in Template List Mode](#)
- [Edit Template Objects Before Printing](#)

Print a Template That is Not Linked to a Database

Related Models: TD-2350D/TD-2350DF/TD-2320DSA/TD-2350DSA

>> TD-2350D/TD-2350DF

>> TD-2320DSA/TD-2350DSA

TD-2350D/TD-2350DF

1. Make sure the LCD is in the Template List Screen as shown below.



If it is not, set it to the Template List Screen.

- a. Press **Menu**.
 - b. Press **▲** or **▼** to select [Settings]. Press **OK**.
 - c. Press **▲** or **▼** to select [Home Screen]. Press **OK**.
 - d. Press **▲** or **▼** to select [Template List Screen]. Press **OK**.
2. Press **▲** or **▼** to select a template, and then press **OK**.
 3. Press **▲** and **▼** to set the number of labels you want to print.



NOTE

- To change print number of labels for future use, press **Menu** and go to [Template Settings] and set the [Confirm Print] option to [On].
The next time you print using this template, the print settings screen appears, allowing you to change the number of labels using **▲** and **▼**.
- To display a print preview, press **Menu** twice, and then press **OK**.
- To display the object in the template, press **Menu** once, and then press **OK**.

TD-2320DSA/TD-2350DSA

1. If the LCD is not in Template List Screen or in Template Touch Screen, as shown, follow the steps below:



The number of characters on the screen can differ depending on the screen type.

Template List Screen



The maximum length of the template name is 15 characters, not including the Key Assign number.

Template Touch Screen



The maximum length of the template name depends on the screen format you select.

For more information, see *Related Topics: Change the Screen Display in Template Touch Mode*.

- a. Press **Menu**.
 - b. Press **▲** or **▼** to select [Settings]. Press **OK**.
 - c. Press **▲** or **▼** to select [Home Screen]. Press **OK**.
 - d. Press **▲** or **▼** to select [Template List Screen] or [Template Touch Screen]. Press **OK**.
2. Press **▲** or **▼** to select a template, and then press **OK**.



The search function helps you select the template and the database. For more information, see *Related Topics: Use the Search Function to Find a Template or Database in Template List Mode*.

3. Press **▲** and **▼** to set the number of labels you want to print.

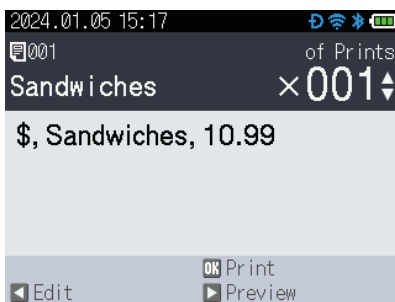

NOTE

- To change print number of labels for future use, press **Menu** and go to [Template Settings] and set the [Confirm Print] option to [On].

The next time you print using this template, the print settings screen appears, allowing you to change the number of labels using **▲** and **▼**.

- To display a print preview, press **▶**.

4. To display and edit the objects in the template, press **◀**.
5. Use the **▲**, **▼**, and **OK** to select an object.
6. Touch the on-screen button or press the printer's numerical keys to edit the object, and then press **OK**.

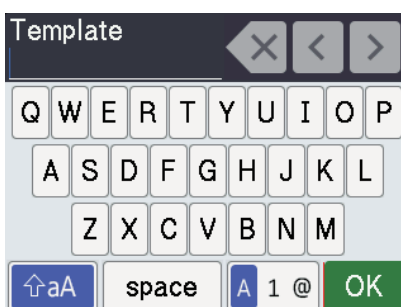

-
7. When you have finished editing the objects you want to change, press  to return to the Print Settings Screen.



Related Information

- [Call Up the Transferred Template on the Printer's LCD and Print](#)

Related Topics:

- [Use the Search Function to Find a Template or Database in Template List Mode](#)
 - [Change the Screen Display in Template Touch Mode](#)
-

Print a Template Linked to a Database

Related Models: TD-2350D/TD-2350DF/TD-2320DSA/TD-2350DSA

>> TD-2350D/TD-2350DF

>> TD-2320DSA/TD-2350DSA

TD-2350D/TD-2350DF

1. Make sure the LCD is in the Template List Screen as shown below.



If it is not, set it to the Template List Screen.

- a. Press **Menu**.
 - b. Press **▲** or **▼** to select [Settings]. Press **OK**.
 - c. Press **▲** or **▼** to select [Home Screen]. Press **OK**.
 - d. Press **▲** or **▼** to select [Template List Screen]. Press **OK**.
2. Press **▲** or **▼** to select a template, and then press **OK**.
 3. Press **▲** or **▼** to select the database record, and then press **OK**.
 4. Press **▲** and **▼** to set the number of labels you want to print.

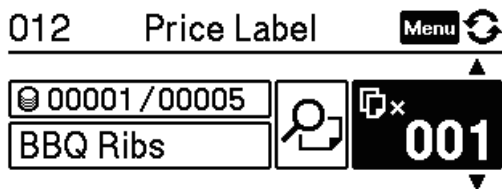

NOTE

- To change print number of labels for future use, press **Menu** and go to [Template Settings] and set the [Confirm Print] option to [On].
The next time you print using this template, the print settings screen appears, allowing you to change the number of labels using **▲** and **▼**.
- To display a print preview, press **Menu** twice, and then press **OK**.
- To display the object in the template, press **Menu** once, and then press **OK**.

TD-2320DSA/TD-2350DSA

1. If the LCD is not in Template List Screen or in Template Touch Screen, as shown, follow the steps below:

Template List Screen



Template Touch Screen



- a. Press **Menu**.
 - b. Press **▲** or **▼** to select [Settings]. Press **OK**.
 - c. Press **▲** or **▼** to select [Home Screen]. Press **OK**.
 - d. Press **▲** or **▼** to select [Template List Screen] or [Template Touch Screen]. Press **OK**.
2. Press **▲** or **▼** to select a template, and then press **OK**.



The search function helps you select the template and the database. For more information, see *Related Topics: Use the Search Function to Find a Template or Database in Template List Mode*.

3. Press **▲** or **▼** to select the database record, and then press **OK**.



The search function helps you select the template and the database. For more information, see *Related Topics: Use the Search Function to Find a Template or Database in Template List Mode*.

4. Press **▲** and **▼** to set the number of labels you want to print.

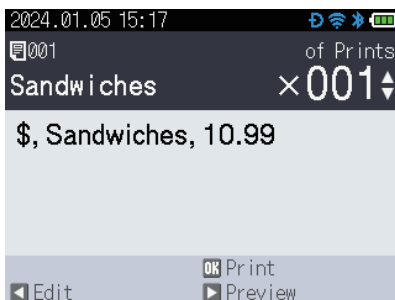

NOTE

- To change print number of labels for future use, press **Menu** and go to [Template Settings] and set the [Confirm Print] option to [On].

The next time you print using this template, the print settings screen appears, allowing you to change the number of labels using **▲** and **▼**.

- To display a print preview, press **▶**.

5. To display and edit the objects in the template, press **◀**.
6. Press **▲**, **▼**, and **OK** to select an object.
7. Touch the on-screen button or press the printer's numerical keys to edit the object, and then press **OK**.

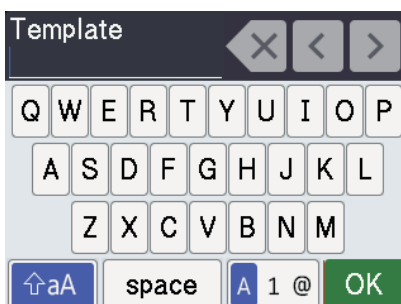

-
8. When you have finished selecting and editing the required objects, press  to return to the print settings screen.

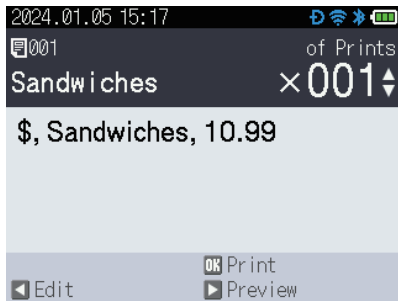

Related Information

- [Call Up the Transferred Template on the Printer's LCD and Print](#)

Related Topics:

- [Use the Search Function to Find a Template or Database in Template List Mode](#)
-

Use the Search Function to Find a Template or Database in Template List Mode

Related Models: TD-2320DSA/TD-2350DSA

Create a database that contains the search number in column A and the item name in column B.

In addition to using the ▲ and ▼ keys to search for templates and databases on the Template List Screen, you can also use the printer's search function.

There are two search methods:

- Numerical search:
 - When searching for a template, it looks for any template with your search numbers in its template number. The template number is the Key Assign number that is set when transferring labels from P-touch Editor.
 - When searching a database, it looks for a row where column A contains the number you entered.
- Product name search:
 - When searching for a template, it looks for any template with your search characters in its name and displays the corresponding templates.
 - When searching a database, it looks for rows where column B contains the characters you entered and displays the corresponding rows.

Set the search method in advance in [Search Settings] under [Template Settings].

1. With templates or databases displayed in a list, press any key on the numerical keypad to enter search mode.
2. Touch the on-screen button to enter the text you want to search. Press **OK**.
3. When the search results appear, press ▲ or ▼ to select desired item. Press **OK**.
The required template or database is now detected and selected.

✓ Related Information

- [Call Up the Transferred Template on the Printer's LCD and Print](#)

Edit Template Objects Before Printing

Related Models: TD-2320DSA/TD-2350DSA

After you select a template or a template and database, you can edit the objects contained in the template.

1. After selecting a template or selecting a template and database, press ◀ on the copy number entry screen to enter Object edit mode.



2. Press ▲ or ▼ to select the object. Press **OK**.



3. When the search results appear, press ▲ or ▼ to select desired item. Press **OK**.
4. Touch the on-screen button to edit the object, and then press **OK**.

✓ Related Information

- [Call Up the Transferred Template on the Printer's LCD and Print](#)

Change the Screen Display in Template Touch Mode

Related Models: TD-2320DSA/TD-2350DSA

Change the number of templates and databases displayed

The display styles in Template Touch Screen include 4x3, 4x2, 4x1, and 2x2.

Select your display style from the [Touch Mode Setting] in the [Template Settings] menu.

The printer's Numerical / Letter buttons correspond to each entry on the screen as shown in the illustrations below.

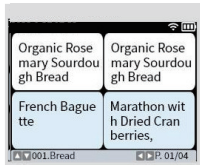

12 characters x 3 lines

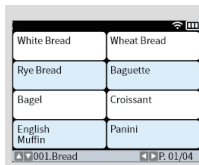

18 characters x 2 lines

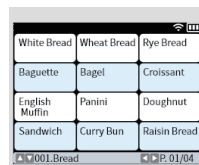

12 characters x 2 lines

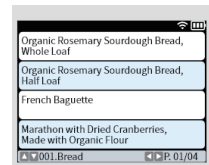

38 characters x 2 lines



Change the Columns of the Database Table to be Displayed on the Screen.

If you select one database table while viewing databases, the contents of the columns in the selected database table will be displayed. Database tables typically have multiple columns, and you can press the  (Space) button to change which column is displayed.

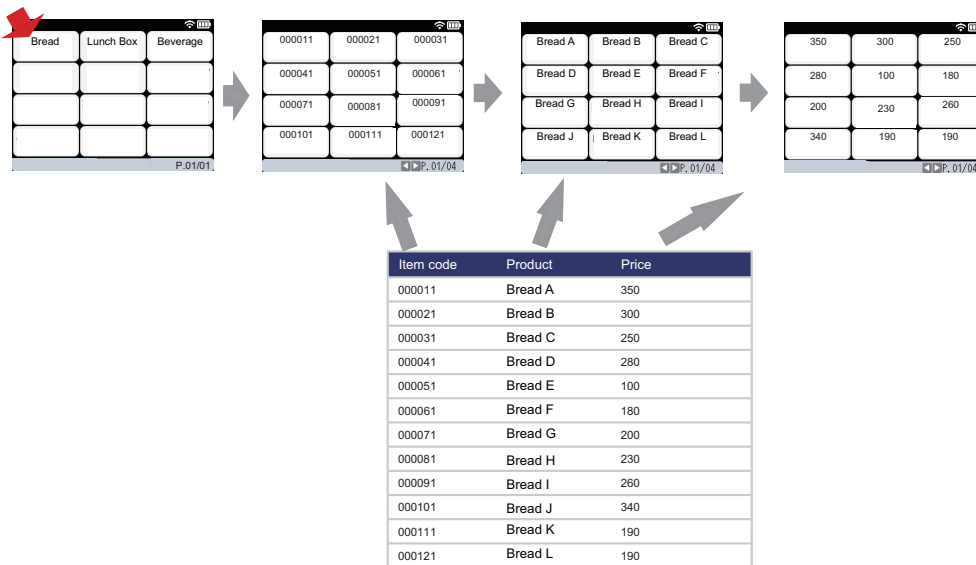

✓ Related Information

- [Standalone Printing](#)

Related Topics:

- [Print a Template That is Not Linked to a Database](#)

Print Labels Using Barcode Scanner or Other Devices (P-touch Template)

- [P-touch Template Operations Overview](#)
- [Create and Print Labels Using P-touch Editor \(Windows\)](#)
- [Transfer a Template or Other Data from the Computer to the Printer \(Windows\)](#)
- [Transfer Multiple Items from the Computer to the Printer \(Windows\)](#)
- [Specify the Barcode Scanner Settings \(Windows\)](#)
- [Connect the Printer to a Barcode Scanner Using Bluetooth](#)
- [Connect the Printer to a Barcode Scanner Using USB Host Interface](#)
- [Try the P-touch Template Function Using the Barcode List](#)

P-touch Template Operations Overview

P-touch Template Mode allows you to insert data into text and barcode objects on templates transferred to the printer using other devices connected to the printer.

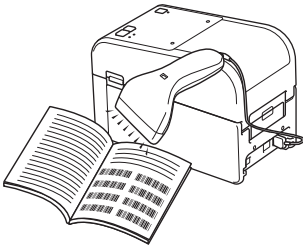

- P-touch Template Mode is also compatible with other input devices like scales, testing machines, controllers, or a programmable logic devices.
- For more information, see the *P-touch Template Manual/Command Reference* (English only). You can download the latest version from the Brother support website at support.brother.com/manuals.

Basic Operations

Recall Printing

Transfer frequently used templates and images to the printer in advance. Prepare a barcode containing numbers for template selection and information to start printing. Read the barcode with a barcode scanner connected to the printer to select the template and start printing.

Merge Printing

Download a template and scan a barcode to print a copy or to insert the scanned data into a different template.

Database Lookup Printing

Download a database linked to a template and scan a barcode to find a record to insert into the template and print.

See *Related Information*.

Advanced Operations

Numbered (Serialised Number) Printing

Increment printed text or barcodes in any downloaded template.

See *Related Information*.



Related Information

- [Print Labels Using Barcode Scanner or Other Devices \(P-touch Template\)](#)

Related Topics:

- [Recall and Print the Template Transferred to the Printer \(Recall Printing\)](#)
- [Insert Information into a Template Transferred to the Printer and Print It \(Merge Printing\)](#)
- [Print the Template Linked to the Database \(Database Lookup Printing\)](#)
- [Print Transferred Templates in Serialised \(Numerical\) Order \(Numbered \(Serialised Number\) Printing\)](#)

Create and Print Labels Using P-touch Editor (Windows)

To use your printer with your Windows computer, install your model's printer driver and P-touch Editor on your computer.

For the latest drivers and software, go to your model's **Downloads** page at support.brother.com/downloads.

1. Start P-touch Editor .

Click **Start > Brother P-touch > P-touch Editor**, or double-click the **P-touch Editor** icon on the desktop.

NOTE

Depending on your computer's operating system, the Brother P-touch folder may or may not be created.

2. Make sure your model's name is selected on the Home screen.
3. Do one of the following:
 - To create a new layout, click the **New Label** tab, and then click the **New Label** button (1).
 - To create a new layout using a preset layout, click the **New Label** tab, and then click a category button (2), select a template, and then click **Create** (3).
 - To open an existing layout, click **Open** (4).

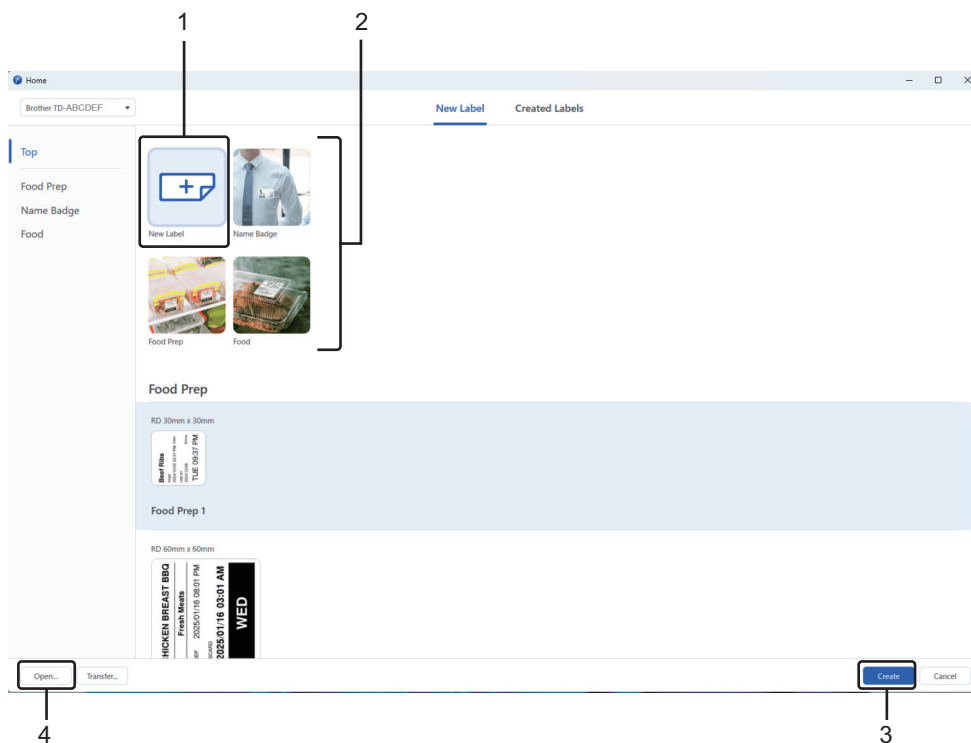

4. Click the **Print** icon.
5. Select the print settings you want, and then click **Print**.



To change how P-touch Editor starts, open P-touch Editor and click **File > Options**. Select the **Mode** option on the left side of the screen, and then select the **Home/Office** or **Electrical/Network** option. Click **OK** to apply the setting.



Related Information

- [Print Labels Using Barcode Scanner or Other Devices \(P-touch Template\)](#)

Transfer a Template or Other Data from the Computer to the Printer (Windows)

1. Connect the printer to the computer using a USB cable, and then turn the printer on.
2. Start P-touch Editor .

Click **Start > Brother P-touch > P-touch Editor**, or double-click the **P-touch Editor** icon on the desktop.

NOTE

Depending on your computer's operating system, the Brother P-touch folder may or may not be created.

3. Make sure your model's name is selected on the Home screen.
4. Open the template you want or create a new layout.
5. Click **File > Transfer Template**.

The Transfer window appears. The template or other data is listed in the window under **Transfer Name** .

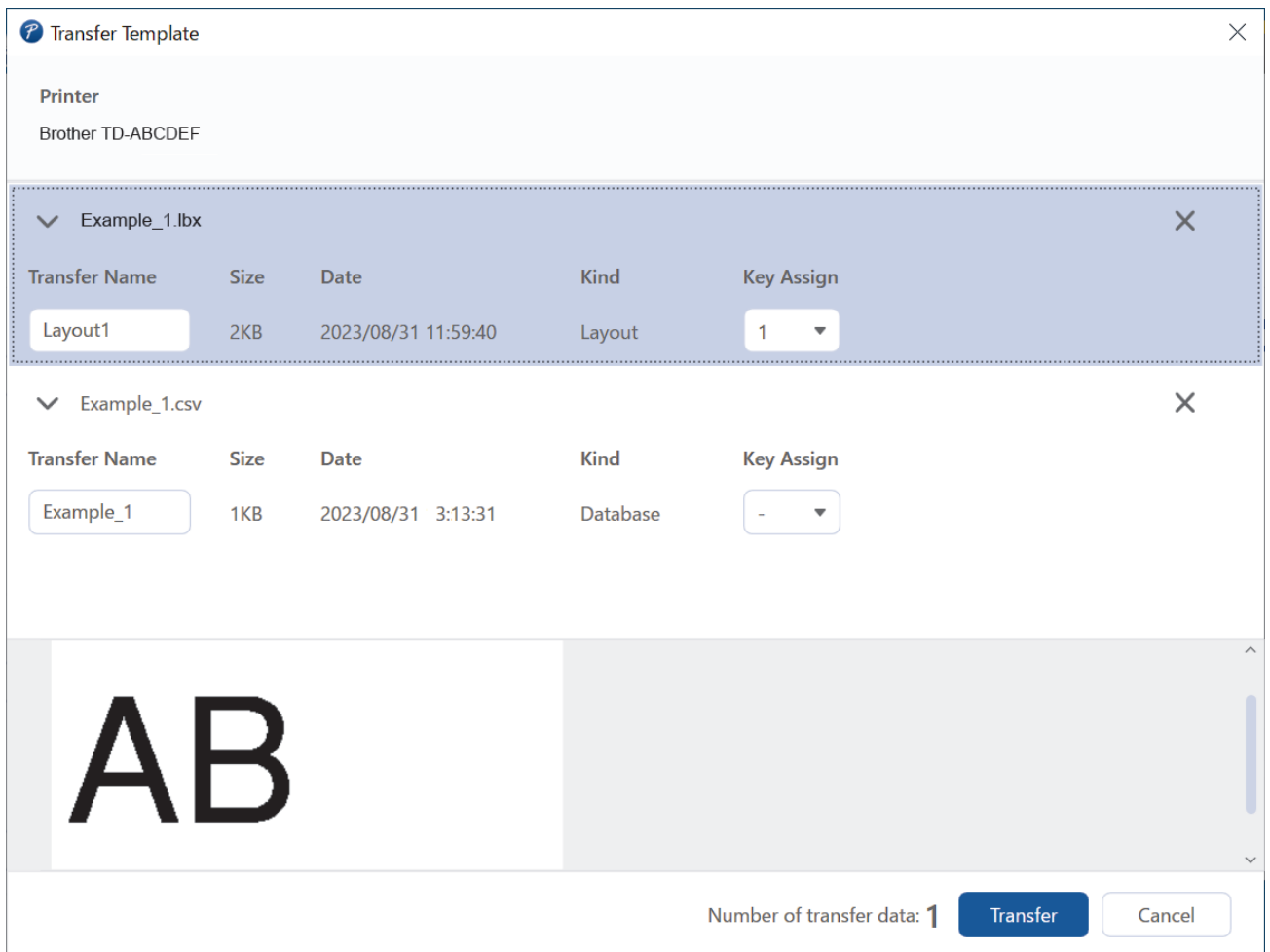

6. To change the **Key Assign** number, that is, the file location in the printer, assigned to a template, click the template file you want, and then select the **Key Assign** number.



Use Key Assign numbers to search for template files on your printer.

NOTE

- The database is not assigned a Key Assign number.

-
- The printer will overwrite any previously saved template that has the same Key Assign number as a new template being transferred to it.

7. To change the transfer name of the template or other data, click the item you want, and then type the new name.

The number of characters allowed for the file name differs depending on the printer model.

8. From the file list, select the template or other data you want to transfer, and then click **Transfer**.

9. Click **OK**.

The selected items are transferred to the printer.



You can transfer multiple templates or other data at the same time. For more information, see *Related Topics: Transfer Multiple Items from the Computer to the Printer (Windows)*.



Related Information

- [Standalone Printing](#)
- [Print Labels Using Barcode Scanner or Other Devices \(P-touch Template\)](#)
- [Transfer Templates to the Printer Using Your Computer \(Windows\)](#)

Related Topics:

- [Transfer Templates Created on a Computer to the Printer Using a Mobile Device](#)
 - [Confirm Printer Settings](#)
 - [Transfer Multiple Items from the Computer to the Printer \(Windows\)](#)
-

Transfer Multiple Items from the Computer to the Printer (Windows)

When you transfer multiple items using P-touch Editor, follow these guidelines.

Data Type	Maximum Number of Transferable Items	Restriction Details
Template	255	Each template can contain up to 255 objects (text and barcodes).
Database	255	<ul style="list-style-type: none">• Only CSV files can be transferred.• Each CSV file can contain a maximum of 100 columns and 65000 records.
Image (transferred symbols)	255	<ul style="list-style-type: none">• Only *.bmp files can be transferred.• Monochrome *.bmp files are recommended.• The size limit is 1296 x 1296 pixels.• Wide images may be cropped.

The user ROM storage capacity is 8 MB for TD-2310D and 32 MB for other models.

1. Connect the printer to the computer using a USB cable, and then turn the printer on.
2. Start P-touch Editor .

Click **Start > Brother P-touch > P-touch Editor**, or double-click the **P-touch Editor** icon on the desktop.

NOTE

Depending on your computer's operating system, the Brother P-touch folder may or may not be created.

3. Make sure your model's name is selected on the Home screen, and then click **Transfer**.
4. In the **Transfer** window, click **Browse** and specify the items you want to transfer.
The specified items appear in the file list.
5. Make sure the items you want to transfer are selected in the file list, and then click **Transfer**.
6. Click **OK**.
The selected items are transferred to the printer.

Related Information

- [Standalone Printing](#)
- [Print Labels Using Barcode Scanner or Other Devices \(P-touch Template\)](#)
- [Transfer Templates to the Printer Using Your Computer \(Windows\)](#)

Related Topics:

- [Transfer a Template or Other Data from the Computer to the Printer \(Windows\)](#)

Specify the Barcode Scanner Settings (Windows)

Before connecting the barcode scanner to the printer, specify the barcode scanner settings using the P-touch Template Settings (in the Printer Setting Tool).



To include multiple object data on a label, search the database and print, or print immediately after reading a barcode, you must adjust P-touch Template settings. By customizing barcode scanner settings, you can attach a command to the string read by the scanner that the barcode scanner sends to the printer.

- To put multiple object data on a label, or if you want to search the database and print: Enter "\09" in the **Data Delimiter for P-touch Template:** field.
- To print immediately after reading a barcode: Enter "^FF" in the **Trigger for P-touch Template Printing** field as **Command Character**.

1. Connect the printer and the computer via a USB cable, and then turn the printer on.
2. Start the Printer Setting Tool.
Click **Start > Brother > Printer Setting Tool**.
3. Click the **P-touch Template Settings** button.
4. Select the settings you want, and then click **Set**.



- By default, printing begins when the code "^FF" is scanned from a barcode using a barcode scanner. (This can be changed with the settings highlighted by (A) in the previous image.)
If the **Received Data Size** option is selected with the number of bytes setting, the template is printed after the specified number of bytes have been scanned.
- Because the print mode setting returns to raster mode each time you print from the computer, you must change the setting to template mode again.
- If you turn the printer off and then turn it on again, the printer starts up in template mode.



Related Information

- [Print Labels Using Barcode Scanner or Other Devices \(P-touch Template\)](#)
-

Connect the Printer to a Barcode Scanner Using Bluetooth

Related Models: TD-2350D/TD-2350DF/TD-2350DSA

We recommend using a reliable high-quality barcode scanner and checking the barcode scanner specifications before selecting a model.

We recommend using models that support Serial Port Profile (SPP) when scanning via Bluetooth.





- For P-touch Template mode, templates must first be downloaded from a computer to the printer using P-touch Editor.
- Contact the manufacturer for more information on how to use and program a specific barcode scanner model.
- Follow the recommendations of the manufacturer of your Bluetooth-equipped devices, such as barcode scanners, and install any necessary hardware and software.
- The Bluetooth connection settings are saved even after the printer is turned off.

1. Press **Menu**.
2. Press **▲** or **▼** to select the following:
 - a. Select [Bluetooth]. Press **OK**.
 - b. Select [Bluetooth (On/Off)]. Press **OK**.
3. Press **▲** or **▼** to select [On]. Press **OK**.

 appears on the LCD.



TD-2350DSA: Depending on your model,  may appear instead of .

4. Pair the printer with the barcode scanner via Bluetooth.

Press **Menu**, and then [Bluetooth] > [Print Barcode] to print the Bluetooth address for connecting to a Bluetooth barcode scanner.

If the printer's PIN is required: the default PIN is the last four digits of the product serial number. The serial number is located on the bottom or inside the printer. You can change the PIN in the Printer Setting Tool.

- During pairing, the Bluetooth passkey may appear on the screen. If you selected the **Pairing requires user confirmation on printer** checkbox in the Bluetooth tab of the Communication Settings dialog box, press **OK** on the printer.
- Depending on the specifications of the barcode scanner, the pairing may not be successful if the setting requires key operation of the printer during pairing. In this case, deselect the **Pairing requires user confirmation on printer** checkbox in the Bluetooth tab of the Communication Settings dialog box.

When a connection has been established, the printer remains connected until it is turned off, preventing it from connecting to another device.



Related Information

- [Print Labels Using Barcode Scanner or Other Devices \(P-touch Template\)](#)

Connect the Printer to a Barcode Scanner Using USB Host Interface

Related Models: TD-2320D/TD-2350D/TD-2320DF/TD-2350DF/TD-2320DSA/TD-2350DSA

We recommend using a reliable high-quality barcode scanner and checking the barcode scanner specifications before selecting a model.

Recommended barcode scanner selection criteria: HID-class models identified as a keyboard



- For P-touch Template mode, templates must first be downloaded from a computer to the printer using P-touch Editor.
- The barcode scanner should be programmed to use the English keyboard. For beginners, we recommend programming your barcode scanner with no prefix and no suffix characters. For advanced users, the prefix and suffix characters can be scanned and used as commands with the printer for creating customised templates.
- Contact the manufacturer for more information on how to use and program a specific barcode scanner model.

Connect a barcode scanner to the printer's USB host port.



Related Information

- [Print Labels Using Barcode Scanner or Other Devices \(P-touch Template\)](#)

Try the P-touch Template Function Using the Barcode List

- [Recall and Print the Template Transferred to the Printer \(Recall Printing\)](#)
- [Insert Information into a Template Transferred to the Printer and Print It \(Merge Printing\)](#)
- [Print the Template Linked to the Database \(Database Lookup Printing\)](#)
- [Print Transferred Templates in Serialised \(Numerical\) Order \(Numbered \(Serialised Number\) Printing\)](#)
- [Barcodes Used for Specifying Settings](#)

Recall and Print the Template Transferred to the Printer (Recall Printing)

Transfer frequently used templates and images to the printer in advance. Prepare a barcode containing numbers for template selection and information to start printing. Read the barcode with a barcode scanner connected to the printer to select the template and start printing.

Example:



- For more information on the barcodes scanned using various settings, see *Related Information*.
- Grouped objects are converted and sent as an image.
- The following these barcodes may not be available depending on the model.

1. Use P-touch Editor to transfer a template or label layout from the computer to the printer.

For more detailed information, see *Related Information*.

2. Scan the following barcode:

P-touch template command (initialise + begin specifying settings)



Esc|a3^II

3. From the following barcode list, scan each barcode to send a command or setting to the printer:

Basic settings

Auto cut on (Cut every one label) + Cut at end on ^c01011	Auto cut on (Cut every two labels) + Cut at end on ^c01021
Auto cut off + Cut at end on ^c00001	Auto cut off + Cut at end off ^c00000



- Settings can be made with multiple commands.
- If no settings have been made by scanning the barcode commands, a template is printed using the P-touch Template settings. The default P-touch Template settings are to print a single copy with Auto Cut turned on.

For more information on P-touch Template Settings, see the *P-touch Template Manual/Command Reference* (English only). You can download the latest version from the Brother support website at support.brother.com/manuals.

4. Specify the number of copies you want.

- a. Scan the following barcode:

Number of copies













^CN

- b. Scan the following barcodes to specify a three-digit number:

Example:

Specify numbers by scanning the following barcodes: when printing 7 sheets; [0][0][7], when printing 15 sheets; [0][1][5]

For entering numbers









1  1	2  2
3  3	4  4
5  5	6  6
7  7	8  8
9  9	0  0
00  00	



To change the setting for the number of copies, repeat these steps.

- Scan one of the following barcodes with the same number as the Key Assign number for the label layout you want:

Preset template number

Preset template 1  ^TS001^FF	Preset template 2  ^TS002^FF
Preset template 3  ^TS003^FF	Preset template 4  ^TS004^FF
Preset template 5  ^TS005^FF	Preset template 6  ^TS006^FF
Preset template 7  ^TS007^FF	Preset template 8  ^TS008^FF

Preset template 9



^TS009^FF

Preset template 10



^TS010^FF

The specified label is printed.



Related Information

- [Try the P-touch Template Function Using the Barcode List](#)
 - [Lock Labels for Editing](#)

Related Topics:

- [Barcodes Used for Specifying Settings](#)
-

Lock Labels for Editing

To protect frequently used templates from unwanted edits, convert a text object in the label layout to an image. After converting the label layout to an image, the text cannot be changed.

1. When you insert a text object in the P-touch Editor Layout window, the **Expanded** tab will appear in the properties on the right.
2. Click the **More** tab, and then select the **Disable text editing** checkbox.



Related Information

- [Recall and Print the Template Transferred to the Printer \(Recall Printing\)](#)
-

Insert Information into a Template Transferred to the Printer and Print It (Merge Printing)

Transfer a template to the printer. Print the transferred template by inserting the information read from the barcode scanner connected to the printer.



- For more information on the barcodes scanned using various settings, see *Related Information*.
- If a barcode has a different protocol than the barcode template already registered with the printer, you may be unable to create or print the barcode.
- Depending on the barcode scanner model, some barcode standards and protocols may not be supported by this printer.

1. Use P-touch Editor to transfer a template or label layout from the computer to the printer.

For more detailed information, see *Related Information*.

NOTE

It is important to design a template to meet the barcode symbology or protocol requirements, especially for the label size and barcode position in the label to fit the maximum number and type of characters being inserted from the barcode scanner. A barcode in the template cannot be created or scanned if the barcode with the inserted data does not fit entirely within the label printable image area.

2. Open the template you want or create a new layout and click **File > Transfer Template**.
 - To change the Key Assign number (memory location in the printer) assigned to an item, click the item you want, and then select the number.
 - To change the transfer name of the template or other data, click the item you want, and then type the new name. The number of characters differs depending on the printer model.

NOTE

- The database is not assigned a Key Assign number.
- The printer will overwrite any previously saved template that has the same key number as a new template being transferred to it.

3. Make sure the template or other data you want to transfer is selected in the file list, and then click **Transfer** and click **OK**.
4. Scan the following barcode:

P-touch template command (initialise + begin specifying settings)



Esq]ia3^11

5. From the following barcode list, scan each barcode to send a command or setting to the printer:

Basic settings

Auto cut on (Cut every one label) + Cut at end on





^c01011

Auto cut on (Cut every two labels) + Cut at end on



^c01021

Auto cut off + Cut at end on  ^c00001	Auto cut off + Cut at end off  ^c00000
Number of copies  ^cN	



- Settings can be made with multiple commands.
- If no settings have been made by scanning the barcode commands, a template is printed using the P-touch Template settings. The default P-touch Template settings are to print a single copy with Auto Cut turned on.

For more information on P-touch Template Settings, see the *P-touch Template Manual/Command Reference* (English only). You can download the latest version from the Brother support website at support.brother.com/manuals.

6. Specify the number of copies you want.

- a. Scan the following barcode:

Number of copies











- b. Scan the following barcodes to specify a three-digit number:

Example:

Specify numbers by scanning the following barcodes: when printing 7 sheets; [0][0][7], when printing 15 sheets; [0][1][5]

For entering numbers

1 	2 
3 	4 
5 	6 
7 	8 
9 	0 

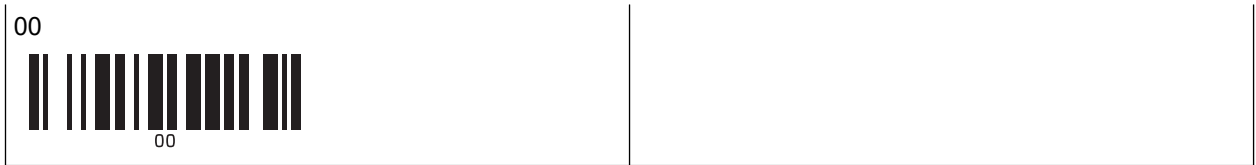

To change the setting for the number of copies, repeat these steps.

7. Scan the following barcode:

Select template



8. Scan the following barcodes with the same number (three digits) as the Key Assign number used for the downloaded template to be printed:

Example:

Specify numbers by scanning the following barcodes: when printing number 7; [0][0][7], when printing number 15; [0][1][5]

For entering numbers

1 	2
3 	4
5 	6
7 	8
9 	0
00 	

The downloaded template is selected after the three digit numbers have been scanned.



You can use P-touch Editor to create and print a label with a single barcode.

Example:



9. Scan a barcode containing the data you want inserted into the barcode object in the selected downloaded template.

Example:



10. Scan the following barcode to send the command to start printing:

Begin printing



The barcode in the printed template contains the data from the barcode scanned.

Example:



Related Information

- [Try the P-touch Template Function Using the Barcode List](#)

Related Topics:

- [Barcodes Used for Specifying Settings](#)
-

Print the Template Linked to the Database (Database Lookup Printing)

Transfers the template and the database linked to the template to the printer. By using the barcode as a keyword, it is possible to search the database for records containing the keyword and to print the template with the search result merged into it.



- For more information on the barcodes scanned using various settings, see *Related Information*.
- The printer has reserved the leftmost column (A) of a downloaded linked database for this operation, therefore the keyword scanned from a barcode must be in this column of the database.
- For the printer to find keywords successfully, the data in the leftmost column (A) must exactly match the keywords scanned from a barcode.
- P-touch Editor and the printer can read only one line of data in each field of a linked database so we do not recommend using databases with two or more lines of data in the leftmost column (A).

1. Use P-touch Editor to create a template and connect to a database file.



- You can link as many columns to a text and barcode objects in the template as needed.
- Make sure the keywords are included in the leftmost column (A) but do not link any text or barcode object in the template with field (A) if you do not need the data on the printed label.



- For more information on specifying the settings, refer to the **P-touch Editor Help** menu.

2. Use P-touch Editor to transfer a template or label layout from the computer to the printer.

For more information, see *Related Information*.

The linked database file will also be transferred.

3. Select the transferred template, and then click **Transfer** to download the template to the Key Assign number in the printer.

4. Scan the following barcode:





P-touch template command (initialise + begin specifying settings)



Esc]ia3^11

5. From the following barcode list, scan each barcode to send a command or setting to the printer:

Basic settings

<p>Auto cut on (Cut every one label) + Cut at end on</p>  <p>^c01011</p>	<p>Auto cut on (Cut every two labels) + Cut at end on</p>  <p>^c01021</p>
<p>Auto cut off + Cut at end on</p>  <p>^c00001</p>	<p>Auto cut off + Cut at end off</p>  <p>^c00000</p>

Number of copies



- Settings can be made with multiple commands.
- If no settings have been made by scanning the barcode commands, a template is printed using the P-touch Template settings. The default P-touch Template settings are to print a single copy with Auto Cut turned on.

For more information on P-touch Template Settings, see the *P-touch Template Manual/Command Reference* (English only). You can download the latest version from the Brother support website at support.brother.com/manuals.

6. Specify the number of copies you want.

- a. Scan the following barcode:

Number of copies













- b. Scan the following barcodes to specify a three-digit number:

Example:

Specify numbers by scanning the following barcodes: when printing 7 sheets; [0][0][7], when printing 15 sheets; [0][1][5]

For entering numbers

1  1	2  2
3  3	4  4
5  5	6  6
7  7	8  8
9  9	0  0
00  00	



To change the setting for the number of copies, repeat these steps.

7. Scan the following barcode:

Select template













8. Scan the following barcodes with the same number (three digits) as the Key Assign number used for the downloaded template to be printed:

Example:

Specify numbers by scanning the following barcodes: when printing number 7; [0][0][7], when printing number 15; [0][1][5]

For entering numbers

1  1	2  2
3  3	4  4
5  5	6  6
7  7	8  8
9  9	0  0
00  00	

The downloaded template is selected after the three digit numbers have been scanned.



You can use P-touch Editor to create and print a label with a single barcode.

Example:



9. Scan a barcode containing the keyword to look up in the downloaded database.

Example:



10. Scan the following barcode to send the command to start searching the downloaded database for the scanned keyword:

Delimiter



11. Scan the following barcode to send the command to start printing:

Begin printing



You can use P-touch Editor to create and print a label with a single barcode.

Example:



The printer prints the template with the data inserted from the database record, found with the scanned keyword.



Related Information

- [Try the P-touch Template Function Using the Barcode List](#)

Related Topics:

- [Barcodes Used for Specifying Settings](#)
-

Print Transferred Templates in Serialised (Numerical) Order (Numbered (Serialised Number) Printing)

You can increase text numbers or barcodes up to 999 when printing downloaded templates. Select text or barcode objects to increment while printing.

- >> [Text Numbering \(Serialising\)](#)
- >> [Barcode Numbering \(Serialising\)](#)
- >> [Use the Numbering \(Serialising\) Advanced Operation](#)

Text Numbering (Serialising)

1. Use P-touch Editor to create or open a template and select a text object you want to increment while printing.

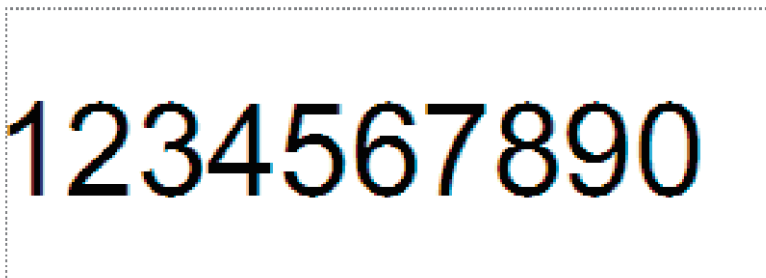

2. Highlight or drag the cursor over a group of numbers and letters within the text object you want to increment. The selected group is called the Numbering field.

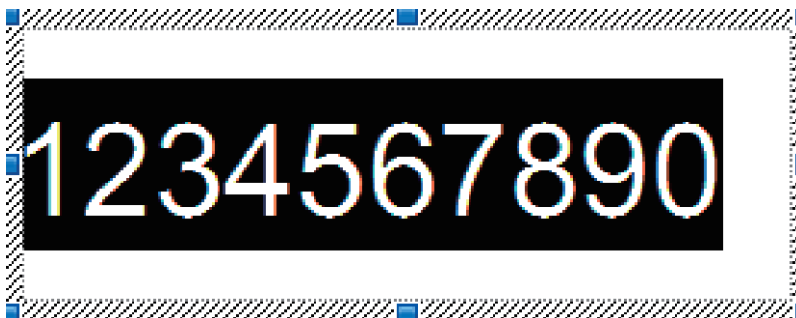

3. When you insert a text object in the P-touch Editor Layout window, the **Expanded** tab will appear in the properties on the right. On the **Text** tab, select the **Numbering** menu.

Barcode Numbering (Serialising)

1. Use P-touch Editor to create or open a template and select a barcode object you want to increment while printing.
2. Click the barcode object, and the **Expanded** tab will appear in the properties on the right. On the **Barcode** tab, select the **Numbering** menu.

Use the Numbering (Serialising) Advanced Operation

1. Use P-touch Editor to transfer a template or label layout from the computer to the printer. For more information, see *Related Information*.
2. Scan the following barcode:

Number of serialised copies













^NN

3. Scan the following barcodes with the number of copies you want to print (three digits):

Example:

For five copies, specify the three digit numbers by scanning barcodes for [0][0][5]

For entering numbers

1 	2 
3 	4 
5 	6 
7 	8 
9 	0 
00 	

4. Follow the P-touch Template mode basic operation procedures to start printing.



- The Numbering field increments by one number or letter with each printed label, and the count is permanently saved in the printer.
- To reset a text or barcode object back to the original value, scan the following barcode:

Initialise template data



Related Information

- [Try the P-touch Template Function Using the Barcode List](#)

Related Topics:

- [Barcodes Used for Specifying Settings](#)

Barcodes Used for Specifying Settings



- When using the barcodes in this list, make the following settings.
 - Printer: Set the **Trigger for P-touch Template Printing** and **Command Prefix Character** options to the factory settings in the P-touch Template Settings tool.
 - Barcode Scanner: Remove any prefix and suffix characters.
- Make sure you print the barcodes at a high resolution so that the barcode scanner can read them correctly to print the labels you want.

P-touch template command (initialise + begin specifying settings)







Basic settings

Auto cut on (Cut every one label) + Cut at end on ^c01011	Auto cut on (Cut every two labels) + Cut at end on ^c01021
Auto cut off + Cut at end on ^c00001	Auto cut off + Cut at end off ^c00000
Number of copies ^CN	











- For entering numbers

These are used when specifying the number of copies printed and when selecting a template number. Scan barcodes to specify a three-digit number, such as [0][0][7] or [0][1][5]. The setting is applied when three digits have been specified. To change settings, scan the “Number of copies” barcode again when changing the number of copies or scan the “Select template” barcode again when changing the template number, and then scan the barcodes for the new three-digit number.

1 1	2 2
3 3	4 4
5 5	6 6

7  7	8  8
9  9	0  0
00  00	

- Preset template number

Preset template 1  ^TS001^FF	Preset template 2  ^TS002^FF
Preset template 3  ^TS003^FF	Preset template 4  ^TS004^FF
Preset template 5  ^TS005^FF	Preset template 6  ^TS006^FF
Preset template 7  ^TS007^FF	Preset template 8  ^TS008^FF
Preset template 9  ^TS009^FF	Preset template 10  ^TS010^FF

- Select template



- Number of serialised copies



- Delimiter



- Initialise template data



^ID

- Begin printing



^FF



Related Information

- [Try the P-touch Template Function Using the Barcode List](#)
-

Transfer Templates to the Printer Using Your Computer (Windows)

- [Notes on Using Transfer Functions \(Windows\)](#)
- [Transfer a Template or Other Data from the Computer to the Printer \(Windows\)](#)
- [Transfer Multiple Items from the Computer to the Printer \(Windows\)](#)
- [Back up Templates or Other Data Saved in the Printer to Your Computer \(Windows\)](#)
- [Delete Printer Data from Your Computer \(Windows\)](#)
- [Create Transfer Files and Transfer Package Files \(Windows\)](#)
- [Distribute Templates to be Transferred to Users](#)

Notes on Using Transfer Functions (Windows)

Some P-touch Editor functions are not available with the printer, so keep the following points in mind when using P-touch Editor to create templates.

You can preview created templates before they are transferred to the printer.

Creating Templates

- Some of the text in the templates transferred to the printer may be printed using similar fonts and character sizes loaded in the printer. As a result, the printed label may differ from the image of the template created in P-touch Editor.
- Depending on the text object setting, the character size may be automatically reduced or some of the text may not be printed. If this occurs, change the Text Object setting.
- Although character styles can be applied to individual characters in P-touch Editor, styles can be applied to a block of text only from the printer. In addition, some character styles are not available on the printer.
- Backgrounds specified in P-touch Editor are not compatible with the printer.
- The P-touch Editor layout using the split printing function (enlarging the label and printing it on two or more labels) cannot be transferred.
- Only the portion of the label within the printable area is printed.

Transferring Templates

- The printed label may differ from the image in the preview area of P-touch Editor.
- If a two-dimensional barcode that the printer does not support is transferred to the printer, the barcode is converted into an image. The image of the converted barcode cannot be edited. This printer supports only a QR code or Data Matrix.
- All transferred objects that cannot be edited by the printer are converted into images.
- Grouped objects are converted into a single bitmap.
- If objects overlap, only the bottom object is printed.

Transferring Data Other Than Templates

If the number or order of fields in a database is changed and only the database (CSV file) is transferred to update it, the database may not link correctly to the template. The first line of data in the transferred file must be recognised by the printer as "field names".

Transferring a Template and Database Together

The latest P-touch Editor supports LBXS files with which a template and database can be transferred as a single file.



Related Information

- [Transfer Templates to the Printer Using Your Computer \(Windows\)](#)

Transfer a Template or Other Data from the Computer to the Printer (Windows)

1. Connect the printer to the computer using a USB cable, and then turn the printer on.
2. Start P-touch Editor .

Click **Start > Brother P-touch > P-touch Editor**, or double-click the **P-touch Editor** icon on the desktop.

NOTE

Depending on your computer's operating system, the Brother P-touch folder may or may not be created.

3. Make sure your model's name is selected on the Home screen.
4. Open the template you want or create a new layout.
5. Click **File > Transfer Template**.

The Transfer window appears. The template or other data is listed in the window under **Transfer Name** .

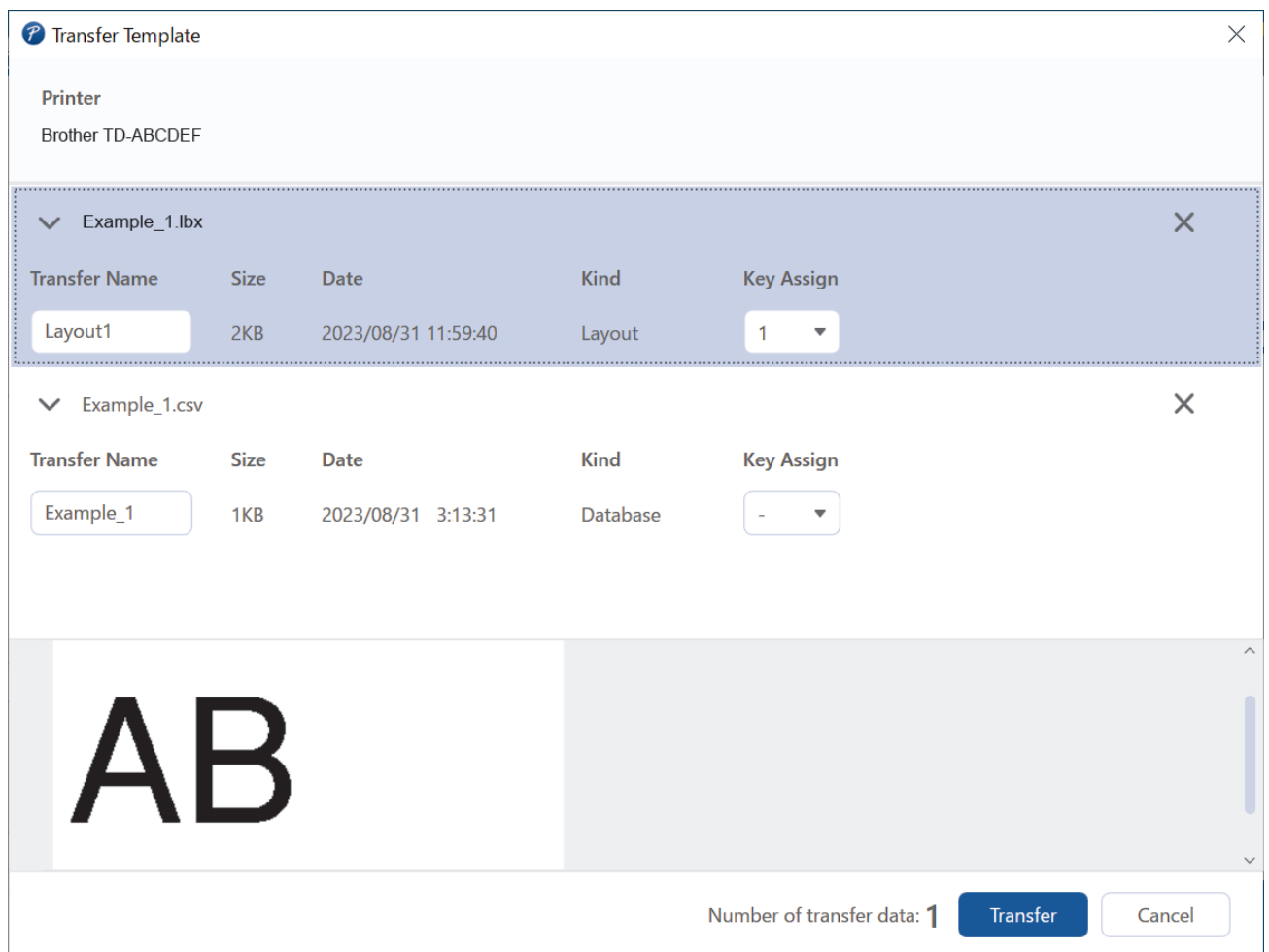

6. To change the **Key Assign** number, that is, the file location in the printer, assigned to a template, click the template file you want, and then select the **Key Assign** number.



Use Key Assign numbers to search for template files on your printer.

NOTE

- The database is not assigned a Key Assign number.

-
- The printer will overwrite any previously saved template that has the same Key Assign number as a new template being transferred to it.

7. To change the transfer name of the template or other data, click the item you want, and then type the new name.

The number of characters allowed for the file name differs depending on the printer model.

8. From the file list, select the template or other data you want to transfer, and then click **Transfer**.

9. Click **OK**.

The selected items are transferred to the printer.



You can transfer multiple templates or other data at the same time. For more information, see *Related Topics: Transfer Multiple Items from the Computer to the Printer (Windows)*.



Related Information

- [Standalone Printing](#)
- [Print Labels Using Barcode Scanner or Other Devices \(P-touch Template\)](#)
- [Transfer Templates to the Printer Using Your Computer \(Windows\)](#)

Related Topics:

- [Transfer Templates Created on a Computer to the Printer Using a Mobile Device](#)
 - [Confirm Printer Settings](#)
 - [Transfer Multiple Items from the Computer to the Printer \(Windows\)](#)
-

Transfer Multiple Items from the Computer to the Printer (Windows)

When you transfer multiple items using P-touch Editor, follow these guidelines.

Data Type	Maximum Number of Transferable Items	Restriction Details
Template	255	Each template can contain up to 255 objects (text and barcodes).
Database	255	<ul style="list-style-type: none">• Only CSV files can be transferred.• Each CSV file can contain a maximum of 100 columns and 65000 records.
Image (transferred symbols)	255	<ul style="list-style-type: none">• Only *.bmp files can be transferred.• Monochrome *.bmp files are recommended.• The size limit is 1296 x 1296 pixels.• Wide images may be cropped.

The user ROM storage capacity is 8 MB for TD-2310D and 32 MB for other models.

1. Connect the printer to the computer using a USB cable, and then turn the printer on.
2. Start P-touch Editor .

Click **Start > Brother P-touch > P-touch Editor**, or double-click the **P-touch Editor** icon on the desktop.

NOTE

Depending on your computer's operating system, the Brother P-touch folder may or may not be created.

3. Make sure your model's name is selected on the Home screen, and then click **Transfer**.
4. In the **Transfer** window, click **Browse** and specify the items you want to transfer.
The specified items appear in the file list.
5. Make sure the items you want to transfer are selected in the file list, and then click **Transfer**.
6. Click **OK**.
The selected items are transferred to the printer.

Related Information

- [Standalone Printing](#)
- [Print Labels Using Barcode Scanner or Other Devices \(P-touch Template\)](#)
- [Transfer Templates to the Printer Using Your Computer \(Windows\)](#)

Related Topics:

- [Transfer a Template or Other Data from the Computer to the Printer \(Windows\)](#)

Back up Templates or Other Data Saved in the Printer to Your Computer (Windows)

Use P-touch Transfer Manager to back up templates or other data saved in the printer to your computer. P-touch Transfer Manager is installed with P-touch Editor 5.4, which may be an earlier version of P-touch Editor than you are currently using. To download P-touch Editor 5.4, search for the applicable **FAQs & Troubleshooting** tip at support.brother.com.



- Backed-up templates and other data cannot be edited on the computer.
- Depending on the printer model, backed-up templates and data may not be transferable between different models.

1. Start P-touch Editor 5.4.

Click **Start > Brother P-touch > P-touch Editor**, or double-click the **P-touch Editor** icon on the desktop. Depending on your computer's operating system, the Brother P-touch folder may or may not be created.

2. Open the P-touch Transfer Manager window.

Click **File > Transfer Template > Transfer**.

3. Connect your computer to the printer and turn the printer on.

The printer model name appears next to a printer icon in the folder view of the P-touch Transfer Manager window.

4. Select the printer to back up from, and then click **Backup**.

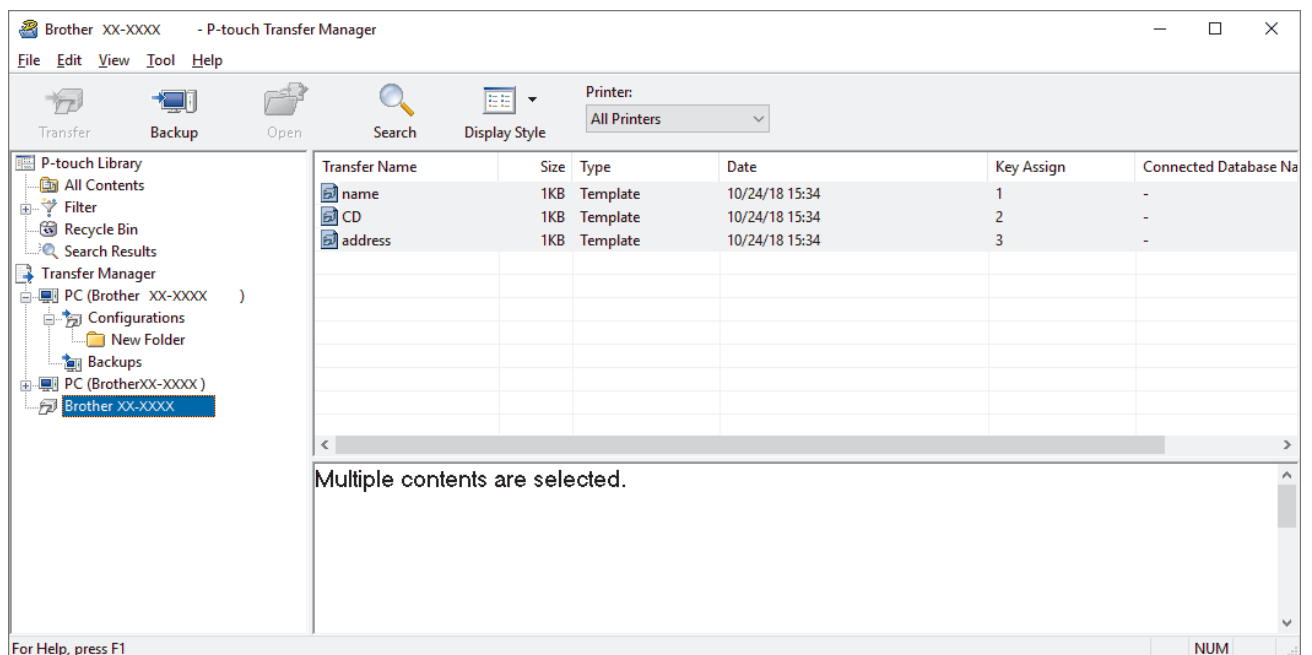

A confirmation message appears.

5. Click **OK**.

A new folder is created under the printer in the folder view. The folder name is based on the date and time of the backup. All of the printer's templates and other data are transferred to the new folder and saved on your computer.



Related Information

- [Transfer Templates to the Printer Using Your Computer \(Windows\)](#)

Delete Printer Data from Your Computer (Windows)

Use P-touch Transfer Manager to delete printer data from your computer. P-touch Transfer Manager is installed with P-touch Editor 5.4, which may be an earlier version of P-touch Editor than you are currently using. To download P-touch Editor 5.4, search for the applicable **FAQs & Troubleshooting** tip at support.brother.com.

1. Start P-touch Editor 5.4.
Click **Start > Brother P-touch > P-touch Editor**, or double-click the **P-touch Editor** icon on the desktop. Depending on your computer's operating system, the Brother P-touch folder may or may not be created.
2. Open the P-touch Transfer Manager window.
Click **File > Transfer Template > Transfer**.
3. Connect your computer to the printer and turn the printer on.
The printer model name appears next to a printer icon in the folder view of the P-touch Transfer Manager window.
4. Right-click the printer, and then select the **Delete All** menu.

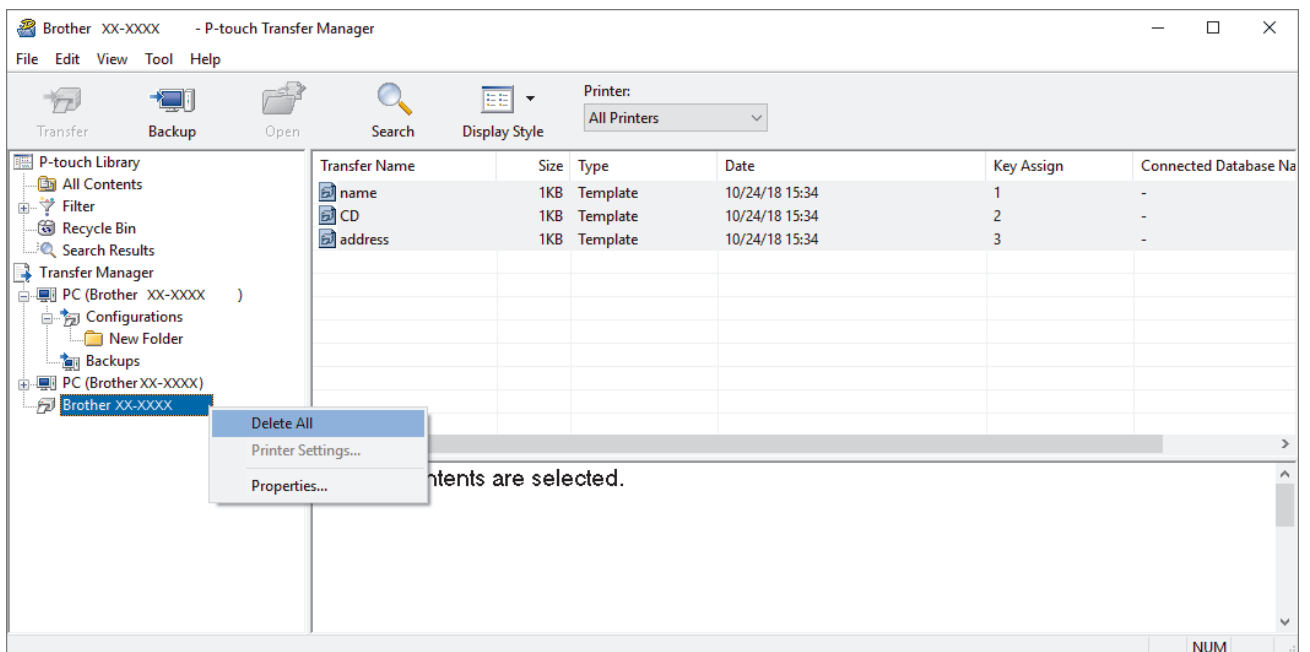

A confirmation message appears.

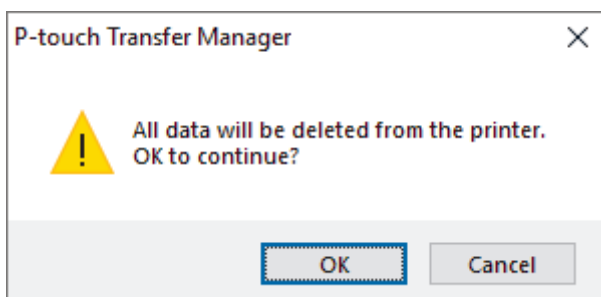

5. Click **OK**.
All templates and other data saved on the printer are deleted.

✓ Related Information

- [Transfer Templates to the Printer Using Your Computer \(Windows\)](#)

Create Transfer Files and Transfer Package Files (Windows)

Create transfer files (BLF) or transfer package files (PDZ) with templates enclosed, so that these templates can be used on other remote printers.

You can also print files in the BLF format using Mass Storage Mode.

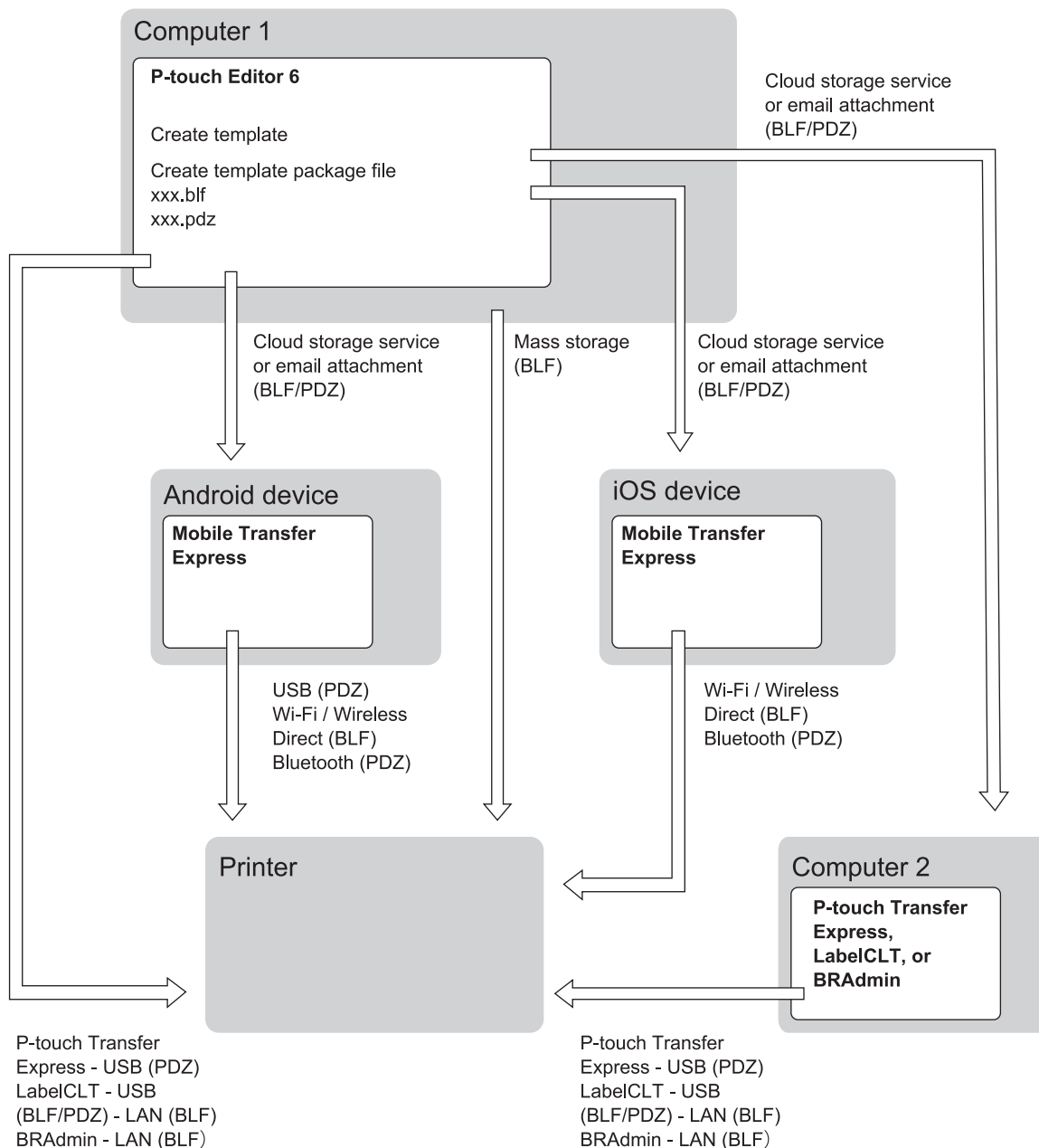

Template Transfer Method		File Format
From a mobile device (Using Mobile Transfer Express)	via USB	PDZ
	via Wi-Fi (TD-2350D/TD-2350DF/ TD-2350DSA)	BLF
	via Wireless Direct (TD-2350D/ TD-2350DF/TD-2350DSA)	BLF
	via Bluetooth	PDZ

Template Transfer Method		File Format
	Mass storage	BLF
From a computer	P-touch Transfer Express	PDZ
	Mass storage	BLF

1. Connect the printer to the computer using a USB cable, and then turn the printer on.
2. Start P-touch Editor .

Click **Start > Brother P-touch > P-touch Editor**, or double-click the **P-touch Editor** icon on the desktop.

NOTE

Depending on your computer's operating system, the Brother P-touch folder may or may not be created.

3. Make sure your model's name is selected on the Home screen, and then click **Transfer**.
4. In the **Transfer** window, click **Browse** and specify the items you want to transfer.
The specified items appear in the file list.
5. Make sure the items you want to export are selected in the file list, and then click **Export**.
6. Specify the file path, the file name, and select Transfer files (BLF) or Transfer Package files (PDZ) as the file type.
7. Click **Save**.



Related Information

- [Transfer Templates to the Printer Using Your Computer \(Windows\)](#)

Distribute Templates to be Transferred to Users

Transfer templates to the printer using P-touch Transfer Express.

To download the latest version of P-touch Transfer Express, go to your model's **Downloads** page on the Brother support website at support.brother.com.



- When transferring a new template, make sure you specify a Key Assign number (in P-touch Editor) that is not currently used. If the specified Key Assign number is already being used, the existing template will be overwritten with the new one.
- This function requires a USB connection.

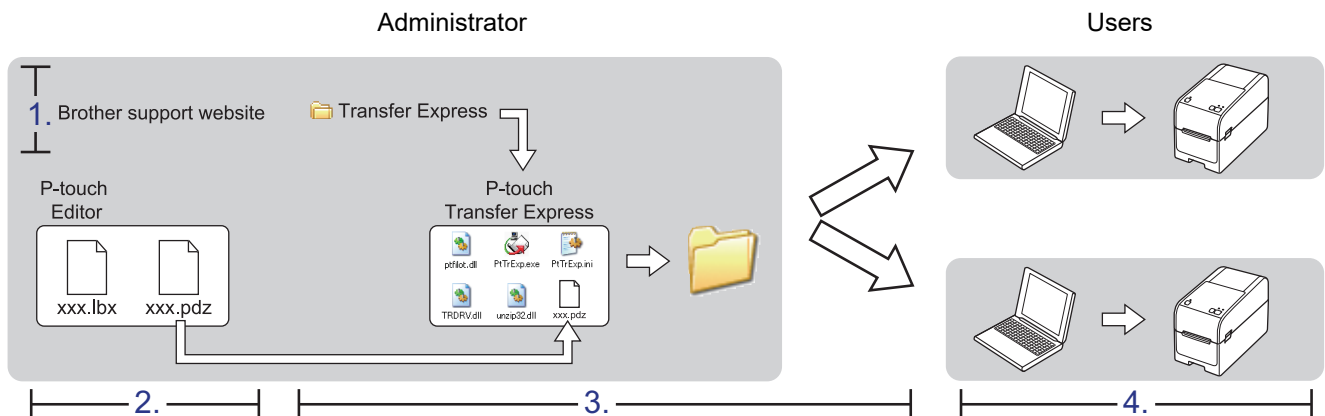

>> [Administrator Tasks](#)

>> [User Tasks](#)

Administrator Tasks

>> [Preparing P-touch Transfer Express](#)

>> [Save the Template as a Transfer Package File \(PDZ\)](#)

>> [Distribute the Transfer Package File \(PDZ\) and P-touch Transfer Express to Others](#)

Preparing P-touch Transfer Express

The printer driver must be installed before using P-touch Transfer Express.



P-touch Transfer Express is available only in English.

1. Download P-touch Transfer Express to any location on the computer.
2. Decompress the downloaded file (ZIP).

Save the Template as a Transfer Package File (PDZ)

To create a file in a format that can be used by P-touch Transfer Express, save the template as a Transfer Package file (PDZ).

1. Connect the printer to the computer using a USB cable, and then turn the printer on.
2. Start P-touch Editor .

Click **Start > Brother P-touch > P-touch Editor**, or double-click the **P-touch Editor** icon on the desktop.

NOTE

Depending on your computer's operating system, the Brother P-touch folder may or may not be created.

3. Make sure your model's name is selected on the Home screen, and then click **Transfer**.
4. In the **Transfer** window, click **Browse** and specify the items you want to transfer.
The specified items appear in the file list.
5. Make sure the items you want to export are selected in the file list, and then click **Export**.
6. Specify the file path, the file name, and select Transfer Package file (PDZ) as the file type.
7. Click **Save**.
The template is saved as a Transfer Package file (PDZ).

Distribute the Transfer Package File (PDZ) and P-touch Transfer Express to Others



If you already downloaded P-touch Transfer Express, it is not necessary for the administrator to send the Transfer Express folder. In this case, you can simply move the distributed Transfer Package file to the downloaded folder, and then double-click the **PtTrExp.exe** file.

1. Move the Transfer Package file (PDZ) to the downloads folder.

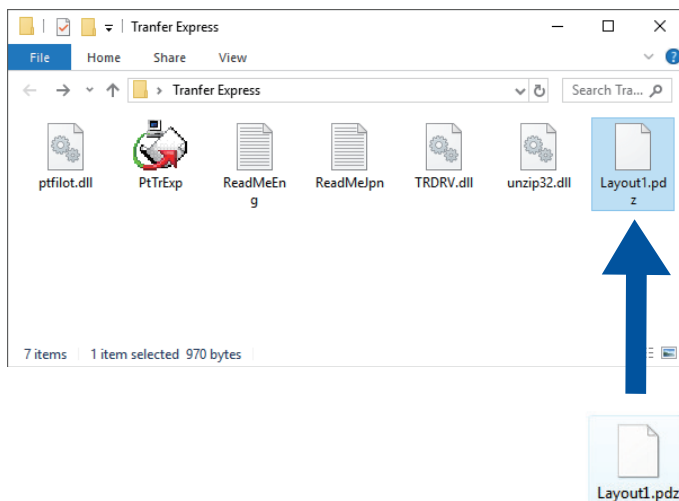

2. Distribute all the files in the downloads folder to others.

User Tasks

Transfer the Transfer Package File (PDZ) to your printer



Do not turn the power off when transferring templates.

1. Turn the printer on.
2. Connect the printer to the computer using a USB cable.
3. Double-click the **PtTrExp.exe** file received from the administrator.
4. Do one of the following:
 - To transfer a single Transfer Package file (PDZ) within the folder containing the **PtTrExp.exe** file, click **Transfer**.
 - To transfer multiple Transfer Package files (PDZ) within the folder containing the **PtTrExp.exe** file, do the following:
 - a. Click **Browse**.

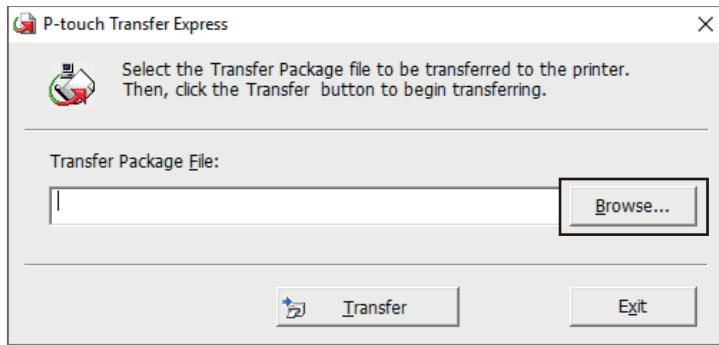

- b. Select the Transfer Package file you want to transfer, and then click **Open**.
 - c. Click **Transfer**.
 - d. Click **Yes**.
5. When completed, click **OK**.



Related Information

- [Transfer Templates to the Printer Using Your Computer \(Windows\)](#)

Network

Related Models: TD-2320D/TD-2350D/TD-2320DF/TD-2350DF/TD-2320DSA/TD-2350DSA

- [Important Information for Security](#)
- [Wireless Network Settings](#)
- [Network Features](#)
- [Brother Management Tools](#)
- [Change Printer Settings Using Web Based Management](#)

Important Information for Security

- The default password to manage this machine's settings is located on the bottom of the machine and marked "**Pwd:**". We recommend immediately changing the default password to protect your machine from unauthorised access.
- When connecting your machine to an outside network such as the Internet, make sure your network environment is protected by a separate firewall or other means in order to prevent information leaks due to inadequate settings or unauthorised access by malicious third parties.
- If there is a signal in the vicinity, wireless LAN allows you to freely make a LAN connection. However, if security settings are not correctly configured, the signal may be intercepted by malicious third-parties, possibly resulting in:
 - Theft of personal or confidential information
 - Improper transmission of information to parties impersonating the specified individuals
 - Dissemination of transcribed communication contents that were intercepted



Related Information

- [Network](#)
-

Wireless Network Settings

Related Models: TD-2350D/TD-2350DF/TD-2350DSA

- [Use the Wireless Network](#)
- [Enable/Disable Wi-Fi](#)

Use the Wireless Network

Related Models: TD-2350D/TD-2350DF/TD-2350DSA

- [Before Configuring Your Machine for a Wireless Network](#)

Before Configuring Your Machine for a Wireless Network

Related Models: TD-2350D/TD-2350DF/TD-2350DSA

Before attempting to configure a wireless network, confirm the following:

- If you are using an enterprise wireless network, you must know the User ID and Password.
- To achieve optimum results with normal everyday document printing, place your machine as close to the wireless LAN access point/router as possible with minimal obstructions. Large objects and walls between the two devices and interference from other electronic devices can affect the data transfer speed of your documents.

Due to these factors, wireless may not be the best method of connection for all types of documents and applications.

- If there is a signal in the vicinity, wireless LAN allows you to freely make a LAN connection. However, if security settings are not correctly configured, the signal may be intercepted by malicious third parties, possibly resulting in:
 - Theft of personal or confidential information
 - Improper transmission of information to parties impersonating the specified individuals
 - Dissemination of transcribed communication contents that were intercepted



Make sure you know your wireless router/access point's Network Name (SSID) and Network Key (Password). If you cannot find this information, consult the manufacturer of your wireless router/access point, your system administrator, or Internet provider. Brother cannot provide this information.



Related Information

- [Use the Wireless Network](#)

Enable/Disable Wi-Fi

Related Models: TD-2350D/TD-2350DF/TD-2350DSA

1. Press **Menu**.
2. Press **▲** or **▼** to select the following:
 - a. Select [WLAN]. Press **OK**.
 - b. Select [WLAN (On/Off)]. Press **OK**.
3. Press **▲** or **▼** to select one of the following:
 - Select [On] to enable Wi-Fi. Press **OK**.
 - Select [Off] to disable Wi-Fi. Press **OK**.



Related Information

- [Wireless Network Settings](#)

Network Features

Related Models: TD-2320D/TD-2350D/TD-2320DF/TD-2350DF/TD-2320DSA/TD-2350DSA

- [Synchronise Time with the SNTP Server Using Web Based Management](#)

Synchronise Time with the SNTP Server Using Web Based Management

Related Models: TD-2320D/TD-2350D/TD-2320DF/TD-2350DF/TD-2320DSA/TD-2350DSA

The Simple Network Time Protocol (SNTP) is used to synchronise the time used by the machine for authentication with the SNTP time server. You can automatically or manually synchronise the machine's time with the Coordinated Universal Time (UTC) provided by the SNTP time server.

- [Configure Date and Time Using Web Based Management](#)
- [Configure the SNTP Protocol Using Web Based Management](#)

Configure Date and Time Using Web Based Management

Related Models: TD-2320D/TD-2350D/TD-2320DF/TD-2350DF/TD-2320DSA/TD-2350DSA

Configure the date and time to synchronise the time used by the machine with the SNTP time server.

This feature is not available in some countries.

1. Start your web browser.
2. Type "https://machine's IP address" in your browser's address bar (where "machine's IP address" is your machine's IP address).

For example:

https://192.168.1.2

3. If required, type the password in the **Login** field, and then click **Login**.



The default password to manage this machine's settings is located on the bottom of the machine and marked "**Pwd:**". Change the default password by following the on-screen instructions when you first log in. If the Battery Base is installed, uninstall it to confirm the default password.

4. In the left navigation bar, click **Administrator** > **Date&Time**.



If the left navigation bar is not visible, start navigating from ☰.

5. Verify the **Time Zone** settings.



Select the time difference between your location and UTC from the **Time Zone** drop-down list. For example, the time zone for Eastern Time in the USA and Canada is UTC-05:00.

6. Click **Submit**.



Related Information

- [Synchronise Time with the SNTP Server Using Web Based Management](#)

Configure the SNTP Protocol Using Web Based Management

Related Models: TD-2320D/TD-2350D/TD-2320DF/TD-2350DF/TD-2320DSA/TD-2350DSA

Configure the SNTP protocol to synchronise the time the machine uses for authentication with the time kept by the SNTP time server.

1. Start your web browser.
2. Type "https://machine's IP address" in your browser's address bar (where "machine's IP address" is your machine's IP address).

For example:

https://192.168.1.2

3. If required, type the password in the **Login** field, and then click **Login**.



The default password to manage this machine's settings is located on the bottom of the machine and marked "Pwd:". Change the default password by following the on-screen instructions when you first log in. If the Battery Base is installed, uninstall it to confirm the default password.

4. In the left navigation bar, click **Network > Network > Protocol**.



If the left navigation bar is not visible, start navigating from ☰.

5. Select the **SNTP** checkbox to activate the settings.
6. Click **Submit**.
7. Restart your Brother machine to activate the configuration.
8. Next to the SNTP checkbox, click **Advanced Settings**.
9. Configure the settings.

Option	Description
Status	Displays whether the SNTP protocol is enabled or disabled.
Synchronization Status	Confirm the latest synchronisation status.
SNTP Server Method	Select AUTO or STATIC . <ul style="list-style-type: none"> • AUTO If you have a DHCP server on your network, the SNTP server will obtain the address from that server automatically. • STATIC Type the address you want to use.
Primary SNTP Server Address Secondary SNTP Server Address	Type the server's address (up to 64 characters). The secondary SNTP server's address is used as a backup to the primary SNTP server's address. If the primary server is unavailable, the machine will contact the secondary SNTP server.
Primary SNTP Server Port Secondary SNTP Server Port	Type the port number (1-65535). The secondary SNTP server port is used as a backup to the primary SNTP server port. If the primary port is unavailable, the machine will contact the secondary SNTP port.
Synchronization Interval	Type the number of hours between server synchronisation attempts (1-168 hours).

10. Click **Submit**.



Related Information

- [Synchronise Time with the SNTP Server Using Web Based Management](#)
-

Brother Management Tools

Related Models: TD-2320D/TD-2350D/TD-2320DF/TD-2350DF/TD-2320DSA/TD-2350DSA

Use one of Brother's management tools to configure your Brother machine's network settings. Go to your model's **Downloads** page at support.brother.com/downloads to download the tools.



Related Information

- [Network](#)
-

Security

Related Models: TD-2320D/TD-2350D/TD-2320DF/TD-2350DF/TD-2320DSA/TD-2350DSA

- [Before Using Network Security Features](#)
- [Configure Certificates for Device Security](#)
- [Use SSL/TLS](#)
- [Use SNMPv3](#)
- [Use IEEE 802.1x Authentication for Your Network](#)

Before Using Network Security Features

Related Models: TD-2320D/TD-2350D/TD-2320DF/TD-2350DF/TD-2320DSA/TD-2350DSA

Your machine employs some of the latest network security and encryption protocols available today. These network features can be integrated into your overall network security plan to help protect your data and prevent unauthorised access to the machine.



We recommend disabling the FTP and TFTP protocols. Accessing the machine using these protocols is not secure.



Related Information

- [Security](#)

Configure Certificates for Device Security

Related Models: TD-2320D/TD-2350D/TD-2320DF/TD-2350DF/TD-2320DSA/TD-2350DSA

You must configure a certificate to manage your networked machine securely using SSL/TLS. You must use Web Based Management to configure a certificate.

- [Security Certificate Features Overview](#)
- [How to Create and Install a Certificate](#)
- [Create a Self-signed Certificate](#)
- [Create a Certificate Signing Request \(CSR\) and Install a Certificate from a Certificate Authority \(CA\)](#)
- [Import and Export the Certificate and Private Key](#)
- [Import and Export a CA Certificate](#)
- [Manage Multiple Certificates](#)

Security Certificate Features Overview

Related Models: TD-2320D/TD-2350D/TD-2320DF/TD-2350DF/TD-2320DSA/TD-2350DSA

Your machine supports the use of multiple security certificates, which allows secure management, authentication, and communication with the machine. The following security certificate features can be used with the machine:

- SSL/TLS communication
- IEEE 802.1x authentication

Your machine supports the following:

- Pre-installed certificate

Your machine has a pre-installed self-signed certificate. This certificate enables you to use SSL/TLS communication without creating or installing a different certificate.



The pre-installed self-signed certificate protects your communication up to a certain level. We recommend using a certificate that is issued by a trusted organisation for better security.

- Self-signed certificate

This print server issues its own certificate. Using this certificate, you can easily use the SSL/TLS communication without creating or installing a different certificate from a CA.

- Certificate from a Certificate Authority (CA)

There are two methods for installing a certificate from a CA. If you already have a certificate from a CA or if you want to use a certificate from an external trusted CA:

- When using a Certificate Signing Request (CSR) from this print server.
- When importing a certificate and a private key.

- Certificate Authority (CA) Certificate

To use a CA certificate that identifies the CA and owns its private key, you must import that CA certificate from the CA before configuring the security features of the Network.



- If you are going to use SSL/TLS communication, we recommend contacting your system administrator first.
- When you reset the print server back to its default factory settings, the certificate and the private key that are installed will be deleted. If you want to keep the same certificate and the private key after resetting the print server, export them before resetting, and then reinstall them.



Related Information

- [Configure Certificates for Device Security](#)

How to Create and Install a Certificate

Related Models: TD-2320D/TD-2350D/TD-2320DF/TD-2350DF/TD-2320DSA/TD-2350DSA

There are two options when choosing a security certificate: use a self-signed certificate or use a certificate from a Certificate Authority (CA).

Option 1

Self-Signed Certificate

1. Create a self-signed certificate using Web Based Management.
2. Install the self-signed certificate on your computer.

Option 2

Certificate from a CA

1. Create a Certificate Signing Request (CSR) using Web Based Management.
2. Install the certificate issued by the CA on your Brother machine using Web Based Management.
3. Install the certificate on your computer.



Related Information

- [Configure Certificates for Device Security](#)

Create a Self-signed Certificate

Related Models: TD-2320D/TD-2350D/TD-2320DF/TD-2350DF/TD-2320DSA/TD-2350DSA

1. Start your web browser.
2. Type "https://machine's IP address" in your browser's address bar (where "machine's IP address" is your machine's IP address).

For example:

https://192.168.1.2



- If you are using a Domain Name System or enable a NetBIOS name, you can type another name, such as "SharedPrinter" instead of the IP address.

For example: https://SharedPrinter

- If you enable a NetBIOS name, you can also use the node name.
For example: https://brn123456abcdef
- The NetBIOS name can be found in the Network Configuration Report.

3. If required, type the password in the **Login** field, and then click **Login**.



The default password to manage this machine's settings is located on the bottom of the machine and marked "**Pwd:**". Change the default password by following the on-screen instructions when you first log in. If the Battery Base is installed, uninstall it to confirm the default password.

4. In the left navigation bar, click **Network > Security > Certificate**.



If the left navigation bar is not visible, start navigating from ☰.

5. Click **Create Self-Signed Certificate**.
6. Enter a **Common Name** and a **Valid Date**.
 - The length of the **Common Name** is less than 64 bytes. Enter an identifier, such as an IP address, node name, or domain name to use when accessing this machine through SSL/TLS communication. The node name is displayed by default.
 - A warning will appear if you use the IPPS or HTTPS protocol and enter a different name in the URL than the **Common Name** that was used for the self-signed certificate.
7. Select your setting from the **Public Key Algorithm** drop-down list.
8. Select your setting from the **Digest Algorithm** drop-down list.
9. Click **Submit**.



Related Information

- [Configure Certificates for Device Security](#)

Create a Certificate Signing Request (CSR) and Install a Certificate from a Certificate Authority (CA)

Related Models: TD-2320D/TD-2350D/TD-2320DF/TD-2350DF/TD-2320DSA/TD-2350DSA

If you already have a certificate from an external trusted Certificate Authority (CA), you can store the certificate and private key on the machine and manage them by importing and exporting. If you do not have a certificate from an external trusted CA, create a Certificate Signing Request (CSR), send it to a CA for authentication, and install the returned certificate on your machine.

- [Create a Certificate Signing Request \(CSR\)](#)
- [Install a Certificate on Your Machine](#)

Create a Certificate Signing Request (CSR)

Related Models: TD-2320D/TD-2350D/TD-2320DF/TD-2350DF/TD-2320DSA/TD-2350DSA

A Certificate Signing Request (CSR) is a request sent to a Certificate Authority (CA) to authenticate the credentials contained within the certificate.

We recommend installing a Root Certificate from the CA on your computer before creating the CSR.

1. Start your web browser.
2. Type "https://machine's IP address" in your browser's address bar (where "machine's IP address" is your machine's IP address).

For example:

https://192.168.1.2



- If you are using a Domain Name System or enable a NetBIOS name, you can type another name, such as "SharedPrinter" instead of the IP address.

For example: https://SharedPrinter

- If you enable a NetBIOS name, you can also use the node name.

For example: https://brn123456abcdef

- The NetBIOS name can be found in the Network Configuration Report.

3. If required, type the password in the **Login** field, and then click **Login**.



The default password to manage this machine's settings is located on the bottom of the machine and marked "**Pwd:**". Change the default password by following the on-screen instructions when you first log in. If the Battery Base is installed, uninstall it to confirm the default password.

4. In the left navigation bar, click **Network > Security > Certificate**.



If the left navigation bar is not visible, start navigating from ☰.

5. Click **Create CSR**.

6. Type a **Common Name** (required) and add other information about your **Organization** (optional).



- Your company details are required so that a CA can confirm your identity and verify it to the outside world.
- The length of the **Common Name** must be less than 64 bytes. Enter an identifier, such as an IP address, node name, or domain name to use when accessing this printer through SSL/TLS communication. The node name is displayed by default. The **Common Name** is required.
- A warning will appear if you type a different name in the URL than the Common Name that was used for the certificate.
- The length of the **Organization**, the **Organization Unit**, the **City/Locality** and the **State/Province** must be less than 64 bytes.
- The **Country/Region** should be a two character ISO 3166 country code.
- If you are configuring an X.509v3 certificate extension, select the **Configure extended partition** checkbox, and then select **Auto (Register IPv4)** or **Manual**.

7. Select your setting from the **Public Key Algorithm** drop-down list. The default setting is **RSA(2048bit)**.

8. Select your setting from the **Digest Algorithm** drop-down list. The default setting is **SHA256**.

9. Click **Submit**.

The CSR appears on your screen. Save the CSR as a file or copy and paste it into an online CSR form offered by a Certificate Authority.

10. Click **Save**.



- Follow your CA's policy regarding the method to send a CSR to your CA.
- If you are using the Enterprise root CA of Windows Server 2012/2012 R2/2016/2019, we recommend using the Web Server for the certificate template to securely create the Client Certificate. If you are creating a Client Certificate for an IEEE 802.1x environment with EAP-TLS authentication, we recommend using User for the certificate template.

For more information, visit support.brother.com, to see the **FAQs & Troubleshooting** page of your model.

Search for "SSL".



Related Information

- [Create a Certificate Signing Request \(CSR\) and Install a Certificate from a Certificate Authority \(CA\)](#)
-

Install a Certificate on Your Machine

Related Models: TD-2320D/TD-2350D/TD-2320DF/TD-2350DF/TD-2320DSA/TD-2350DSA

When you receive a certificate from a Certificate Authority (CA), follow the steps below to install it on the print server:

Only a certificate issued with your machine's Certificate Signing Request (CSR) can be installed on your machine. When you want to create another CSR, make sure that the certificate is installed before creating the new CSR. Create another CSR only after installing the certificate on the machine, otherwise the CSR created before installing the new CSR will be invalid.

1. Start your web browser.
2. Type "https://machine's IP address" in your browser's address bar (where "machine's IP address" is your machine's IP address).

For example:

https://192.168.1.2



- If you are using a Domain Name System or enable a NetBIOS name, you can type another name, such as "SharedPrinter" instead of the IP address.

For example: https://SharedPrinter

- If you enable a NetBIOS name, you can also use the node name.

For example: https://brn123456abcdef

- The NetBIOS name can be found in the Network Configuration Report.

3. If required, type the password in the **Login** field, and then click **Login**.



The default password to manage this machine's settings is located on the bottom of the machine and marked "**Pwd:**". Change the default password by following the on-screen instructions when you first log in. If the Battery Base is installed, uninstall it to confirm the default password.

4. In the left navigation bar, click **Network > Security > Certificate**.



If the left navigation bar is not visible, start navigating from ☰.

5. Click **Install Certificate**.
6. Browse to the file that contains the certificate issued by the CA, and then click **Submit**.
The certificate has been created and saved in your machine's memory successfully.

To use SSL/TLS communication, the Root Certificate from the CA must be installed on your computer. Contact your network administrator.



Related Information

- [Create a Certificate Signing Request \(CSR\) and Install a Certificate from a Certificate Authority \(CA\)](#)

Import and Export the Certificate and Private Key

Related Models: TD-2320D/TD-2350D/TD-2320DF/TD-2350DF/TD-2320DSA/TD-2350DSA

Store the certificate and private key on your machine and manage them by importing and exporting them.

- [Import a Certificate and Private Key](#)
- [Export the Certificate and Private Key](#)

Import a Certificate and Private Key

Related Models: TD-2320D/TD-2350D/TD-2320DF/TD-2350DF/TD-2320DSA/TD-2350DSA

1. Start your web browser.
2. Type "https://machine's IP address" in your browser's address bar (where "machine's IP address" is your machine's IP address).

For example:

https://192.168.1.2



- If you are using a Domain Name System or enable a NetBIOS name, you can type another name, such as "SharedPrinter" instead of the IP address.

For example: https://SharedPrinter

- If you enable a NetBIOS name, you can also use the node name.
For example: https://brn123456abcdef
- The NetBIOS name can be found in the Network Configuration Report.

3. If required, type the password in the **Login** field, and then click **Login**.



The default password to manage this machine's settings is located on the bottom of the machine and marked "**Pwd:**". Change the default password by following the on-screen instructions when you first log in. If the Battery Base is installed, uninstall it to confirm the default password.

4. In the left navigation bar, click **Network > Security > Certificate**.



If the left navigation bar is not visible, start navigating from ☰.

5. Click **Import Certificate and Private Key**.
6. Browse to the file you want to import.
7. Type the password if the file is encrypted, and then click **Submit**.

The certificate and private key are imported to your machine.



Related Information

- [Import and Export the Certificate and Private Key](#)

Export the Certificate and Private Key

Related Models: TD-2320D/TD-2350D/TD-2320DF/TD-2350DF/TD-2320DSA/TD-2350DSA

1. Start your web browser.
2. Type "https://machine's IP address" in your browser's address bar (where "machine's IP address" is your machine's IP address).

For example:

https://192.168.1.2



- If you are using a Domain Name System or enable a NetBIOS name, you can type another name, such as "SharedPrinter" instead of the IP address.

For example: https://SharedPrinter

- If you enable a NetBIOS name, you can also use the node name.
For example: https://brn123456abcdef
- The NetBIOS name can be found in the Network Configuration Report.

3. If required, type the password in the **Login** field, and then click **Login**.



The default password to manage this machine's settings is located on the bottom of the machine and marked "**Pwd:**". Change the default password by following the on-screen instructions when you first log in. If the Battery Base is installed, uninstall it to confirm the default password.

4. In the left navigation bar, click **Network > Security > Certificate**.



If the left navigation bar is not visible, start navigating from ☰.

5. Click **Export** shown with **Certificate List**.
6. Enter the password if you want to encrypt the file.
If a blank password is used, the output is not encrypted.
7. Enter the password again for confirmation, and then click **Submit**.
8. Click **Save**.

The certificate and private key are exported to your computer.

You can also import the certificate to your computer.



Related Information

- [Import and Export the Certificate and Private Key](#)

Import and Export a CA Certificate

Related Models: TD-2320D/TD-2350D/TD-2320DF/TD-2350DF/TD-2320DSA/TD-2350DSA

You can import, export, and store CA certificates on your Brother machine.

- [Import a CA Certificate](#)
- [Export a CA Certificate](#)

Import a CA Certificate

Related Models: TD-2320D/TD-2350D/TD-2320DF/TD-2350DF/TD-2320DSA/TD-2350DSA

1. Start your web browser.
2. Type "https://machine's IP address" in your browser's address bar (where "machine's IP address" is your machine's IP address).

For example:

https://192.168.1.2



- If you are using a Domain Name System or enable a NetBIOS name, you can type another name, such as "SharedPrinter" instead of the IP address.

For example: https://SharedPrinter

- If you enable a NetBIOS name, you can also use the node name.
For example: https://brn123456abcdef
- The NetBIOS name can be found in the Network Configuration Report.

3. If required, type the password in the **Login** field, and then click **Login**.



The default password to manage this machine's settings is located on the bottom of the machine and marked "**Pwd:**". Change the default password by following the on-screen instructions when you first log in. If the Battery Base is installed, uninstall it to confirm the default password.

4. In the left navigation bar, click **Network > Security > CA Certificate**.



If the left navigation bar is not visible, start navigating from ☰.

5. Click **Import CA Certificate**.
6. Browse to the file you want to import.
7. Click **Submit**.



Related Information

- [Import and Export a CA Certificate](#)

Export a CA Certificate

Related Models: TD-2320D/TD-2350D/TD-2320DF/TD-2350DF/TD-2320DSA/TD-2350DSA

1. Start your web browser.
2. Type "https://machine's IP address" in your browser's address bar (where "machine's IP address" is your machine's IP address).

For example:

https://192.168.1.2



- If you are using a Domain Name System or enable a NetBIOS name, you can type another name, such as "SharedPrinter" instead of the IP address.

For example: https://SharedPrinter

- If you enable a NetBIOS name, you can also use the node name.
For example: https://brn123456abcdef
- The NetBIOS name can be found in the Network Configuration Report.

3. If required, type the password in the **Login** field, and then click **Login**.



The default password to manage this machine's settings is located on the bottom of the machine and marked "**Pwd:**". Change the default password by following the on-screen instructions when you first log in. If the Battery Base is installed, uninstall it to confirm the default password.

4. In the left navigation bar, click **Network > Security > CA Certificate**.



If the left navigation bar is not visible, start navigating from ☰.

5. Select the certificate you want to export and click **Export**.
6. Click **Submit**.



Related Information

- [Import and Export a CA Certificate](#)

Manage Multiple Certificates

Related Models: TD-2320D/TD-2350D/TD-2320DF/TD-2350DF/TD-2320DSA/TD-2350DSA

The multiple certificate feature allows you to use Web Based Management to manage each certificate installed on your machine. In Web Based Management, navigate to the **Certificate** or **CA Certificate** screen to view certificate content, delete, or export your certificates.

	Maximum Number of Certificates Stored on Brother Machine
Self-signed Certificate or Certificate Issued by a CA	5
CA Certificate	6

We recommend storing fewer certificates than allowed, reserving an empty spot in case of certificate expiration. When a certificate expires, import a new certificate into the reserved spot, and then delete the expired certificate. This ensures that you avoid configuration failure.



- When you use HTTPS/IPPS, or IEEE 802.1x, you must select which certificate you are using.
- When you use SSL for SMTP communications, you do not have to choose the certificate. The necessary certificate will be chosen automatically.



Related Information

- [Configure Certificates for Device Security](#)

Use SSL/TLS

Related Models: TD-2320D/TD-2350D/TD-2320DF/TD-2350DF/TD-2320DSA/TD-2350DSA

- [Introduction to SSL/TLS](#)
- [Manage Your Network Machine Securely Using SSL/TLS](#)
- [Print Documents Securely Using SSL/TLS](#)

Introduction to SSL/TLS

Related Models: TD-2320D/TD-2350D/TD-2320DF/TD-2350DF/TD-2320DSA/TD-2350DSA

Secure Socket Layer (SSL) or Transport Layer Security (TLS) is an effective method of protecting data sent over a local or wide area network (LAN or WAN). It works by encrypting data, such as a print job, sent over a network, so anyone trying to capture it will not be able to read it.

SSL/TLS can be configured on both wired and wireless networks and will work with other forms of security such as WPA keys and firewalls.



Related Information

- [Use SSL/TLS](#)
 - [Brief History of SSL/TLS](#)
 - [Benefits of Using SSL/TLS](#)

Brief History of SSL/TLS

Related Models: TD-2320D/TD-2350D/TD-2320DF/TD-2350DF/TD-2320DSA/TD-2350DSA

SSL/TLS was originally created to secure web traffic information, particularly data sent between web browsers and servers. SSL is now used with additional applications, such as Telnet, printer, and FTP software, in order to become a universal solution for online security. Its original design intentions are still being used today by many online retailers and banks to secure sensitive data, such as credit card numbers, customer records, etc.

SSL/TLS uses extremely high levels of encryption and is trusted by banks all over the world.



Related Information

- [Introduction to SSL/TLS](#)
-

Benefits of Using SSL/TLS

Related Models: TD-2320D/TD-2350D/TD-2320DF/TD-2350DF/TD-2320DSA/TD-2350DSA

The primary benefit of using SSL/TLS is to guarantee secure printing over an IP network by restricting unauthorised users from reading data sent to the machine. SSL's most important benefit is that it can be used to print confidential data securely. For example, a Human Resource (HR) Department in a large company may be printing wage slips on a regular basis. Without encryption, the data contained on these wages slips can be read by other network users. However, with SSL/TLS, anyone trying to capture the data will see a page of code and not the actual wage slip.



Related Information

- [Introduction to SSL/TLS](#)

Manage Your Network Machine Securely Using SSL/TLS

Related Models: TD-2320D/TD-2350D/TD-2320DF/TD-2350DF/TD-2320DSA/TD-2350DSA

- [Configure a Certificate for SSL/TLS and Available Protocols](#)
- [Access Web Based Management Using SSL/TLS](#)
- [Install the Self-signed Certificate for Windows Users as Administrator](#)

Configure a Certificate for SSL/TLS and Available Protocols

Related Models: TD-2320D/TD-2350D/TD-2320DF/TD-2350DF/TD-2320DSA/TD-2350DSA

Configure a certificate on your machine using Web Based Management before you use SSL/TLS communication.

1. Start your web browser.
2. Type "https://machine's IP address" in your browser's address bar (where "machine's IP address" is your machine's IP address).

For example:

https://192.168.1.2



- If you are using a Domain Name System or enable a NetBIOS name, you can type another name, such as "SharedPrinter" instead of the IP address.

For example: https://SharedPrinter

- If you enable a NetBIOS name, you can also use the node name.
For example: https://brn123456abcdef
- The NetBIOS name can be found in the Network Configuration Report.

3. If required, type the password in the **Login** field, and then click **Login**.



The default password to manage this machine's settings is located on the bottom of the machine and marked "**Pwd:**". Change the default password by following the on-screen instructions when you first log in. If the Battery Base is installed, uninstall it to confirm the default password.

4. In the left navigation bar, click **Network > Network > Protocol**.



If the left navigation bar is not visible, start navigating from ☰.

5. Click **HTTP Server Settings**.
6. Select the certificate you want to configure from the **Select the Certificate** drop-down list.
7. Click **Submit**.
8. Click **Yes** to restart your print server.



Related Information

- [Manage Your Network Machine Securely Using SSL/TLS](#)

Access Web Based Management Using SSL/TLS

Related Models: TD-2320D/TD-2350D/TD-2320DF/TD-2350DF/TD-2320DSA/TD-2350DSA

To manage your network machine securely, use Web Based Management with the HTTPS protocol.



- To use HTTPS protocol, HTTPS must be enabled on your machine. The HTTPS protocol is enabled by default.
- You can change the HTTPS protocol settings using Web Based Management.

1. Start your web browser.
2. Type "https://Common Name" in your browser's address bar (where "Common Name" is the Common Name that you assigned to the certificate; this could be your IP address, node name, or domain name).
3. If required, type the password in the **Login** field, and then click **Login**.



The default password to manage this machine's settings is located on the bottom of the machine and marked "**Pwd:**". Change the default password by following the on-screen instructions when you first log in. If the Battery Base is installed, uninstall it to confirm the default password.

4. You can now access the machine using HTTPS.



Related Information

- [Manage Your Network Machine Securely Using SSL/TLS](#)

Install the Self-signed Certificate for Windows Users as Administrator

Related Models: TD-2320D/TD-2350D/TD-2320DF/TD-2350DF/TD-2320DSA/TD-2350DSA

- The following steps are for Microsoft Edge. If you use another web browser, refer to your web browser's documentation or online help for instructions on how to install certificates.
- Make sure you have created your self-signed certificate using Web Based Management.

1. Right-click the **Microsoft Edge** icon, and then click **Run as administrator**.

If the **User Account Control** screen appears, click **Yes**.

2. Type "https://machine's IP address" in your browser's address bar (where "machine's IP address" is your machine's IP address).

For example:

https://192.168.1.2



- If you are using a Domain Name System or enable a NetBIOS name, you can type another name, such as "SharedPrinter" instead of the IP address.

For example: https://SharedPrinter

- If you enable a NetBIOS name, you can also use the node name.

For example: https://brn123456abcdef

- The NetBIOS name can be found in the Network Configuration Report.

3. If your connection is not private, click the **Advanced** button, and then continue to the web page.

4. If required, type the password in the **Login** field, and then click **Login**.



The default password to manage this machine's settings is located on the bottom of the machine and marked "**Pwd:**". Change the default password by following the on-screen instructions when you first log in. If the Battery Base is installed, uninstall it to confirm the default password.

5. In the left navigation bar, click **Network > Security > Certificate**.



If the left navigation bar is not visible, start navigating from ☰.

6. Click **Export**.

7. To encrypt the output file, type a password in the **Enter password** field. If the **Enter password** field is blank, your output file will not be encrypted.

8. Type the password again in the **Retype password** field, and then click **Submit**.

9. Click the downloaded file to open it.

10. When the **Certificate Import Wizard** appears, click **Next**.

11. Click **Next**.

12. If required, type a password, and then click **Next**.

13. Select **Place all certificates in the following store**, and then click **Browse....**

14. Select the **Trusted Root Certification Authorities**, and then click **OK**.

15. Click **Next**.

16. Click **Finish**.

17. Click **Yes**, if the fingerprint (thumbprint) is correct.

18. Click **OK**.



Related Information

- [Manage Your Network Machine Securely Using SSL/TLS](#)
-

Print Documents Securely Using SSL/TLS

Related Models: TD-2320D/TD-2350D/TD-2320DF/TD-2350DF/TD-2320DSA/TD-2350DSA

- [Print Documents Using IPPS](#)

Print Documents Using IPPS

Related Models: TD-2320D/TD-2350D/TD-2320DF/TD-2350DF/TD-2320DSA/TD-2350DSA

To print documents securely with IPP protocol, use the IPPS protocol.

1. Start your web browser.
2. Type "https://machine's IP address" in your browser's address bar (where "machine's IP address" is your machine's IP address).

For example:

https://192.168.1.2



- If you are using a Domain Name System or enable a NetBIOS name, you can type another name, such as "SharedPrinter" instead of the IP address.

For example: https://SharedPrinter

- If you enable a NetBIOS name, you can also use the node name.

For example: https://brn123456abcdef

- The NetBIOS name can be found in the Network Configuration Report.

3. If required, type the password in the **Login** field, and then click **Login**.



The default password to manage this machine's settings is located on the bottom of the machine and marked "**Pwd:**". Change the default password by following the on-screen instructions when you first log in. If the Battery Base is installed, uninstall it to confirm the default password.

4. In the left navigation bar, click **Network > Network > Protocol**.



If the left navigation bar is not visible, start navigating from ☰.

5. Make sure the **IPP** checkbox is selected.



If the **IPP** checkbox is not selected, select the **IPP** checkbox, and then click **Submit**.

Restart your machine to activate the configuration.

After the machine restarts, return to the machine's web page, type the password, and then in the left navigation bar, click **Network > Network > Protocol**.

6. Click **HTTP Server Settings**.
7. Select the **HTTPS(Port 443)** checkbox in the **IPP** area, and then click **Submit**.
8. Restart your machine to activate the configuration.

Communication using IPPS cannot prevent unauthorised access to the print server.



Related Information

- [Print Documents Securely Using SSL/TLS](#)

Use SNMPv3

Related Models: TD-2320D/TD-2350D/TD-2320DF/TD-2350DF/TD-2320DSA/TD-2350DSA

- [Manage Your Network Machine Securely Using SNMPv3](#)

Manage Your Network Machine Securely Using SNMPv3

Related Models: TD-2320D/TD-2350D/TD-2320DF/TD-2350DF/TD-2320DSA/TD-2350DSA

The Simple Network Management Protocol version 3 (SNMPv3) provides user authentication and data encryption to manage network devices securely.

1. Start your web browser.
2. Type "https://Common Name" in your browser's address bar (where "Common Name" is the Common Name that you assigned to the certificate; this could be your IP address, node name, or domain name).
3. If required, type the password in the **Login** field, and then click **Login**.



The default password to manage this machine's settings is located on the bottom of the machine and marked "**Pwd:**". Change the default password by following the on-screen instructions when you first log in. If the Battery Base is installed, uninstall it to confirm the default password.

4. In the left navigation bar, click **Network > Network > Protocol**.



If the left navigation bar is not visible, start navigating from ☰.

5. Make sure the **SNMP** setting is enabled, and then click **Advanced Settings**.
6. Configure the SNMPv1/v2c mode settings.

Option	Description
SNMP v1/v2c read-write access	The print server uses version 1 and version 2c of the SNMP protocol. You can use all of your machine's applications in this mode. However, it is not secure since it will not authenticate the user and data will not be encrypted.
SNMPv1/v2c read-only access	The print server uses the read-only access of version 1 and version 2c of the SNMP protocol.
Disabled	Disable version 1 and version 2c of the SNMP protocol. All applications that use SNMPv1/v2c will be restricted. To allow the use of SNMPv1/v2c applications, use the SNMPv1/v2c read-only access or SNMP v1/v2c read-write access mode.

7. Configure the SNMPv3 mode settings.

Option	Description
Enabled	The print server uses version 3 of the SNMP protocol. To manage the print server securely, use the SNMPv3 mode.
Disabled	Disable version 3 of the SNMP protocol. All applications that use SNMPv3 will be restricted. To allow the use of SNMPv3 applications, use the SNMPv3 mode.

8. Click **Submit**.



If your machine displays the protocol setting options, select the options you want.

9. Restart your machine to activate the configuration.



Related Information

- [Use SNMPv3](#)

Use IEEE 802.1x Authentication for Your Network

Related Models: TD-2320D/TD-2350D/TD-2320DF/TD-2350DF/TD-2320DSA/TD-2350DSA

- [What Is IEEE 802.1x Authentication?](#)
- [Configure IEEE 802.1x Authentication Using Web Based Management \(Web Browser\)](#)
- [IEEE 802.1x Authentication Methods](#)

What Is IEEE 802.1x Authentication?

Related Models: TD-2320D/TD-2350D/TD-2320DF/TD-2350DF/TD-2320DSA/TD-2350DSA

IEEE 802.1x is an IEEE standard that limits access from unauthorised network devices. Your Brother machine sends an authentication request to a RADIUS server (Authentication server) through your access point or hub. After your request has been verified by the RADIUS server, your machine can access the network.



Related Information

- [Use IEEE 802.1x Authentication for Your Network](#)
-

Configure IEEE 802.1x Authentication Using Web Based Management (Web Browser)

Related Models: TD-2320D/TD-2350D/TD-2320DF/TD-2350DF/TD-2320DSA/TD-2350DSA

- If you configure your machine using EAP-TLS authentication, you must install the client certificate issued by a CA before you start configuration. Contact your network administrator about the client certificate. If you have installed more than one certificate, we recommend writing down the certificate name you want to use.
- Before you verify the server certificate, you must import the CA certificate issued by the CA that signed the server certificate. Contact your network administrator or your Internet Service Provider (ISP) to confirm whether a CA certificate import is necessary.

1. Start your web browser.
2. Type "https://machine's IP address" in your browser's address bar (where "machine's IP address" is your machine's IP address).

For example:

https://192.168.1.2



- If you are using a Domain Name System or enable a NetBIOS name, you can type another name, such as "SharedPrinter" instead of the IP address.

For example: https://SharedPrinter

- If you enable a NetBIOS name, you can also use the node name.

For example: https://brn123456abcdef

- The NetBIOS name can be found in the Network Configuration Report.

3. If required, type the password in the **Login** field, and then click **Login**.



The default password to manage this machine's settings is located on the bottom of the machine and marked "**Pwd:**". Change the default password by following the on-screen instructions when you first log in. If the Battery Base is installed, uninstall it to confirm the default password.

4. In the left navigation bar, click **Network**.



If the left navigation bar is not visible, start navigating from ☰.

5. Do one of the following:

- For the wired network
Click **Wired** > **Wired 802.1x Authentication**.
- For the wireless network
Click **Wireless** > **Wireless (Enterprise)**.

6. Configure the IEEE 802.1x authentication settings.



- To enable IEEE 802.1x authentication for wired networks, select **Enabled** for **Wired 802.1x status** on the **Wired 802.1x Authentication** page.
- If you are using **EAP-TLS** authentication, you must select the client certificate installed (shown with certificate name) for verification from the **Client Certificate** drop-down list.
- If you select **EAP-FAST**, **PEAP**, **EAP-TTLS**, or **EAP-TLS** authentication, select the verification method from the **Server Certificate Verification** drop-down list. Verify the server certificate using the CA certificate, imported to the machine in advance, issued by the CA that signed the server certificate.

Select one of the following verification methods from the **Server Certificate Verification** drop-down list:

Option	Description
No Verification	The server certificate can always be trusted. The verification is not performed.
CA Cert.	The verification method to check the CA reliability of the server certificate, using the CA certificate issued by the CA that signed the server certificate.
CA Cert. + ServerID	The verification method to check the common name ¹ value of the server certificate, in addition to the CA reliability of the server certificate.

7. When finished with configuration, click **Submit**.

For wired networks: After configuring, connect your machine to the IEEE 802.1x supported network. After a few minutes, print the Network Configuration Report to check the <**Wired IEEE 802.1x**> status.

Option	Description
Success	The wired IEEE 802.1x function is enabled and the authentication was successful.
Failed	The wired IEEE 802.1x function is enabled; however, the authentication failed.
Off	The wired IEEE 802.1x function is not available.



Related Information

- [Use IEEE 802.1x Authentication for Your Network](#)

¹ The common name verification compares the common name of the server certificate to the character string configured for the **Server ID**. Before you use this method, contact your system administrator about the server certificate's common name and then configure **Server ID**.

IEEE 802.1x Authentication Methods

Related Models: TD-2320D/TD-2350D/TD-2320DF/TD-2350DF/TD-2320DSA/TD-2350DSA

EAP-FAST

Extensible Authentication Protocol-Flexible Authentication via Secured Tunneling (EAP-FAST) has been developed by Cisco Systems, Inc., which uses a user ID and password for authentication, and symmetric key algorithms to achieve a tunnelled authentication process.

Your Brother machine supports the following inner authentication methods:

- EAP-FAST/NONE
- EAP-FAST/MS-CHAPv2
- EAP-FAST/GTC

EAP-MD5 (Wired network)

Extensible Authentication Protocol-Message Digest Algorithm 5 (EAP-MD5) uses a user ID and password for challenge-response authentication.

PEAP

Protected Extensible Authentication Protocol (PEAP) is a version of EAP method developed by Cisco Systems, Inc., Microsoft Corporation and RSA Security. PEAP creates an encrypted Secure Sockets Layer (SSL)/Transport Layer Security (TLS) tunnel between a client and an authentication server, for sending a user ID and password. PEAP provides mutual authentication between the server and the client.

Your Brother machine supports the following inner authentication methods:

- PEAP/MS-CHAPv2
- PEAP/GTC

EAP-TTLS

Extensible Authentication Protocol-Tunneled Transport Layer Security (EAP-TTLS) has been developed by Funk Software and Certicom. EAP-TTLS creates a similar encrypted SSL tunnel to PEAP, between a client and an authentication server, for sending a user ID and password. EAP-TTLS provides mutual authentication between the server and the client.

Your Brother machine supports the following inner authentication methods:

- EAP-TTLS/CHAP
- EAP-TTLS/MS-CHAP
- EAP-TTLS/MS-CHAPv2
- EAP-TTLS/PAP

EAP-TLS

Extensible Authentication Protocol-Transport Layer Security (EAP-TLS) requires digital certificate authentication both at a client and an authentication server.



Related Information

- [Use IEEE 802.1x Authentication for Your Network](#)

Update

- [Update P-touch Editor](#)
- [Update the Firmware](#)

Update P-touch Editor

Before updating P-touch Editor, install the printer driver.

1. Start P-touch Editor .

Click **Start > Brother P-touch > P-touch Editor**, or double-click the **P-touch Editor** icon on the desktop.

NOTE

Depending on your computer's operating system, the Brother P-touch folder may or may not be created.

2. Click the **New Layout** button to open the main window.
3. Click **Help > Check for Updates**.
4. If the update is available, a confirmation message will appear. Click **Download**.



Related Information

- [Update](#)

Update the Firmware

- Do not turn the power off when transferring data or updating firmware.
- If any other application is running, exit the application.

Before updating the firmware, you must first install the printer driver.

1. Turn the printer on and connect the USB cable.
2. Start the P-touch Update Software.
Click **Start > Brother P-touch > P-touch Update Software**, or double-click the **P-touch Update Software** icon on the desktop.
3. Click the **Firmware update** icon.
4. Select the **Printer** option, make sure the machine is connected correctly, and then click **OK**.
5. Select **Language** from the drop-down list.
6. Select the checkbox next to the firmware you want to update, and then click **Transfer**.

NOTE

Do not turn the printer off or disconnect the cable during the update process and data transfer.

7. Check the content to be updated, and then click **Start** to begin the update.
The firmware update begins.



Related Information

- [Update](#)

Printer Settings

In addition to the following methods, you can use the BRConfiguration Tool to configure your printer. For more information on the BRConfiguration Tool, go to your model's **Manuals** page on the Brother support website at support.brother.com.

- [Change Printer Settings Using the Printer Setting Tool \(Windows\)](#)
- [Apply Setting Changes to Multiple Printers \(Windows\)](#)
- [Change Printer Settings Using Web Based Management](#)
- [Confirm Printer Settings](#)
- [Details of Printer Settings Report](#)
- [Print and Confirm Dump Data](#)
- [Change Printer Settings Using the Printer](#)

Change Printer Settings Using the Printer Setting Tool (Windows)

- Make sure the printer driver has been installed correctly and you can print.
- Connect the printer to a computer with a USB cable.



The Printer Setting Tool is installed in addition to the printer driver and other software when using the installer.

1. Connect the printer you want to configure to the computer.
2. Start the Printer Setting Tool.

Click **Start > Brother > Printer Setting Tool**.

The main window appears.

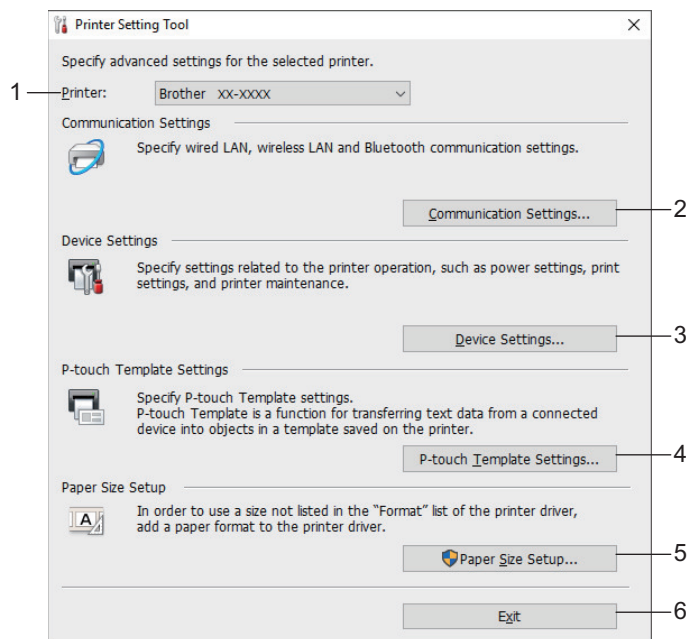

- 1. Printer**
Lists the connected printers.
- 2. Communication Settings (TD-2320D/TD-2350D/TD-2320DF/TD-2350DF/TD-2320DSA/TD-2350DSA)**
Specify communication settings.
- 3. Device Settings**
Specify device settings.
- 4. P-touch Template Settings**
Specify P-touch Template settings.
For more information, see the *P-touch Template Manual/Command Reference* (English only). You can download the latest version from the Brother support website at support.brother.com/manuals.
- 5. Paper Size Setup**
If the paper size you want is not listed in the **Paper Size** list, you must add the media information and settings to the printer driver.

NOTE

To access **Paper Size Setup** settings, you must be logged on with administrator rights.

- 6. Exit**
Click to close the window.

-
3. Make sure the printer you want to configure appears next to **Printer**.
If a different printer appears, select the printer you want from the drop-down list.
 4. Select the settings you want to change, and then specify or change the settings in the dialog box.
 5. Click **Apply** to apply the settings to the printer.
 6. Click **Exit** in the main window to finish specifying settings.



Use the Printer Setting Tool to configure the printer only when the printer is idle. The printer may malfunction if you try to configure it while it is processing or printing a print job.



Related Information

- [Printer Settings](#)
 - [Printer Setting Tool: Communication Settings \(Windows\)](#)
 - [Printer Setting Tool \(Windows\): Device Settings](#)
 - [Printer Setting Tool \(Windows\): P-touch Template Settings](#)
 - [Printer Setting Tool \(Windows\): Paper Size Setup](#)
-

Printer Setting Tool: Communication Settings (Windows)

Related Models: TD-2320D/TD-2350D/TD-2320DF/TD-2350DF/TD-2320DSA/TD-2350DSA

TD-2350D/TD-2350DF/TD-2350DSA: Use Communication Settings in the Printer Setting Tool to specify or change the printer communication method, when connecting the printer and computer with a USB cable or via a Bluetooth connection.

TD-2320D/TD-2320DF/TD-2320DSA: Use Communication Settings in the Printer Setting Tool to specify or change the printer communication method, when connecting the printer and computer with a USB cable.

You can change one printer's communication settings for one printer, and then apply these settings to multiple printers.

>> [Settings Dialog Box](#)

>> [Menu Bar](#)

>> [General Tab](#)

>> [Wired LAN/Wireless LAN Tabs \(TD-2320D/TD-2350D/TD-2320DF/TD-2350DF/TD-2320DSA/TD-2350DSA\)](#)

>> [Wireless Direct Tab \(TD-2350D/TD-2350DF/TD-2350DSA\)](#)

>> [Bluetooth Tab \(TD-2350D/TD-2350DF/TD-2350DSA\)](#)

Settings Dialog Box

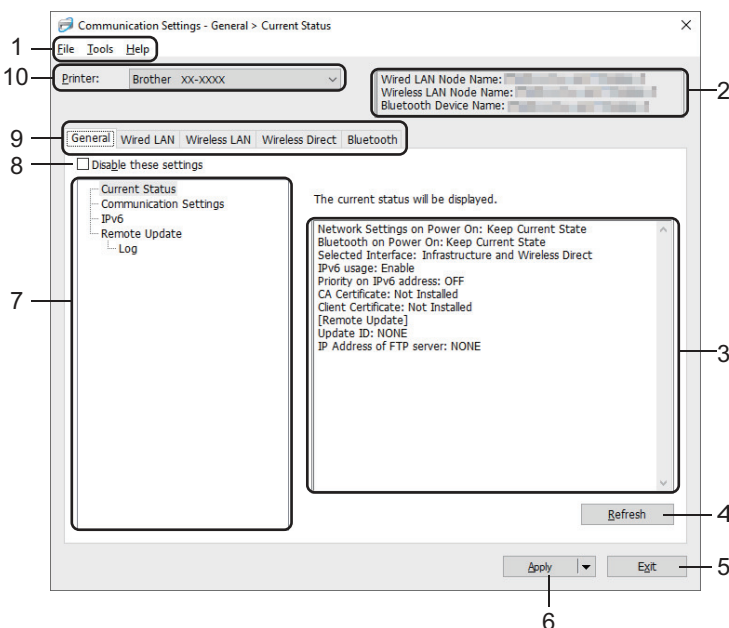

1. Menu Bar

Provides access to various commands grouped under each menu title (the **File**, **Tools**, and **Help** menus) according to their functions.

2. Device Name

Displays the device name.

3. Settings Display/Change Area

Displays the current settings for the selected item.

4. Refresh

Click to update the displayed settings with the most recent information.

5. Exit

Click to exit the **Communication Settings** window and return to the main window of the Printer Setting Tool.



Settings are not applied to printers if **Exit** is clicked without clicking the **Apply** button after changing the settings.

6. Apply

Click to apply the settings to the printer. To save the specified settings in a command file, select the **Save in Command File** command from the drop-down list. The saved command file can be used with the Mass Storage Mode to apply the settings to a printer.





Clicking the **Apply** button applies all settings in all tabs to the printer. If the **Disable these settings** checkbox is selected, the settings are not applied.

7. Items

When the **Current Status** menu is selected, the current settings appear in the settings display/change area. Select the item for the settings you want to change.

8. Disable these settings

When this checkbox is selected,  appears in the tab, and the settings can no longer be specified or changed. Settings in a tab where  appears are not applied to the printer even if the **Apply** button is clicked. In addition, the settings in the tabs are not saved or exported when the **Save in Command File** or **Export** command is used. To apply the settings to the printer, or to save or export them, make sure you clear the checkbox.

9. Settings Tabs

Contains settings that may be specified or changed. If  appears in the tab, the settings are not applied to the printer.

10. Printer

Lists the connected printers.

Menu Bar

File Menu Options

Apply Settings to the Printer

Apply the settings to the printer.

Save Settings in Command File

Save the specified settings in a command file. The file extension is BIN. The saved command file can be used with the Mass Storage Mode to apply the settings to a printer.



-
- If the **Disable these settings** checkbox is selected, the settings are not saved.
 - The following information is not saved with the command file:
 - Node name
 - IP address, subnet mask, and default gateway (when the IP address is set to **STATIC**)
 - The saved communication settings commands are intended to be used only for applying settings to a printer. To apply the settings to the printer using this command file, use the Mass Storage Mode.
 - Saved command files contain authentication keys and passwords. Take necessary measures to protect saved command files, such as saving them in a location that cannot be accessed by other users.
 - Do not send command files to a different printer model.
-

Install Certificates

Some network authentication methods may require a certificate.

Install a certificate on the connected printer or save a certificate as a command file that can be distributed to the same printer models.

Import

Import from the current computer wireless settings (TD-2350D/TD-2350DF/TD-2350DSA)

Imports the settings from the computer.



- When importing the computer's wireless settings, administrator privileges for the computer are required.
- Only personal security authentication settings (open system, public key authentication, WPA/WPA2-PSK, and WPA3 SAE up to 63 characters) can be imported. Enterprise security authentication (such as EAP-FAST), WPA2-PSK (TKIP) and WPA-PSK (AES) settings cannot be imported.
- If multiple wireless LANs are enabled for the computer you use, the first detected wireless settings (only personal settings) are considered for the import data.
- Only the settings from the **Wireless LAN** tab - **Wireless Settings** pane can be imported (communication mode, SSID, authentication method, encryption mode and authentication key).

Select a Profile to import

Imports the exported file and applies the settings to a printer. Click **Browse** and select the file you want to import. The settings in the selected file appear in the settings display/change area.



- All settings can be imported, except for node names.
- Only the profiles compatible with the selected printer can be imported.
- If the imported profile's IP address is set to **STATIC**, change the IP address of the imported profile, if needed, so that it does not duplicate the IP address of an existing configured printer on the network.

Export

Save the current settings in a file. If the **Disable these settings** checkbox is selected, the settings are not saved.



Exported files are not encrypted.

Tools Menu Options

Option Settings

Automatically restart the printer after applying new settings

If this checkbox is selected, the printer automatically restarts after communication settings are applied. If this checkbox is cleared, you must restart the printer manually.



When configuring multiple printers, you can reduce the time needed to change the settings by clearing this checkbox. In this case, we recommend selecting this checkbox when configuring the first printer so that you can confirm that each setting is working as intended.

Automatically detects the connected printer, and retrieves the current settings

If this checkbox is selected, and the printer is connected to the computer, the printer is automatically detected and the printer's current settings are displayed in the **Current Status** pane.



If the connected printer is different from the printer shown in the **Printer** drop-down list, the settings available on all tabs change to match the connected printer.

Change Node Name/Bluetooth Device Name

Allows renaming a node name and Bluetooth device name.

Reset to Default Communication Settings

Reset the communication settings to their factory settings.

Help Menu Options

Display Help

Displays the Help topics.

General Tab

Communication Settings

Network Settings on Power On

Specify the conditions for connecting via network when the printer is turned on.

Selected Interface (TD-2350D/TD-2350DF/TD-2350DSA)

Select the **Infrastructure**, **Infrastructure and Wireless Direct**, or **Wireless Direct** option.

Bluetooth on Power On (TD-2350D/TD-2350DF/TD-2350DSA)

Specify the conditions for connecting via Bluetooth when the printer is turned on. Select the **On by Default**, **Off by Default**, or **Keep Current State** option.

Remote Update (TD-2350D/TD-2350DF/TD-2320DSA/TD-2350DSA)

IP Address of FTP server

Type the FTP server address.

Port

Specify the port number used to access the FTP server.

User name

Type a user name that has permission to log in to the FTP server.

Password

Type the password associated with the user name you entered in the **User name** field.

Path

Type the path to the folder on the FTP server where you want to download the update file from.

Setting file name

Specify the update file name on the FTP server.

Log

Log storage

Select whether to export the update log to the FTP server.

Log storage path of FTP server

Type the path to the folder on the FTP server where you want to export the log data.

AirPrint Settings

Enable or disable AirPrint, and configure the settings.

Wired LAN/Wireless LAN Tabs (TD-2320D/TD-2350D/TD-2320DF/TD-2350DF/TD-2320DSA/TD-2350DSA)

TCP/IP (Wireless)

Boot Method

Select the **AUTO**, **BOOTP**, **DHCP**, **RARP**, or **STATIC** option.

IP Address/Subnet Mask/Gateway

Specify the various networking values. You can enter these settings only when the IP address is set to **STATIC**.

DNS Server Method

Select the **AUTO** or **STATIC** option.

Primary DNS Server IP Address/Secondary DNS Server IP Address

You can enter these settings only when the DNS server is set to **STATIC**.

IPv6

Static IPv6 Address

Specify a permanent IPv6 address.

Enable this address

Enables the specified static IPv6 address.

Primary DNS Server IPv6 Address/Secondary DNS Server IPv6 Address

Specify the DNS server IPv6 addresses.

IPv6 Address List

Displays the list of IPv6 addresses.

Wired 802.1x Authentication

Configures IEEE 802.1x authentication.

Wired 802.1x Status

Enable or disable IEEE 802.1x authentication for wired network.

Authentication Method

Select the authentication method.

User ID/Password

You can specify settings only when EAP-MD5, EAP-FAST, PEAP, EAP-TTLS, or EAP-TLS is selected as the authentication method. In addition, with EAP-TLS, it is not necessary to register a password, but a client certificate must be registered. To register a certificate, connect to the printer from a web browser, and then select the certificate. Installation of the authentication certificate can also be performed with the Printer Setting Tool by going to the menu bar: **File > Install Certificates**.

Display the key and password on-screen

If this checkbox is selected, keys and passwords are displayed in plain (non-encrypted) text.

Wireless Settings (TD-2350D/TD-2350DF/TD-2350DSA)

Communication Mode

Displays communication mode.

SSID(Network Name)

Clicking **Search** displays the available SSIDs in a separate dialog box.

Channel

Displays the automatically selected channel.

Authentication Method/Encryption Mode

The supported encryption modes for the authentication methods are shown in the table below.

Authentication Method	Encryption Mode
Open System	None / WEP
Shared Key	WEP
WPA3-SAE	AES
WPA/WPA2-PSK/WPA3-SAE	TKIP+AES / AES
EAP-FAST/NONE	TKIP+AES / AES

Authentication Method	Encryption Mode
EAP-FAST/MS-CHAPv2	TKIP+AES / AES
EAP-FAST/GTC	TKIP+AES / AES
PEAP/MS-CHAPv2	TKIP+AES / AES
PEAP/GTC	TKIP+AES / AES
EAP-TTLS/CHAP	TKIP+AES / AES
EAP-TTLS/MS-CHAP	TKIP+AES / AES
EAP-TTLS/MS-CHAPv2	TKIP+AES / AES
EAP-TTLS/PAP	TKIP+AES / AES
EAP-TLS	TKIP+AES / AES



To specify higher level security settings: When performing certificate verification with EAP-FAST, PEAP, EAP-TTLS, or EAP-TLS authentication methods, the certificate cannot be specified from the Printer Setting Tool. After the printer is configured to connect to the network, specify the certificate by accessing the printer from a web browser. Installation of the authentication certificate can also be performed with the Printer Setting Tool by going to the Menu Bar, and clicking **File > Install Certificates**.

WEP Key

You can specify a setting only when WEP is selected as the encryption mode.

Passphrase

You can specify a setting only when WPA/WPA2-PSK/WPA3-SAE is selected as the authentication method.

User ID/Password

You can specify settings only when EAP-FAST, PEAP, EAP-TTLS, or EAP-TLS is selected as the authentication method. In addition, with EAP-TLS, it is not necessary to register a password, but a client certificate must be registered. To register a certificate, connect to the printer from a web browser, and then specify the certificate.

Display the key and password on-screen

If this checkbox is selected, keys and passwords are displayed in plain (non-encrypted) text.

Wireless Direct Tab (TD-2350D/TD-2350DF/TD-2350DSA)

Wireless Direct Settings

SSID/Network Key Generation

Select the **AUTO** or **STATIC** option.

SSID(Network Name)/Network Key

Specify the SSID (25 ASCII characters or fewer) and the network key (63 characters or fewer) you want to use in the Wireless Direct mode.



The default SSID and password are as follows:

- SSID: "DIRECT-(serial number's last 5 digits)_TD-2350####"
- Password: *****

where ***** is the eight-digit Wireless Direct password indicated on the label on the bottom or inside the printer.

Channel

Specify the channel to use for the Wireless Direct mode.

Bluetooth Tab (TD-2350D/TD-2350DF/TD-2350DSA)

Bluetooth Settings

Bluetooth Mode

Select the control mode when Bluetooth is enabled.

Classic

Visible to Other Devices

Allows the printer to be discovered by other Bluetooth devices.

Change PIN code

Changes the PIN.

Display the PIN code on-screen

Displays the PIN on your computer.

Pairing requires user confirmation on printer

If this checkbox is selected when using Classic Bluetooth mode, it is necessary to perform additional printer button operations when pairing with devices running Bluetooth 2.1 or later.

Auto re-pairing

Sets whether to automatically reconnect to a previously connected Apple device (iPad, iPhone or iPod touch).

Low Energy

Minimum Security Mode

Select the minimum security level when using the **Low Energy Only** mode.

Pairing requires user confirmation on printer

If this checkbox is selected when using the **Low Energy Only** mode, it is necessary to perform additional printer button operations when pairing with Low Energy compatible devices.



Related Information

- [Change Printer Settings Using the Printer Setting Tool \(Windows\)](#)

Printer Setting Tool (Windows): Device Settings

TD-2350D/TD-2350DF/TD-2350DSA: Use **Device Settings** in the Printer Setting Tool to specify or change printer settings when connecting the printer and computer with a USB cable or via a Bluetooth connection.

TD-2310D/TD-2320D/TD-2320DF/TD-2320DSA: Use **Device Settings** in the Printer Setting Tool to specify or change printer settings when connecting the printer and computer with a USB cable.

You can change one printer's device settings for one printer, and then apply these settings to multiple printers. When printing from a computer application, various printing settings can be specified from the printer driver; however, using the Device Settings tool in the Printer Setting Tool, more advanced settings can be specified. When you open the **Device Settings** window, the printer's current settings are retrieved and displayed. If the current settings cannot be retrieved, the previous settings are displayed. If the current settings cannot be retrieved and previous settings were not specified, the machine's factory settings appear.

>> [Settings Dialog Box](#)

>> [Menu Bar](#)

>> [Basic Tab](#)

>> [Advanced Tab](#)

>> [Print Position / Sensors Tab](#)

>> [Display Settings Tab \(TD-2320D/TD-2350D/TD-2320DF/TD-2350DF/TD-2320DSA/TD-2350DSA\)](#)

>> [Management Tab](#)

Settings Dialog Box

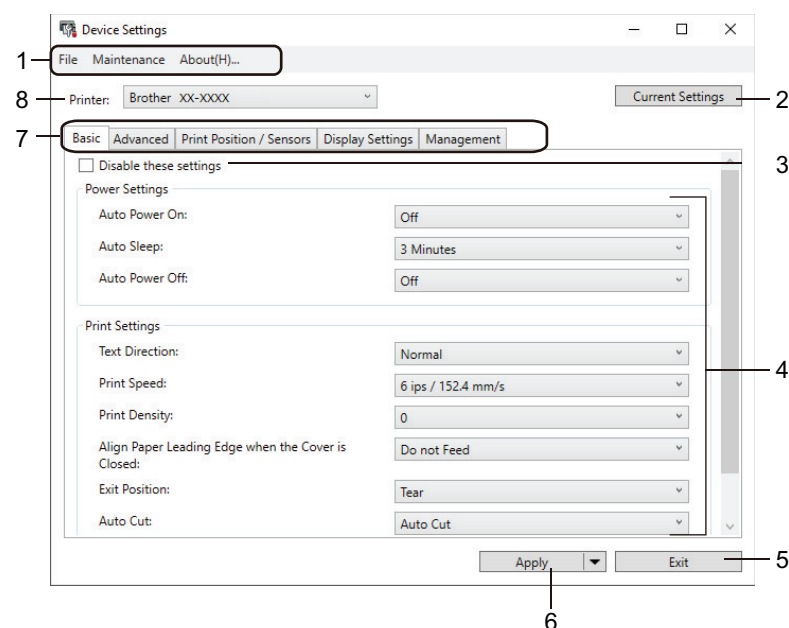



1. Menu Bar

Provides access to various commands grouped under each menu title (the **File**, **Maintenance**, and **About** menus) according to their functions.

2. Current Settings

Retrieves the settings from the currently connected printer and displays them in the dialog box. Settings can also be retrieved for the parameters on tabs with .

3. Disable these settings

When this checkbox is selected,  appears on the tab, and the settings can no longer be specified or changed. Settings in a tab where  appears are not applied to the printer even if **Apply** is clicked. In addition, the settings in the tab are not saved or exported when you use the **Save in Command File** or **Export** command.

4. Parameters

Displays the current settings.

5. Exit

Exits the **Device Settings** window and returns to the main window of the Printer Setting Tool.

6. Apply

Applies the settings to the printer. To save the specified settings in a command file, select the **Save in Command File** command from the drop-down list.

The saved command file can be used with the Mass Storage Mode to apply the settings to a printer.

7. Settings Tabs

Contains settings that may be specified or changed.



If  appears in the tab, the settings cannot be changed. In addition, the settings in the tab are not applied to the printer even if you click **Apply**. The settings in the tab are not saved or exported when you use the **Save in Command File** or **Export** commands.

8. Printer

Specifies the printer you want to configure.

Menu Bar

File Menu Options

- **Apply Settings to the Printer**

Applies the settings to the printer.

- **Check Setting**

Displays the current settings.

- **Save Settings in Command File**

Saves the specified settings in a command file.

- **Import**

Imports an exported file.

- **Export**

Saves the current settings in a file.

- **Exit**

Exits the **Device Settings** window and returns to the main window of the Printer Setting Tool.

Maintenance Menu Options



You must have administrator privileges for the computer or the printer to display some items. Check if you have administrator privileges for the printer by clicking the **Printer properties** menu, and then clicking the **Security** tab.

- **Save Print Log in File**

Saves the print log in a file in the CSV format.

- **Print Unit Settings**

Prints a report containing the current firmware version and device setting information.



When you print this report, we recommend using a 58 mm or wider media.

- **Check Printer Information**

Checks the status of the printer.

- **Switch to Dump Mode**

Transfers to the Dump Mode to print and confirm received print data without interpretation of the print command.

- **Check Print Head Status**

Checks if there are no problems with the Print Head.

- **Reset to Factory Defaults**

TD-2310D: Resets all the settings to the factory settings, including device settings, and transferred data.

TD-2320D/TD-2350D/TD-2320DF/TD-2350DF/TD-2320DSA/TD-2350DSA: Resets all the settings to the factory settings, including device settings, transferred data, and network settings.

- **Reset only Device Settings**

Resets the settings that can be changed in the Device Settings to the factory settings.

- **Delete Template and Database**

Deletes the templates and databases stored in the printer.

- **Delete Print Log**

Deletes the print log stored in the printer.

- **Option Settings**

If the **Do not display an error message if the current settings cannot be retrieved at startup** checkbox is selected, a message is not displayed the next time.

Basic Tab

- **Auto Power On**

Specifies whether the printer turns on automatically when the AC Power Cord is plugged into an electrical socket.

- **Auto Sleep**

Specifies the amount of time to pass before the printer automatically goes into sleep mode.



- The printer will automatically enter sleep mode when the specified time elapses under the following conditions:

- The printer does not receive data.
- A LAN cable is not connected. (TD-2320D/TD-2350D/TD-2320DF/TD-2350DF/TD-2320DSA/TD-2350DSA)
- In idle mode. (TD-2310D/TD-2320D/TD-2320DF)
- In idle mode or template selection mode. (TD-2350D/TD-2350DF/TD-2320DSA/TD-2350DSA)
- When no device is connected to the USB port. (TD-2320D/TD-2350D/TD-2320DF/TD-2350DF/TD-2320DSA/TD-2350DSA)
- When not communicating using the serial port.

- Sleep mode is cancelled when the following operations are performed:

- A printer button is pressed.
- The Roll Compartment Cover is opened or closed.
- The printer receives data. Except when receiving data via a serial port.
- The printer receives data.
- The USB cable is disconnected and then reconnected.

- **Auto Power Off**

Specifies the period of time that passes before the printer turns off automatically when connected to an electrical socket.



-
- The printer will automatically enter power off mode when the specified time elapses under the following conditions:
 - The printer does not receive data.
 - A LAN cable is not connected. (TD-2320D/TD-2350D/TD-2320DF/TD-2350DF/TD-2320DSA/TD-2350DSA)
 - In idle mode. (TD-2310D/TD-2320D/TD-2320DF)
 - In idle mode or template selection mode. (TD-2350D/TD-2350DF/TD-2320DSA/TD-2350DSA)
 - When no device is connected to the USB port. (TD-2320D/TD-2350D/TD-2320DF/TD-2350DF/TD-2320DSA/TD-2350DSA)
 - When not communicating using the serial port.
 - Power off mode is cancelled when the following operations are performed:
 - A printer button is pressed.
 - The Roll Compartment Cover is opened or closed.
 - The printer receives data. Except when receiving data via a serial port.
 - The printer receives data.
 - The USB cable is disconnected and then reconnected.
-

- **Battery Charge Level** (TD-2320D/TD-2350D/TD-2320DF/TD-2350DF/TD-2320DSA/TD-2350DSA)
Specifies the maximum charge level.
-



To get the longest life from the rechargeable Li-ion battery, select **80 %**. Although the number of print jobs that can be printed on a single charge will be less when you select **80 %**, you can get a longer overall rechargeable Li-ion battery life.



- **Text Direction**
Selects the printing orientation.
 - **Print Speed**
Selects the printer's printing speed.
-



- If you increase the print speed, the print result may become lighter.
 - If the barcode on the printed label is difficult to read, select a slower printing speed.
-

- **Print Density**
Adjusts the printer's printing density.
Changing the **Energy Rank** setting in the **Paper Size Setup** can further increase the print density. For more information, see *Related Topics: Printer Setting Tool (Windows): Paper Size Setup*.
 - **Align Paper Leading Edge when the Cover is Closed**
Selects whether the paper is automatically fed when the cover is closed.
 - **Exit Position** (TD-2310D/TD-2320D/TD-2350D/TD-2320DSA/TD-2350DSA)
Selects the media output location.
 - **Auto Cut** (TD-2320D/TD-2350D/TD-2320DSA/TD-2350DSA)
Sets the cutting method when printing multiple labels.
-

Advanced Tab

- **Feed Key Function**
Selects the operation performed when  is pressed. If **Program Settings** is selected, click **File** and select the command file.
- **Function Key Function** (TD-2310D/TD-2320D/TD-2320DF)
Selects the operation performed when  is pressed. If **Program Settings** is selected, click **File** and select the command file.

If the Cutter is attached, manual cutting can be set using the Function Key.

- **Print Information Report**

Selects the information you want to include in the printer Information Report.

- **Beeper** (TD-2320DSA/TD-2350DSA)

Selects the beeper volume.

- **JPEG Printing Setting**

Selects the method of image processing when printing JPEG images.

- **Serialize Mode**

Specifies the serialise (number) method for your printed labels.

- **Save Printer Print Log**

Selects whether to save the printer's print log. If **Disable** is selected, the **Save Print Log in File** option cannot be enabled.

- **Print Data after Printing**

Specifies whether print data is erased after printing.

Print Position / Sensors Tab

When you use standard media, it is unnecessary to adjust the sensors.

- **Printing Reference Point Adjustment**

Adjusts the position of the reference point (point of origin for printing). This corrects printing misalignments resulting from differences in printer models or from the fixed margins of some software.

The reference point cannot be adjusted for raster printing.

- **Tear Adjust** (TD-2310D/TD-2320D/TD-2350D/TD-2320DSA/TD-2350DSA)

- Adjusts the Tear Bar tear-off position for paper media.

NOTE

Depending on the media type, the cut position and margins may not match your settings. If this occurs, adjust the Tear Adjust setting, and then try to print again.

- When the **Use Peeler Function** or Auto Cutter Function in the printer driver is enabled and the peeled labels are jammed or are not ejected correctly after printing, adjust the Tear Adjust setting, and then try to print again.

- **Media Sensor (Transmissive/Gap)**

- **Detection Sensitivity**

Adjusts the sensitivity of gap (spacing) detection for die-cut labels.

- **Luminescence Adjustment**

Adjusts the amount of light emitted by the transmissive/gap sensor.

- **Media Sensor (Reflective/Bar)**

- **Mark Detection Sensitivity**

Adjusts the sensitivity of black mark detection.

- **Luminescence Adjustment**

Adjusts the amount of light emitted by the reflective/black mark sensor.

- **Media Sensor (Peeler/Linerless cutter)** (TD-2320D/TD-2350D/TD-2320DF/TD-2350DF/TD-2320DSA/TD-2350DSA)

Specifies the settings when the Label Peeler (optional) is used.

- **Detection Sensitivity**

Adjusts the precision of the sensor that detects whether the label has been peeled.

Display Settings Tab (TD-2320D/TD-2350D/TD-2320DF/TD-2350DF/TD-2320DSA/TD-2350DSA)

- **Clock**
Sets the clock function.
- **Synchronize with SNTP server**
Synchronises time with the SNTP server.
- **Time Zone**
Sets the time zone.
- **Set Clock**
Sets the date and time.
- **LCD Contrast** (TD-2350D/TD-2350DF)
Sets the contrast of the LCD.
- **Backlight** (TD-2350D/TD-2350DF)
Sets the backlight on or off.
- **Backlight Timeout** (TD-2350D/TD-2350DF)
Sets the period of time before the backlight turns off if the printer is not used.
- **Display Brightness** (TD-2320DSA/TD-2350DSA)
Sets the display brightness.
- **Home Screen Settings** (TD-2350D/TD-2350DF/TD-2320DSA/TD-2350DSA)
Specifies whether the printer operates in P-touch Template Mode.
P-touch Template Mode allows you to enter only text and print labels using a previously configured template.
- **Template Touchscreen Settings** (TD-2320DSA/TD-2350DSA)
Sets the display format for the template touch mode screen.
- **Search Type** (TD-2320DSA/TD-2350DSA)
Sets the search method when searching for a specific template from the template list.
- **Show Preset Templates** (TD-2350D/TD-2350DF/TD-2320DSA/TD-2350DSA)
Sets whether or not to display the preset templates on the printer.
- **Confirm Print** (TD-2350D/TD-2350DF/TD-2320DSA/TD-2350DSA)
Specifies whether a message appears before printing so that the number of copies can be confirmed.
- **Default Print** (TD-2350D/TD-2350DF/TD-2320DSA/TD-2350DSA)
Specifies the default value for the print quantity.
- **QR Code Data** (TD-2350D/TD-2350DF/TD-2320DSA/TD-2350DSA)
Creates custom QR code data based on the required text or web page and displays it on the printer's LCD.
The displayed QR code can be read using a mobile device to retrieve information.

Management Tab



To display this tab, you must have administrator privileges for the computer or the printer. Check if you have administrator privileges for the printer by clicking the **Printer properties** menu, and then clicking the **Security** tab.

- **Unit** (TD-2350D/TD-2350DF/TD-2320DSA/TD-2350DSA)
Specifies the default unit.
- **Language** (TD-2350D/TD-2350DF/TD-2320DSA/TD-2350DSA)
Specifies the language displayed on the LCD.
- **Airplane Mode** (TD-2350D/TD-2350DF/TD-2350DSA)
Allows disabling the Bluetooth or Wi-Fi interfaces. This function is useful when you use the printer in a place where signal transmissions are not allowed.

-
- **Lock Settings** (TD-2350D/TD-2350DF/TD-2320DSA/TD-2350DSA)
Locks the menu settings so that they cannot be changed.
 - **Admin Password** (TD-2350D/TD-2350DF/TD-2320DSA/TD-2350DSA)
Select **On** to configure administrator mode. Set a four-digit password that must be used change the menu settings.
 - **Disable Edit** (TD-2350D/TD-2350DF/TD-2320DSA/TD-2350DSA)
Selects whether object editing is prohibited or not.
 - **Command Mode**
Selects the command mode type.
 - **Date Format** (TD-2350D/TD-2350DF/TD-2320DSA/TD-2350DSA)
Selects the date format for the clock.
 - **Time Format** (TD-2350D/TD-2350DF/TD-2320DSA/TD-2350DSA)
Selects the time format for the clock.
 - **Print Head Check When Powered On**
Sets whether to check the status of the Print Head when you turn the printer on.



Related Information

- [Change Printer Settings Using the Printer Setting Tool \(Windows\)](#)

Related Topics:

- [Adjust the Sensor Position](#)
-

Printer Setting Tool (Windows): P-touch Template Settings

P-touch Template mode allows you to insert data into text and barcode objects from a downloaded template using other devices connected to the printer. The available options and supplies may vary depending on your country. Use P-touch Template Settings in the Printer Setting Tool to specify or change P-touch Template functions.



- P-touch Template mode is also compatible with other input devices like a scale, testing machine, controller, or a programmable logic device.
- For more information on P-touch Template Settings, see the *P-touch Template Manual/Command Reference* (English only). You can download the latest version from the Brother support website at support.brother.com/manuals.

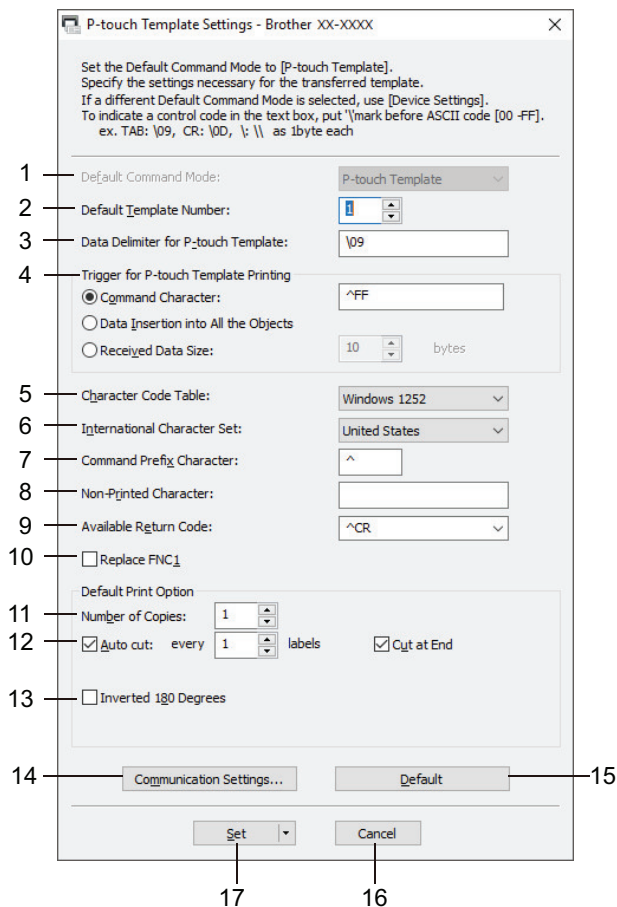

1. Default Command Mode

Specifies the P-touch Template mode as the default mode. To change the mode, select the mode by accessing the **Management** tab on the **Device Settings** window.

2. Default Template Number

Specifies a default template number that the printer sets when it is turned on. If you do not want to transfer a template to the printer, do not specify a template number.

3. Data Delimiter for P-touch Template

Displays a symbol used to indicate the boundaries between groups of data in a file (maximum of 20 characters).

4. Trigger for P-touch Template Printing

Specifies a trigger to begin printing from a number of options.

- **Command Character:** Printing starts when the command character specified here is received.
- **Data Insertion into All the Objects:** Printing starts when the delimiter for the last object is received.

- **Received Data Size:** Printing starts when the number of characters specified here is received. However, delimiters are not counted in the number of characters.

5. Character Code Table

Selects one of the character code sets.

6. International Character Set

Lists character sets for specific countries. The following codes vary depending on the selected country:

23h 24h 40h 5Bh 5Ch 5Dh 5Eh 60h 7Bh 7Ch 7Dh 7Eh

To change the characters, see the *P-touch Template Manual/Command Reference* (English only). You can download the latest version from the Brother support website at support.brother.com/manuals.

7. Command Prefix Character

Specifies the prefix character code identifying commands used in P-touch Template mode.

8. Non-Printed Character

Characters specified here are not printed when data is received (maximum of 20 characters).

9. Available Return Code

The line feed code is used when feeding data to indicate that the following data should be moved to the next line in a text object. Select one of four line feed codes or type the line feed code you want (maximum of 20 characters).

10. Replace FNC1

Replaces GS codes with FNC1.

11. Number of Copies

Sets the number of copies (maximum of 99 copies).

12. Auto Cut

Specifies if the printer should cut the labels and how many labels to print before cutting (maximum of 99 labels).

13. Inverted 180 Degrees

If this checkbox is selected, the data will be printed after it has been rotated 180 degrees.

14. Communication Settings

Sets the parameters for serial communication.

For more information on the parameter setting, see *Related Topics: Connect the Printer to a Computer Using RS-232C*.

15. Default

Returns all setting values in the P-touch Template Settings dialog box to the default values.

16. Cancel

Cancels the settings and closes the dialog box. The settings remain unchanged.

17. Set

Applies the settings to the printer. To save the specified settings to a command file to reuse in the future, select the **Save in Command File** command from the drop-down list.

The saved command file can be used with the mass storage mode to apply the settings to a printer.



Related Information

- [Change Printer Settings Using the Printer Setting Tool \(Windows\)](#)

Related Topics:

- [Print Using a USB Interface \(Mass Storage Mode\)](#)
- [Connect the Printer to a Computer Using RS-232C](#)

Printer Setting Tool (Windows): Paper Size Setup

Use the Paper Size Setup in the Printer Setting Tool to add paper sizes not available in the **Paper Size** list of the printer driver.

Before you print using a paper size other than the available ones, you must register the new paper size by sending it to the printer.

Printing with a paper size not registered with the printer may produce incorrect print results.

Paper Size Setup Dialog Box

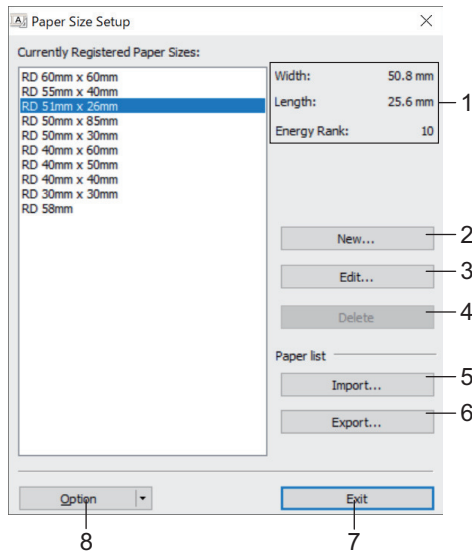

1. Current settings

Displays the current settings for the selected paper format.

2. New

Click this button to display the **New** dialog box and register a new paper size.

NOTE

Do not register a paper size already registered, to avoid incorrect print results. To use paper of the same size as one that is currently registered, select the size you want from the **Currently Registered Paper Sizes** list in the **Paper Size Setup** dialog box, and then change and overwrite the settings from the **Edit** dialog box.

3. Edit

Edits the settings for the selected paper format.

To save the selected paper format with the new settings, click **Overwrite**. To add a paper format with the new settings, change the name in the **Paper Size Name** box, and then click **Add**.

4. Delete

Deletes the selected paper format. A deleted paper format cannot be restored.

5. Import

Reads the text file containing the paper format settings and uses it to replace the contents of the **Currently Registered Paper Sizes** list.

NOTE

When the list is imported, the entire contents of the **Currently Registered Paper Sizes** list will be replaced with the imported paper formats.

6. Export

Exports the paper formats in the **Currently Registered Paper Sizes** list to a file. The exported formats can then be distributed to other computers.

7. Exit

Exits the **Paper Size Setup** window and returns to the main window of the Printer Setting Tool.

8. Option

Click ▼, and then select an operation.

Click **Register Paper Size With Printer** to register the settings for the selected paper format in the printer.

Click **Save in Command File** to export the paper settings as a command file (The file extension is BIN).

NOTE

When the paper format is registered with the printer and **Exit** is clicked, the **Paper Size Setup** dialog box appears with the added paper size in the **Currently Registered Paper Sizes** list. If the software is running, exit the software, and then restart it for the new paper format to appear in the list.



- If the following functions are being used, you can quickly apply their settings to the printer:
 - Mass storage feature
 - Bluetooth (Object Push Profile (OPP)) (TD-2350D/TD-2350DF/TD-2350DSA)
 - Wi-Fi (File Transfer Protocol (FTP)) (TD-2350D/TD-2350DF/TD-2350DSA)
- These commands are only intended to be used to apply settings to a printer. These commands cannot be imported into the Paper Size Setup.

>> [New Dialog Box](#)

>> [Advanced Printing Adjustments Dialog Box](#)

New Dialog Box

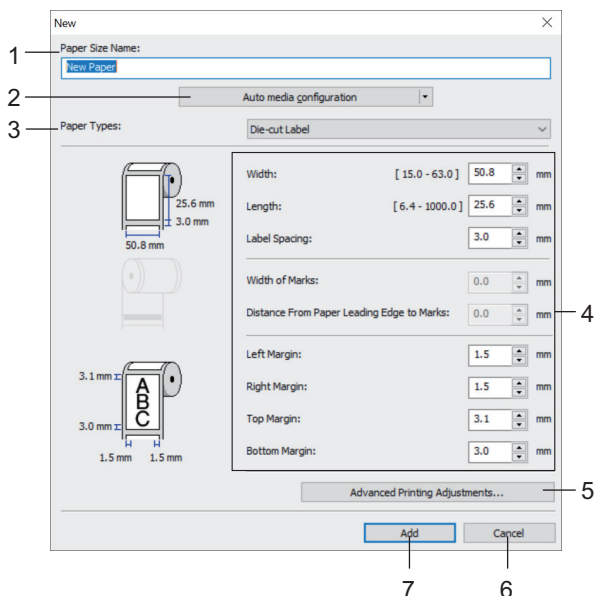

1. Paper Size Name

Type in the name of the paper format to be added.

2. Auto media configuration

Retrieves and displays the information of the paper set in the printer. For more information, see *Related Information*.



Place the printer in idle when using this option. The printer may malfunction if you try to configure it while it is processing or printing a print job.

3. Paper Types

Select the paper type.

4. Detailed settings

Specify details for the paper format to be added.

5. Advanced Printing Adjustments

Click this button to display the **Advanced Printing Adjustments** dialog box and make advanced printing adjustments for each paper format.

6. Cancel

Cancel the settings and closes the dialog box. The settings will remain unchanged.

7. Add

Click this button to add the paper format and apply the settings.

Advanced Printing Adjustments Dialog Box

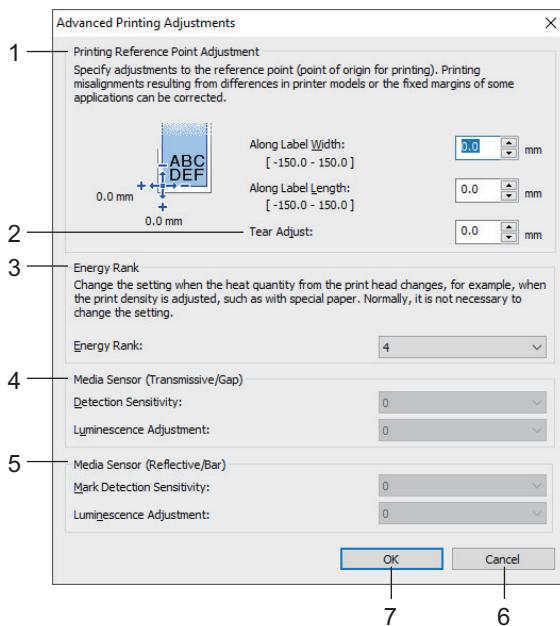

1. Printing Reference Point Adjustment

Adjust the position of the reference point (point of origin for printing). This corrects printing misalignments resulting from differences in printer models or from the fixed margins of some software.

2. Tear Adjust (TD-2310D/TD-2320D/TD-2350D/TD-2320DSA/TD-2350DSA)

Adjust the cutting position when the paper is cut using the Tear Bar.

3. Energy Rank

Adjust the amount of heat (energy) from the Print Head, for example, with special paper.



- There may be contrast variations in the print result due to the operating environment and media used. Modify the settings as necessary.
- If you increase the **Energy Rank** setting, the print result will be darker, and the print speed may be slower.
- If the barcode on the printed label is difficult to read, adjust the **Energy Rank** setting.

4. Media Sensor (Transmissive/Gap) (TD-2320D/TD-2350D/TD-2320DSA/TD-2350DSA)

Adjust the precision with which the transmissive/gap sensor detects the gaps (spacing) for die-cut labels and the amount of light emitted by the sensor.

Settings can be specified when **Paper Types** is set to **Die-cut Label**.



The settings for **Media Sensor (Transmissive/Gap)** in the **Device Settings** dialog box can influence the detection and calibration results. Make sure you specify the appropriate values.

Example settings:

	Setting EX1	Setting EX2
Device Settings	+2	-2
Paper Size Setup	+2	+2
Actual effect	4	0

5. Media Sensor (Reflective/Bar)

Adjust the precision with which the reflective/black mark sensor detects black marks and the amount of light emitted by the sensor.



The settings for **Media Sensor (Reflective/Bar)** in the **Device Settings** dialog box can influence the detection and calibration results. Make sure you specify the appropriate values.

Example settings:

	Setting EX1	Setting EX2
Device Settings	+2	-2
Paper Size Setup	+2	+2
Actual effect	4	0

6. Cancel

Cancels the settings and closes the dialog box. The settings will remain unchanged.

7. OK

Saves the settings and returns to the previous dialog box.



Related Information

- [Change Printer Settings Using the Printer Setting Tool \(Windows\)](#)
 - [Distribute Paper Formats to Other Computers \(Windows\)](#)

Related Topics:

- [Printer Setting Tool \(Windows\): Device Settings](#)
- [Auto Media Configuration](#)
- [Adjust the Sensor Position](#)

Distribute Paper Formats to Other Computers (Windows)

The paper formats exported from the **Currently Registered Paper Sizes** list in the **Paper Size Setup** dialog box can be distributed to other computers. If the printer driver has been installed on the recipient's computer, only the paper formats need to be distributed.

1. At the sender's computer, specify the paper format settings, and then click **Export**.

The following files are created:

TD-2310D 203 dpi Print Resolution	bst2312ed.ptd bst2312ed.txt pdt5435.bin	TD-2310D 300 dpi Print Resolution	bst2313ed.ptd bst2313ed.txt pdt5535.bin
TD-2320D 203 dpi Print Resolution	bst2322ed.ptd bst2322ed.txt pdt5635.bin	TD-2320D 300 dpi Print Resolution	bst2323ed.ptd bst2323ed.txt pdt5735.bin
TD-2320DF 203 dpi Print Resolution	bst232f2ed.ptd bst232f2ed.txt pdt5835.bin	TD-2320DF 300 dpi Print Resolution	bst232f3ed.ptd bst232f3ed.txt pdt5935.bin
TD-2320DSA 203 dpi Print Resolution	bst232s2ed.ptd bst232s2ed.txt pdt5A35.bin	TD-2320DSA 300 dpi Print Resolution	bst232s3ed.ptd bst232s3ed.txt pdt6135.bin
TD-2350D 203 dpi Print Resolution	bst2352ed.ptd bst2352ed.txt pdt6235.bin	TD-2350D 300 dpi Print Resolution	bst2353ed.ptd bst2353ed.txt pdt6335.bin
TD-2350DF 203 dpi Print Resolution	bst235f2ed.ptd bst235f2ed.txt pdt6435.bin	TD-2350DF 300 dpi Print Resolution	bst235f3ed.ptd bst235f3ed.txt pdt6535.bin
TD-2350DSA 203 dpi Print Resolution	bst235s2ed.ptd bst235s2ed.txt pdt6635.bin	TD-2350DSA 300 dpi Print Resolution	bst235s3ed.ptd bst235s3ed.txt pdt6735.bin

2. Save the TXT file in any location on the recipient's computer.
3. At the recipient's computer, click **Import**.

The paper formats are replaced with the imported ones.

✓ Related Information

- [Printer Setting Tool \(Windows\): Paper Size Setup](#)

Apply Setting Changes to Multiple Printers (Windows)

>> [Communication Settings \(TD-2320D/TD-2350D/TD-2320DF/TD-2350DF/TD-2320DSA/TD-2350DSA\)](#)
>> [Device Settings](#)

Communication Settings (TD-2320D/TD-2350D/TD-2320DF/TD-2350DF/ TD-2320DSA/TD-2350DSA)

1. After applying settings to the first printer, disconnect the printer from the computer, and then connect the second printer to the computer.
2. Select the newly connected printer from the **Printer** drop-down list.
If the **Automatically detects the connected printer, and retrieves the current settings** checkbox in the **Option Settings** dialog box is selected, the printer connected with the USB cable is automatically selected.
3. Click **Apply**.
TD-2350D/TD-2350DF/TD-2350DSA: We recommend selecting the **Automatically restart the printer after applying new settings** checkbox when configuring the first printer so that you can confirm that the printer can be correctly connected to the wireless router/access point with the new settings.
The same settings that were applied to the first printer are applied to the second printer.
4. Repeat these steps for all printers whose settings you want to change.



- If the IP address is set to **STATIC**, the printer's IP address is changed to the same address as the first printer. Change the IP address if needed.
- The same settings can be applied to another computer by clicking **File > Import**, and then selecting the exported settings file.

Device Settings

1. After applying settings to the first printer, disconnect the printer from the computer, and then connect the second printer to the computer.
2. Select the newly connected printer from the **Printer** drop-down list.
3. Click **Apply**.
The same settings that were applied to the first printer are applied to the second printer.
4. Repeat these steps for all printers whose settings you want to change.



The same settings can be applied to another computer by clicking **File > Import**, and then selecting the exported settings file.



Related Information

- [Printer Settings](#)

Change Printer Settings Using Web Based Management

Related Models: TD-2320D/TD-2350D/TD-2320DF/TD-2350DF/TD-2320DSA/TD-2350DSA

You can use a standard web browser to change your machine's settings using the Hyper Text Transfer Protocol (HTTP) or Hyper Text Transfer Protocol over Secure Socket Layer (HTTPS).

When using Web Based Management, the following operations are available:

- Displaying your machine status information
- Changing network settings, such as TCP/IP information
- Displaying the machine's software version information
- Changing network and machine configuration details



- We recommend Microsoft Edge for Windows. Make sure that JavaScript and Cookies are always enabled in whichever browser you use.
- The default login password to manage machine settings is located on your machine and marked "Pwd:". We recommend you change it to protect your machine from unauthorised access.

To use Web Based Management, your network must use TCP/IP, and the machine and computer must have a valid IP address.

1. Start your web browser.
2. Type "https://machine's IP address" in your browser's address bar (where "machine's IP address" is the machine's IP address).

For example:

https://192.168.1.2



If you are using a Domain Name System or enable a NetBIOS name, you can type another name, such as "SharedPrinter" instead of the IP address.

For example:

https://SharedPrinter

If you enable a NetBIOS name, you can also use the node name.

For example:

https://brnxxxxxxxxxxxxx

3. If required, type the password in the **Login** field, and then click **Login**.
4. Change the machine settings.

Every time you access Web Based Management, type the password in the **Login** field, and then click **Login**. After configuring the settings, click **Logout**.



Related Information

- [Printer Settings](#)
 - [Change the Login Password Using Web Based Management](#)

Change the Login Password Using Web Based Management

Related Models: TD-2320D/TD-2350D/TD-2320DF/TD-2350DF/TD-2320DSA/TD-2350DSA

The default password to manage this machine's settings is located on the bottom of the machine and marked "**Pwd:**". Change the default password by following the on-screen instructions when you first log in. We recommend immediately changing the default password to protect your machine from unauthorised access. If the battery base unit is installed, uninstall it to confirm the default password.

1. Start your web browser.
2. Type "https://machine's IP address" in your browser's address bar (where "machine's IP address" is your machine's IP address).

For example:

https://192.168.1.2



- If you are using a Domain Name System or enable a NetBIOS name, you can type another name, such as "SharedPrinter" instead of the IP address.

For example: https://SharedPrinter

- If you enable a NetBIOS name, you can also use the node name.

For example: https://brn123456abcdef

- The NetBIOS name can be found in the Network Configuration Report.

3. Do one of the following:
 - If you have previously set your own password, type it, and then click **Login**.
 - If you have not previously set your own password, type the default login password, and then click **Login**.
4. In the left navigation bar, click **Administrator** > **Login Password**.



- The default password to manage this machine's settings is located on the bottom of the machine and marked "**Pwd:**".

- If the left navigation bar is not visible, start navigating from ☰.

5. Following the on-screen **Login Password** guidelines, type your new password in the **Enter New Password** field.
6. Retype the new password in the **Confirm New Password** field.
7. Click **Submit**.



You can also change the lockout settings in the **Login Password** menu.



Related Information

- [Change Printer Settings Using Web Based Management](#)

Confirm Printer Settings

You can print a Printer Settings Report without connecting the printer to a computer or mobile device.

>> [TD-2310D/TD-2320D/TD-2320DF](#)

>> [TD-2350D/TD-2350DF](#)

>> [TD-2320DSA/TD-2350DSA](#)

TD-2310D/TD-2320D/TD-2320DF

1. Turn the printer on.
2. Load a 58 mm or wider Media Roll into the printer.
3. Press and hold  for two seconds.

The report starts printing.



The report includes the model name, serial number, rechargeable Li-ion battery status, error history and more detailed information on the printer's configuration and parameter settings.

To read the printed report, see *Related Topics: Details of Printer Settings Report*.

TD-2350D/TD-2350DF

1. Turn the printer on.
2. Load a 58 mm or wider Media Roll into the printer.
3. Press **Menu**.
4. Press **▲** or **▼** to select the following:
 - a. Select [Information]. Press **OK**.
 - b. Select [Print Configuration]. Press **OK**.
5. Press **▲** or **▼** to select one of the following:

- [All], and then press **OK**.

The report includes all the information provided in the other options.

- [Usage Log], and then press **OK**.

The report includes version information, received data, usage history, and error history.

- [Printer Settings], and then press **OK**.

The report includes version information, printer setting information, network setting list, wireless setting information, and PDL information.

- [Transfer Data], and then press **OK**.

The report includes the template list and the database list.

6. If the printer shows selection menu, press **▲** or **▼** to select [Start].
7. Press **OK**.

To read the printed report, see *Related Topics: Details of Printer Settings Report*.

TD-2320DSA/TD-2350DSA

1. Turn the printer on.
2. Load a 58 mm or wider Media Roll into the printer.
3. Press **Menu**.
4. Press **▲** or **▼** to select the following:
 - a. Select [Information]. Press **OK**.
 - b. Select [Print Configuration]. Press **OK**.

5. Press ▲ or ▼ to select one of the following:

- [All], and then press **OK**.

The report includes all the information provided in the other options.

- [Usage Log], and then press **OK**.

The report includes version information, received data, usage history, and error history.

- [Printer Settings], and then press **OK**.

The report includes version information, printer setting information, network setting list, wireless setting information, and PDL information.

- [Transfer Data], and then press **OK**.

The report includes the template list and the database list.

6. Press **OK** to start to print.

To read the printed report, see *Related Topics: Details of Printer Settings Report*.



Related Information

- [Printer Settings](#)

Related Topics:

- [Replace the Parts](#)
 - [Details of Printer Settings Report](#)
-

Details of Printer Settings Report

These tables contain reference information to help you understand the contents of the Printer Settings Report.

Version Information

Title in Print	Description
<<PRINTER CONFIGURATION>>	Print title (not used in the main unit information acquisition command)
[Printer]	Print title (not used in the main unit information acquisition command)
FormVer	Version of Main unit information output list
LmDBID	ID of the DB where maintenance information is saved
Printer	Printer model name
PrintID	Printer model ID
SerialNo	Serial number
Region	Product destination
ProgVer	Main program version
BootVer	Boot program version
FontVer	Font data version
EromVer	EEPROM format version
BoardVer	Main board version
Region Info	Regional information (product status identification code)
Maintenance Reliability	Maintenance information reliability

Battery Information

Title in Print	Description
[Battery Status]	Print title (not used in the main unit information acquisition command)
Battery Voltage	Battery voltage [mV] If the battery is not connected, "-" will be displayed.
Battery Temperature[deg C]	Battery temperature (current) [°C] If the battery is not connected, "-" will be displayed.

Error History Information

Title in Print	Description
[Error History(PAGES)]	Print title (not used in the main unit information acquisition command)
Last	Information on the most recent error (error number and error summary message)
#01	Error history (latest 10)
#02	This information includes two items as a set, and prints one line for each error.
#03	• Error number
#04	• The total number of pages printed when the error occurs
#05	#01 is the latest error, #10 is the oldest error, and the oldest error #10 is eliminated every time a new error occurs.
#06	
#07	
#08	
#09	
#10	

Media Information

Title in Print	Description
[Media Settings]	Media information (currently set)
Name	Paper name
Width	Printable width
Length	Printable length
Paper Types	Type
Energy Rank	Energy rank
Top Margin	Front margin [dot]
Bottom Margin	Back margin [dot]
Label Pitch	Label pitch [dot]
Mark Offset	Distance to mark [dot]
Position Adj. (H)	Print position correction value (horizontal) [dot]
Position Adj. (V)	Print position correction value (vertical) [dot]
Sensor Adj. (Lum)	Sensor light emission amount adjustment value
Sensor Adj. (Thr)	Sensor threshold adjustment value

Paper

Title in Print	Description
[Paper]	Print title (not used in the main unit information acquisition command)
Binary Data Print	Media information used for printing Lines 1 to 8: Binary data of media information

Printer Settings

Title in Print	Description
[Printer Settings]	Print title (not used in the main unit information acquisition command)
Command Mode	Command mode
Print Density	Print darkness
Print Speed	Printing speed
JPEG Printing	JPEG printing
Text Direction	Print orientation
Exit Position	Issuance method
Auto Cut	Cut settings
Cover Closed Action	Feed setting when cover is closed
Printer Information Report	Contents of main unit information printing
Serialize Mode	Sequential number mode
Save Printer Print Log	Save print history on main unit
Print Data After Printing	Print data after printing
Default Print#	Default number of prints
Power On When Plugged In	Automatic power on (auto power on)
Auto Sleep	Auto sleep
Auto Power Off	Auto power off
Battery Charge Level	Charging settings (ECO charging)
Feed Key	Feed key function settings
Function Key	Function key settings

Title in Print	Description
AirPlane Mode	Bluetooth/WLAN are completely disabled mode
PrintReferencePointAdj.(W)[dot]	Print base point correction (width direction) [dot]
PrintReferencePointAdj.(L)[dot]	Print base point correction (length direction) [dot]
Tear Adjust[mm]	Tear bar position correction [mm]
SensitivityAdj.(Transmissive)	Separator detection level correction Correction value of the light receiving sensor that detects gaps in die-cut labels
LuminescenceAdj(Transmissive)	Correction of luminescence amount (transmissive type)
SensitivityAdj.(Reflective)	Black mark detection level correction
LuminescenceAdj(Reflective)	Correction of light emission amount (reflective type)
SensitivityAdj.(Peeler)	Peeler detection level correction
Menu Locks Settings	Menu lock [Main unit settings] (Locked / Unlocked)
Menu Locks Template Settings	Menu lock [Template settings] (Locked / Unlocked)
Menu Locks Information	Menu lock [Body information] (Locked / Unlocked)
Menu Locks Wired LAN	Menu lock [Wired LAN] (Locked / Unlocked)
Menu Locks WLAN	Menu lock [Wireless LAN] (Locked / Unlocked)
Menu Locks Bluetooth	Menu lock [Bluetooth] (Locked / Unlocked)
Menu Locks Remote Update	Menu lock [Data update] (Locked / Unlocked)
Menu Locks USB Update	Menu lock [USB data update] (Locked / Unlocked)
Menu Locks Support URL	Menu lock [Support site URL] (Locked / Unlocked)
Admin Password	Administrator password (on/off)
LCD Contrast	Screen density
Backlight Settings	Backlight (on/off)
Backlight Timeout	Time until backlight out
Display Brightness	Screen brightness
Template Settings	Template mode
Confirm Print	Check before printing
Date Format	Date format
Time Format	Time format
Language	Language settings
Unit	Unit settings
Beeper	Beeper volume
Clock	Clock function (on/off)
Autotime Sync	Automatic time acquisition settings
Time Zone	Time zone settings
SNTP Server Method	NTP server settings (SNTP Server Method)
Primary SNTP Server Address	NTP server settings (Primary SNTP Server Address)
Primary SNTP Server Port	NTP server settings (Primary SNTP Server Port)
Secondary SNTP Server Address	NTP server settings (Secondary SNTP Server Address)
Secondary SNTP Server Port	NTP server settings (Secondary SNTP Server Port)
Synchronization Interval	NTP server settings (Synchronization Interval)
Web Based Management	EWS on/off settings
Update Notification	Firmware update automatic notification

Title in Print	Description
[P-touch Template Settings]	Print title (not used in the main unit information acquisition command)
Touch Mode Settings	Template Touch mode display settings
Default Template Number	Template number initial value
Data Delimiter	Delimiter
Print Start Trigger	Print start trigger
Command Character	Print start command string
Received Data Size	Print start data size When printing a P-Touch Template: Received data size to start printing when the print start trigger is "Number Of Character Received".
Character Code Table	Character code set When printing a P-Touch Template: Character code set to use (see command reference for details).
International Character Set	International characters When printing a P-Touch Template: Some code characters will be replaced according to this setting. (See command reference for details).
Command Prefix Character	Prefix character
Non-Printed Character	Discarded string
Available Return Code	New line code
Replace FNC1	FNC1 replacement
Virtual Future Date	Direct date entry (on/off)
Virtual Future Time	Direct time input (on/off)
Search Method Setting	Search mode settings
Default Template	Built-in template display (Japan Only)
[PDL]	Print title (not used in the main unit information acquisition command)
FmtPrefix	Current ZPL command prefix character
CtrPrefix	Current ZPL command prefix character
Delimiter	Current ZPL command delimiter
CRC Check	CRC check setting in SBPL emulation (enable/disable)
[Option]	Print title (not used in the main unit information acquisition command)
Cutter Option	Cutter option (with/without)
Label Peeler	Peeler option (with/without)
Coin Battery Level	Coin battery remaining charge

RS-232C Serial Communication Setting Information

Title in Print	Description
[Serial]	Print title (not used in the main unit information acquisition command)
Baud rate(bps)	RS-232C baud rate
Data bit	RS-232C data bit length
Parity	RS-232C parity setting
Flow control	RS-232C flow control settings

Bluetooth Setting Information

Title in Print	Description
[Bluetooth]	Print title (not used in the main unit information acquisition command)

Title in Print	Description
Bluetooth Usage	Bluetooth activation status (enabled/disabled) If disabled, all items below will be displayed as '-' (hyphen).
Bluetooth Firmware Ver.	Bluetooth HCD file version information
Bluetooth Device Name	Bluetooth device name
Bluetooth On Power On	Bluetooth status when power is turned on
Visible to Other Devices	Search from other devices
Bluetooth Mode	Bluetooth control mode
Automatic Reconnection	Automatic reconnection (Classic)
Target Address	Bluetooth address for automatic reconnection (Classic)
Minimum Security Mode	Minimum security (Low Energy)
Bluetooth Address	Bluetooth address
Security Mode	Bluetooth security mode setting
Bluetooth Server TimeOut	Bluetooth automatic reconnection time out
Bluetooth Last Address	Bluetooth last connected device address
Bluetooth Last Device	Last configured device
AutoMatically Search	Automatic search

Bluetooth Address Barcode

Title in Print	Description
(Barcode image)	Bluetooth device address barcode Format: CODE128, bottom character ON, height 79 dots (10 mm), width = very small, thin bar/thick bar ratio = 3:1, bar lengths not the same

WLAN Configuration Information

Title in Print	Description
[WLAN]	Print title (not used in the main unit information acquisition command)
WLAN Region	Wireless LAN destination settings
WLAN On Power On	Wireless settings at power on (Wireless LAN on/off)
Network Mode	Network mode (Infrastructure/Direct/Infra&Direct/Ad hoc)
RSSI	Received signal strength (Wireless LAN, Wireless Direct)
Channel	Channel
WLAN Status	Wireless LAN status (enabled/WLAN off/not connected)
Node Name	Wireless LAN node name
MAC Address	Wireless LAN MAC address
SSID	Connection destination SSID (network name)
Encryption Mode	Encryption method
Authentication Method	Authentication method
Boot Method	Method for setting IP addresses
IP Address	Wireless LAN IP address
Subnet Mask	Sub-net mask
Gateway Address	Gateway address
DNS Address	DNS server address (IPv4)
IPv6 Address	IPv6 address

Title in Print	Description
IPv6 DNS Address	DNS server address (IPv6)
WFD Status	Wireless Direct status (off/group owner active)
WFD SSID	Wireless Direct SSID
WFD Channel	Channel for Wireless Direct connection
WFD MAC Address	Wireless Direct MAC address
WFD IP Address	Wireless Direct IP address

Wired LAN Setting Information

Title in Print	Description
[WiredLAN]	Print title (not used in the main unit information acquisition command)
WiredLAN Status	Wired LAN status (offline/online)
Node Name	Node name
MAC Address	MAC address
Boot Method	Method for setting IP addresses
IP Address	IP address
Subnet Mask	Sub-net mask
Gateway Address	Gateway address
DNS Address	DNS server address (IPv4)
IPv6 Address	IPv6 address
IPv6 DNS Address	DNS server address (IPv6)

Support Site URL QR Code

Title in Print	Description
<<PRODUCT SUPPORT WEBSITE>>	Print a QR code with the URL of the support site.

Main Unit Transfer Data List

Title in Print	Description
[Template List]	List of template names transferred to the printer
[Database List]	List of database names transferred to the printer
[Font List]	List of font names downloaded to the printer
Available memory	Free space in FlashROM (user area) [bytes]

Main Unit Transfer Data Usage Status

Title in Print	Description
Available memory[per]	Free space in FlashROM (user area) [%]

EWS Initial Password

Title in Print	Description
Default Password	EWS initial password

Main Unit Usage History (User)

Title in Print	Description
[Usage Information]	Print title (not used in the main unit information acquisition command)
Print Count (Total)	Print number counter
Print Job Count (Total)	Job counter

Title in Print	Description
Print Distance (Total)[m]	Print distance counter (m) (Conveyance distance when printing in the forward direction only, excluding margins. White data is included in the print distance)
Print Distance (Total)[dot]	Print distance counter (dot)
Feed Distance (Total)[m]	Total transport distance counter (m) (All conveyance distances, including margins, conveying other than printing (feeding, etc.), and reverse transport, are also included in the conveyance distance.)
Feed Distance (Total)[dot]	Total conveyance distance counter (dot)
Full Cutter Count (Total)	Full cut counter
Full Cutter Count (1)	Full cut counter updated when replacing cutter (currently)
Head Disconnection dots[dot]	Head disconnection count [dots] (recent check results)
Feed Distance (Head1)[m]	Conveyance distance counter updated when Print Head replacement is detected (currently)
Feed Distance (Platen1)[m]	Conveyance distance counter updated when Platen Roller replacement is detected (current)
Feed Count	Feed count
Environmental Temperature (Current) [degC]	Environmental temperature (current) [°C]

Error History Information

Title in Print	Description
[Error Count]	Print title (not used in the main unit information acquisition command)
Error Count Total	Number of error occurrences
Error Count #[Array:##]	Number of occurrences of error [Array:##] (if 1 digit, omit the 2nd digit)
System Error Count #[Array:##]	Number of occurrences of system error [Array:##] (if it is 1 digit, the 2nd digit is omitted)

Main Unit Usage History (Maintenance)

Title in Print	Description
Print Distance (User1)[m]	User-resettable print distance counter (currently)
Print Distance (Head1)[m]	Printing distance counter updated when head replacement is detected (currently)
Print Distance (Head2)[m]	Printing distance counter updated when detecting head replacement (1 previous)
Print Distance (Head3)[m]	Printing distance counter updated when detecting head replacement (2 previous)
Head Replacement Count	Number of head replacements [times] (number of times replacement was detected)
Print Distance (Average)[dot]	Average page length (=total printing distance / total number of pages printed)
Print Count (USB1)	Number of prints via USB
Print Count (USB2)	Number of prints via USB (via option)
Print Count (USB HOST)	Number of prints on USBHOST (Barcode reader, USB memory, etc.)
Print Count (Bluetooth)	Number of prints via Bluetooth
Print Count (Bluetooth LE)	Number of prints with Bluetooth LE
Print Count (AirPrint)	Number of prints with AirPrint

Title in Print	Description
Print Count (USB MSC)	Number of prints with USB Mass Storage
Print Count (Network)	Number of prints via network (Wired/Wireless LAN)
Print Count (Standalone)	Number of prints on the main unit
Print Count (RS232C)	Number of prints with RS-232C
Print Count (Internal)	Number of prints when only internal power supply (battery) is installed
Print Count (External)	Number of prints when only external power supply (adapter, USB power supply) is connected
Print Count (Combination)	Number of prints when both internal and external power supplies are connected
Print Count (Other)	Print count of other commands
Print Count (Raster)	Number of prints in Raster
Print Count (ESCP)	Number of prints with ESC/P
Print Count (P-Template)	Number of prints with P-touch Template
Print Count (ZPL emulation)	Number of prints with ZPL emulation
Print Count (CPCL emulation)	Number of prints with CPCL emulation
Print Count (SBPL emulation)	Number of prints with SBPL emulation
Print Count (Density [Array:##])	Number of prints at density [Array:##]
Print Count (Duty0-4%)	Number of prints with print duty 0 to 4%
Print Count (Duty5-9%)	Number of prints with print duty 5 to 9%
Print Count (Duty10-14%)	Number of prints with print duty 10 to 14%
Print Count (Duty15-19%)	Number of prints with print duty 15 to 19%
Print Count (Duty20-24%)	Number of prints with print duty 20 to 24%
Print Count (Duty25-29%)	Number of prints with print duty 25 to 29%
Print Count (Duty30-34%)	Number of prints with print duty 30 to 34%
Print Count (Duty35-39%)	Number of prints with print duty 35 to 39%
Print Count (Duty40-44%)	Number of prints with print duty 40 to 44%
Print Count (Duty45-49%)	Number of prints with print duty 45 to 49%
Print Count (Duty50-54%)	Number of prints with print duty 50 to 54%
Print Count (Duty55-59%)	Number of prints with print duty 55 to 59%
Print Count (Duty60-64%)	Number of prints with print duty 60 to 64%
Print Count (Duty65-69%)	Number of prints with print duty 65 to 69%
Print Count (Duty70-74%)	Number of prints with print duty 70 to 74%
Print Count (Duty75-79%)	Number of prints with print duty 75 to 79%
Print Count (Duty80-84%)	Number of prints with print duty 80 to 84%
Print Count (Duty85-89%)	Number of prints with print duty 85 to 89%
Print Count (Duty90-94%)	Number of prints with print duty 90 to 94%
Print Count (Duty95-100%)	Number of prints with print duty 95 to 100%
Average Coverage (Total)[%]	Average printing rate (calculated value) for effective dots [%]
Full Cut Time[msec]	Latest full cut time (time from start to end of operation)
Head Temperature (Min.)[degC]	Minimum Print Head temperature
Head Temperature (Max.)[degC]	Maximum Print Head temperature
Peeler Sensor[AD]	Peeler sensor voltage AD value when the LED is off during peeler operation (recent)

Title in Print	Description
Peeler Disturbed light[AD][Array:XX]	Peeler sensor ambient light AD value when power is turned on (best 3)
Cooling Count (head)	Cooling due to Print Head
Cooling Count (motor)	Cooling motor
Button Push Count (Power)	Button press counter (Power)
Button Push Count (Esc)	Button press counter (Esc)
Button Push Count (Menu)	Button press counter (Menu)
Button Push Count (Feed)	Button press counter (Feed)
Button Push Count (Up)	Button press counter (Up)
Button Push Count (Down)	Button press counter (Down)
Button Push Count (OK)	Button press counter (OK)
Button Push Count (Function)	Button press counter (Function)
Cover Open Count	Cover open counter
Environmental Temperature (Min.)[degC]	Environmental temperature (minimum) [°C]
Environmental Temperature (Max.)[degC]	Environmental temperature (maximum) [°C]
Environmental Temperature (Avg.)[degC]	Average environmental temperature [°C]
Environmental Temperature (SD)[degC]	Standard deviation of environmental temperature [°C]
Media #01	Information on the media with the highest number of prints.
Name:	Name
Width:[dot]	Media width
Length:[dot]	Medium length
Type:	Type
Energy:	Energy rank
Cut count:	Number of cuts
Distance:	Print Distance
Count:	The number of printed sheets
Sensor Adj. (Lum):	Sensor light emission amount adjustment value
Sensor Adj. (Thr);	Sensor threshold adjustment value
Media #02	Information on the medium with the second highest number of copies printed.
Name:	Name
Width:[dot]	Media width
Length:[dot]	Medium length
Type:	Type
Energy:	Energy rank
Cut count:	Number of cuts
Distance:	Print Distance
Count:	The number of printed sheets
Sensor Adj. (Lum):	Sensor light emission amount adjustment value
Sensor Adj. (Thr);	Sensor threshold adjustment value
Battery Charge Count (Total)	Total number of battery charges [times] (Number of times the battery has been recharged from an uncharged state to a charged state)

Title in Print	Description
Battery Charge Finish Count (Total)	Total number of battery charge completions [times] (Number of times the battery is fully charged and the charge is completed)
Battery Charge Time (Total)	Total battery charging time [minutes] (Accumulated value of charging state time)
Total Power On Time	Total power on time [minutes]
Total Power On Count	Total number of power on times [times]
Battery Charge Count Level FC	Battery charging start voltage level: Full charge
Battery Charge Count Level UV	Battery charging start voltage level: Intermediate voltage
Battery Charge Count Level OD	Battery charging start voltage level: Low (charging required)
First Setup Date	Initial date and time setting (product operation start) (YYYY/MM/DD notation)



Related Information

- [Printer Settings](#)

Related Topics:

- [Confirm Printer Settings](#)

-
6. Follow the on-screen instructions.
 7. When the printer's LCD displays a processing message, the printer starts printing automatically. If it does not print, press  to print the dump data.



To resume normal printing, turn the printer off and then on again.

TD-2310D/TD-2320D/TD-2350D/TD-2320DF/TD-2350DF/TD-2320DSA/TD-2350DSA

To set the printer to Dump Mode using the Printer Setting Tool.

1. Connect the printer to the computer using a USB cable.
2. Press  to turn the printer on.
3. Start the Printer Setting Tool.
Click **Start > Brother > Printer Setting Tool**.
4. Click **Device Settings**.
5. Click **Maintenance > Switch to Dump Mode**.
6. When prompted, click **OK** to confirm.
The printer switches to Dump Mode.



To resume normal printing, turn the printer off and then on again.



Related Information

- [Printer Settings](#)
-

Change Printer Settings Using the Printer

Related Models: TD-2350D/TD-2350DF/TD-2320DSA/TD-2350DSA



You can also change the printer settings using the Printer Setting Tool on a computer connected to the printer.

>> [TD-2350D/TD-2350DF](#)

>> [TD-2320DSA/TD-2350DSA](#)

TD-2350D/TD-2350DF

1. Press **Menu**.
2. Press **▲** or **▼** to select a menu option, and then press **OK**.
3. Press **▲** or **▼** to select an option, and then press **OK**.

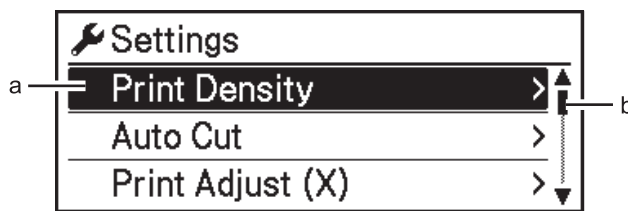

- a. The current selection is highlighted.
- b. The scroll bar shows the position of the highlighted option on the list.

TD-2320DSA/TD-2350DSA

1. Press **Menu**.
2. Press **▲** or **▼** to select a menu option, and then press **OK**.
3. Press **▲** or **▼** to select an option, and then press **OK**.

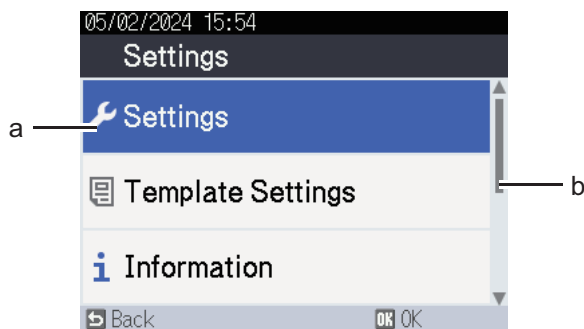

- a. The current selection is highlighted.
- b. The scroll bar shows the position of the highlighted option on the list.

✓ Related Information

- [Printer Settings](#)
 - [Settings Tables](#)
 - [Settings Tables](#)

Related Topics:

- [Change Printer Settings Using the Printer Setting Tool \(Windows\)](#)

Settings Tables

Related Models: TD-2350D/TD-2350DF

The Settings tables will help you understand the menu selections and options.



Some settings may differ depending on the firmware (printer software).

- >> [Settings]
- >> [Template Settings]
- >> [Information]
- >> [Administration]
- >> [Remote Update] Network
- >> [Update from USB] USB Flash Drive
- >> [Wired LAN]
- >> [WLAN]
- >> [Bluetooth]
- >> [Media]
- >> [Custom QR Code]

[Settings]

Level 1	Level 2	Descriptions
Print Density	-	Adjust the printer's printing density.
Auto Cut	-	Set the cutting method when printing multiple labels.
Print Adjust (X)	-	Adjust the print position.
Print Adjust (Y)	-	Adjust the print position.
Exit Position	-	Select the media exit location.
Tear Position	-	Adjust the tear position.
Print Speed	-	Select the printer's printing speed.
Text Direction	-	Select the printing orientation.
Auto Power Off	-	Specify the period of time that passes before the printer turns off automatically.
Auto Sleep	-	Set the amount of time to pass before the printer automatically enters sleep mode.
LCD Contrast	-	Set the contrast of the LCD. The higher the number, the stronger the contrast.
Backlight	-	Switch the backlight on or off.
Sensor (Transmissive)	Detection Sensitivity	Adjust the sensitivity of the sensor that detects the gaps (spacing) for die-cut labels.
	Luminescence	Adjust the amount of light emitted by the transmissive/gap sensor.
Sensor (Reflective)	Mark Detection	Adjust the precision of the sensor that detects the black marks.
	Luminescence	Adjust the amount of light emitted by the reflective/black mark sensor.
Charge Setting	-	Select the charge percentage to stop charging the battery.
Home Screen	-	Select the screen displayed in standby mode.
Cover Setting	-	Select the action after closing the Roll Compartment Cover.

[Template Settings]

Level 1	Level 2	Descriptions
Confirm Print	-	Select whether a message appears before printing so that the number of copies can be confirmed.
Serialize Mode	Cont From Last	Select to serialise from the last number printed.
	From Starting #	Select to serialise from the default number each time you print.
Serialize Reset	-	Reset the sequential number to the default number.
Default Print Quantity	-	Specify the default value for the print quantity.
Temporary Date	-	Enter the date directly into the template.
Temporary Time	-	Enter the time directly into the template.
Default Templates	-	Select whether or not to display preset templates.

[Information]

Level 1	Level 2	Descriptions
Information	-	Display information when the information icon is displayed.
Configuration	-	Display the printer information.
Print Configuration	All	Print the printer setup information (missing dot test pattern, usage log, printer settings, wireless setting information, and transfer data).
	Usage Log	Print the printer usage log.
	Printer Settings	Print the printer settings.
	Transfer Data	Print the transfer data.

[Administration]

To prevent date and time changes made by printer operations, set a passcode for the [Administration] menu to ensure security.

Level 1	Level 2	Descriptions
Command Mode	-	Select the type of command mode.
Date Format	-	Select the date format.
Time Format	-	Select the time format for the clock.
 Language	-	Select the language of the LCD.
Unit	-	Select the measurement units for displayed settings.
Reset	Factory Reset	Returns all printer settings, including the communication settings and device settings, to their default values. Templates and databases stored in the printer are also deleted.
	User Data Reset	Returns all device settings to their default values. Templates and databases stored in the printer are also deleted.
	Network Reset	Returns the communication settings to their default values.
Airplane Mode	-	Turn Airplane mode on or off. When set to on, WLAN and Bluetooth functions are deactivated.
Time & date	AutoSync Time	Select whether or not to use the date and time obtained from an NTP server.
	Set Clock	Set the date, time, and display format (12-hour or 24-hour format).

Level 1	Level 2	Descriptions
Time & date	Clock (On/Off)	Select whether to display the date and time on the LCD.
Print Head Check	-	Check the status of the Print Head.
Menu Lock	-	Select the checkboxes for any options you want to prevent changes from the printer's LCD. After selecting the checkboxes, press ▲ or ▼ to select Finish, and then press OK to complete the settings. If the Menu Locks are set, a lock icon is displayed for parameters that cannot be selected.
Menu Security	-	Select if a passcode is required to enter the Administration mode. When set to on, specify the four-digit password.
Dump Mode	-	Print information on data received to date.
Web Based Management	-	Select whether to use Web Based Management.
Firmware Update	Check Update	Check for updated firmware and implement the update.
	Update Notification	Set up periodic checks for firmware updates and receive notifications when updates are available.

[Remote Update] Network

Level 1	Level 2	Descriptions
Remote Update	-	Available only when the printer is connected to the FTP server and when the templates, databases, and other files need to be updated.

To set the FTP server information, you must first go to **Communication Settings** in the Printer Setting Tool.

[Update from USB] USB Flash Drive

Level 1	Level 2	Descriptions
Update from USB	-	Available only when a USB flash drive containing saved templates, databases, and other files that need to be updated is connected to the printer.
Backup	-	Export and import settings by using a USB flash drive.
Restore	-	Export and import settings by using a USB flash drive.

[Wired LAN]

Level 1	Level 2	Descriptions
TCP/IP Settings	-	Specify TCP/IP settings.
Wired LAN Status	-	Display the Wired LAN status.

[WLAN]

Level 1	Level 2	Descriptions
WLAN (On/Off)	-	Turn the WLAN function on or off.
Network Mode	Infrastructure Mode	Select the network mode when you set the WLAN function to on.
	Direct Mode	
	Infra/Direct Mode	
WPS Button Push	-	Try to connect to a nearby wireless access point/router.
WPS PIN Code	-	Display the printer's eight-digit PIN.

Level 1	Level 2	Descriptions
Infra Manual Setup	-	Establish a WLAN connection manually in infrastructure mode. Display the SSID of a nearby wireless access point/router. After you select the SSID and press OK , the password entry screen appears.
Direct Manual Setup	-	Establish a WLAN connection manually in wireless direct mode. Manually enter the SSID and password of a wireless device.
TCP/IP Settings	Auto	Specify TCP/IP settings.
	Static	
WLAN Status	Infrastructure Mode	Display the WLAN status.
	Direct Mode	

[Bluetooth]

Level 1	Level 2	Descriptions
Bluetooth (On/Off)	-	Turn the Bluetooth function on or off.
Mode	Classic & LE	Select Bluetooth mode.
	Classic	
	Low Energy	
Print Barcode	-	Print the Bluetooth address and corresponding barcode.
Automatic Reconnection	-	Switch to Automatic Reconnection mode (only for Apple devices: iPad, iPhone, or iPod touch).
Clear History	-	Delete automatically paired devices registered in the printer.
View Auth Code	-	Select whether to perform confirmation during Bluetooth pairing.
Bluetooth Secure Connect	Standard Mode	Select the security mode for Bluetooth connection.
	Secure Mode	
Bluetooth Status	-	Display the status of the Bluetooth function.

[Media]

Level 1	Level 2	Descriptions
Selection	-	Select the paper size and paper type.
Calibration	-	Detect the size of the set paper.
Margin Width Setting	-	Configure the margin width (right/left) of the backing paper.
Detection	-	Display paper settings in the <i>Selection</i> option that match the detection results from the paper settings registered with the Printer Setting Tool.

[Custom QR Code]

Display the custom QR code set with the Printer Setting Tool.



Related Information

- [Change Printer Settings Using the Printer](#)

Settings Tables

Related Models: TD-2320DSA/TD-2350DSA

The Settings tables will help you understand the menu selections and options.



Some settings may differ depending on the firmware (printer software).

- >> [Settings]
- >> [Template Settings]
- >> [Information]
- >> [Administration]
- >> [Remote Update] Network
- >> [Update from USB] USB Flash Drive
- >> [Wired LAN]
- >> [WLAN] TD-2350DSA
- >> [Bluetooth] TD-2350DSA
- >> [Media]
- >> [Custom QR Code]

[Settings]

Level 1	Level 2	Descriptions
Print Density	-	Adjust the printer's printing density.
Auto Cut	-	Set the cutting method when printing multiple labels.
Print Adjust (X)	-	Adjust the print position.
Print Adjust (Y)	-	Adjust the print position.
Exit Position	-	Select the media exit location.
Tear Position	-	Adjust the tear position.
Print Speed	-	Select the printer's printing speed.
Text Direction	-	Select the printing orientation.
Auto Power Off	-	Specify the period of time that passes before the printer turns off automatically.
Auto Sleep	-	Set the amount of time to pass before the printer automatically enters sleep mode.
Display Brightness	-	Select the display brightness.
Sensor (Transmissive)	Detection Sensitivity	Adjust the sensitivity of the sensor that detects the gaps (spacing) for die-cut labels.
	Luminescence	Adjust the amount of light emitted by the transmissive/gap sensor.
Sensor (Reflective)	Mark Detection	Adjust the precision of the sensor that detects the black marks.
	Luminescence	Adjust the amount of light emitted by the reflective/black mark sensor.
Charge Setting	-	Select the charge percentage to stop charging the battery.
Beeper	-	Select the beep volume.
Home Screen	-	Select the screen displayed in standby mode.
Cover Setting	-	Select the action after closing the Roll Compartment Cover.

[Template Settings]

Level 1	Level 2	Descriptions
Touch Mode Setting	-	Select the template display style in template touch mode.
Confirm Print	-	Select whether a message appears before printing so that the number of copies can be confirmed.
Serialize Mode	Cont From Last	Select to serialise from the last number printed.
	From Starting #	Select to serialise from the default number each time you print.
Serialize Reset	-	Reset the sequential number to the default number.
Default Print Quantity	-	Specify the default value for the print quantity.
Temporary Date	-	Enter the date directly into the template.
Temporary Time	-	Enter the time directly into the template.
Search Settings	Numerical search	Select the search mode you want to use.
	Product name search	
Default Templates	-	Select whether or not to display preset templates.
Default Template Setting	On	Turn On to display the selected template when the printer is turned on.
	Off	
Default Template Number	-	Select the default template.

[Information]

Level 1	Level 2	Descriptions
Information	-	Display information when the information icon is displayed.
Configuration	-	Display the printer information.
Print Configuration	All	Print the printer setup information (missing dot test pattern, usage log, printer settings, wireless setting information, and transfer data).
	Usage Log	Print the printer usage log.
	Printer Settings	Print the printer settings.
	Transfer Data	Print the transfer data.
Print History	-	View print history on the display.

[Administration]

To prevent date and time changes made by printer operations, set a passcode for the [Administration] menu to ensure security.

Level 1	Level 2	Descriptions
Command Mode	-	Select the type of command mode.
Date Format	-	Select the date format.
Time Format	-	Select the time format for the clock.
 Language	-	Select the language of the LCD.
Unit	-	Select the measurement units for displayed settings.

Level 1	Level 2	Descriptions
Reset	Factory Reset	Returns all printer settings, including the communication settings and device settings, to their default values. Templates and databases stored in the printer are also deleted.
	User Data Reset	Returns all device settings to their default values. Templates and databases stored in the printer are also deleted.
	Network Reset	Returns the communication settings to their default values.
Airplane Mode	-	Turn Airplane mode on or off. When set to on, WLAN and Bluetooth functions are deactivated. (TD-2350DSA)
Database	-	Select the database stored in the printer and make edits to it.
Time & date	AutoSync Time	Select whether or not to use the date and time obtained from an NTP server.
	Clock Manual Setup	Set the date, time, and display format (12-hour or 24-hour format).
	Clock (On/Off)	Select whether to display the date and time on the LCD.
Print Head Check	-	Check the status of the Print Head.
Disable Edit	-	Disable transition to template editing Mode and prevent template editing.
Menu Lock	-	Select the checkboxes for any options you want to prevent changes from the printer's LCD. After selecting the checkboxes, press ▲ or ▼ to select Finish, and then press OK to complete the settings. If the Menu Locks are set, a lock icon is displayed for parameters that cannot be selected.
Menu Security	-	Select if a passcode is required to enter the Administration mode. When set to on, specify the four-digit password.
Dump Mode	-	Print information on data received to date.
Web Based Management	-	Select whether to use Web Based Management.
Firmware Update	Check Update	Check for updated firmware and implement the update.
	Update Notification	Set up periodic checks for firmware updates and receive notifications when updates are available.

[Remote Update] Network

Level 1	Level 2	Descriptions
Remote Update	-	Available only when the printer is connected to the FTP server and when the templates, databases, and other files need to be updated.

To set the FTP server information, you must first go to **Communication Settings** in the Printer Setting Tool.

[Update from USB] USB Flash Drive

Level 1	Level 2	Descriptions
Update from USB	-	Available only when a USB flash drive containing saved templates, databases, and other files that need to be updated is connected to the printer.
Backup	-	Export and import settings by using a USB flash drive.
Restore	-	Export and import settings by using a USB flash drive.

[Wired LAN]

Level 1	Level 2	Descriptions
TCP/IP Settings	-	Specify TCP/IP settings.
Wired LAN Status	-	Display the Wired LAN status.

[WLAN] TD-2350DSA

Level 1	Level 2	Descriptions
WLAN (On/Off)	-	Turn the WLAN function on or off.
Network Mode	Infrastructure Mode	Select the network mode when you set the WLAN function to on.
	Direct Mode	
	Infra/Direct Mode	
WPS Button Push	-	Try to connect to a nearby wireless access point/router.
WPS PIN Code	-	Display the printer's eight-digit PIN.
Infra Manual Setup	-	Display the SSID of a nearby wireless access point/router. After you select the SSID and press OK , the password entry screen appears.
Direct Manual Setup	-	Manually enter the SSID and password of a wireless device.
TCP/IP Settings	Auto	Specify TCP/IP settings.
	Static	
WLAN Status	Infrastructure Mode	Display the WLAN status.
	Direct Mode	

[Bluetooth] TD-2350DSA

Level 1	Level 2	Descriptions
Bluetooth (On/Off)	-	Turn the Bluetooth function on or off.
Mode	Classic & LE	Select Bluetooth mode.
	Classic	
	Low Energy	
Print Barcode	-	Print the Bluetooth address and corresponding barcode.
Automatic Reconnection	-	Switch to Automatic Reconnection mode (only for Apple devices: iPad, iPhone, or iPod touch).
Clear History	-	Delete automatically paired devices registered in the printer.
View Auth Code	-	Select whether to perform confirmation during Bluetooth pairing.
Bluetooth Secure Connect	Standard Mode	Select the security mode for Bluetooth connection.
	Secure Mode	
Bluetooth Status	-	Display the status of the Bluetooth function.

[Media]

Level 1	Level 2	Descriptions
Selection	-	Select the paper size and paper type.
Calibration	-	Detect the size of the set paper.

Level 1	Level 2	Descriptions
Margin Width Setting	-	Configure the margin width (right/left) of the backing paper.
Detection	-	Display paper settings in the <i>Selection</i> option that match the detection results from the paper settings registered with the Printer Setting Tool.

[Custom QR Code]

Display the custom QR code set with the Printer Setting Tool.



Related Information

- [Change Printer Settings Using the Printer](#)
-

Routine Maintenance

- [Clean Your Printer](#)
- [Replace the Coin Cell Battery](#)
- [Replace the Parts](#)
- [Check the Print Head](#)

Clean Your Printer

We recommend cleaning your printer on a regular basis to maintain its correct performance.

Always disconnect the printer from any power source before cleaning.

- >> [Cleaning Outside of Unit with Disinfectant Solution](#)
- >> [Clean the Exterior of the Unit](#)
- >> [Clean the Label Exit Slot](#)
- >> [Clean the Label Exit Slot and the Roller of Linerless Models](#)
- >> [Clean the Roller](#)
- >> [Clean the Print Head](#)
- >> [Clean the Print Head of Linerless Models](#)
- >> [Clean the Roll Guides](#)
- >> [Clean the Label Support](#)
- >> [Clean the Label Peeler](#)

Cleaning Outside of Unit with Disinfectant Solution

- Prepare materials:
 - Disinfectant solution
We recommend using Hypochlorite water ¹ or diluted ethanol ².
Avoid using sodium hypochlorite ³.
 - Lint free cloth
- Turn the printer off, unplug the AC Adapter and AC Power Cord, and remove the battery.
Lightly spray a soft, lint-free cloth with disinfectant, and wipe the printer's surfaces gently and quickly. After wiping, leave the covers open and wait until the moisture dries completely.
After drying, attach the power plug and battery.

IMPORTANT

- Turn the printer off, remove the power plug, and remove the battery before disinfecting.
- DO NOT spray disinfectant directly onto the printer.
- Prevent moisture from entering the heat dissipation holes and gaps around buttons, connectors, and battery terminals.
- DO NOT use flammable sprays or organic solvents such as benzine or thinner. There is a risk of fire or electric shock.
- DO NOT use detergents that contain bleach or abrasives.
- When disinfecting handheld items, refrain from holding them in your hand but instead place them on a table.
- When using diluted ethanol as a disinfectant, move to a well-ventilated room.
- Wash your hands thoroughly after using disinfectants.

Clean the Exterior of the Unit

Wipe any dust and marks from the main unit using a soft, dry cloth. Use a cloth slightly damp with water on difficult to remove marks.

¹ Hypochlorous acid water, an aqueous solution, is used to clean and disinfect food, machinery, and equipment, as well as for hand washing.

² Dilute in the ratio of anhydrous ethanol: 7, water: 3.

³ There are products with names similar to hypochlorous acid water that contain sodium hypochlorite as an ingredient, but sodium hypochlorite solutions contain bleach. These products are not suitable for disinfecting the product and should not be used.

IMPORTANT

DO NOT use paint thinner, benzene, alcohol or any other organic solvent. These may deform or damage the printer case.

Clean the Label Exit Slot

If adhesive residue gets attached to the Label Exit Slot, it may cause label jams. Clean the Label Exit Slot with a dry cotton swab.

IMPORTANT

DO NOT use alcohol to clean the Label Exit Slot.

NOTE

Always remove the ejected labels from the Label Exit Slot. If the slot becomes blocked, label jams may occur.

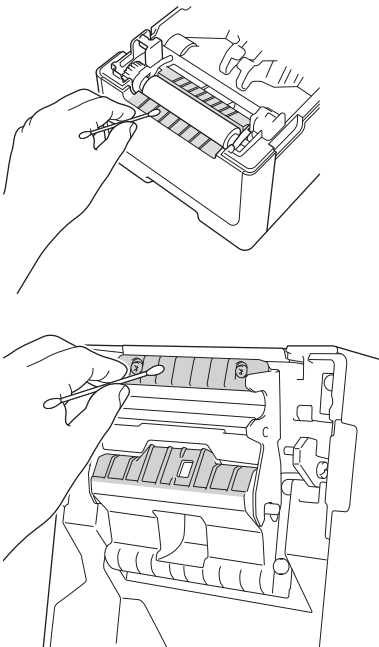

Clean the Label Exit Slot and the Roller of Linerless Models

- If adhesive residue gets attached to the Label Exit Slot, it may cause label jams. Use the adhesive side of a Label to remove the dust or stains from the Label Exit Slot.
- The Roller may need cleaning if the print quality is poor. Use the adhesive side of a Label to remove the dust or stains from the Roller.

We recommend cleaning the Label Exit Slot and the Roller when changing the label roll.

NOTE

Always remove the ejected labels from the Label Exit Slot. If the slot becomes blocked, label jams may occur.

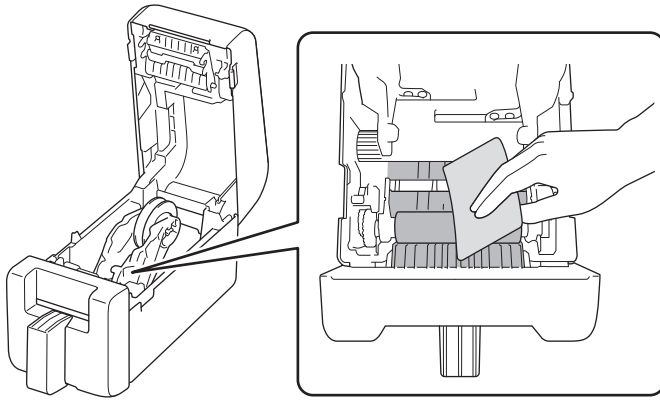

Clean the Roller

Wipe the roller with a lint-free cloth lightly moistened with isopropyl alcohol or ethanol. After cleaning the roller, make sure that no lint or other material remains on the roller.

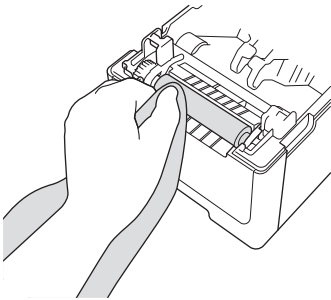

Use isopropyl alcohol or ethanol according to the manufacturer's safety guidelines, as applicable.

Clean the Print Head

Wipe the Print Head with a lint-free cloth or cotton swab lightly moistened with isopropyl alcohol or ethanol. We recommend cleaning the Print Head monthly.

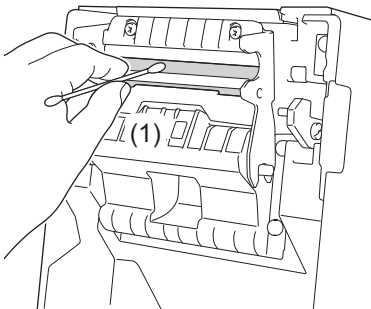

IMPORTANT

DO NOT touch the Print Head directly with bare hands to prevent electrostatic discharge and corrosion.



- Use isopropyl alcohol or ethanol according to the manufacturer's safety guidelines, as applicable.
- DO NOT clean the small clear window on the sensor (1).
- Cleaning the platen roller with solutions or abrasive materials will damage and may shorten the service life of the platen roller.

Clean the Print Head of Linerless Models

Wipe the Print Head with a lint-free cloth or cotton swab lightly moistened with isopropyl alcohol or ethanol. We recommend cleaning the Print Head when changing the label roll.

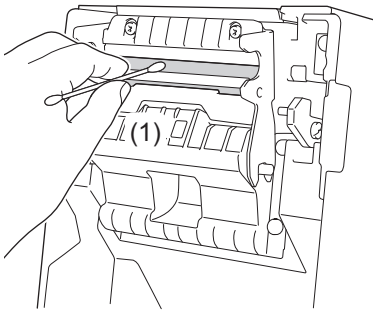

IMPORTANT

DO NOT touch the Print Head directly with bare hands to prevent electrostatic discharge and corrosion.



- Use isopropyl alcohol or ethanol according to the manufacturer's safety guidelines, as applicable.
- DO NOT clean the small clear window on the sensor (1).

Clean the Roll Guides

Wipe the Roll Guides with a lint-free cloth lightly moistened with isopropyl alcohol or ethanol.

We recommend cleaning the Roll Guides when changing the label roll.

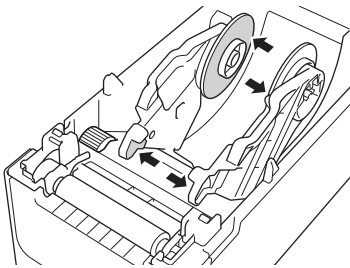

- Use isopropyl alcohol or ethanol according to the manufacturer's safety guidelines, as applicable.

Clean the Label Support

Wipe the Label Support with a lint-free cloth lightly moistened with isopropyl alcohol or ethanol.

We recommend cleaning the Label Support when changing the label roll.

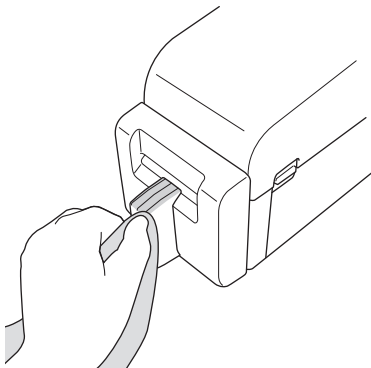

- Use isopropyl alcohol or ethanol according to the manufacturer's safety guidelines, as applicable.

Clean the Label Peeler

1. Wipe the roller with a lint-free cloth lightly moistened with isopropyl alcohol or ethanol. After cleaning the roller, make sure that no lint or other material remains on the roller.

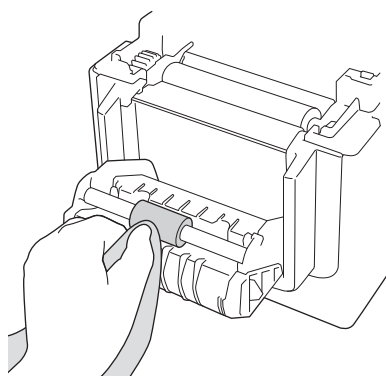

Use isopropyl alcohol or ethanol according to the manufacturer's safety guidelines, as applicable.

2. If adhesive residue gets on the Label Output Slot, it may cause label jams. Clean the Label Output Slot with a dry cotton swab.

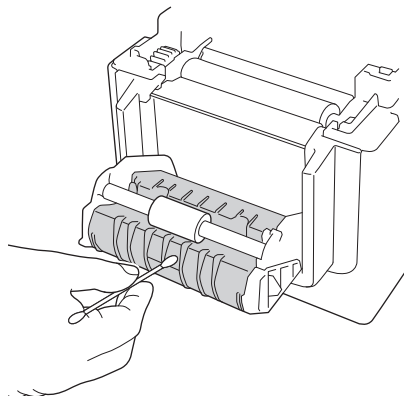

✓ Related Information

- [Routine Maintenance](#)
-

Replace the Coin Cell Battery

Related Models: TD-2320D/TD-2350D/TD-2320DF/TD-2350DF/TD-2320DSA/TD-2350DSA

A coin cell battery is used as a backup power supply to maintain the settings for the internal clock. Battery power is consumed even if the printer is not in use.

- Remove the battery if you do not intend to use the printer for an extended period of time.
- We recommend replacing the battery every two years. Some coin cell batteries have a short life span, and depending on the battery purchased, you may need to replace it sooner than two years. Replacing the battery is necessary according to its life span.
- If the coin cell battery runs out, the printer will print an incorrect date and time.
- If the clock is reset while power is supplied to the machine, replace this battery. When replacing the battery, use a CR2032 Coin Cell battery.
- Dispose of the battery at an appropriate collection point, not in the general waste stream. Be sure to observe all applicable local regulations.

IMPORTANT

- Use only recommended batteries. Other batteries may cause damage to the printer.
- When storing a battery, wrap it with cellophane tape to prevent it from short-circuiting.

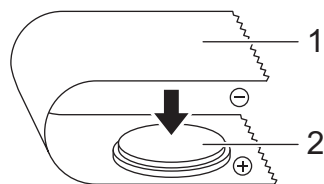

1. Cellophane tape
2. Coin cell battery



After a new coin cell battery is installed, the printer may display the message [Button battery low. The clock will reset soon.] If this message appears, you can continue using the printer. This message is transient and will not reappear.

1. Disconnect the printer from the electrical socket.
2. Turn the printer over.

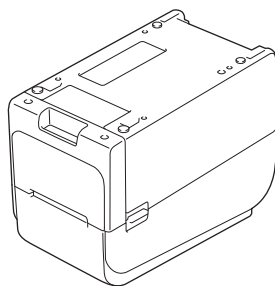

3. Remove the front cover base using a phillips screwdriver.

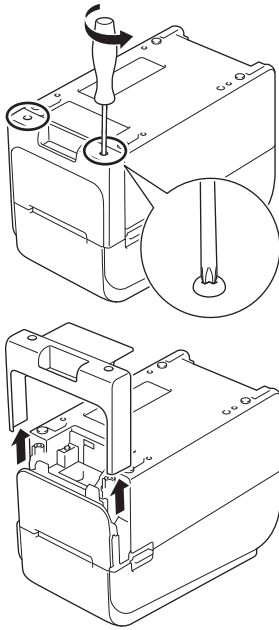

4. Press the right side of the battery and remove the battery as shown in the illustration.

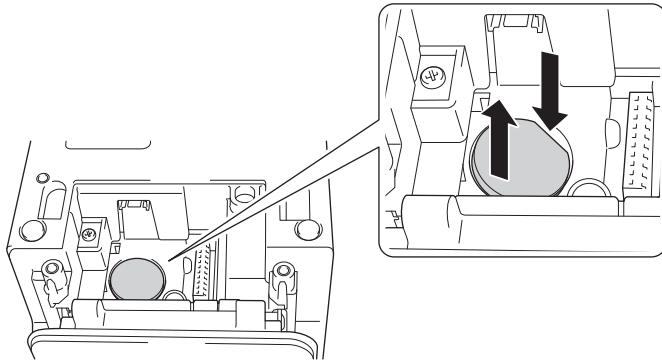

5. Insert the new battery into the battery slot, making sure the battery is level and its positive side is facing up.

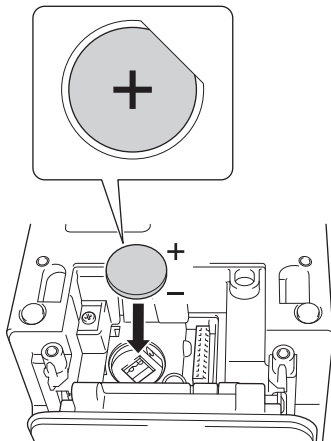

6. Reattach the front cover base using a phillips screwdriver.

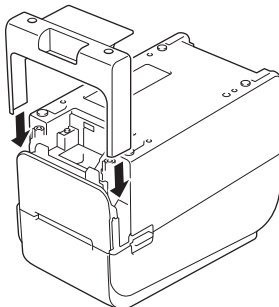

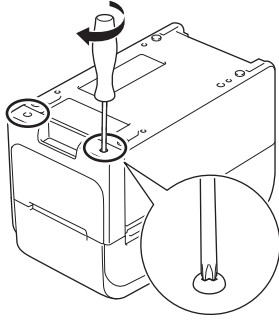

7. Reconnect the AC Power Cord to an electrical socket.



Related Information

- [Routine Maintenance](#)

Related Topics:

- [Set the Date and Time](#)
-

Replace the Parts

The Print Head, Platen Roller, and Cutter will wear during the life of the printer and may need replacement depending on different factors such as media type and volume printed. Tracking the print distance and cutter counts can be used as a guide for predicting future replacement timing. Cutter sharpness is also affected by factors other than the number of cuts.

Use the following methods to check the replacement period:

- Print and confirm by printing the Printer Settings Report using keys or menu.
For more information, see *Related Topics: Confirm Printer Settings*.
- Confirm the printer information using the Printer Setting Tool.
Start the **Printer Setting Tool**, and then select **Device Settings > Maintenance > Check Printer Information** to view the printer information.
- Print and confirm by printing the printer information using the Printer Setting Tool.
Start the **Printer Setting Tool**, and then select **Device Settings > Maintenance > Print Unit Settings** to print.
- Confirm part replacements through BRAdmin Professional.
To download BRAdmin Professional 4 software (Windows only), go to support.brother.com.
Add the number of cuts and total print length in the information displayed in the device list.



Related Information

- [Routine Maintenance](#)

Related Topics:

- [Confirm Printer Settings](#)

Check the Print Head

Regularly checking the Print Head's condition can help maintain good print quality.

>> [TD-2310D/TD-2320D/TD-2350D/TD-2320DF/TD-2350DF/TD-2320DSA/TD-2350DSA](#)

>> [TD-2350D/TD-2350DF/TD-2320DSA/TD-2350DSA](#)

TD-2310D/TD-2320D/TD-2350D/TD-2320DF/TD-2350DF/TD-2320DSA/TD-2350DSA

To check the Print Head's condition using the Printer Setting Tool (Windows), follow these steps:

1. Start the Printer Setting Tool.
Click **Start > Brother > Printer Setting Tool**.
2. Click **Device Settings**.
3. Click **Management > Print Head Check When Powered On**.
4. Select **On**.
5. Click **Apply**.
6. Turn the printer off and then turn the printer on.
7. Start the Printer Setting Tool.
Click **Start > Brother > Printer Setting Tool**.
8. Click **Device Settings**.
9. Click **Maintenance > Check Printer Information**.
10. Check **head_disconnection_count** in the **Check Printer Information** window.
11. If the value of **head_disconnection_count** is other than zero, print the print pattern you are using.
 - If there is no problem with the print quality, continue to use it.
 - If there is any print quality problem, replace the Print Head.

TD-2350D/TD-2350DF/TD-2320DSA/TD-2350DSA

To check the Print Head's condition, follow these steps:

1. Turn the printer on.
2. Press **Menu**.
3. Press **▲** or **▼** to select the following:
 - a. Select [Administration]. Press **OK**.
 - b. Select [Print Head Check]. Press **OK**.The printer will show the results of the Print Head check.
4. Press **OK** to return to the menu.
5. If there is any problem with the results, print the print pattern you are using.
 - If there is no problem with the print quality, continue to use it.
 - If there is any print quality problem, replace the Print Head.



Related Information

- [Routine Maintenance](#)

Troubleshooting

- [If You Are Having Difficulty with Your Machine](#)
- [Error and Maintenance LEDs](#)
- [Error and Maintenance Messages](#)
- [Printing Problems](#)
- [Version Information](#)
- [Reset the Printer](#)

If You Are Having Difficulty with Your Machine

This chapter explains how to resolve typical problems you may encounter when using the printer. If you have any problems with the printer, first make sure you have performed the following tasks correctly:

- Connect the printer to an electrical socket. For more information, see *Related Information*.
- Connect the AC Adapter. For more information, see *Related Information*.
- Remove all protective packaging from the printer.
- Install and select the correct printer driver. For more information, see *Related Topics*.
- Connect the printer to a computer or mobile device. For more information, see *Related Information*.
- Close the Roll Compartment Cover completely.
- Insert the media correctly. For more information, see *Related Information*.

If you still have problems, see *Related Information*. If after reading the topics you are unable to resolve the problem, visit the Brother support website at support.brother.com.



Related Information









- [Troubleshooting](#)

Related Topics:

- [Connect the Power Cord](#)
- [Install Printer Drivers and Software on a Computer](#)
- [Connect the Printer to a Computer](#)
- [Load a Media Roll](#)

Error and Maintenance LEDs

The LEDs light and flash to indicate the printer's status.















 or  or 	LED is lit in the colour shown.
 or  or 	LED is flashing in the colour shown.
	LED can be off, lit, or flashing in any colour.
	LED is off.























>> TD-2310D/TD-2320D/TD-2320DF

>> TD-2350D/TD-2350DF

>> TD-2320DSA/TD-2350DSA



















TD-2310D/TD-2320D/TD-2320DF























Power LED	Roll LED	Status LED	Condition	Action
			The Roll Compartment Cover is open.	Close the Roll Compartment Cover until it locks into place.
	 Repeat (1 second off, 1 second on)	 Repeat (1 second off, 1 second on)	Feed errors	<ol style="list-style-type: none"> Open the Roll Compartment Cover. Place the correct media in the printer. Confirm the media is correctly placed in the media path and correctly positioned relative to the sensors. Close the Roll Compartment Cover until it locks into place. Press  to clear the error. Press and hold  to turn the printer off.
			Media end error	
	 Repeat (1 second off, 1 second on)	 Repeat (1 second off, 1 second on)	Communication command error	Do one of the following: <ul style="list-style-type: none"> Open and close the Roll Compartment Cover. Press and hold  or press any key other than  and . Press and hold  to turn the printer off.
			BLF file error	
			Database search error	
			No template error	
			Time acquisition error	
			Access point search error	
			Access point connection error	
			Maximum print length over	
			ESC/P memory full error	
			JPEG file error	
USB host memory full error				

Power LED	Roll LED	Status LED	Condition	Action
		 Repeat (1 second off, 1 second on)	Data update incomplete error (network) Data update incomplete error (USB) Firmware update incomplete error High temperature error	Do one of the following: <ul style="list-style-type: none"> Open and close the Roll Compartment Cover. Press and hold  or press any key other than  and . Press and hold  to turn the printer off.
		 Repeat (0.9 seconds off, 0.3 seconds on, 0.3 seconds off, 0.3 seconds on)	Cutter error Mass storage error Print Head not detected Battery error Incorrect Option assembled Charge required	Press and hold  to turn the printer off. Connect the AC Adapter.
 Three times (0.5 seconds off, 0.5 second on)	 Three times (0.5 seconds off, 0.5 second on)	 Three times (0.5 seconds off, 0.5 second on)	The coin cell battery has no charge or is not installed.	Replace or install the coin cell battery.
 Three times (0.5 seconds off, 0.5 seconds on)	 Three times (0.5 seconds off, 0.5 seconds on)	 Three times (0.5 seconds off, 0.5 seconds on)	There might be a problem with the Print Head connection.	Print the print pattern you are using. <ul style="list-style-type: none"> If there is no problem with the print quality, continue to use it. If there are any print quality problems, replace the Print Head.
 Repeat (0.3 seconds off, 0.3 second on)	 Repeat (0.3 seconds off, 0.3 second on)	 Repeat (0.3 seconds off, 0.3 second on)	System error	Contact Brother customer service.
 Repeat (0.9 seconds off, 0.3 second on) Repeat (0.9 seconds off, 0.3 second on, 0.3 seconds off, 0.3 second on, 0.3 seconds off, 0.3 second on, 0.3 seconds off, 0.3 second on) Repeat (0.9 seconds off, 0.3 second on)	 Repeat (0.9 seconds off, 0.3 second on) Repeat (0.9 seconds off, 0.3 second on, 0.3 seconds off, 0.3 second on, 0.3 seconds off, 0.3 second on, 0.3 seconds off, 0.3 second on) Repeat (0.9 seconds off, 0.3 second on)	 Repeat (0.9 seconds off, 0.3 second on) Repeat (0.9 seconds off, 0.3 second on, 0.3 seconds off, 0.3 second on, 0.3 seconds off, 0.3 second on, 0.3 seconds off, 0.3 second on) Repeat (0.9 seconds off, 0.3 second on, 0.3 seconds off, 0.3 second on, 0.3 seconds off, 0.3 second on, 0.3 seconds off, 0.3 second on)	System error	Contact Brother customer service.

Power LED	Roll LED	Status LED	Condition	Action
on, 0.3 seconds off, 0.3 second on, 0.3 seconds off, 0.3 second on, 0.3 seconds off, 0.3 second on)	on, 0.3 seconds off, 0.3 second on, 0.3 seconds off, 0.3 second on, 0.3 seconds off, 0.3 second on)	seconds off, 0.3 second on)		











TD-2350D/TD-2350DF









Power LED	Roll LED	Status LED	Condition	Action
			The Roll Compartment Cover is open.	Close the Roll Compartment Cover until it locks into place.
			Network setting error SSID input/out of setting range error Password input/out of setting range error Wrong password error Out of setting range error Database size error	Press and hold  to clear the error.
	 Repeat (1 second off, 1 second on)	 Repeat (1 second off, 1 second on)	Feed errors Media end error	<ol style="list-style-type: none"> 1. Open the Roll Compartment Cover. 2. Place the correct media in the printer. 3. Confirm the media is correctly placed in the media path and correctly positioned relative to the sensors. 4. Close the Roll Compartment Cover until it locks into place. 5. Press  to clear the error. 6. Press and hold  to turn the printer off.
		 Repeat (1 second off, 1 second on)	Communication command error BLF file error Database search error No template error Time acquisition error Access point search error Access point connection error	<p>Do one of the following:</p> <ul style="list-style-type: none"> • Open and close the Roll Compartment Cover. • Press and hold  or press any key other than  and . • Press and hold  to turn the printer off.

Power LED	Roll LED	Status LED	Condition	Action
		 Repeat (1 second off, 1 second on)	Maximum print length over ESC/P memory full error JPEG file error USB host memory full error Data update incomplete error (network) Data update incomplete error (USB) Firmware update incomplete error High temperature error	Do one of the following: <ul style="list-style-type: none"> Open and close the Roll Compartment Cover. Press and hold  or press any key other than  and . Press and hold  to turn the printer off.
		 Repeat (0.9 seconds off, 0.3 seconds on, 0.3 seconds off, 0.3 seconds on)	Cutter error Mass storage error USB host power supply over error USB host non-compliant device connection error Print Head not detected Battery error Incorrect Option assembled Charge required	Press and hold  to turn the printer off. Connect the AC Adapter.
		 Repeat (0.9 seconds off, 0.3 seconds on, 0.3 seconds off, 0.3 seconds on, 0.3 seconds off, 0.3 seconds on)	USB hub connected	Press and hold  to turn the printer off, and then press  restart the printer.
 Repeat (0.3 seconds off, 0.3 second on)	 Repeat (0.3 seconds off, 0.3 second on)	 Repeat (0.3 seconds off, 0.3 second on)	System error	Contact Brother customer service.
 Repeat (0.9 seconds off, 0.3 second on) Repeat (0.9 seconds off, 0.3 second on, 0.3 second on, 0.3 second on)	 Repeat (0.9 seconds off, 0.3 second on) Repeat (0.9 seconds off, 0.3 second on, 0.3 second on, 0.3 second on)	 Repeat (0.9 seconds off, 0.3 second on) Repeat (0.9 seconds off, 0.3 second on, 0.3 seconds off, 0.3 second on, 0.3 seconds off, 0.3 second on)	System error	Contact Brother customer service.

Power LED	Roll LED	Status LED	Condition	Action
seconds off, 0.3 second on, 0.3 seconds off, 0.3 second on) Repeat (0.9 seconds off, 0.3 second on, 0.3 seconds off, 0.3 second on, 0.3 seconds off, 0.3 second on, 0.3 seconds off, 0.3 second on)	seconds off, 0.3 second on, 0.3 seconds off, 0.3 second on) Repeat (0.9 seconds off, 0.3 second on, 0.3 seconds off, 0.3 second on, 0.3 seconds off, 0.3 second on, 0.3 seconds off, 0.3 second on)	Repeat (0.9 seconds off, 0.3 second on, 0.3 seconds off, 0.3 second on, 0.3 seconds off, 0.3 second on, 0.3 seconds off, 0.3 second on)		

TD-2320DSA/TD-2350DSA

Power LED	Condition	Action
	The Roll Compartment Cover is open.	Close the Roll Compartment Cover until it locks into place.
	Network setting error	Press and hold  to clear the error.
	SSID input/out of setting range error	
	Password input/out of setting range error	
	Wrong password error	
	Out of setting range error	
	Database size error	
	Feed errors	<ol style="list-style-type: none"> 1. Open the Roll Compartment Cover. 2. Place the correct media in the printer. 3. Confirm the media is correctly placed in the media path and correctly positioned relative to the sensors. 4. Close the Roll Compartment Cover until it locks into place. 5. Press  to clear the error. 6. Press and hold  to turn the printer off.
	Media end error	
	Communication command error	Do one of the following: <ul style="list-style-type: none"> • Open and close the Roll Compartment Cover. • Press and hold  or press any key other than  and . • Press and hold  to turn the printer off.
	BLF file error	
	Database search error	
	No template error	
	Time acquisition error	
	Access point search error	
	Access point connection error	

Power LED	Condition	Action
	Maximum print length over	Do one of the following: <ul style="list-style-type: none"> • Open and close the Roll Compartment Cover. • Press and hold  or press any key other than ▲ and ▼. • Press and hold  to turn the printer off.
	ESC/P memory full error	
	JPEG file error	
	USB host memory full error	
	Data update incomplete error (network)	
	Data update incomplete error (USB)	
	Firmware update incomplete error	
	High temperature error	
	Cutter error	Press and hold  to turn the printer off.
	Cutter error	
	Mass storage error	
	USB host power supply over error	
	USB host non-compliant device connection error	
	Print Head not detected	
	Battery error	
	Incorrect Option assembled	
	Charge required	Connect AC Adapter.
USB hub connected	Press and hold  to turn the printer off, and then press  restart the printer.	
 Repeat (0.3 seconds off, 0.3 second on)	System error	Contact Brother customer service.
 Repeat (0.9 seconds off, 0.3 second on) Repeat (0.9 seconds off, 0.3 second on, 0.3 seconds off, 0.3 second on, 0.3 seconds off, 0.3 second on) Repeat (0.9 seconds off, 0.3 second on, 0.3 seconds off, 0.3 second on, 0.3 seconds off, 0.3 second on, 0.3 seconds off, 0.3 second on)	System error	Contact Brother customer service.



Related Information

- [Troubleshooting](#)
-

Error and Maintenance Messages

Related Models: TD-2350D/TD-2350DF/TD-2320DSA/TD-2350DSA

Message	Solution
Button battery low. The clock will reset soon.	Replace the coin cell battery immediately as printing with the correct time will no longer be possible. This message may appear after replacing the battery. If this message appears, you can continue using the printer. This message is transient and will not reappear. For more information , see <i>Related Topics: Replace the Coin Cell Battery</i> .
Database size error	The maximum size of an editable database is 500 lines or less and 1MB or less.



Related Information

- [Troubleshooting](#)





Related Topics:

- [Replace the Coin Cell Battery](#)

Printing Problems

Printing Problems

Problem	Solution
<p>The LED or the LCD is not lit. (TD-2350D/TD-2350DF/TD-2320DSA/TD-2350DSA)</p> <p>The LED is not lit. (TD-2310D/TD-2320D/TD-2320DF)</p>	<ul style="list-style-type: none"> Is the AC adapter cord connected correctly? Check the cord is connected correctly. TD-2350D/TD-2350DF/TD-2320DSA/TD-2350DSA: If the LED or the LCD still does not light up, contact Brother customer service. TD-2310D/TD-2320D/TD-2320DF: If the LED still does not light up, contact Brother customer service.
<p>The printer does not print, or a printing error is received.</p>	<ul style="list-style-type: none"> Is the cable loose? Make sure the cable is connected securely. Is the media roll installed correctly? If not, remove the media roll and reinstall it. Has the media roll run out? Install a new media roll. Is the Roll Compartment Cover open? Make sure the Roll Compartment Cover is closed. Has a print error or transmission error occurred? Turn the printer off, and then turn it on again. If there is still a problem, contact Brother customer service. If the printer is connected via a USB hub, try connecting it directly to the computer. If not, try connecting it to another USB port.
<p>A data transmission error appears on the computer.</p>	<ul style="list-style-type: none"> Is the correct port selected? Make sure the correct port is selected. Is the printer in cooling mode? If the Power LED lights in green and the Status LED is flashing in orange, wait until the Status LED stops flashing, and then try printing again. Are there any unfinished print jobs? If you try to print while other users are printing large amounts of data, the printer is unable to accept your print job until the current print jobs are completed. If this occurs, send the print job again after the other jobs are completed.
<p>I want to cancel the current printing job.</p>	<p>Press  while printing is paused.</p>
<p>The print quality is poor.</p>	<p>Is there dust or dirt on the printer parts preventing it from their proper work? Clean around the Roller, Print Head, the side of Roll Guide, and Label Support. For more information, see <i>Related Information</i>.</p> <p>Adjust the Energy Rank from the Paper Size Setup tool or adjust the Print Speed from the Device Settings tool. For more information, see <i>Related Information</i>.</p>
<p>I want to increase the print density.</p>	<p>From the Paper Size Setup tool, go to the New and Advanced Printing Adjustments, and then increase the Energy Rank. For more information, see <i>Related Information</i>.</p>
<p>The printer does not feed paper.</p>	<ul style="list-style-type: none"> Is there dirt or lint on the roller preventing it from rotating freely? Clean the roller. For more information, see <i>Related Information</i>. Make sure the ejection path of the paper is not blocked. Remove the media roll and install it again. For more information, see <i>Related Information</i>. Make sure the Roll Compartment Cover is closed completely.

Problem	Solution
The printer feeds paper continuously.	<ul style="list-style-type: none"> • Open the Roll Compartment Cover. • Press any button to stop feeding. <p>Press  while printing is paused to cancel the print job.</p> <p>TD-2350D/TD-2350DF/TD-2320DSA/TD-2350DSA: Press any button except for , , or  while printing is paused to resume printing.</p> <p>TD-2310D/TD-2320D/TD-2320DF: Press any button except for  while printing is paused to resume printing.</p>
The printer does not pause between labels.	<ul style="list-style-type: none"> • Make sure you entered the media information correctly. You can set the media information using Paper Size Setup in the Printer Setting Tool. • If the sensor is dirty, wipe it with a dry cotton swab. • Make sure there are no items blocking the sensor.
An error occurs when the roll cannot be fed to the beginning of the printing.	<p>If a feed error occurs, use the Paper Size Setup of the Printer Setting Tool to assign the correct paper settings to the printer.</p> <p>TD-2350D/TD-2350DF/TD-2320DSA/TD-2350DSA: Press Menu, and then press Media > Selection to check whether the correct media is set in the printer when a Media roll is used.</p>
Head, motor, or Rechargeable Li-ion Battery is cooling down.	<p>The thermal head, motor, or Rechargeable Li-ion Battery is too hot.</p> <p>Head:</p> <p>The printer stops and resumes printing only after the thermal head has cooled down. The head may become too hot if you are printing a large number of documents with high text content. If the thermal head becomes too hot, it may produce imaging on the paper in areas not intended to be printed. To avoid or delay this condition, print using a lighter density setting, reduce the amount of black space being printed (for example, remove background shading and colors in graphs and presentation documents), and make sure that the printer has adequate ventilation and is not located in an enclosed space.</p> <p>Motor or Rechargeable Li-ion Battery:</p> <p>Do not use the printer continuously. If the printer is used continuously, the motor or Rechargeable Li-ion Battery will become too hot. In this case, the printer will stop and resume printing after the motor or Rechargeable Li-ion Battery has cooled down.</p> <div style="background-color: #e6f2ff; padding: 5px; margin-top: 10px;"> <p>NOTE</p> <p>This condition may occur more often when the printer is used at high altitude (more than 3,048 m) due to a lower air density available to cool the printer.</p> </div>
I want to reset the printer/delete the data transferred from the computer.	See <i>Related Information</i> .
Print Head cannot be attached.	The Print Head cannot be attached if the Print Head spring is sticking out. Place the Print Head spring correctly and try again.
The media is not ejected correctly when using the optional label peeler.	<p>Has the sensor of the label peeler been exposed to direct sunlight?</p> <p>If the sensor of the label peeler has been exposed to direct sunlight, loaded media may not be detected correctly. Use the printer in a location not exposed to direct sunlight.</p>

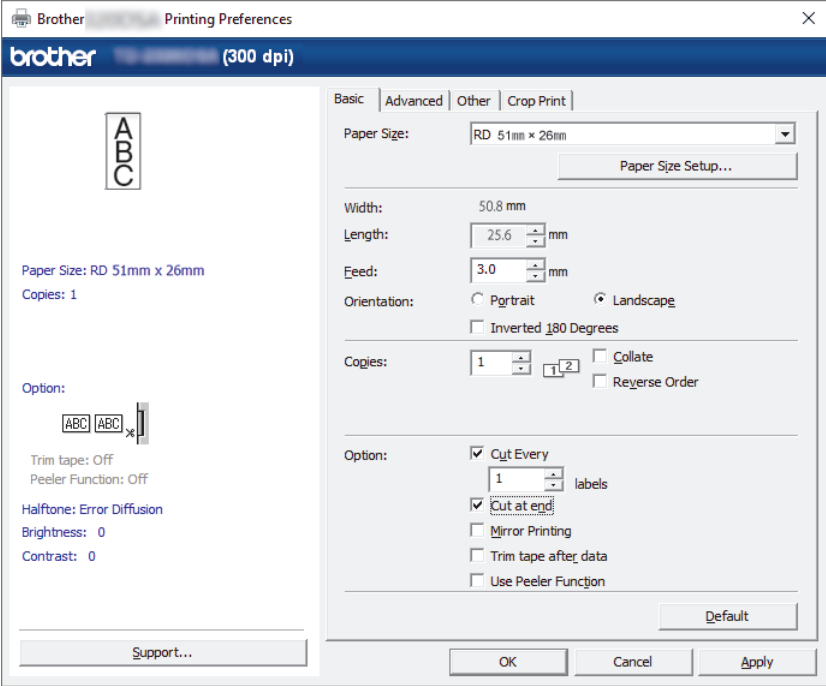
Problem	Solution
<p>Barcodes printed using applications other than P-touch Editor cannot be read.</p>	<p>If the barcode data was created using a landscape orientation, change the Orientation setting in the Basic tab of the printer driver to Landscape and try again.</p> 
<p>Wrinkles appear on the printed label. (TD-2320DF/TD-2350DF)</p>	<p>Is media roll adhesive adhered to the Roll Guide? Readjust the position of the Roll Guide using the adjuster dial, following the <i>Load Media Roll</i> instruction. For more information, see <i>Related Information</i>.</p>
<p>Printed labels are getting jammed. (TD-2320DF/TD-2350DF)</p>	<ul style="list-style-type: none"> • Is there dirt, lint, or roll adhesive stuck to the printer parts, preventing free roll feeding? Clean around the Roller, Print Head, and the side of Roll Guides. For more information, see <i>Related Information</i>. • Is the media roll correctly wound? Remove the media roll and replace it with a new one. If the labels continuously become stuck or jammed in the printer, the Platen Roller may be worn and needs to be replaced. For more information, see <i>Related Information</i>.

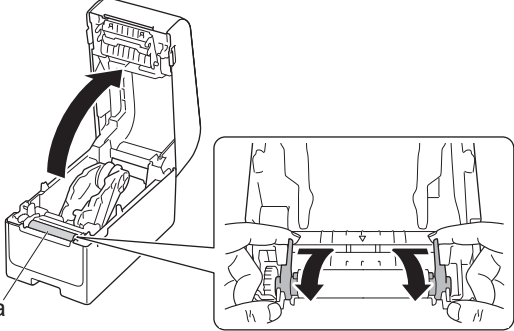
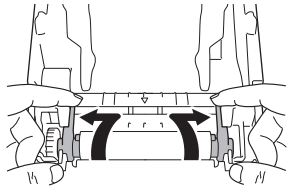
Problem	Solution
<p>The media is entangled around the Platen Roller.</p>	<p>Remove the media from the Platen Roller.</p> <ol style="list-style-type: none"> 1. Open the Roll Compartment Cover and unlock the lever of both sides of the Platen Roller and lift it up.  <p>a. Platen Roller</p> <ol style="list-style-type: none"> 2. Remove the entangled media from the Platen Roller. 3. Put the Platen Roller back and pull down the levers and close the Roll Compartment Cover. 
<p>When printing is executed while using the USB power delivery function, the printer enters the cooling mode and cannot start printing.</p>	<ul style="list-style-type: none"> • Make sure that the main unit and the device are connected with a USB-C to USB-C cable. • The printer is hot and cooling down. Printing will restart once it cools down.

Printed Image Problems

Problem	Solution
<p>Printed paper contains streaks or poor quality characters, or paper is not fed correctly.</p>	<p>Is the Print Head or Roller dirty?</p> <p>Although the Print Head generally remains clean under normal use, lint or dirt from the roller may become stuck on the printer head. If this occurs, clean the roller. For more information, see <i>Related Information</i>.</p>

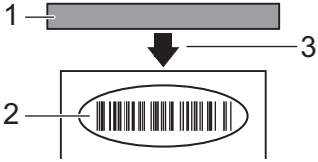
Problem	Solution
Printed barcodes cannot be read.	<ul style="list-style-type: none"> Print labels so that barcodes are aligned with the Print Head as shown below: <div style="text-align: center;">  </div> <ol style="list-style-type: none"> Print Head Barcodes Printing orientation Barcodes may not be read if they are reduced or enlarged. Try using another scanner. Change settings in the Printer Setting Tool. <ol style="list-style-type: none"> Start the Printer Setting Tool. Click Device Settings and try the following settings: <ul style="list-style-type: none"> Select a slower option in the Print Speed setting. Adjust the Print Density setting. Adjust the Energy Rank setting in the Paper Size Setup menu, if necessary. Change settings from the control panel. <ol style="list-style-type: none"> Press Menu, enter the Settings menu, and try the following settings: <ul style="list-style-type: none"> Select a slower speed in the Print Speed setting. Select a darker setting in the Print Density setting.

Network Problems (TD-2320D/TD-2350D/TD-2320DF/TD-2350DF/TD-2320DSA/TD-2350DSA)

Problem	Solution
You are using security software.	<ul style="list-style-type: none"> Confirm your settings in the installation dialog box. Allow access when the security software alert message appears during the printer installation.
Your security settings (SSID/ Network Key) are incorrect. (TD-2350D/TD-2350DF/ TD-2350DSA)	<p>Recheck and select the correct security settings.</p> <ul style="list-style-type: none"> The manufacturer's name or model number of the wireless access point/ router may be used as the default security settings. See the instructions supplied with your wireless access point/router for information on how to find the security settings. Contact the wireless access point/router manufacturer, Internet provider, or network administrator.
Your printer cannot connect to the host device using Wi-Fi or Bluetooth. (TD-2350D/ TD-2350DF/TD-2350DSA)	<ul style="list-style-type: none"> Move your printer within about one metre of the mobile device when you configure the Wi-Fi network settings. Move your printer to an obstruction-free area.
Your printer cannot print using Wi-Fi or Bluetooth. (TD-2350D/ TD-2350DF/TD-2350DSA)	<ul style="list-style-type: none"> If a wireless computer, Bluetooth-equipped device, microwave oven, digital cordless phone, or other device is near your printer or the wireless access point/router, move the device away from your printer or wireless access point/ router.
There are obstructions (walls or furniture, for example) between your printer and the mobile device. (TD-2350D/TD-2350DF/ TD-2350DSA)	<p>Move your printer to an obstruction-free area.</p>
You are using MAC Address filtering.	<p>You can confirm the MAC address by printing the Printer Settings Report. For more information, see <i>Related Information</i>.</p>
Your printer is not connected correctly to the network.	<ul style="list-style-type: none"> Make sure the printer is in the mode you want to connect to. If the printer is still not connected, do the following:

Problem	Solution
	<ul style="list-style-type: none"> - For Wi-Fi connection (TD-2350D/TD-2350DF/TD-2350DSA)  : Your printer is searching for a wireless network. Wait until the search is complete. - For Wireless Direct (TD-2350D/TD-2350DF/TD-2350DSA) If the Wireless Direct icon is displayed on the LCD, search for the printer from the device you want to connect. - For Wired LAN Make sure the LAN cable is connected correctly. - For Bluetooth (TD-2350D/TD-2350DF/TD-2350DSA) If the Bluetooth icon is displayed on the LCD, search for the printer from the device you want to connect.
I have checked and tried all of the above, but still cannot set the Wi-Fi/Bluetooth function. (TD-2350D/TD-2350DF/TD-2350DSA)	Turn the printer off, and then turn it on again. Then, configure the Wi-Fi and Bluetooth settings again.
Your printer is not connected if the Bluetooth connection with an Apple device (iPad, iPhone, or iPod touch) is lost. (TD-2350D/TD-2350DF/TD-2350DSA)	Turn the Auto Reconnect function on. You can set it from the Printer Setting Tool. For more information, see <i>Related Information</i> . TD-2350D/TD-2350DF/TD-2320DSA/TD-2350DSA: You can also set it using the Bluetooth menu on the printer's LCD.
Your printer is not assigned with an available IP address.	<ul style="list-style-type: none"> • Confirm the IP address and the Subnet Mask. Verify both the IP addresses and Subnet Masks of your computer and your printer are correct and located on the same network. For more information on how to verify the IP address and the Subnet Mask, contact your network administrator. • Confirm your IP address, Subnet Mask and other network settings using the Printer Setting Tool. For more information, see <i>Related Information</i>. TD-2350D/TD-2350DF/TD-2320DSA/TD-2350DSA: You can also confirm network settings on the printer's LCD.
Your previous printing job was unsuccessful.	If an unfinished print job is still in your computer's print queue, delete it. For example, when using Windows 10: Click Start > Settings > Devices > Printers & scanners . Click the printer you want to set up, and then click Open queue . Click Printer > Cancel All Documents .
I have checked and tried all of the above, but my printer does not print.	Uninstall the printer driver and the software, and then reinstall them.
You did not select to allow access when the security alert dialog box appeared during the standard installation, or when printing.	If you did not select to allow access when the security alert dialog box appeared, the firewall function of your security software may be blocking access. Some security software may block access without displaying a security alert dialog box. To allow access, see your security software instructions or contact the manufacturer.

Other Problems

Problem	Solution
I want to prevent dates and times from being modified.	Set a passcode for the Administration menu to ensure security. For more information, see <i>Related Information</i> .
Unable to transfer template to printer.	The printer driver may not be correctly installed. Re-install the printer driver, and then try transferring again.

Problem	Solution
	<p>The printer has 8 MB or 32MB of built-in memory available, allowing a maximum of 255 templates to be saved. When there is no more of the built-in memory available or when 255 templates have been registered, templates can no longer be transferred to (be registered with) the printer. Delete unnecessary templates from the printer.</p> <p>Make sure the printer's LCD displays the Home screen (either the Template List Screen or the Template Touch Screen).</p>
<p>Cannot check the number of templates registered with the printer and their Key Assign numbers.</p>	<ol style="list-style-type: none"> 1. Connect the printer to the computer with a USB cable, and then turn the printer on. 2. Start P-touch Transfer Manager P-touch Transfer Manager is installed with P-touch Editor 5.4, which may be an earlier version of P-touch Editor than you are currently using. To download P-touch Editor 5.4, go to your model's FAQs & Troubleshooting page at support.brother.com. 3. Click the model name of your printer in the pane on the left side to display the templates registered with the printer in the pane on the right side. The number of templates and the Key Assign numbers that are being used can be checked. <p>For more information, see <i>Related Information</i>.</p>



Related Information

- [Troubleshooting](#)

Related Topics:

- [Clean Your Printer](#)
- [Printer Setting Tool \(Windows\): Paper Size Setup](#)
- [Printer Setting Tool \(Windows\): Device Settings](#)
- [Load a Media Roll](#)
- [Reset the Printer](#)
- [Confirm Printer Settings](#)
- [Printer Setting Tool: Communication Settings \(Windows\)](#)
- [Set the Menu Security](#)
- [Transfer a Template or Other Data from the Computer to the Printer \(Windows\)](#)

Version Information

Problem	Solution
I do not know the version number of the firmware for the printer.	You can confirm the version number of the firmware by printing the Printer Settings Report. For more information, see <i>Related Information</i> .
I want to confirm whether I am using the latest version of the software.	Use the P-touch Update Software to confirm whether you have the latest version. For more information about the P-touch Update Software, see <i>Related Information</i> .



Related Information

- [Troubleshooting](#)

Related Topics:

- [Confirm Printer Settings](#)
- [Update the Firmware](#)







Reset the Printer

- [Reset All Settings to the Factory Settings Using the Printer Buttons](#)
- [Reset Settings Using the LCD Menu](#)
- [Reset Data Using the Printer Setting Tool](#)

Reset All Settings to the Factory Settings Using the Printer Buttons

Related Models: TD-2310D/TD-2320D/TD-2320DF

Reset the internal memory of your printer to clear all the saved label files, or if the printer is not operating correctly.

1. Turn the printer off.
2. Press and hold  and  for about three seconds.
All LED indicators flash in red.
3. Continue holding down 
 - TD-2320D/TD-2320DF: Press  once to reset the network settings.
The Power LED lights in red.
 - TD-2320D/TD-2320DF: Press  twice to reset the transferred data and the device settings.
The Roll LED lights in red.
 - Press  three times to reset all the settings and device settings to the factory settings.
The Status LED lights in red.
4. Release 
All LED indicators flash red four times, and then light in red.



Related Information

- [Reset the Printer](#)

Reset Settings Using the LCD Menu

Related Models: TD-2350D/TD-2350DF/TD-2320DSA/TD-2350DSA

- >> [TD-2350D/TD-2350DF](#)
- >> [TD-2320DSA/TD-2350DSA](#)

TD-2350D/TD-2350DF

You can select the reset option using the LCD menu.

- Factory Reset
 - User Data Reset
 - Network Reset
1. Press **Menu**.
 2. Press **▲** or **▼** to select the following:
 - a. Select [Administration]. Press **OK**.
 - b. Select [Reset]. Press **OK**.
 - c. Select the reset option you want. Press **OK**.
 3. Press **▲** or **▼** to select [Reset]. Press **OK**.
The machine restarts.

TD-2320DSA/TD-2350DSA

You can select the reset option using the LCD menu.

- Factory Reset
 - User Data Reset
 - Network Reset
1. Press **Menu**.
 2. Press **▲** or **▼** to select the following:
 - a. Select [Administration]. Press **OK**.
 - b. Select [Reset]. Press **OK**.
 - c. Select the reset option you want. Press **OK**.
 3. Press **OK** to confirm.
The machine restarts.



Related Information

- [Reset the Printer](#)

Reset Data Using the Printer Setting Tool

Reset the internal memory of your printer to clear all the saved label files, or if the printer is not operating correctly.

You can use the Printer Setting Tool from a computer to perform the following operations for the printer:

- Delete the templates and databases
- TD-2320D/TD-2350D/TD-2320DF/TD-2350DF/TD-2320DSA/TD-2350DSA: Reset communication settings
- Reset printer settings to factory settings



Related Information

- [Reset the Printer](#)
-

Appendix

- [Specifications](#)
- [Software Development Kit](#)
- [LabelCLT](#)
- [Product Dimensions](#)
- [Auto Media Configuration](#)
- [Print History](#)
- [Options](#)
- [Brother Help and Customer Support](#)

Specifications

- >> [Printing](#)
- >> [Size](#)
- >> [Interface](#)
- >> [Environment](#)
- >> [Power Supply](#)
- >> [Media Specifications](#)
- >> [Rechargeable Li-ion Battery: Battery Level and Printed Capacity](#)
- >> [Compatible Operating Systems](#)

Printing

Printing Technology	Direct Thermal
Print Resolution	<ul style="list-style-type: none"> • TD-2310D/TD-2320DF/TD-2350DF 203 dpi • TD-2320D/TD-2350D/TD-2320DSA/TD-2350DSA 203 dpi / 300 dpi
Print Speed (depending on the media used)	Maximum 152.4 mm/s ¹
Maximum Print Width	59 mm
Maximum Print Length	3000 mm

¹ When using our printing test data <58 x 100 mm, print coverage 10%> and printing continuously using AC with USB connection in an environment with a temperature of 23°C.

Size

Weight	<ul style="list-style-type: none"> • TD-2310D Approximately 1.46 kg • TD-2320D Approximately 1.50 kg • TD-2350D Approximately 1.53 kg • TD-2320DF Approximately 1.79 kg • TD-2350DF Approximately 1.82 kg • TD-2320DSA Approximately 1.77 kg • TD-2350DSA Approximately 1.77 kg • TD-2350DSA (with Handle) Approximately 1.94 kg
Dimensions	<ul style="list-style-type: none"> • TD-2310D/TD-2320D/TD-2350D Approximately 119 mm (W) x 158 mm (H) x 224 mm (D) • TD-2320DSA/TD-2350DSA Approximately 119 mm (W) x 176 mm (H) x 224 mm (D) • TD-2350DSA (with Handle) Approximately 153 mm (W) x 176 mm (H) x 280 mm (D) • TD-2320DF/TD-2350DF Approximately 119 mm (W) x 158 mm (H) x 255 mm (D)

Interface

USB	USB Ver.2.0 (Full Speed) (Type C)
Serial	RS-232C (RJ25) ¹
Wired LAN (TD-2320D/TD-2350D/TD-2320DF/ TD-2350DF/TD-2320DSA/TD-2350DSA)	10/100BASE-TX
USB Host Port (TD-2320D/TD-2350D/ TD-2320DF/TD-2350DF/TD-2320DSA/ TD-2350DSA)	USB Ver.2.0 (Full Speed) (Type A)
Bluetooth (TD-2350D/TD-2350DF/ TD-2350DSA)	SPP, OPP, HCRP (Bluetooth Classic), GATT (Bluetooth Low Energy)
Wireless LAN (TD-2350D/TD-2350DF/ TD-2350DSA)	IEEE 802.11 b/g/n (Infrastructure Mode) IEEE 802.11 g/n (Wireless Direct mode)

¹ Use a dedicated conversion cable.

Environment

Operating Temperature	Printer	Between 5°C and 40°C
	Battery Charger	Between 10°C and 35°C
Operating Humidity	Printer	Between 20% and 80% (without condensation)
	Battery Charger	Maximum wet bulb temperature: 27°C

Power Supply

Adapter	Standard AC Adapter (100 - 240 V 50/60Hz), Medical AC Adapter (100 - 240 V 50/60Hz)
Recharging Time	Printer recharging: Approximately 2.2 hours ¹ Battery charger: Approximately 2.0 hours ¹
Battery Charge And Discharge Cycle Count	Approximately 300 cycles ²

¹ When the printer is turned off, a new Rechargeable Li-ion Battery is used, and charged at 23°C.

² At 23°C

Media Specifications

The media material may affect print quality.

Media Type	TD-2310D/TD-2320D/TD-2350D/TD-2320DSA/TD-2350DSA <ul style="list-style-type: none"> • Wristbands ¹ • Continuous • Die-Cut • Fanfold • Perforated • Tag ² TD-2320DF/TD-2350DF Linerless label
Media Width	TD-2310D/TD-2320D/TD-2350D/TD-2320DSA/TD-2350DSA From 15 mm to 63 mm ³ Wristbands: From 15 mm to 36 mm ^{3 4} TD-2320DF/TD-2350DF

	58mm, 39mm
Media Length	Continuous: From 6.4 mm to 3,000 mm Label Peeler: From 17 mm to 3,000 mm Cutter: From 20 mm to 3,000 mm Tear: From 18 mm to 3,000 mm
Thickness	TD-2310D/TD-2320D/TD-2350D/TD-2320DSA/TD-2350DSA From 0.058 mm to 0.279 mm ³ - Peel: From 0.083 mm to 0.130 mm ^{3 4} - Tearbar cut: From 0.058 mm to 0.083 mm ^{3 4} - Auto cut: From 0.075 mm to 0.279 mm ^{3 4} - Receipt: From 0.058 mm to 0.083 mm ^{3 4} - Label: From 0.104 mm to 0.178 mm ^{3 4} - Tag: From 0.133 mm to 0.190 mm ^{3 4} - Wristband: From 0.107 mm to 0.279 mm ^{3 4} TD-2320DF/TD-2350DF 0.068 mm, 0.086 mm, 0.095 mm
Roll Outside Diameter (maximum)	TD-2310D/TD-2320D/TD-2350D/TD-2320DSA/TD-2350DSA 127 mm TD-2320DF/TD-2350DF 80 mm, 102 mm
Core Diameter (minimum)	TD-2310D/TD-2320D/TD-2350D/TD-2320DSA/TD-2350DSA 12.7 mm TD-2320DF/TD-2350DF 25 mm
Media Sensor	Transmissive, Reflective
Media Roll Winding Direction	Both the outside and inside wound roll media can be used.

1 Depending on the shape of the wristband, black marks may not be detected by the Reflective/black mark Sensor.

2 Make sure you use correct media.

3 Based on catalogue specifications.

4 Values are based on Brother genuine media rolls and PDC wristbands. When exceeding the specified value, confirm the media yourself. The media materials may affect print width.

Rechargeable Li-ion Battery: Battery Level and Printed Capacity

The following number of pages can be printed, depending on the battery level.

- Tested at 23 °C using Brother's print test data 50 mm × 30 mm label with default print density and 11% coverage.
- These numbers represent continuous printing when connected via USB and using a new, fully charged battery. Note that the details listed below cannot be guaranteed because of the difference in printing conditions, operating environments, and battery condition.

Battery level: Full	Capable of printing approximately 13,000 labels
---------------------	---

Compatible Operating Systems

For the latest list of compatible software, visit support.brother.com.

Related Information

- [Appendix](#)

Software Development Kit

Software Development Kit (SDK) is available from the Brother Developer Center (<https://support.brother.com/g/s/es/dev/en/index.html>).

The b-PAC SDK and the SDKs for mobile devices (Android™, iPhone, and iPad) can also be downloaded. (The SDKs available are subject to change without notice.)



Related Information

- [Appendix](#)

LabelCLT

- [LabelCLT Overview](#)
- [Transfer the Template Data File with LabelCLT](#)
- [Transferring a PDZ Firmware File via USB: Example](#)

LabelCLT Overview

Overview

LabelCLT is a command line tool that allows you to transfer files and obtain status from the printer using the command line.

To download LabelCLT, go to your model's **Downloads** page on the Brother support website at support.brother.com.

Operating Environment

Supported Operating Systems

Windows only. For the latest list of supported Windows Operating Systems, visit support.brother.com.

Communication Interface

USB, Wired LAN, or Wireless LAN

File Types

File Type	Generated From	Supported Interfaces
BIN	Device Settings, Communication Settings, P-touch Template Settings, and Paper Size Setup	USB, LAN
PDZ	Firmware and P-touch Editor	USB
BLF	Device Settings, Communication Settings, P-touch Template Settings, Paper Size Setup, P-touch Editor, and LabelCLT	USB, LAN
CSV	Windows applications	USB, LAN
OTF	Font file types	USB
TTF		
PEM	File format used for security certificates.	USB



Related Information

- [LabelCLT](#)

Transfer the Template Data File with LabelCLT

For supported commands, usage examples, and errors not listed here, see the LabelCLT manual on the Brother support website at support.brother.com.

>> [Install LabelCLT](#)

>> [Basic File Transfer Procedure](#)

Install LabelCLT

1. Download LabelCLT to your computer.
2. Type "cmd" in the Windows search box to start the command prompt.
3. Type the drive where LabelCLT is saved and press Enter. (In this example, LabelCLT is saved on the "C" drive.)

```
J:\>c:
```

4. Type **cd**, add a space, and then copy and paste the path of the folder where the "LabelCLT.exe" file is located (in this example: **cd c:\LabelCLT**). Press Enter.

```
c:\>cd c:\LabelCLT
```

5. Type **LabelCLT.exe /eula** and press Enter to display the License Agreement. If you agree to the terms of the License Agreement, type "y" (for "yes") on your keyboard and press Enter.

Basic File Transfer Procedure

1. Access the printer using one of the commands below depending on your interface.

Command	Function	Example
/ip:"IP Address"	LAN: Specify IP or NodeName.	/ip:"192.168.0.250" or /ip:"BRW00AABBFF"
/printer:"Printer Name"	USB: Specify the printer name.	/printer:"Brother TD-2350D (300 dpi)"

2. Transfer files using commands below.

Command	Function	Example
/send_pdz:"FilePath"	Send the specified PDZ file	/printer:"Brother TD-2350D (300 dpi)" /send_pdz:"c:\test \a.pdz"
/send_blf:"FilePath"	Send the specified BLF file	/ip:"192.168.0.250" /send_blf:"c:\test\a.blf"
/send_bin:"FilePath"	Send the specified BIN file	/ip:"192.168.0.250" /send_bin:"c:\a.bin"
/send_csv:"FilePath"	Send the specified CSV file	/ip:"192.168.0.250" /send_csv:"c:\test\a.csv"



Related Information

- [LabelCLT](#)

Transferring a PDZ Firmware File via USB: Example

1. Specify the printer with the **LabelCLT.exe /printer** command, and specify the file to be transferred with the **/send_pdz** command, and then press Enter.

```
c:\LabelCLT>LabelCLT.exe /printer:"Brother TD-2350D (300 dpi)" /send_pdz:"c:\test\1a.pdz"
```

2. The transfer will start, and the transfer progress will be displayed.
3. When the transfer is complete, LabelCLT will wait until the printer finishes writing the firmware.
4. When the printer has finished writing the firmware, it will restart and LabelCLT will reconnect.
5. After reconnection, compare the transferred firmware version with the current printer firmware version.
6. If the update has been successfully completed, **Succeeded** is displayed.

Integration with the **Windows Task Scheduler** allows to implement instructions at specified times or on a regular basis.

1. Prepare a batch file with the command you want to implement - for example, check the firmware version.

```
cd/d %~dp0  
LabelCLT.exe /printer:"Brother TD-2350D (203 dpi)" /get_firmwarever  
pause
```

2. Start the **Windows Task Scheduler**.

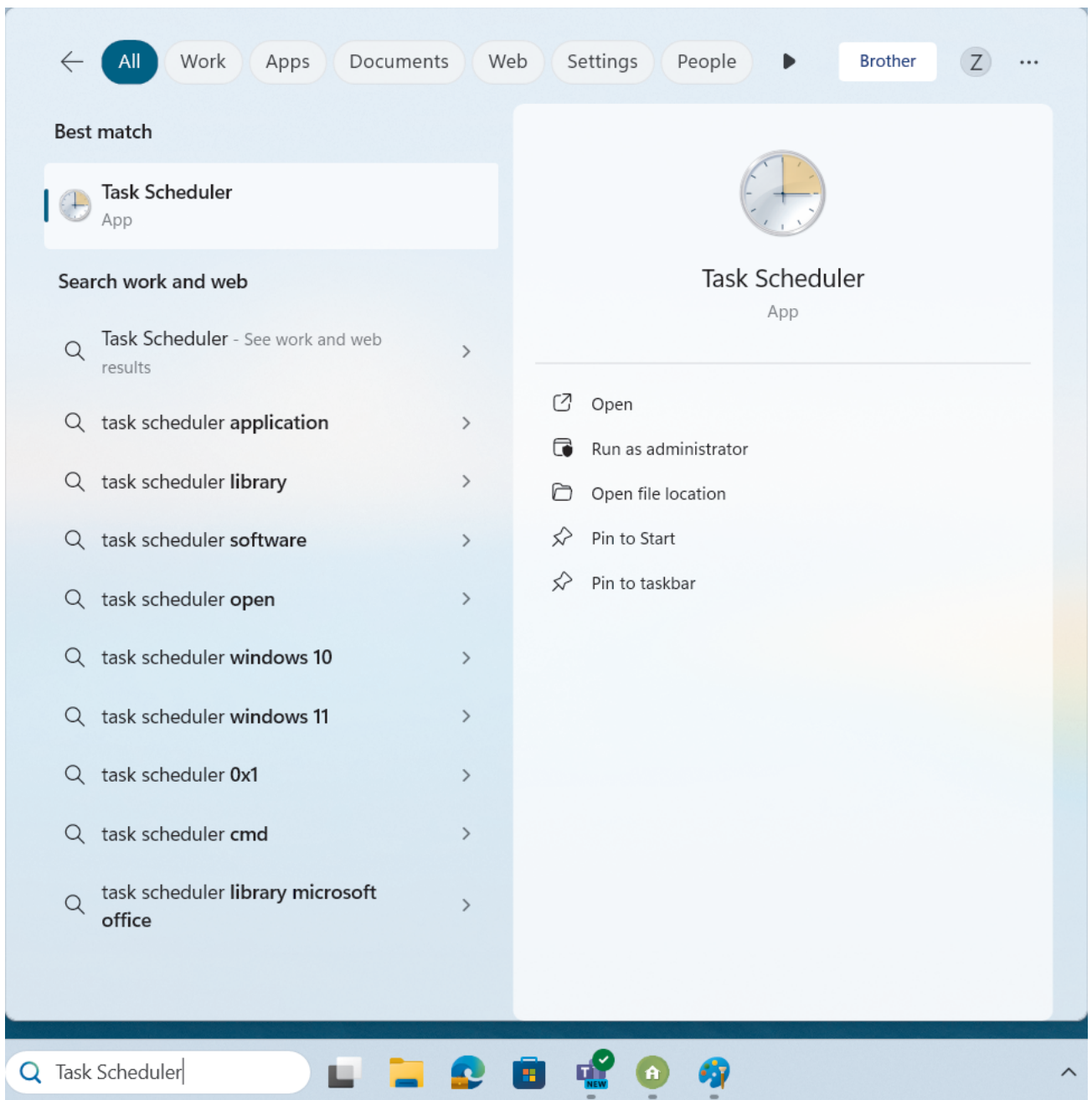

3. Click **Create Basic Task**.

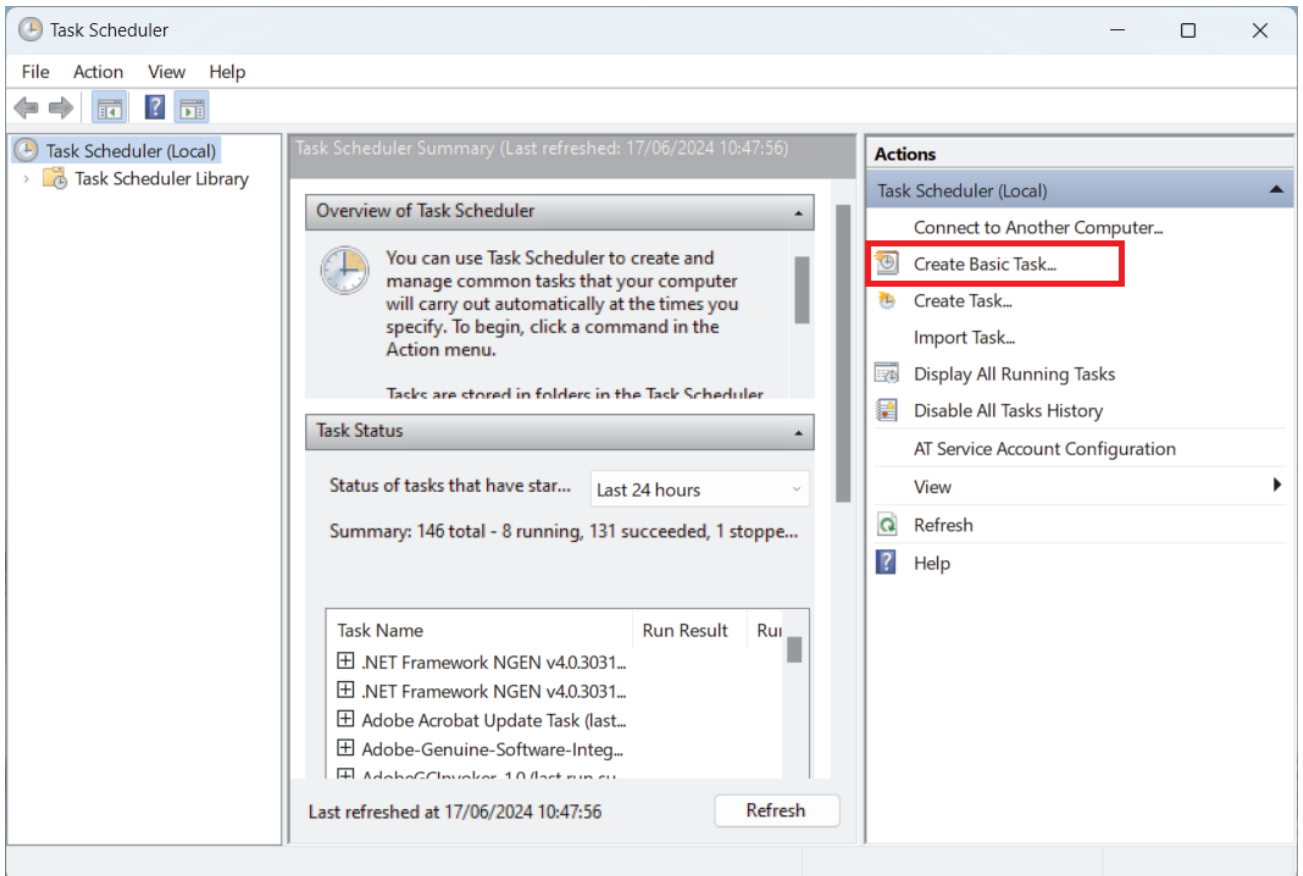

4. Type the task name in the **Name** field, and then click **Next**.

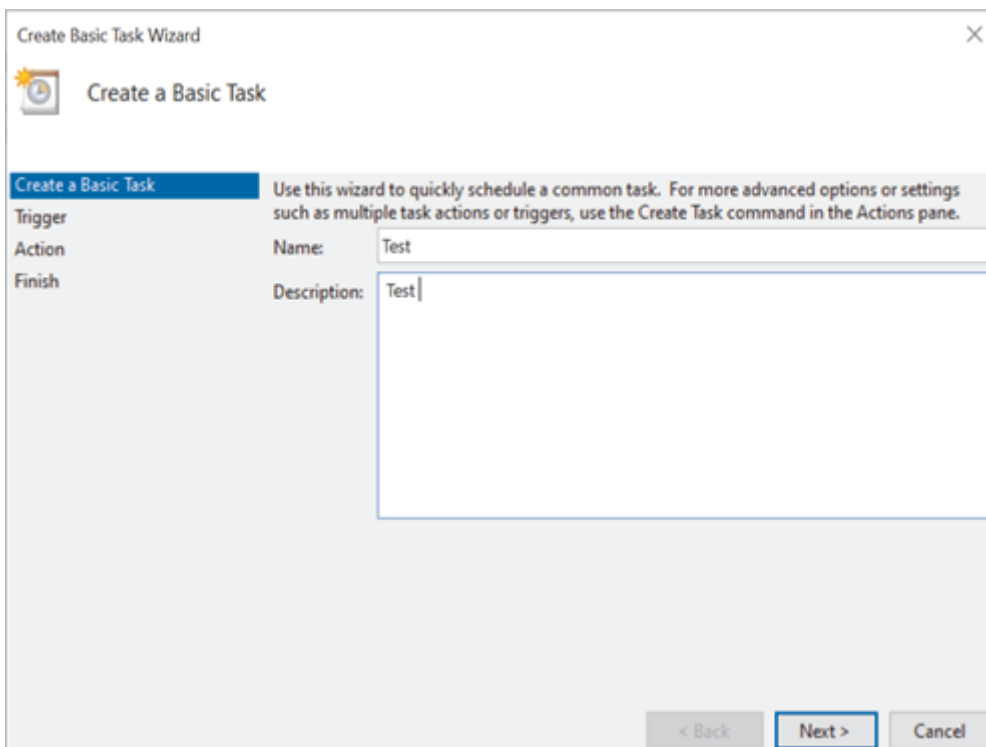

5. Select the trigger for the task.

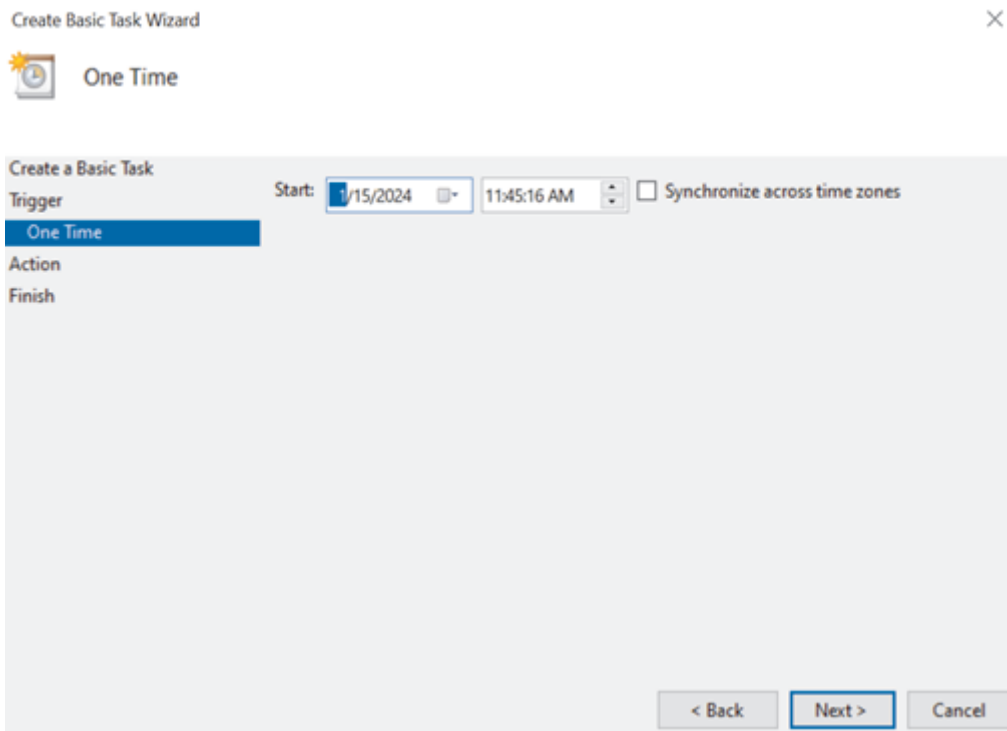
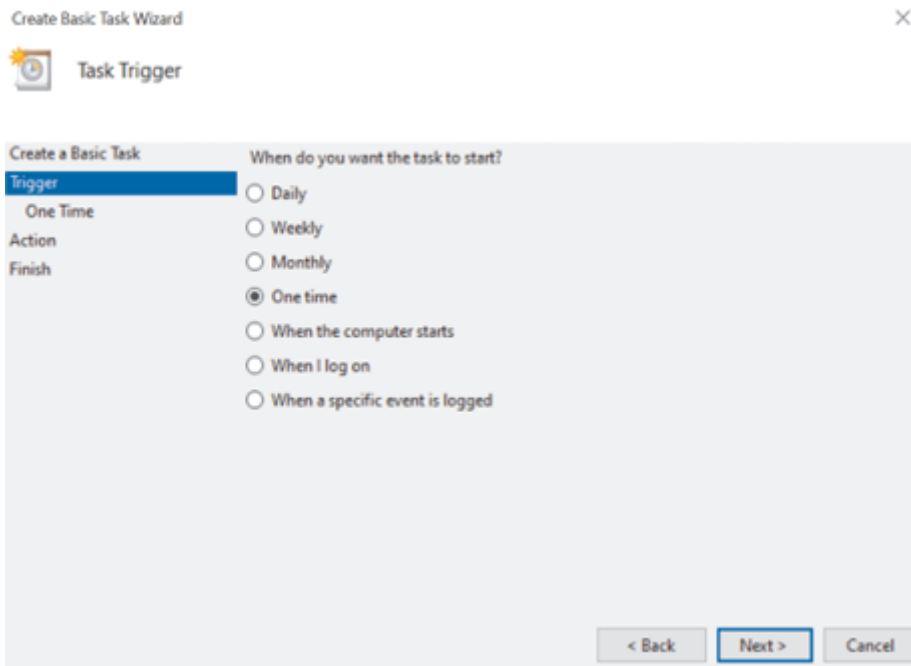

6. Select what you want to perform in the task (in this example, we have selected to **Start a program**), and then click **Next**.

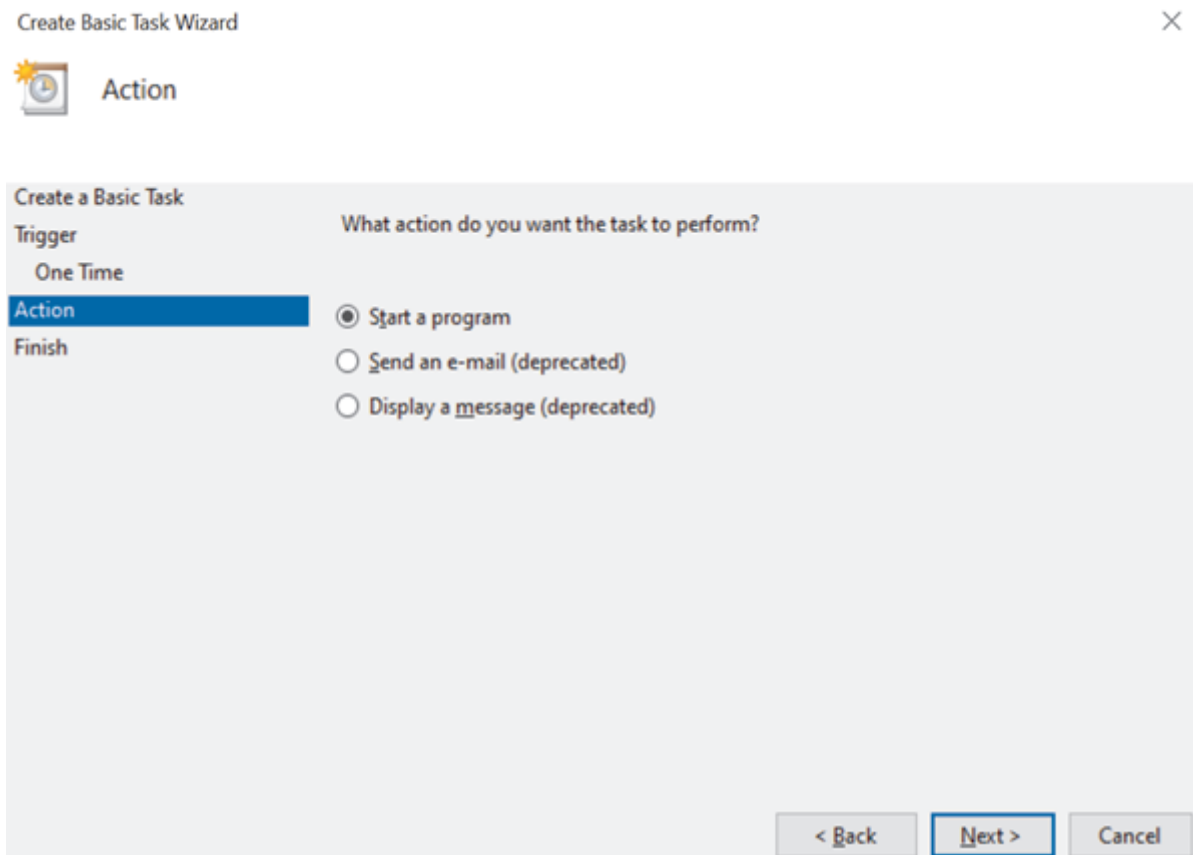

7. Specify the prepared batch file in the **Program/script** field, and then click **Next**.

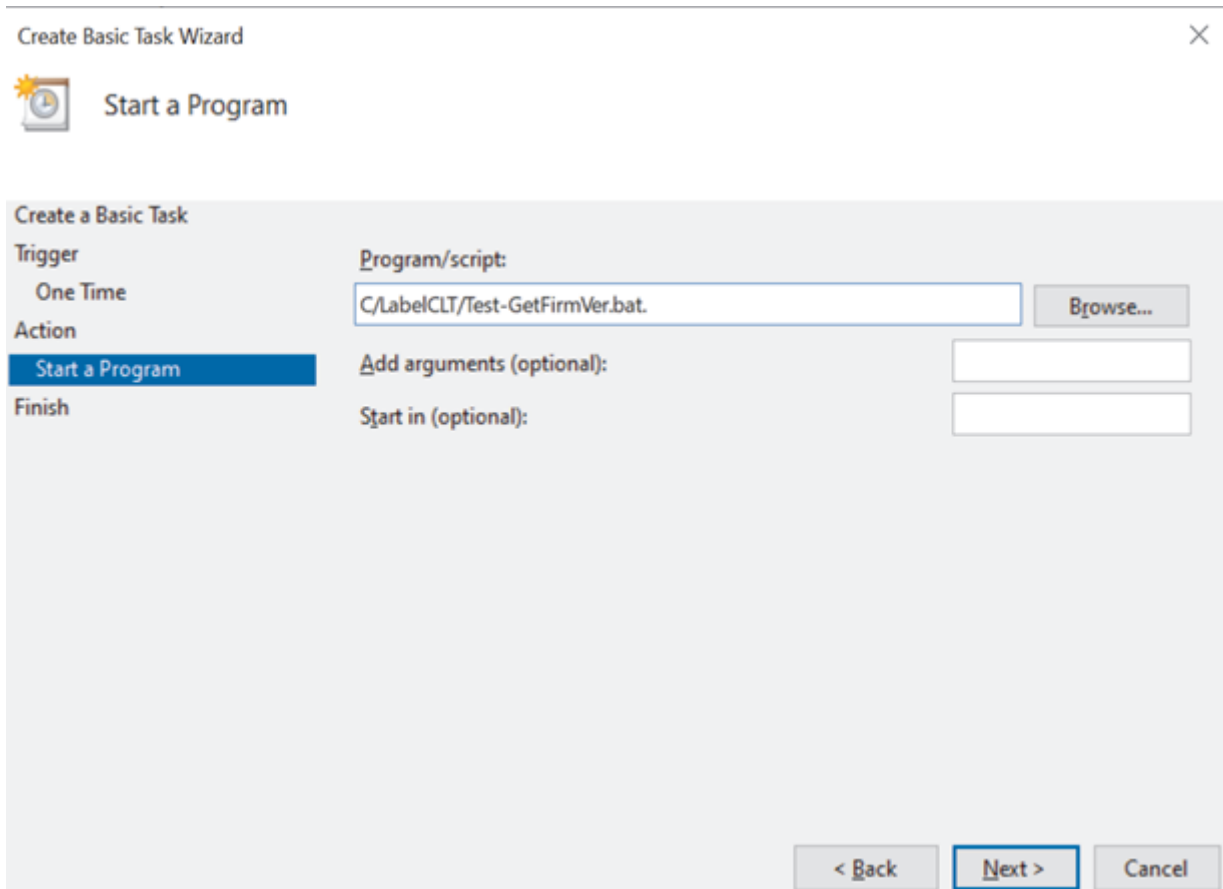

- Click **Finish** to complete creating the task.

The screenshot shows the 'Create Basic Task Wizard' window, specifically the 'Summary' step. The window title is 'Create Basic Task Wizard' with a close button (X) in the top right corner. Below the title bar is a 'Summary' icon and the word 'Summary'. The main area is titled 'Create a Basic Task' and contains a sidebar on the left with the following options: 'Trigger', 'One Time', 'Action', 'Start a Program', and 'Finish'. The 'Finish' option is highlighted in blue. To the right of the sidebar, there are several fields: 'Name:' with the value 'Test', 'Description:' with the value 'Test', 'Trigger:' with the value 'One time; At 11:45 AM on 1/15/2024', and 'Action:' with the value 'Start a program; C:/LabelCLT/Test-GetFirmVer.bat'. Below these fields is a checkbox labeled 'Open the Properties dialog for this task when I click Finish' which is checked. Underneath the checkbox is the text 'When you click Finish, the new task will be created and added to your Windows schedule.' At the bottom right, there are three buttons: '< Back', 'Finish' (highlighted in blue), and 'Cancel'.

- The task of checking the target printer's firmware will be completed at the specified time and using the specified batch file.

✓ Related Information

- [LabelCLT](#)

Product Dimensions



All measured values are in millimeters.

Printer

Front view

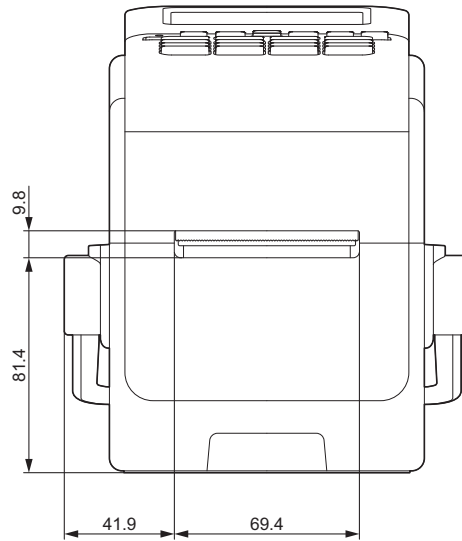
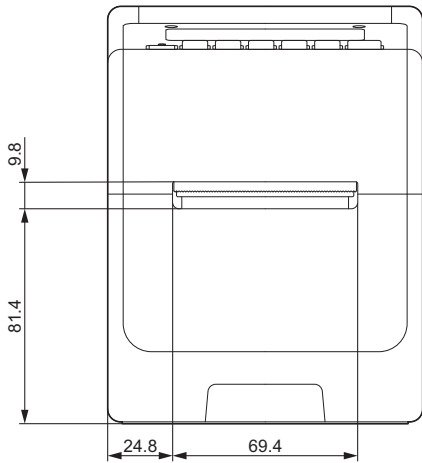

Back view

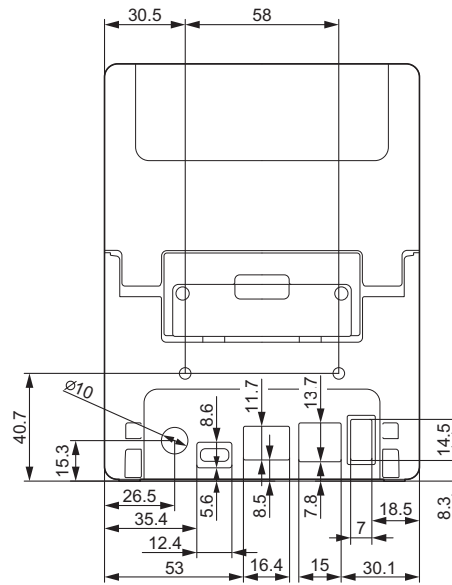
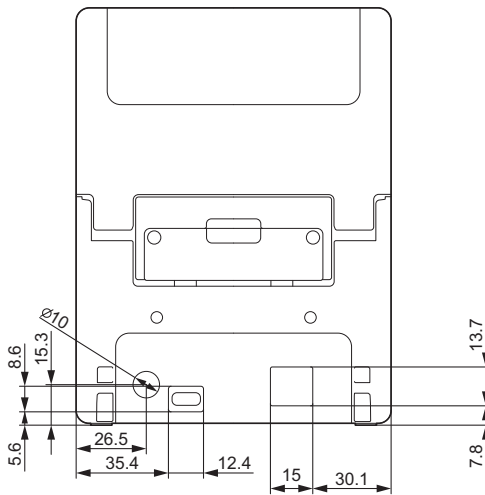

Top view / Bottom view

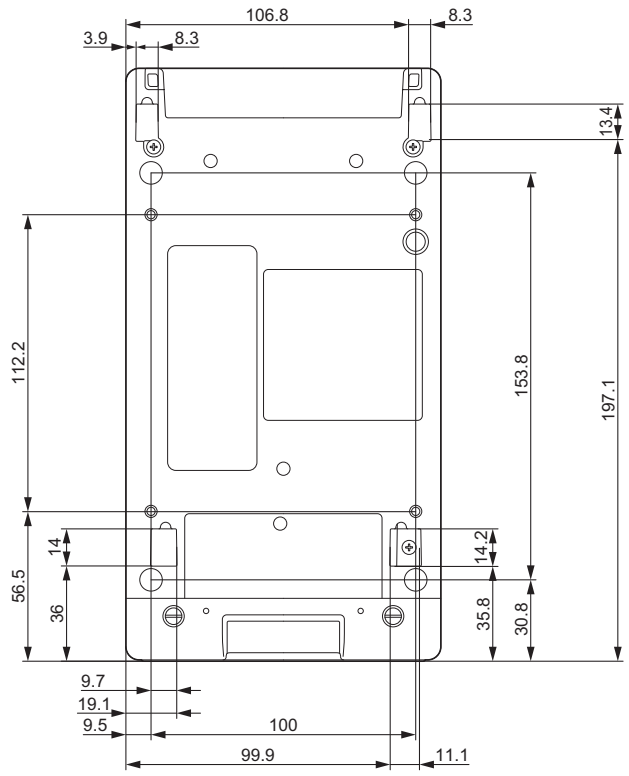
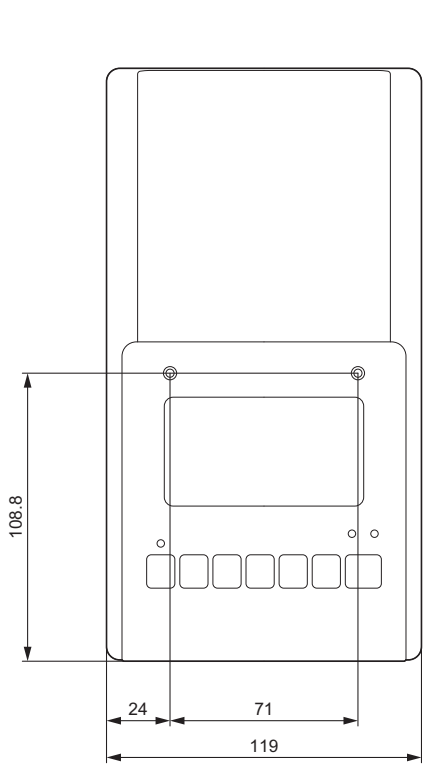

Side view

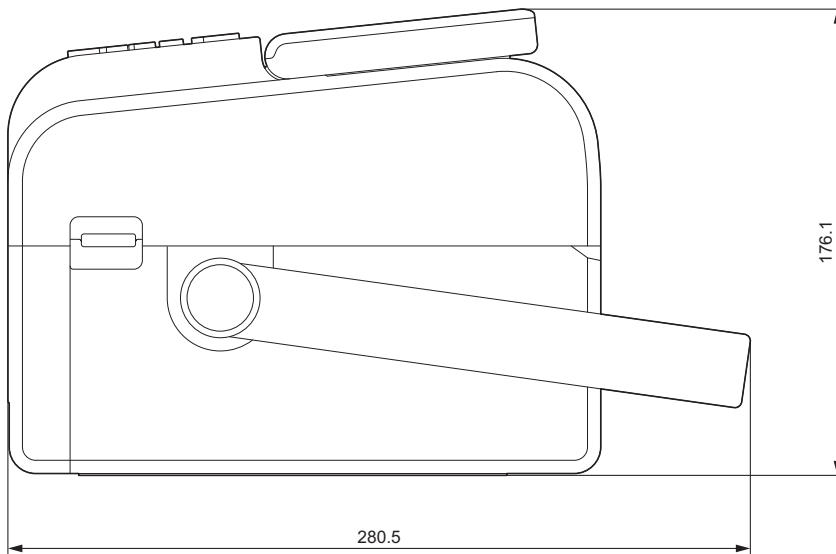
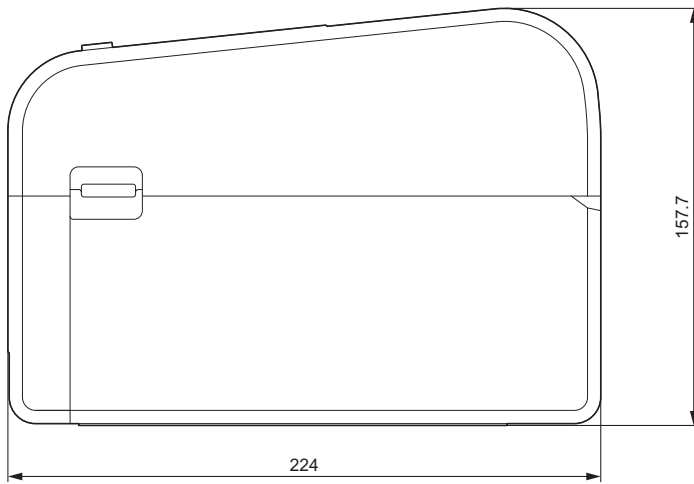

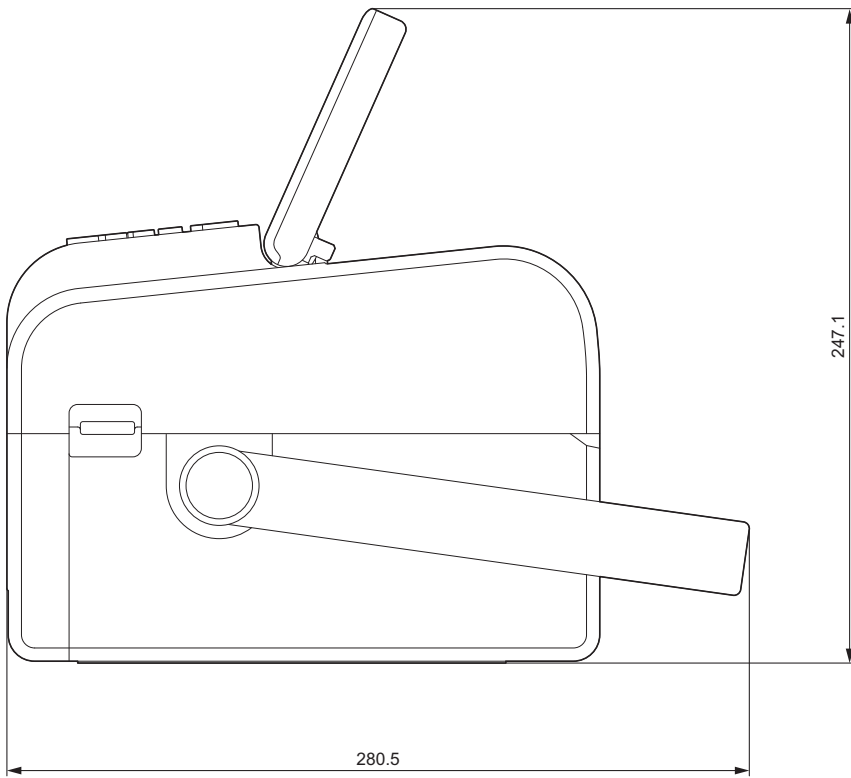
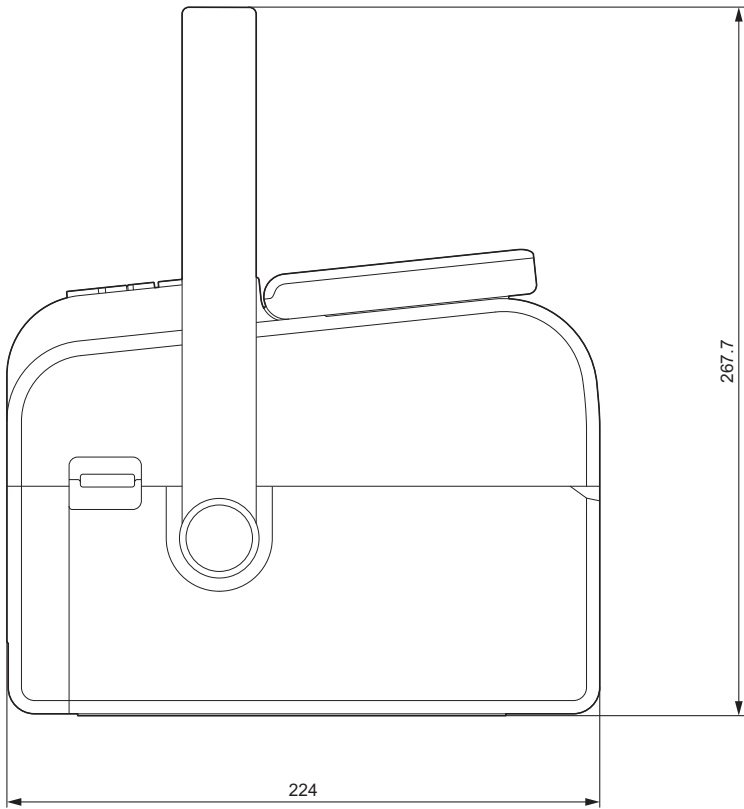

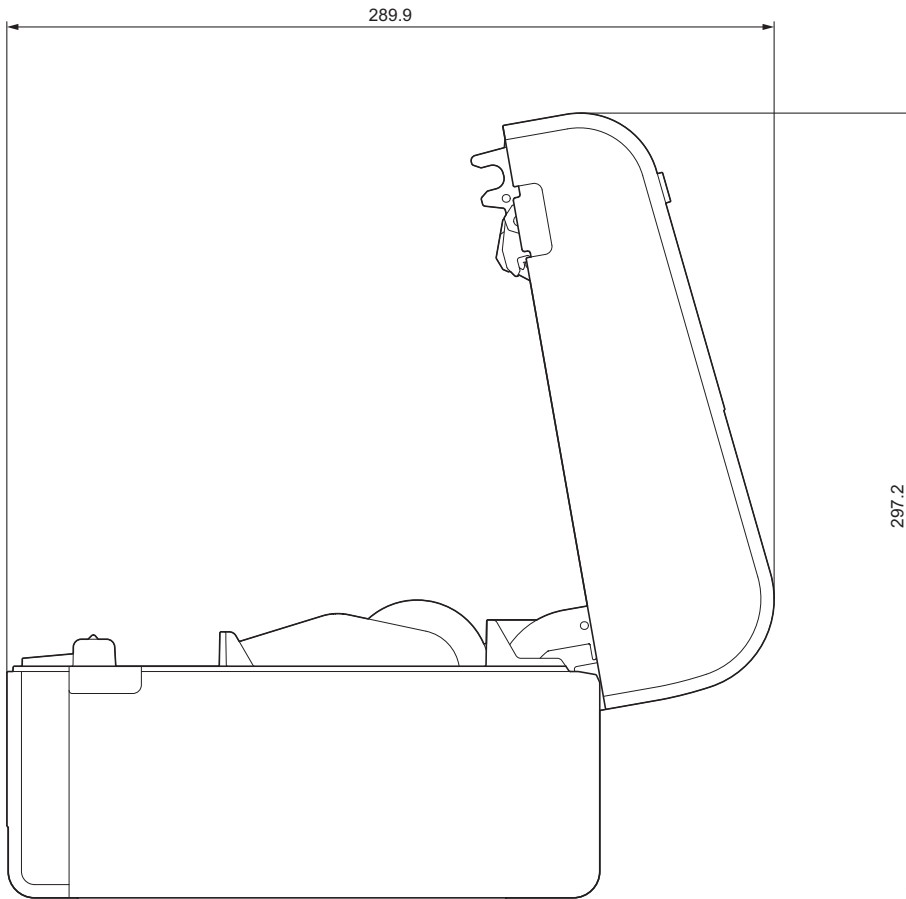

Buttons Arrangement / LCD Arrangement

Button Height

- Power: 0 mm
- Others: 2 mm

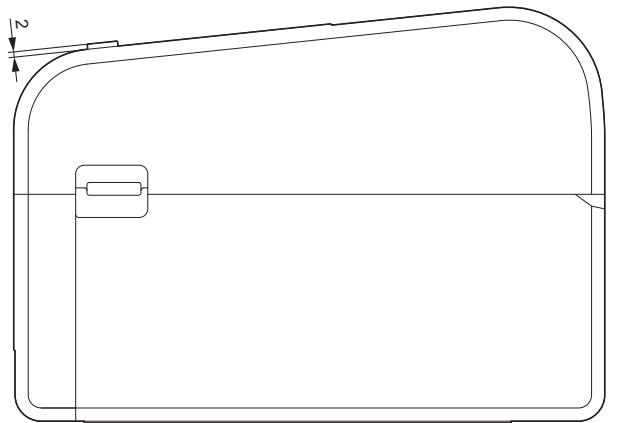
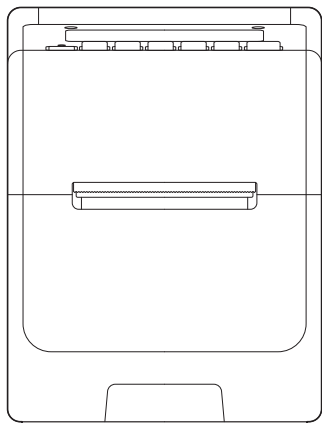
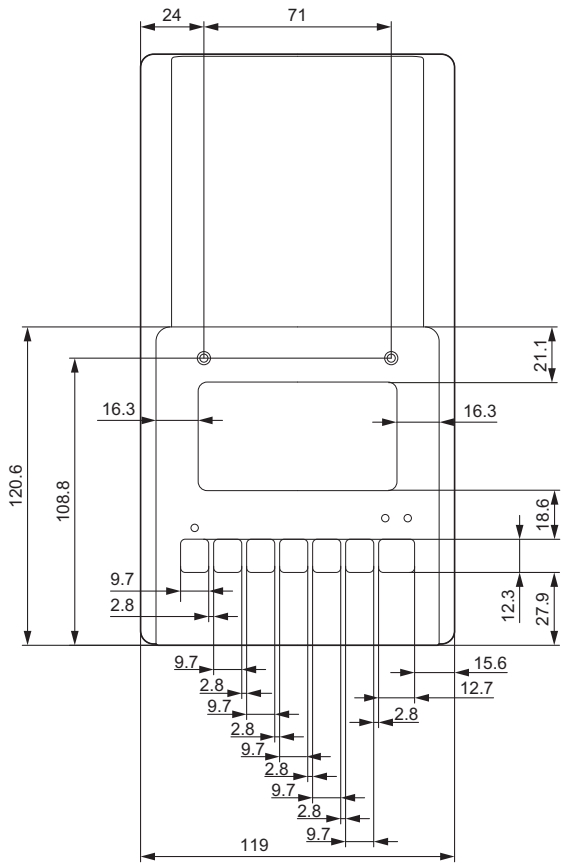

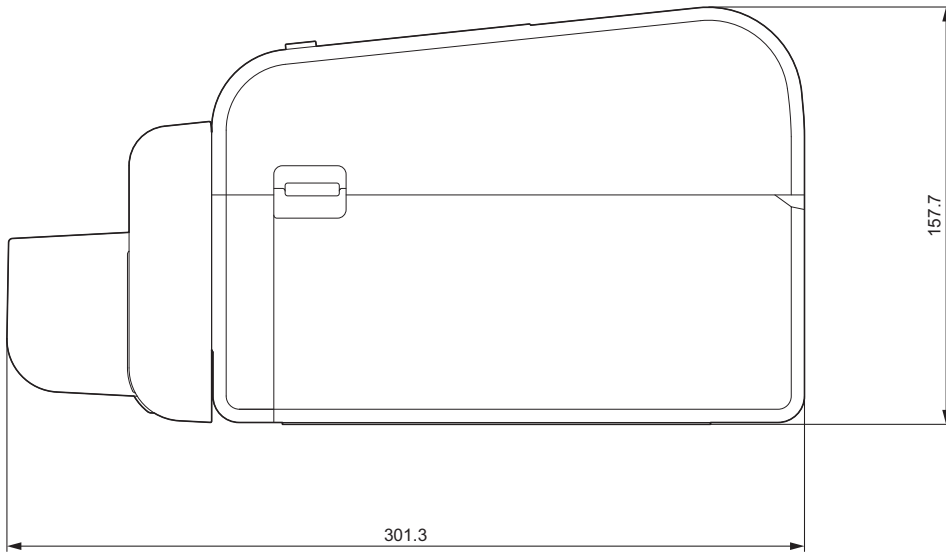

Peeler Unit Installed

Side view

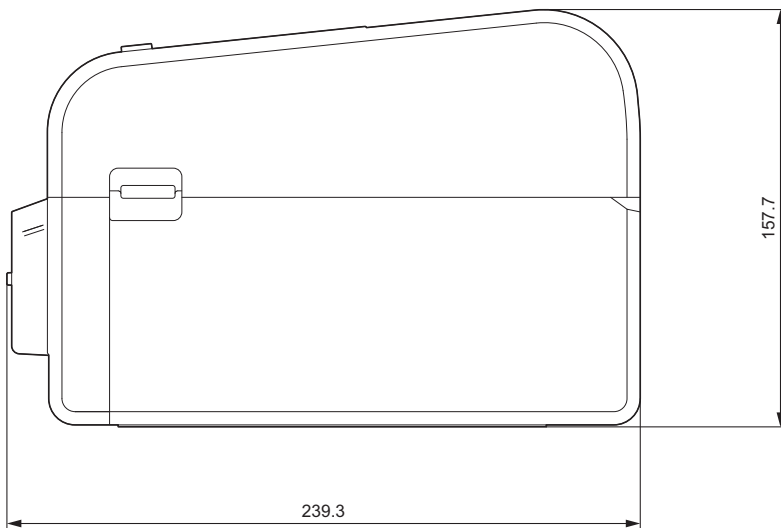

Linerless Cutter Unit Installed

Side view

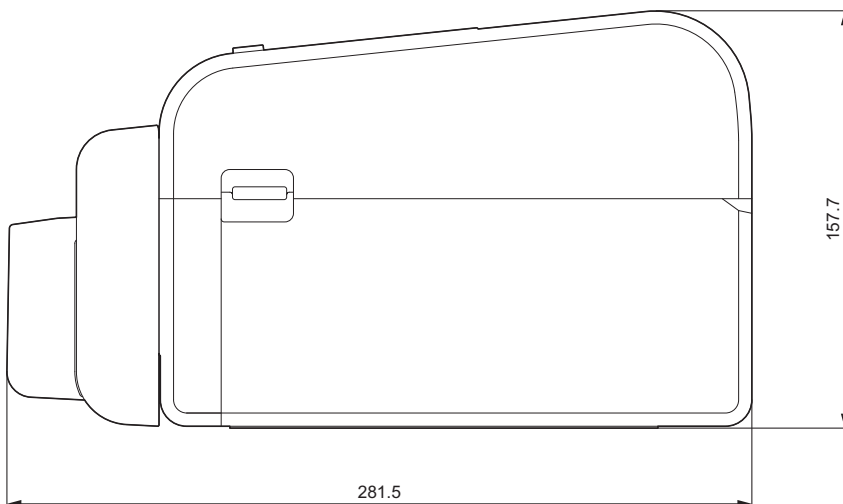

Installation Location

- Place the printer on a flat, stable surface that is well ventilated, and where there is enough room to open Covers and plug in any cords or cables.
- Make sure to leave enough space above, behind, and around the printer, as shown in the illustrations.

NOTE

- Do not place the printer where it is exposed to:
 - direct sunlight
 - high temperature and humidity
 - rapid temperature changes
 - vibrations
 - heavy dust
- Do not place the printer near:
 - equipment that generates magnetic or electromagnetic waves
 - fire or liquids

Doing so may result in fire, electric shock, or injury.

- TD-2350D/TD-2350DF/TD-2350DSA:

Do not place the printer in areas covered by metal (for example, metal shelves and spaces shielded by metal doors) since it can cause loss of radio communication.

Top View

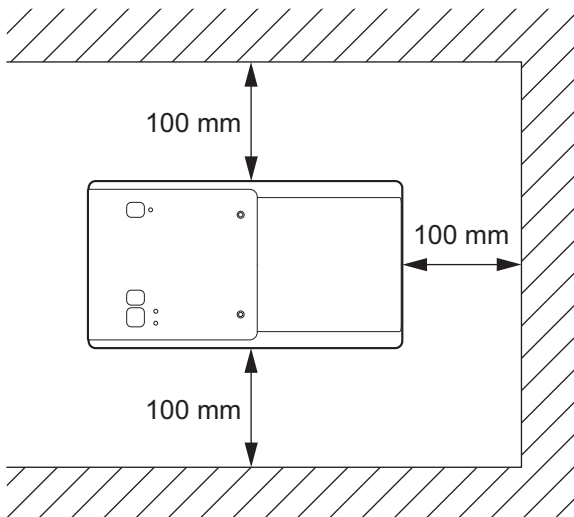

Side View

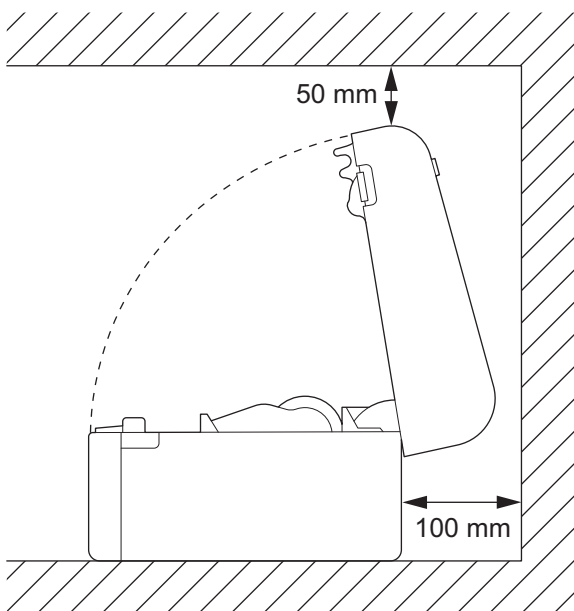



Related Information

- [Appendix](#)
-

Auto Media Configuration

- [Auto Media Configuration Overview](#)
- [Use the Auto Media Configuration Function](#)
- [Adjust the Sensor Position](#)

Auto Media Configuration Overview

Auto Media Configuration allows the printer to automatically detect characteristics of the installed paper, and then select the correct paper size settings.

Model	Automatically Detects:
TD-2310D	Length ¹
TD-2320D/TD-2350D/TD-2320DSA/TD-2350DSA	<ul style="list-style-type: none"> • Paper type • Width • Length • Label spacing • Width of marks • Gap/Black mark detection sensitivity
TD-2320DF/TD-2350DF	<ul style="list-style-type: none"> • Paper type • Width

Auto Media Configuration Workflow

When Auto Media Configuration begins, the printer automatically feeds the media so it can detect its characteristics. By default, the printer uses the continuous feed setting unless:

- The transmissive/gap sensor detects a die-cut label.
- The reflective/black mark sensor detects marked media. ²



- If there is not enough media and it runs out during Auto Media Configuration, the printer will not detect the media type successfully. The LCD will display an error message. Follow the on-screen instructions and try again.
- If the media is not aligned correctly, calibration will not be successful.
- Depending on the media's shape and material, media detection may not be possible.
- TD-2310D:
Width defaults to the width of the last media you used.
- TD-2320D/TD-2350D/TD-2320DF/TD-2350DF/TD-2320DSA/TD-2350DSA:
Width is calculated automatically by subtracting 2.0 mm from the left and right of the detected width.



Related Information

- [Auto Media Configuration](#)

¹ Available when you select the **Paper Size Setup** option on the Printer Setting Tool.

² Depending on the results, you may have to feed the media again.

Use the Auto Media Configuration Function

- >> TD-2320D/TD-2320DF
- >> TD-2350D/TD-2350DF/TD-2320DSA/TD-2350DSA
- >> Calibrate Media Information Using the Printer Setting Tool

TD-2320D/TD-2320DF

Calibrate media information using the printer buttons.

Press and hold  until the Status LED lights up and then goes off.

After calibration is complete, the detected media information is set on the printer.

TD-2350D/TD-2350DF/TD-2320DSA/TD-2350DSA

Calibrate media information using the LCD menu.

1. Press **Menu**.
2. Press **▲** or **▼** to select the following:
 - a. Select [Media]. Press **OK**.
 - b. Select [Calibration]. Press **OK**.

After calibration is complete, the detected media information is set on the printer.

Calibrate Media Information Using the Printer Setting Tool

1. Connect the printer to the computer.
2. Start the Printer Setting Tool.

Click **Start > Brother > Printer Setting Tool**.
3. Click **Paper Size Setup**.
4. Click **Edit** or **New**.
5. TD-2310D: Click **Auto media configuration**.

After calibration is complete, the detected media information is set on the printer.
6. TD-2320D/TD-2350D/TD-2320DF/TD-2350DF/TD-2320DSA/TD-2350DSA: Click the **Auto media configuration**.

A list of detected printers appears.
7. Click **Import** to apply the results to the paper size settings.

Related Information

- [Auto Media Configuration](#)

Print History

Print history can be displayed on your printer ¹ or obtained in the form of a CSV file. Use the Printer Setting Tool to retrieve the CSV file.

The information displayed on the printer and contained in the CSV file is identical:

Column A	Column B	Column C	Column D	Column E	Column F	Column G	Column H	Column I	Column J
Date and Time	Template Name	Database Name	Line number	Number of sheets printed	Key Assign Number	Interface	Error	Print history optional information ²	Object data ³

Column G displays the following:

Code Meaning

Blank	Printed via printer operation
U1	Received via USB function
B	Received via Bluetooth classic equivalent
N	Received via wireless or wired LAN
RS	Received via RS-232C
H	Received via USB host
MS	Received via USB mass storage
LE	Received via Bluetooth Low Energy

Column H displays the following:

Code Meaning

01	Feed error
02	Tape end error
03	Communication command error
05	Cutter error
09	USB host memory full error
0A	Cover open error
0B	BLF file error
0C	JPEG file error
0D	Database search error
0E	No template error
10	Access point search error
11	Access point connection error
14	ESC/P memory full error
15	Data update incomplete error (LAN)
16	Mass storage error
17	USB host overcurrent error

¹ Available on TD-2320DSA/TD-2350DSA

² Outputs text information added to print commands by SDK or other methods. This field is left blank for template printing.

³ Displays the contents of objects with the character "@H@" in the object name.

-
- 18 USB host hub connected error
 - 19 Low battery error
 - 1C USB host non-compatible device connection error
 - 1E High temperature error
 - 1F Battery error
 - 20 Data update incomplete error (USB)
 - 21 Head undetected error
 - 26 Maximum print length exceeded error
 - 27 Time acquisition error
 - 33 Unsupported option error
 - 34 Firmware update incomplete error



Related Information

- [Appendix](#)

Options

- [Recommended Tightening Torque When Installing Optional Parts](#)
- [Change the Label Peeler Options \(Windows\)](#)
- [Change the Cutting Options \(Windows\)](#)

Recommended Tightening Torque When Installing Optional Parts

Applicable screws: Screws for installing the Battery Base, Cutter, Linerless Cutter, and Peeler on the printer.

Recommended tightening torque: 0.35 ± 0.1 N·m



Related Information

- [Options](#)
-

Change the Label Peeler Options (Windows)

After attaching the Label Peeler, set the printer driver peeler option:

1. Select the **Use Peeler Function** checkbox in the printer driver.
2. Click **OK**.



Related Information

- [Options](#)
-



Change the Cutting Options (Windows)

Related Models: TD-2320D/TD-2350D/TD-2320DSA/TD-2350DSA

The cutting options allow you to specify how labels are fed and cut. If you do not use P-touch Editor, you can change the cutting options in the printer driver by following these steps:

1. Click **Printing Preferences** in the printer driver.
2. Select the **Cut Every** checkbox, and then select where to cut when multiple labels are printed.
3. Select the **Cut at End** checkbox.
4. Click **OK**.

Label Cutting Options

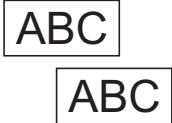
Auto Cut (Cut every one label)	Cut at End	Example
Off	On	
Off	Off	
On	On or Off	



Related Information

- [Options](#)

Brother Help and Customer Support

If you need help with using your Brother product, visit support.brother.com for FAQs and troubleshooting tips. You can also download the latest software, drivers and firmware, to improve the performance of your machine, and user documentation, to learn how to get the most from your Brother product.

Further product and support information is available from your local Brother office website. Visit global.brother/en/gateway to find the contact details for your local Brother office and to register your new product.



Related Information

- [Appendix](#)
-

brother



UK
Version A