



User's Guide

PT-D410

PT-D460BT

Table of Contents

Before You Use Your Label Printer	1
Definitions of Notes	2
General Precautions	3
Trademarks and Licences	4
Important Note	5
Set Up Your Label Printer	6
Parts Description.....	7
LCD Overview	8
Keyboard Overview.....	10
Connect the AC Adapter	14
Install Batteries.....	15
Insert Tape Cassette	16
Turn the Label Printer On/Off.....	17
Set Language.....	18
Set Measurement Units.....	19
Set Auto Power-Off Time	20
Enable or Disable Bluetooth.....	22
Feed Tape	23
Adjust LCD Contrast	24
Turn the Backlight On/Off.....	25
Install Software	26
Install the Printer Driver and Software on a Computer (Windows).....	27
Available Applications.....	28
Connect the Label Printer to a Computer.....	29
Connect the Label Printer to a Computer Using a USB Cable.....	30
Edit a Label	31
Add Text to Your Label	32
Add a New Line of Text to Your Label	33
Add a New Block of Text to Your Label	35
Delete Text	37
Insert a Tab	38
Change the Tab Length	39
Use Text Reminder to Autocomplete Common Words.....	40
Clear Text Reminder Memory	41
Enable or Disable Text Reminder	42
Enter Symbols.....	43
Enter Symbols Using the Symbol Function	44
Set Symbol History	45
Symbol Options	46
Enter Accented Characters	50
Accented Character Options	51
Set Character Attributes.....	53
Apply Character Attributes to a Character.....	54
Apply Character Attributes to a Line of Text.....	55
Attribute Setting Options	57





Set Auto Fit Style.....	59
Set Label Length.....	60
Set Frames.....	61
Use Auto Format Layouts.....	64
Use Templates.....	65
Template Options.....	68
Template Options.....	69
Use Block Layouts.....	71
Block Layout Options.....	73
Block Layout Options.....	75
Create a Barcode Label.....	77
Create and Print Barcodes.....	78
Edit or Delete a Barcode and Barcode Data.....	81
Print Labels.....	82
Preview Labels.....	83
Print Labels.....	84
Sequential Printing.....	85
Mirror Printing.....	86
Select a Cut Option.....	87
Tape Cutting Options.....	88
Adjust the Label Length.....	90
Use the File Memory.....	91
Save Label Files.....	92
Print, Open, and Delete a Saved Label.....	93
Create and Print Labels Using Your Computer.....	94
Create Labels Using P-touch Editor (Windows).....	95
Create Labels and Print Using P-touch Editor (Mac).....	96
Main Window of P-touch Editor (Mac).....	97
Print Labels Using the Printer Driver (Windows).....	98
Print Labels Using Mobile Devices.....	99
Install the Brother iPrint&Label App.....	100
Create Labels and Print Using Mobile Devices.....	101
Routine Maintenance.....	102
Maintenance.....	103
Troubleshooting.....	105
If You Are Having Difficulty with Your Label Printer.....	106
Error and Maintenance Messages.....	108
Check the Version Information.....	109
Reset the Label Printer.....	110
Reset the Printer to the Factory Settings.....	111
Reset Using the LCD.....	112
Appendix.....	113
Specifications.....	114
Brother Help and Customer Support.....	116

Before You Use Your Label Printer

- [Definitions of Notes](#)
- [General Precautions](#)
- [Trademarks and Licences](#)
- [Important Note](#)

Definitions of Notes

We use the following symbols and conventions throughout this User's Guide:

 DANGER	DANGER indicates an imminently hazardous situation which, if not avoided, will result in death or serious injuries.
 WARNING	WARNING indicates a potentially hazardous situation which, if not avoided, could result in death or serious injuries.
 CAUTION	CAUTION indicates a potentially hazardous situation which, if not avoided, may result in minor or moderate injuries.
IMPORTANT	IMPORTANT indicates a potentially hazardous situation which, if not avoided, may result in damage to property or loss of product functionality.
NOTE	NOTE specifies the operating environment, conditions for installation, or special conditions of use.
	The tips icon indicates helpful hints and supplementary information.
Bold	Bold style identifies buttons on the machine's control panel or computer screen.
<i>Italics</i>	Italicised style emphasises an important point or refers you to a related topic.
Courier New	Courier New font identifies messages shown on the machine's LCD.



Related Information

- [Before You Use Your Label Printer](#)

General Precautions

- Depending on the area, material, and environmental conditions, the label may unpeel or become permanently affixed, and the colour of the label may change or be transferred to other objects. Before affixing the label, check the environmental conditions and the material. Test the label by affixing a small piece of it to an inconspicuous area of the intended surface.
- DO NOT use the machine, components, or supplies in any way or for any purpose not described in this guide. Doing so may result in accidents or damage.
- Use only Brother TZe tapes with the Label Printer. DO NOT use tapes that do not have the  mark.
- Use a soft wipe to clean the Print Head; never touch the Print Head.
- DO NOT apply excessive pressure to the Tape Cutter Lever.
- DO NOT try to print if the cassette is empty; it will damage the Print Head.
- DO NOT pull the tape while printing or feeding; it will damage the tape and the Label Printer.
- Any data stored in memory will be lost due to failure, or repair of the printer, or if the batteries discharge completely.
- Printed characters may look different from those displayed in the print preview, as your device's or computer's screen may have a higher resolution than the Label Printer.
- The displayed label length may differ from the actual length of the printed label.
- When power is disconnected for two minutes, all text, format settings, and any text files stored in the memory will be cleared.
- Be sure to read the instructions provided with Fabric Iron-On Tapes, Extra Strength Adhesive Tapes, or other special tapes and observe all precautions noted in the instructions.
- A protective clear plastic film is placed on the LCD during manufacturing and shipping. Remove this film prior to use.



Related Information

- [Before You Use Your Label Printer](#)

Trademarks and Licences

- Android is a trademark of Google LLC.
- Google Play and the Google Play logo are trademarks of Google LLC.
- The Bluetooth® word mark and logos are registered trademark owned by Bluetooth SIG, Inc. and any use of such marks by Brother Industries, Ltd. is under license. Other trademarks and trade names are those of their respective owners.
- QR Code is a registered trademark of DENSO WAVE INCORPORATED.
- Mac, iPad, iPhone, and iPod touch are trademarks of Apple Inc.
- QR Code Generating Program Copyright © 2008 DENSO WAVE INCORPORATED.
- Portions of this software are copyright © 2014 The FreeType Project (www.freetype.org). All rights reserved.

Any trade names and product names of companies appearing on Brother products, related documents and any other materials are all trademarks or registered trademarks of those respective companies.



Related Information

- [Before You Use Your Label Printer](#)
-

Important Note

- The contents of this document and the specifications of this Label Printer are subject to change without notice.
- Brother reserves the right to make changes without notice in the specifications and materials contained herein and shall not be responsible for any damages (including consequential) caused by the reliance on the materials presented, including, but not limited to, typographical and other errors relating to the publications.
- This Label Printer does not support wireless connection.
- Screen images in this document may differ depending on your computer's operating system, your product model, and software version.
- Before using the Label Printer, make sure you read all the documents included with the Label Printer for information about safety and operation.
- The Label Printer shown in the illustrations may be different from your Label Printer.
- The available supplies may vary depending on your country or region.
- We recommend using the latest version of P-touch Editor.
- To keep your Label Printer's performance up to date, visit support.brother.com to check for the latest firmware updates. Otherwise, some of your Label Printer's functions may not be available.
- When replacing or disposing of your Label Printer, Brother strongly recommends resetting it to its factory settings to remove all personal information.



Related Information

- [Before You Use Your Label Printer](#)
-

Set Up Your Label Printer

- [Parts Description](#)
- [LCD Overview](#)
- [Keyboard Overview](#)
- [Connect the AC Adapter](#)
- [Install Batteries](#)
- [Insert Tape Cassette](#)
- [Turn the Label Printer On/Off](#)
- [Set Language](#)
- [Set Measurement Units](#)
- [Set Auto Power-Off Time](#)
- [Enable or Disable Bluetooth](#)
- [Feed Tape](#)
- [Adjust LCD Contrast](#)
- [Turn the Backlight On/Off](#)

Parts Description

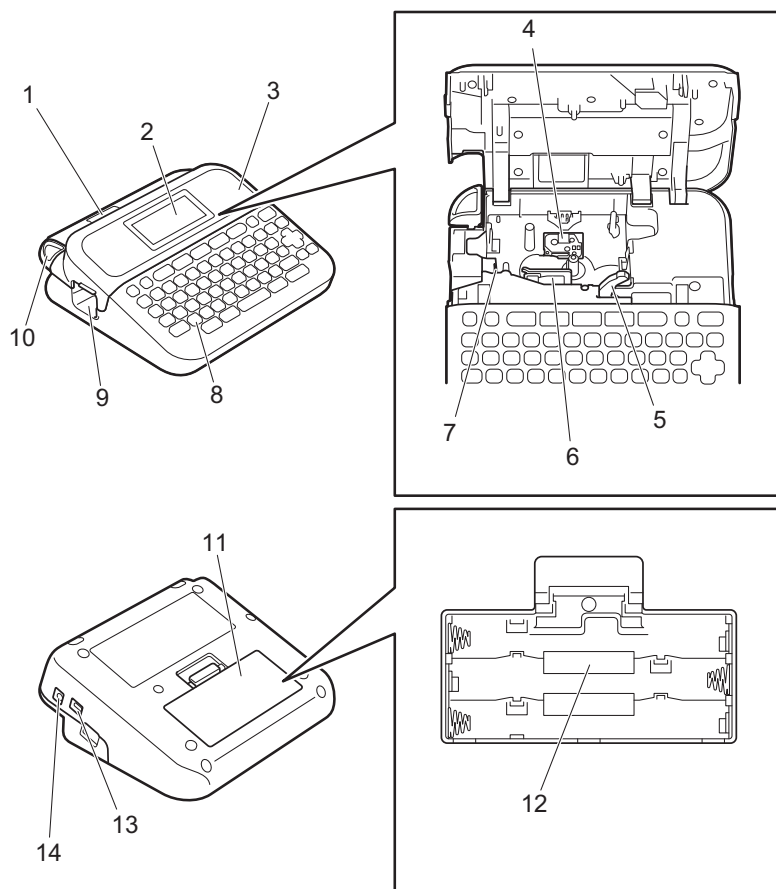

1. Tape Viewer
2. Liquid Crystal Display (LCD)
3. Tape Cassette Compartment Cover
4. Tape Cassette Compartment
5. Release Lever
6. Print Head
7. Tape Cutter
8. Keyboard
9. Tape Exit Slot
10. Tape Cutter Lever
11. Battery Compartment Cover
12. Battery Compartment
13. USB Port
14. AC Adapter Socket



Related Information

- [Set Up Your Label Printer](#)

LCD Overview

>> [PT-D410](#)

>> [PT-D460BT](#)

PT-D410



- 1. Caps mode**
Indicates if the caps lock mode is enabled.
- 2. Current font**
Indicates the current font.
- 3. Character size**
Indicates the current character size.
- 4. Character style**
Indicates the current character style.
- 5. Frame**
Indicates if a frame is set.
- 6. Tape length**
Indicates the tape length for the text entered.
- 7. Block number**
Indicates the block number.
- 8. Line number**
Indicates line numbers within the label layout.
- 9. Start Line**
Indicates the start line.
- 10. Return mark**
Indicates the end of a line of text.
- 11. Cursor**
Indicates the current data entry position.
New characters appear to the left of the cursor.
- 12. End Line**
Indicates the end line.

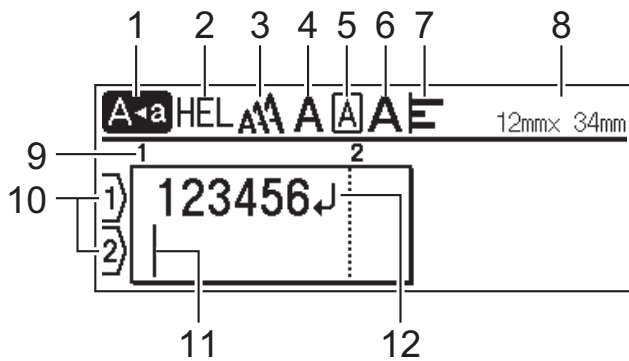

- 1. Caps mode**
Indicates if the caps lock mode is enabled.
- 2. Current font**
Indicates the current font.
- 3. Character size**
Indicates the current character size.
- 4. Character style**
Indicates the current character style.
- 5. Frame**
Indicates if a frame is set.
- 6. Width**
Indicates the character width.
- 7. Align**
Indicates the text alignment.
- 8. Tape width x Label length**
Indicates the tape width and label length.
The label length displayed on the LCD may slightly differ from the actual label length when printed.
- 9. Block number**
Indicates the block number.
- 10. Line number**
Indicates line numbers within the label layout.
- 11. Cursor**
Indicates the current data entry position.
New characters appear to the left of the cursor.
- 12. Return mark**
Indicates the end of a line of text.

✓ Related Information

- [Set Up Your Label Printer](#)

Keyboard Overview

>> PT-D410

>> PT-D460BT

PT-D410

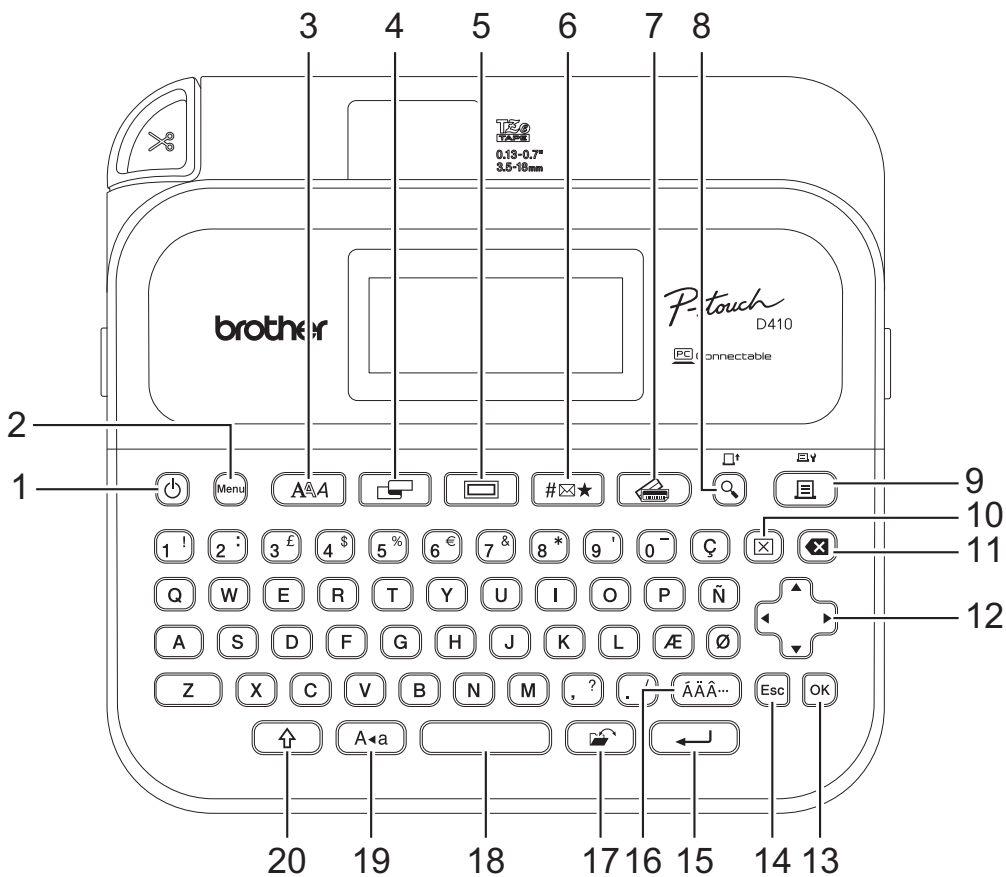

1. Power

Press to turn the Label Printer on or off.

2. Menu

Press to access the main menu.

3. Font

Press to select a font.

4. Label

Press to access label attributes.

5. Frame

Press to select a frame.

6. Symbol

Press to select and insert a symbol from the symbols menus.

7. Auto Format

Press to select a label format from preset templates or layouts.

8. Preview/Feed

Press to view an image of the label before printing.

To feed the Tape, press **Preview/Feed** and the **Shift** key simultaneously.

9. Print/Print Options

Press to print.

To set Print Options, press **Print/Print Options** and the **Shift** key simultaneously.

10. Clear

Press to clear all text and print settings.

11. Backspace

Press to delete any character to the left of the cursor.

12. Cursor

Press to move the cursor in the direction of the arrow.

13. OK

Press to select the displayed option.

14. Escape

Press to cancel the current operation.

15. Enter

Press to confirm your selection.

16. Accent

Press to select and insert an accented character.

17. File

Press to retrieve data saved in the file memory.

18. Space

Press to insert a blank space.

Press to return to the default value.

19. Caps

Press to use upper-case letters only.

20. Shift

Press and hold when pressing a letter or number key to type an upper-case letter or the symbol marked on the number key.

To move the cursor to the beginning of your text, press **Shift** and the ◀ key simultaneously.

To move the cursor to the end of your text, press **Shift** and the ▶ key simultaneously.

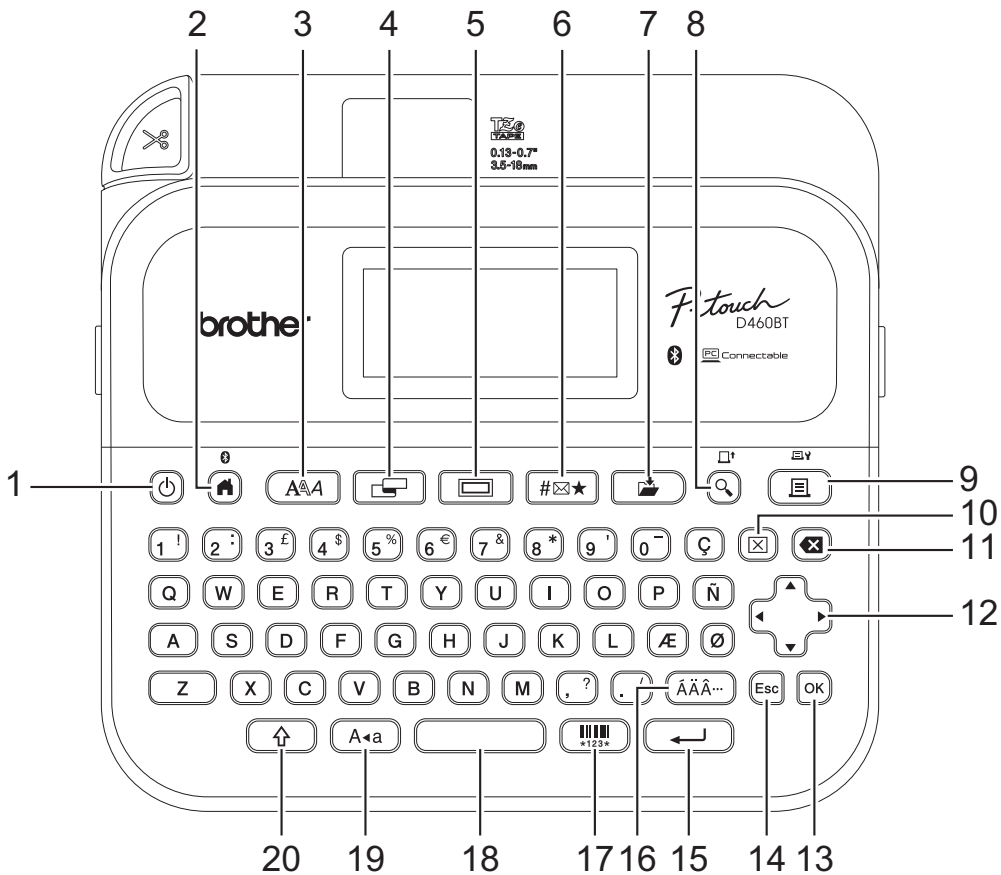

1. Power

Press to turn the Label Printer on or off.

2. Home/Bluetooth

Press to return to the Home Screen. To turn Bluetooth on or off, press **Home/Bluetooth** and the **Shift** key simultaneously.

3. Font

Press to select a font.

4. Label

Press to access label attributes.

5. Frame

Press to select a frame.

6. Symbol

Press to select and insert a symbol from the symbols menus.

7. Save

Press to save the created data in the file memory.

8. Preview/Feed

Press to view an image of the label before printing.

To feed the Tape, press **Preview/Feed** and the **Shift** key simultaneously.

9. Print/Print Options

Press to print.

To set Print Options, press **Print/Print Options** and the **Shift** key simultaneously.

10. Clear

Press to clear all text and print settings.

11. Backspace

Press to delete any character to the left of the cursor.

12. Cursor

Press to move the cursor in the direction of the arrow.

13. OK

Press to select the displayed option.

14. Escape

Press to cancel the current operation.

15. Enter

Press to confirm your selection.

16. Accent

Press to select and insert an accented character.

17. Barcode

Press to create a barcode label.

18. Space

Press to insert a blank space.

Press to return to the default value.

19. Caps

Press to use upper-case letters only.

20. Shift

Press and hold when pressing a letter or number key to type an upper-case letter or the symbol marked on the number key.

To move the cursor to the beginning of the previous or next block, press **Shift** and the ▲ or ▼ key simultaneously.

To move the cursor to the beginning or end of the current line, press **Shift** and the ◀ or ▶ key simultaneously.



Related Information

- [Set Up Your Label Printer](#)
-

Connect the AC Adapter

If connecting a power adapter, use only the AC Adapter, part number AD-E001A, specifically designed for this Label Printer.

1. Insert the AC Adapter cord into the AC Adapter Socket on the side of the Label Printer.
2. Insert the plug into the nearest standard electrical socket.

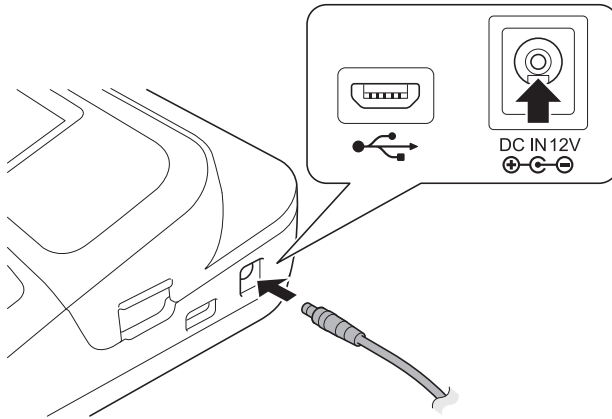

✓ Related Information

- [Set Up Your Label Printer](#)

Install Batteries

To ensure memory backup, we recommend using six new AA alkaline batteries (LR6) along with the AC Adapter.

NOTE

- To safeguard and back up the Label Printer's memory, when the AC Adapter is unplugged, we recommend having AA alkaline batteries installed in the Label Printer.
- When power is disconnected for more than two minutes, all text and format settings will be cleared. Any text files saved in the memory will also be cleared.
- Remove the batteries if you do not intend to use the Label Printer for an extended period of time.
- Dispose of the batteries at an appropriate collection point, not in the general waste stream. In addition, be sure to observe all applicable federal, state, and local regulations.
- When storing or discarding the batteries, wrap them (for example, with cellophane tape, as illustrated), to prevent them from short-circuiting.

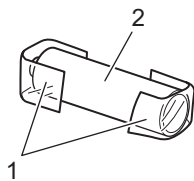

1. Cellophane tape
2. Alkaline battery

1. Open the Battery Compartment Cover.

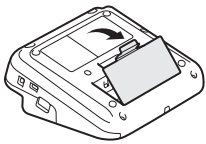

2. Install six new AA alkaline batteries (LR6).
Make sure they are installed in the correct direction.

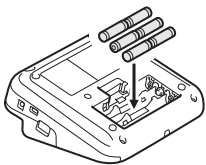

3. Close the Battery Compartment Cover.

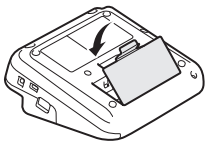

To remove the batteries, reverse the installation procedure.

✓ Related Information

- [Set Up Your Label Printer](#)

Insert Tape Cassette

1. Open the Tape Cassette Compartment Cover.

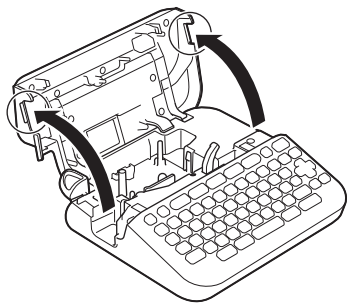

2. Insert the Tape Cassette as illustrated.

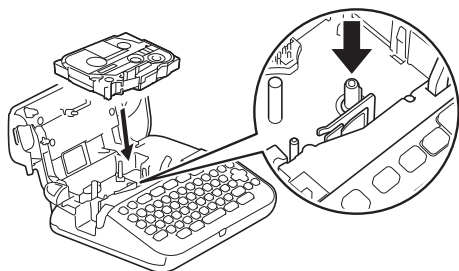

NOTE

When inserting the Tape Cassette, make sure the tape does not catch on the Print Head.

3. Close the Tape Cassette Compartment Cover.





If you cannot close the Tape Cassette Compartment Cover, make sure the Release Lever is in the 'up' position. If not, lift the Release Lever, and then close the cover.



Related Information

- [Set Up Your Label Printer](#)

Turn the Label Printer On/Off

1. To turn the Label Printer on, press .
2. To turn the Label Printer off, press and hold .

To save power and turn the Label Printer off automatically after a specific amount of time, use the Auto Power-Off function.



Related Information

- [Set Up Your Label Printer](#)

Related Topics:

- [Set Auto Power-Off Time](#)
 - [Specifications](#)
-

Set Language

When you turn the Label Printer on for the first time, the language selection screen appears. Select the language using ◀ or ▶, and then press **OK**.

>> [PT-D410](#)

>> [PT-D460BT](#)

PT-D410

1. Press .
2. Press ▲ or ▼ to display [Language], and then press **OK**.
3. Press ▲ or ▼ to select your language, and then press **OK**.

PT-D460BT

1. Press .
2. Press ◀ or ▶ to display [Settings], and then press **OK**.
3. Press ▲ or ▼ to display [Language], and then press **OK**.
4. Press ▲ or ▼ to select your language, and then press **OK**.

✓ Related Information

- [Set Up Your Label Printer](#)

Set Measurement Units

>> [PT-D410](#)

>> [PT-D460BT](#)

PT-D410

1. Press .
2. Press **▲** or **▼** to display [Unit], and then press **OK**.
3. Press **▲** or **▼** to display [inch] or [mm], and then press **OK**.

PT-D460BT

1. Press .
2. Press **◀** or **▶** to display [Settings], and then press **OK**.
3. Press **▲** or **▼** to display [Unit], and then press **OK**.
4. Press **▲** or **▼** to display [inch] or [mm], and then press **OK**.



Related Information

- [Set Up Your Label Printer](#)

Set Auto Power-Off Time

Your Label Printer has a power saving function that automatically turns the printer off if no key is pressed within a certain time, under certain operating conditions. Regardless of whether you use the AC Adapter or the batteries, you can change the automatic powering-off time.

>> [PT-D410](#)

>> [PT-D460BT](#)

PT-D410

1. Press .
2. Press **▲** or **▼** to display [Auto Power Off], and then press **OK**.
3. Press **▲**, **▼**, **◀** or **▶** to select following options:

Option	Description
AC Adapter	Off
	1hr.
	2hr.
	4hr.
	8hr.
Battery	5min.
	10min.
	30min.

4. Press **OK**.

PT-D460BT

1. Press .
2. Press **◀** or **▶** to display [Settings], and then press **OK**.
3. Press **▲** or **▼** to display [Auto Power Off], and then press **OK**.
4. Press **▲** or **▼** to display [AC Adapter] or [Battery], and then press **OK**.
5. Press **▲** or **▼** to select one of the following options:

Option	Description
AC Adapter	Off
	1hr.
	2hr.
	4hr.
	8hr.
Battery	5min.
	10min.
	30min.

6. Press **OK**.



Related Information

- [Set Up Your Label Printer](#)
-



Enable or Disable Bluetooth

Related Models: PT-D460BT

1. Press .
2. Press ◀ or ▶ to display [Settings], and then press **OK**.
3. Press ◀ or ▶ to display [Bluetooth], and then press **OK**.
4. Press ▲ or ▼ to display [Bluetooth (On/Off)], and then press **OK**.
5. Press ▲ or ▼ to select [On] or [Off], and then press **OK**.

When you select [On], the Bluetooth icon appears on the LCD.





- You can also enable or disable Bluetooth by pressing  and  simultaneously when the Home Screen is displayed.
- Set the Automatic Reconnection mode for Bluetooth to On or Off when you connect the Label Printer to your mobile device.



Related Information

- [Set Up Your Label Printer](#)

Feed Tape

To feed the tape, press  and .



Related Information

- [Set Up Your Label Printer](#)

Adjust LCD Contrast

The LCD Contrast default setting is [0].

>> [PT-D410](#)

>> [PT-D460BT](#)

PT-D410

1. Press .
2. Press ▲ or ▼ to display [Adjustment], and then press **OK**.
3. Press ▲ or ▼ to display [LCD Contrast].
4. Press ◀ or ▶ to select your preference, [-2 - +2], and then press **OK**.

PT-D460BT

1. Press .
2. Press ◀ or ▶ to display [Settings], and then press **OK**.
3. Press ▲ or ▼ to display [Adjustment], and then press **OK**.
4. Press ▲ or ▼ to display [LCD Contrast], and then press **OK**.
5. Press ◀ or ▶ to select your preference, [-2 - +2], and then press **OK**.

Related Information

- [Set Up Your Label Printer](#)

Turn the Backlight On/Off

Related Models: PT-D460BT

Save power by turning the backlight off.

The Backlight default setting is [On].

1. Press .
2. Press ◀ or ▶ to display [Settings], and then press **OK**.
3. Press ▲ or ▼ to display [Backlight], and then press **OK**.
4. Press ◀ or ▶ to select [On] or [Off], and then press **OK**.

NOTE

- The backlight automatically turns off if the machine is idle for a time you specify.
- The backlight turns off when printing.



Related Information

- [Set Up Your Label Printer](#)

Install Software

- [Install the Printer Driver and Software on a Computer \(Windows\)](#)
- [Connect the Label Printer to a Computer](#)

Install the Printer Driver and Software on a Computer (Windows)

To print from your Windows computer, install the printer driver and the Brother P-touch Editor software on your computer.

1. Open your preferred web browser and type install.brother in the address bar.

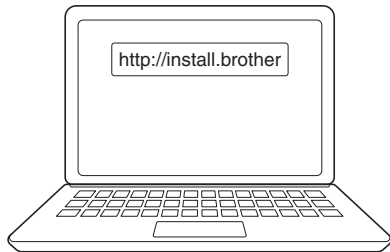

2. Click the **Download** button to download the Software/Documentation Installer.
3. Navigate to your computer's **Downloads** folder, double-click the downloaded installer file, and follow the on-screen instructions.

NOTE

- When you connect the Label Printer to your computer using Bluetooth, make sure you set the Bluetooth data transfer setting in your operating system to bi-directional. (PT-D460BT)
- Press the required button on the Label Printer for pairing when you confirm the passcode.



Related Information

- [Install Software](#)
 - [Available Applications](#)

Available Applications

Windows

Application	Features
P-touch Editor	Allows you to design and print custom labels using built-in drawing tools to create various font and text styles, import images, and insert barcodes.
P-touch Update Software ¹	Updates software and firmware to the latest version.

¹ Available with the USB connection only.

Mac

Application	Features
P-touch Editor	Allows you to design and print custom labels using built-in drawing tools to create various font and text styles, import images, and insert barcodes.
Transfer Express ¹	Updates firmware to the latest version.

¹ Available with the USB connection only.



Related Information

- [Install the Printer Driver and Software on a Computer \(Windows\)](#)

Connect the Label Printer to a Computer

- [Connect the Label Printer to a Computer Using a USB Cable](#)

Connect the Label Printer to a Computer Using a USB Cable

1. Make sure the Label Printer is turned off before connecting the USB cable.
2. Connect the USB cable to the USB Port on the Label Printer, and then to your computer.

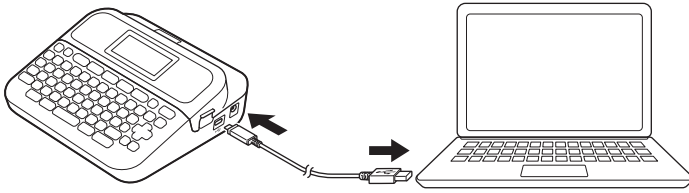

3. Turn the Label Printer on.



Related Information

- [Connect the Label Printer to a Computer](#)

Edit a Label

- [Add Text to Your Label](#)
- [Add a New Line of Text to Your Label](#)
- [Add a New Block of Text to Your Label](#)
- [Delete Text](#)
- [Insert a Tab](#)
- [Use Text Reminder to Autocomplete Common Words](#)
- [Enter Symbols](#)
- [Enter Accented Characters](#)
- [Set Character Attributes](#)
- [Set Label Length](#)
- [Use Auto Format Layouts](#)
- [Use Block Layouts](#)
- [Create a Barcode Label](#)

Add Text to Your Label

Related Models: PT-D460BT

1. Press .
2. Press ◀ or ▶ to display [Create Label], and then press **OK**.
3. Type the text or symbols you want (up to 280 alphanumeric characters, including spaces and punctuation marks).



Related Information

- [Edit a Label](#)

Add a New Line of Text to Your Label

You can add up to five lines to your labels, depending on the tape you are using. For more information, see *Related Topics*.

>> [PT-D410](#)

>> [PT-D460BT](#)

PT-D410

1. Move the cursor to the end of the current line.
2. Press .

Line 1

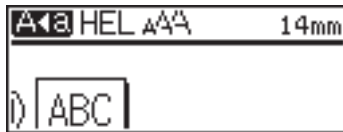

Line 2

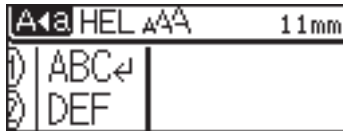

Printed Label Result



The maximum number of lines you can add depends on the tape width.

PT-D460BT

1. Move the cursor to the end of the current line.
2. Press .

Line 1



Line 2

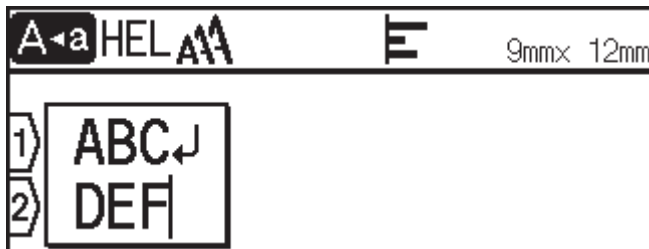

Printed Label Result

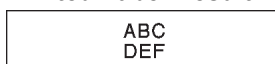

The maximum number of lines you can add depends on the tape width.



Related Information

- [Edit a Label](#)

Related Topics:

- [Specifications](#)
-

Add a New Block of Text to Your Label



>> PT-D410

>> PT-D460BT

PT-D410

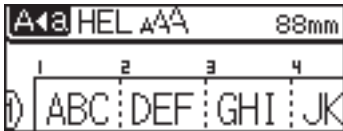
To print labels with multiple, but separate, sections of text, you can insert up to five different text blocks within the same label.



To add a new block of either text or blank lines to the right of your current text, press and hold , and then press  simultaneously.

The cursor moves to the start of the new block.





- To change the character attributes for a block of text, follow the steps for changing character attributes for a line of text.
- There is a maximum of five blocks per label.

PT-D460BT

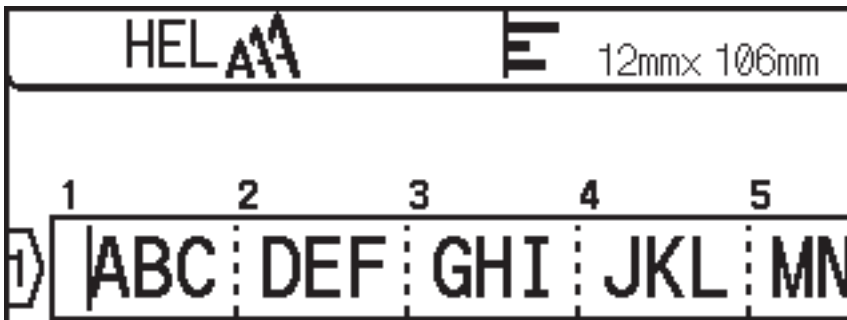
To print labels with multiple, but separate, sections of text, you can insert up to five different text blocks within the same label.



To add a new block of either text or blank lines to the right of your current text, press and hold , and then press  simultaneously.

The cursor moves to the start of the new block.





- To change the character attributes for a block of text, follow the steps for changing character attributes for a line of text.
 - There is a maximum of five blocks per label.
-



Related Information

- [Edit a Label](#)
-

Delete Text

- >> To delete one character at a time:
- >> To delete text but not format settings:
- >> To delete all characters in a specific line:
- >> To delete all characters and all format settings:



To delete one character at a time:

Press .

To delete text but not format settings:

1. Press .
2. Press **▲** or **▼** to display [Text Only], and then press **OK**.

To delete all characters in a specific line:

1. Press **▲** or **▼** to move to the line you want to delete.
2. Press  and  simultaneously.



To delete all characters and all format settings:

1. Press .
2. Press **▲** or **▼** to display [Text & Format], and then press **OK**.

Related Information

- [Edit a Label](#)

Insert a Tab

To insert a tab, place the cursor to the left of the text, and press  and  simultaneously.

The tab symbol () appears on the LCD.



To delete a tab from a label:

Position the cursor to the right of the tab symbol on the text entry screen, and then press .



Related Information

- [Edit a Label](#)
- [Change the Tab Length](#)

Change the Tab Length



>> [PT-D410](#)

>> [PT-D460BT](#)

PT-D410

1. Enter the text you want.
2. Press .
3. Press ▲ or ▼ to display [Tab Length].
4. Do one of the following:
 - Press ◀ or ▶ to display 0 - 100 mm, and then press **OK**.
 - Enter the tab length you want using the number keys. When finished, press **OK**.

PT-D460BT

1. Enter the text you want.
2. Press .
3. Press ▲ or ▼ to display [Tab Length], and then press **OK**.
4. Do one of the following:
 - Press ▲ or ▼ to display 0 - 100 mm, and then press **OK**.
 - Enter the tab length you want using the number keys. When finished, press **OK**.
5. Press  to return to the text entry screen.

Related Information

- [Insert a Tab](#)

Use Text Reminder to Autocomplete Common Words

Related Models: PT-D460BT

You can save frequently used text or phrases in your Label Printer for quick retrieval and use in your labels. By default, the Text Reminder feature is set to [On].

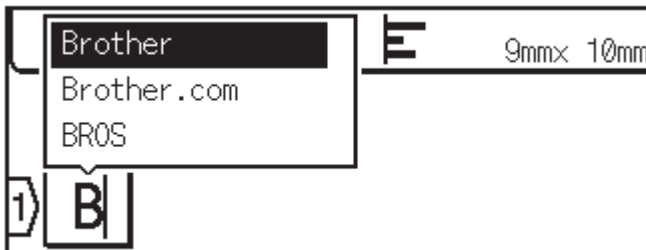

1. Type a character (for example: "B").
2. Press **OK**.
The Label Printer displays a list of previously used words beginning with the letter "B", such as "Brother".
3. Press **▲** or **▼** to select the word you want.
4. Press **▶** to display the entire word if necessary.
Press **◀** to return to the list of words.
5. Press **OK**.

To close the list of words and return to the text entry screen, press **Esc**.

✓ Related Information

- [Edit a Label](#)
 - [Clear Text Reminder Memory](#)
 - [Enable or Disable Text Reminder](#)

Clear Text Reminder Memory

Related Models: PT-D460BT

1. Press .
2. Press ◀ or ▶ to display [Settings], and then press **OK**.
3. Press ▲ or ▼ to display [Text Reminder], and then press **OK**.
4. Press ▲ or ▼ to display [Clear Memory], and then press **OK**.
The message [Clear all Text Reminder memory?] appears.
5. Press **OK**.



Related Information

- [Use Text Reminder to Autocomplete Common Words](#)

Enable or Disable Text Reminder

Related Models: PT-D460BT

1. Press .
2. Press ◀ or ▶ to display [Settings], and then press **OK**.
3. Press ▲ or ▼ to display [Text Reminder], and then press **OK**.
4. Press ▲ or ▼ to select [On/Off], and then press **OK**.
5. Press ▲ or ▼ to select [On] or [Off], and then press **OK**.



Related Information

- [Use Text Reminder to Autocomplete Common Words](#)

Enter Symbols

- [Enter Symbols Using the Symbol Function](#)
- [Set Symbol History](#)
- [Symbol Options](#)

Enter Symbols Using the Symbol Function

1. Press .
2. Press ▲ or ▼ to select a category, and then press **OK**.
3. Press ▲, ▼, ◀, or ▶ to select a symbol, and then press **OK**.



Related Information

- [Enter Symbols](#)
-

Set Symbol History

The Symbol History can store up to 30 recently used symbols. By default, the Symbol History feature is set to [On].

>> [PT-D410](#)

>> [PT-D460BT](#)

PT-D410

1. Press .
2. Press ▲ or ▼ to display [Symbol History], and then press **OK**.
3. Press ▲ or ▼ to select [On] or [Off], and then press **OK**.

PT-D460BT

1. Press .
2. Press ◀ or ▶ to display [Settings], and then press **OK**.
3. Press ▲ or ▼ to display [Symbol History], and then press **OK**.
4. Press ▲ or ▼ to select [On] or [Off], and then press **OK**.



Related Information

- [Enter Symbols](#)

Category	Symbols
Event	
Vehicle	
Wardrobe	
Sport	
Family	
Emoji	
Pictograph	
Astrology	

PT-D460BT

Category	Symbols
Punctuation	
Bracket/Arrow	
Mathematics	
Currency Unit	
(Number)	
[Number]	
Sign	
Electronics	

Category	Symbols
Business	
Medicine	
Electrical	
DIY/Hobby	
Garden	
Music	
Animal	
Kitchen	
Nature/Earth	
Event	
Vehicle	
Wardrobe	
Sports	
Emoji	
Pictograph	
Astrology	



Related Information

- [Enter Symbols](#)

Enter Accented Characters

>> [PT-D410](#)

>> [PT-D460BT](#)

PT-D410

1. Enter the character you want.
2. Press .
3. Press ◀ or ▶ to select the accented character, and then press **OK**.



Caps mode can be used with the Accent function.

PT-D460BT

1. Enter the character you want.
2. Press .
3. Press ▲ or ▼ to select the accented character, and then press **OK**.



Related Information

- [Edit a Label](#)
 - [Accented Character Options](#)

Accented Character Options

The accented characters displayed on the LCD depend on your language.

Character	Accented Characters
a	á à â ä æ ã å ä ã
A	Á À Â Ä Æ Ã Å Ä Æ
c	ç ċ ċ
C	Ç Ć Ć
d	d' ð đ
D	Ď Ď
e	é è ê ë ě ě è ē
E	É È Ê Ë Ě Ě Ě Ě
g	ğ ğ
G	Ĝ Ğ
i	í ì î ï ĵ ĵ ĵ
I	Í Ì Î Ï Ĵ Ĵ Ĵ
k	ķ
K	Ķ
l	ł ł ł ł
L	Ł Ł Ł Ł
n	ñ ñ ñ ñ
N	Ñ Ñ Ñ Ñ
o	ó ò ô ø ö õ œ ö
O	Ó Ò Ô Ø Ö Õ Œ Ö
r	ř ř ř
R	Ř Ř Ř
s	š š š š ß
S	Š Š Š Š ß
t	t' t t
T	Ť Ť Ť

Character	Accented Characters
u	ú ù û ü ů ū ů
U	Ú Ù Û Ü Ů Ū Ů
y	ý ÿ
Y	Ý Ÿ
z	ž ź ž
Z	Ž Ž Ž



Related Information

- [Enter Accented Characters](#)

Set Character Attributes

You can set character attributes by label or per line.

- [Apply Character Attributes to a Character](#)
- [Apply Character Attributes to a Line of Text](#)
- [Attribute Setting Options](#)
- [Set Auto Fit Style](#)

Apply Character Attributes to a Character

When formatting your text, you can preview your character attribute selections on the LCD.



>> [PT-D410](#)

>> [PT-D460BT](#)

PT-D410

1. Type the text you want.
2. Press .
3. Press ▲ or ▼ to select an attribute.
4. Press ◀ or ▶ to set a value for that attribute.

PT-D460BT

1. Type the text you want.
2. Press .
3. Press ▲ or ▼ to select an attribute, and then press **OK**.
4. Press ▲ or ▼ to set a value for that attribute, and then press **OK**.
5. Press  to return to the text entry screen.



Related Information

- [Set Character Attributes](#)

Related Topics:

- [Attribute Setting Options](#)



Apply Character Attributes to a Line of Text

If you add multiple lines in your label, you can format each line of text to look different.

>> [PT-D410](#)

>> [PT-D460BT](#)

PT-D410

1. Type the lines of characters or text you want on your label.
2. Press ▲ or ▼ to move the cursor to the line whose character attributes you want to change.
3. Press  and  to display the available formatting attributes.

Three black lines in the upper right corner of the LCD indicate that you are now applying the attribute to that specific line only.



4. Press ▲ or ▼ to select an attribute.
5. Press ◀ or ▶ to set a value for that attribute, and then press **OK**.





- When different attribute values are set for each line, the value appears as ***** when you press





- When different attribute values are set for each line, the line numbers on the text entry screen are displayed as white text on a black background.

PT-D460BT

1. Type the lines of characters or text you want on your label.
2. Press ▲ or ▼ to move the cursor to the line whose character attributes you want to change.
3. Press  and  to display the available formatting attributes.

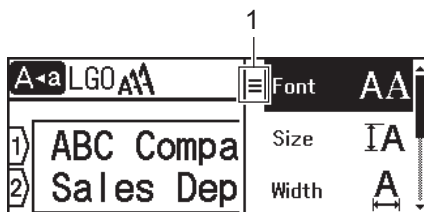
Three black lines (1) on the left side of the character attribute indicate that you are now applying the attribute to that specific line only.



4. Press ▲ or ▼ to select an attribute, and then press **OK**.
5. Press ▲ or ▼ to set a value for that attribute, and then press **OK**.
6. Press  to return to the text entry screen.



When different attribute values are set for each line, each line's values appear as three black lines (1), also called a 'hamburger menu', when you press .

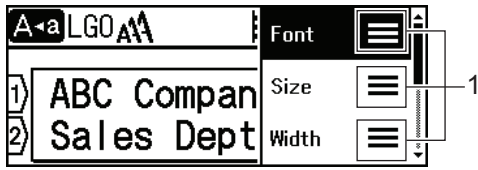

Related Information

- [Set Character Attributes](#)

Related Topics:

- [Attribute Setting Options](#)

Attribute Setting Options

Font

Value	LCD Message	Result
Helsinki	HEL	A1
Dortmund	DTM	A1
Brussels	BRU	A1
Atlanta	ATL	A1
US	US	A1
Los Angeles	LA	A1
San Diego	SGO	A1
Florida	FLO	A1
Calgary	CAL	<i>A1</i>
Belgium	BEL	A1
Adams	ADM	A1
Brunei	BRN	A1
Sofia	SOF	A1
Germany	GER	<i>A1</i>
Letter Gothic	LGO	A1
Istanbul (PT-D460BT)	IST	A1

Font Size

Available Sizes:

Auto, 6 pt, 9 pt, 12 pt, 18 pt, 24 pt, 36 pt, 42 pt



When Auto is selected, the text is automatically adjusted to print in the largest size available in the font settings for each tape width.

Width

Value	Result
x 1	A
x 3/2	A
x 2	A

Value	Result
x 1/2	A
x 2/3	A

Font Style

Value	LCD Message	Result
Normal	Normal	A
Bold	BLD	A
Underline	UND	<u>A</u>
Underline Bold (PT-D460BT)	UND+BLD	<u>A</u>
Strikeout	STR	A
Outline	OUT	A
Shadow	SHD	A
Solid	SLD	A
Italic	ITA	<i>A</i>
Italic Bold	I+BLD	<i>A</i>
Italic Outline	I+OUT	<i>A</i>
Italic Shadow	I+SHD	<i>A</i>
Italic Solid	I+SLD	<i>A</i>
Vertical	VERT	A
Vertical Bold (PT-D460BT)	VERT+BLD	A

Alignment

Value	Result
Left	ABC
Centre	ABC
Right	ABC
Justify	A B C



Related Information

- [Set Character Attributes](#)

Set Auto Fit Style

You can reduce the text size to fit within the length of your label.

>> [PT-D410](#)

>> [PT-D460BT](#)

PT-D410

1. Press .
2. Press **▲** or **▼** to display [Auto Fit Style], and then press **OK**.
3. Press **▲** or **▼** to select one of following options:

Option	Description
Text Size	The total text size is reduced to fit within the label.
Text Width	The text width is reduced to the size of the $\times 1/2$ or $\times 2/3$ setting to fit within the label. For the expected output, see <i>Related Topics</i> .

4. Press **OK**.

PT-D460BT

1. Press .
2. Press **◀** or **▶** to display [Settings], and then press **OK**.
3. Press **▲** or **▼** to display [Auto Fit Style], and then press **OK**.
4. Press **▲** or **▼** to select one of following options:

Option	Description
Text Size	The total text size is reduced to fit within the label.
Text Width	The text width is reduced to the size of the $\times 1/2$ or $\times 2/3$ setting to fit within the label. For the expected output, see <i>Related Topics</i> .

5. Press **OK**.

Related Information

- [Set Character Attributes](#)

Related Topics:

- [Attribute Setting Options](#)

Set Label Length

Labels can be between 30 mm and 300 mm in length. When you select [Auto], the label length is automatically adjusted based on the amount of text entered.



>> [PT-D410](#)

>> [PT-D460BT](#)

PT-D410

1. Press .
2. Press ▲ or ▼ to select [Length].
3. Press ◀ or ▶ to set a value, and then press **OK**.

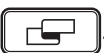
PT-D460BT

1. Press .
2. Press ▲ or ▼ to display [Length], and then press **OK**.
3. Do one of the following:
 - Press ▲ or ▼ to set a value, and then press **OK**.
 - Set the label length by typing in the length you want using the number keys. When finished, press **OK**.
4. Press  to return to the text entry screen.



Related Information

- [Edit a Label](#)
 - [Set Frames](#)

Related Topics:

- [Change the Tab Length](#)
- [Select a Cut Option](#)

Set Frames

>> PT-D410

>> PT-D460BT

PT-D410

1. Press .
2. Press ▲ or ▼ to select a category, and then press **OK**.
3. Press ▲, ▼, ◀, or ▶ to select a frame, and then press **OK**.

PT-D460BT

1. Press .
2. Press ▲ or ▼ to select a category, and then press **OK**.
3. Press ▲, ▼, ◀, or ▶ to select a frame, and then press **OK**.



You can also select a frame by entering its number. For more information, see *Related Information*.

✓ Related Information

- [Set Label Length](#)
 - [Frame Options](#)
 - [Frame Options](#)

Frame Options

Related Models: PT-D410

Category	Frames
Simple 1	
Simple 2	
Decorative	
Business	

✓ Related Information

- [Set Frames](#)

Frame Options

Related Models: PT-D460BT

Category	Frames
Simple 1	
Simple 2	
Decorative	
Business 1	
Business 2	

✓ Related Information

- [Set Frames](#)

Use Auto Format Layouts

- [Use Templates](#)
- [Template Options](#)
- [Template Options](#)

Use Templates

Select a layout from the preloaded templates included with your Label Printer, enter your text, and then apply any formatting you want. For preloaded templates, see *Related Topics: Template Options*.



If the width of the current Tape Cassette does not match the set width for the selected template, an error message appears when you try to print the label. Press  or any other key to clear the error message, and then insert the correct Tape Cassette or choose a different template.

- >> PT-D410
- >> PT-D460BT

PT-D410

Example - To customise and print the preloaded template named Asset Tag 1:



1. Press .
2. Press **▲** or **▼** to display [Templates], and then press **OK**.
3. Press **▲** or **▼** to display [Asset Management], and then press **OK**.
4. Press **▲** or **▼** to display [Asset Tag 1], and then press **OK**.
5. Press **▲**, **▼**, **◀**, or **▶** to select a text attribute, and then press **OK**.
6. Press **▲**, **▼**, **◀**, or **▶** to select a barcode attribute, and then press **OK**.
7. Enter the text you want, and then press **OK**.
8. Enter the text for the next field, and then press **OK**.
9. Enter the barcode data, and then press **OK**. For more information, see *Related Topics: Create a Barcode Label*.
10. Do one of the following:

- Select [Print], and then press **OK**.
- Press **▲** or **▼** to select one of the following options:



Option	Description
Edit	Change the text.
Save	Save the label. For more information, see <i>Related Topics: Use the File Memory</i> .
Cancel	Cancel the template printing.
Preview	Preview the label before printing.
Print Options	Select print options. For more information, see <i>Related Topics: Print Labels</i> .

11. Press **▲** or **▼** to select the number of labels you want to print, and then press  or **OK**.

Example - To customise and print the preloaded template named Asset Tag 1:



1. Press .
2. Press **◀** or **▶** to display [Auto Format], and then press **OK**.
3. Press **▲** or **▼** to display [Templates], and then press **OK**.
4. Press **▲** or **▼** to display [Asset Management], and then press **OK**.
5. Press **▲** or **▼** to display [Asset Tag 1], and then press **OK**.
6. Enter the text you want, and then press **OK**.
7. Enter the text for the next field, and then press **OK**.
8. Press **▲**, **▼**, **◀**, or **▶** to select a barcode attribute, and then press **OK**.
9. Enter the barcode data, and then press **OK**. For more information, see *Related Topics: Create a Barcode Label*.
10. Do one of the following:
 - Select [Print], and then press **OK**.
 - Press **▲** or **▼** to select one of the following options:



Option	Description
Edit	Change the text.
Save	Save the label. For more information, see <i>Related Topics: Use the File Memory</i> .
Menu	Change the Font or Style settings.
Preview	Preview the label before printing.
Print Options	Select print options. For more information, see <i>Related Topics: Print Labels</i> .

11. Press **▲** or **▼** to select the number of labels you want to print, and then press  or **OK**.

Related Information













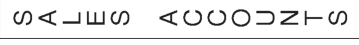

- [Use Auto Format Layouts](#)

Related Topics:

- [Create a Barcode Label](#)
- [Use the File Memory](#)
- [Print Labels](#)
- [Template Options](#)

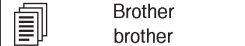
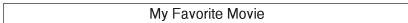
Template Options

Related Models: PT-D410













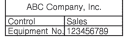

Category	Value	Details
Asset Management	Asset Tag 1	 (18 mm x 70 mm)
	Asset Tag 2	 (18 mm x 70 mm)
	Asset Tag 3	 (18 mm x 70 mm)
	Equipment Label	 (18 mm x 58 mm)
File/Cabinet	Binder Spine 1	 (18 mm x 219 mm)
	Binder Spine 2	 (12 mm x 219 mm)
	File Folder Tab	 (12 mm x 82 mm)
	Divider Tab	 (12 mm x 42 mm)
	Cabinet Label	 (18 mm x 111 mm)
Address/ID	Address Label	 (18 mm x 70 mm)
	Name Badge	 (18 mm x 72 mm)
Media	DVD Case Spine	 (9 mm x 178 mm)
	SD Card Label	 (12 mm x 25 mm)
	USB Flash Memory	 (9 mm x 25 mm)
Cable Labelling	Flag	 (12 mm x 90 mm)



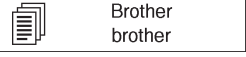

✓ Related Information

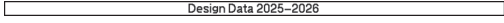
- [Use Auto Format Layouts](#)

Template Options

Related Models: PT-D460BT

Category	Value	Details
Asset Management	Asset Tag 1	 (18 mm x 70 mm)
	Asset Tag 2	 (18 mm x 70 mm)
	Asset Tag 3	 (18 mm x 70 mm)
	Asset Tag 4	 (12 mm x 70 mm)
	Bin Box	 (18 mm x 76 mm)
	Equipment Label	 (18 mm x 58 mm)
File/Cabinet	Binder Spine	 (18 mm x 219 mm)
	File Folder Tab	 (12 mm x 82 mm)
	Divider Tab	 (12 mm x 42 mm)
	Cabinet Label	 (18 mm x 111 mm)
Address/ID	Address Label	 (18 mm x 70 mm)
	Name Badge 1	 (18 mm x 72 mm)
	Name Badge 2	 (18 mm x 72 mm)
Media	CD Case Spine 1	 (6 mm x 113 mm)
	CD Case Spine 2	 (3.5 mm x 113 mm)
	DVD Case Spine	 (9 mm x 178 mm)
	SD Card Label	

Category	Value	Details
		(12 mm x 25 mm)
	USB Flash Memory	 (9 mm x 25 mm)
Cable Labelling	Flag 1	 (12 mm x 90 mm)
	Flag 2	 (12 mm x 90 mm)
	Cable Wrap	 (18 mm x 39 mm)
	Faceplate (VRT)	 (12 mm x 70 mm)



Related Information

- [Use Auto Format Layouts](#)

Use Block Layouts

You can choose different Block Layouts, based on the tape size, to arrange text lines on your label. Select one of the Block Layout options, enter your text, and then apply text formatting if needed. To see what options are available for the tape you are using, see *Related Information: Block Layout Options*.

>> [PT-D410](#)

>> [PT-D460BT](#)

PT-D410

Example - Asset Tag 1:



1. Press .
2. Press **▲** or **▼** to display [Block Layouts], and then press **OK**.
3. Press **▲** or **▼** to select the tape width you want, and then press **OK**.
4. Press **▲** or **▼** to select the block layout you want, and then press **OK**.
5. Press **▲**, **▼**, **◀**, or **▶** to select a text attribute, and then press **OK**.
6. Enter the text you want, and then press **OK**.
7. Repeat these steps for each text field, and then press **OK**.
8. Press **OK** to display the print menu.
9. Do one of the following:

- Select [Print], and then press **OK**.
- Press **▲** or **▼** to select one of the following options:



Option	Description
Edit	Change the text.
Save	Save the label. For more information, see <i>Related Topics: Use the File Memory</i> .
Cancel	Cancel the template printing.
Preview	Preview the label before printing.
Print Options	Select print options. For more information, see <i>Related Topics: Print Labels</i> .

10. Press **▲** or **▼** to select the number of labels you want to print, and then press  or **OK**.



If the width of the current Tape Cassette does not match the set width for the selected layout, an error message appears when you try to print the label. Press  or any other key to clear the error message, and then insert the correct Tape Cassette.

PT-D460BT

1. Press .

2. Press ◀ or ▶ to display [Auto Format], and then press **OK**.
3. Press ▲ or ▼ to display [Block Layouts], and then press **OK**.
4. Press ▲ or ▼ to select the tape width you want, and then press **OK**.
5. Press ▲ or ▼ to select the block layout you want, and then press **OK**.
6. Enter the text you want, and then press **OK**.
7. Repeat these steps for each text field, and then press **OK**.
8. Press **OK** to display the print menu.
9. Do one of the following:
 - Select [Print], and then press **OK**.
 - Press ▲ or ▼ to select one of the following options:

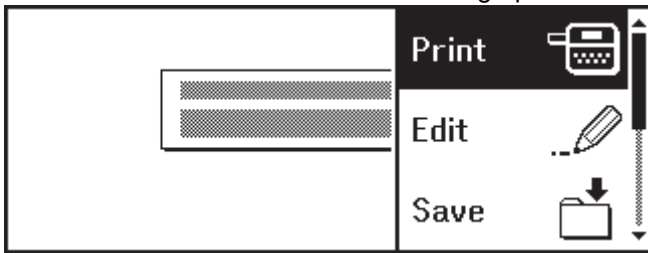

Option	Description
Edit	Change the text.
Save	Save the label. For more information, see <i>Related Topics: Use the File Memory</i> .
Menu	Change the Font, Align, or Frame settings.
Preview	Preview the label before printing.
Print Options	Select print options. For more information, see <i>Related Topics: Print Labels</i> .

10. Press ▲ or ▼ to select the number of labels you want to print, and then press  or **OK**.



If the width of the current Tape Cassette does not match the set width for the selected layout, an error message appears when you try to print the label. Press  or any other key to clear the error message, and then insert the correct Tape Cassette.

✓ Related Information

- [Edit a Label](#)
 - [Block Layout Options](#)
 - [Block Layout Options](#)









Related Topics:

- [Use the File Memory](#)
- [Print Labels](#)

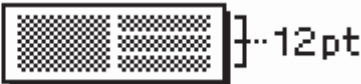

Block Layout Options

Related Models: PT-D410

18 mm Tape



Value	Details
2LineA	 ... 12pt ... 24pt
2LineB	 ... 24pt ... 12pt
3Line	 9pt 9pt ... 24pt
1+1Line	42pt...  ... 18pt
1+2LineA	42pt...  ... 18pt ... 18pt
1+2LineB	42pt...  ... 18pt ... 18pt
1+3Line	42pt...  } ... 12pt
1+4Line	24pt...  } ... 9pt

12 mm Tape

Value	Details
2LineC	 9pt ... 12pt
2LineD	 ... 12pt 9pt
1+1Line	24pt...  ... 12pt

Value	Details
1+2Line	24pt...  ... 12pt ... 12pt

9 mm Tape

Value	Details
2LineE	 6pt 12pt
1+2Line	18pt...  9pt 9pt

6 mm Tape

Value	Details
1+2Line	12pt...  6pt 6pt











Related Information

- [Use Block Layouts](#)





Block Layout Options

Related Models: PT-D460BT

18 mm Tape



Value	Details
2LineA	 ... 12pt ... 24pt
2LineB	 ... 24pt ... 12pt
3Line	 9pt 9pt ... 24pt
1+1Line	42pt...  ... 18pt
1+2LineA	42pt...  ... 18pt ... 18pt
1+2LineB	42pt...  ... 12pt ... 24pt
1+3Line	42pt...  } ... 12pt
1+4Line	24pt...  } ... 9pt
1+5Line	24pt...  } ... 9pt

12 mm Tape

Value	Details
2LineA	 9pt ... 12pt
2LineB	 ... 12pt 9pt
3Line	 6pt 6pt ... 12pt
1+1Line	24pt...  ... 12pt

Value	Details
1+2Line	24pt...  ... 12pt ... 12pt

9 mm Tape

Value	Details
2LineA	 6pt 12pt
2LineB	 ... 12pt 6pt
1+2Line	18pt...  9pt 9pt

6 mm Tape

Value	Details
1+2Line	12pt...  6pt 6pt



Related Information

- [Use Block Layouts](#)

Create a Barcode Label

- [Create and Print Barcodes](#)
- [Edit or Delete a Barcode and Barcode Data](#)

Create and Print Barcodes

The Label Printer is not designed exclusively for creating barcode labels. Always check that barcode labels can be read by the barcode reader.

For best results, print barcode labels in black ink on white tape. Some barcode readers may not be able to read barcode labels created using coloured tape or ink.

Up to five barcodes can be printed on a label.



NOTE

- Use the [Large] setting for [Width] whenever possible. Some barcode readers may not be able to read barcode labels created using the [Small] setting.
- Continuously printing a large number of labels with barcodes can overheat the Print Head, which may affect the print quality.
- Symbols are available only for the CODE39, CODE128, CODABAR, or GS1-128 protocols.
- The "C.Digit" (Check Digit) attribute is available only for the CODE39, I-2/5, and CODABAR protocols.



>> [PT-D410](#)

>> [PT-D460BT](#)

PT-D410

1. Press .
2. Press **▲** or **▼** to display [Barcode Setup], and then press **OK**.
3. Press **▲** or **▼** to select an attribute.
4. Press **◀** or **▶** to set a value for that attribute, and then press **OK**.
5. Enter the barcode data. For more information, see *Related Topics*.
6. Press .
7. Press **▲** or **▼** to select a character, and then press **OK**.
8. Press **OK**.

PT-D460BT

1. Press .
2. Press **▲**, **▼**, **◀**, or **▶** to select an attribute, and then press **OK**.
3. Enter the barcode data. For more information, see *Related Topics*.
4. Press .
5. Press **▲** or **▼** to select a character, and then press **OK**.
6. Press **OK**.

Related Information

- [Create a Barcode Label](#)
 - [Barcode Options](#)

Barcode Options

Attribute	Value
Protocol	CODE39, CODE128, EAN-8, EAN-13, GS1-128 (UCC/EAN-128), UPC-A, UPC-E, I-2/5 (ITF), CODABAR
Width	Small
	Large
Under# (Characters printed below the barcode)	On
	Off
C.Digit (Check Digit)	Off
	On (Available only for the CODE39, I-2/5, and CODABAR protocols)

Special Character Options

CODE39

Special Character
—
.
(SPACE)
\$
/
+
%

CODABAR

Special Character
—
\$
:
/
.

Special Character
+

CODE128, GS1-128 (UCC / EAN-128)

Special Character			
(SPACE)	!	"	#
\$	%	&	'
()	*	+
,	-	.	/
:	;	<	=
>	?	@	[
\]	^	_
NUL	·	SOH	STX
ETX	EOT	ENQ	ACK
BEL	BS	HT	LF
VT	FF	CR	SO
SI	DLE	DC1	DC2
DC3	DC4	NAK	SYN
ETB	CAN	EM	SUB
ESC	{	FS	
GS	}	RS	~
US	DEL	FNC3	FNC2
FNC4	FNC1		



Related Information

- [Create and Print Barcodes](#)

Edit or Delete a Barcode and Barcode Data

>> [Delete a barcode from a label](#)

>> [Edit Barcode Data](#)

Delete a barcode from a label

1. Position the cursor to the right of the barcode on the data entry screen.
2. Press .

Edit Barcode Data

>> [PT-D410](#)

>> [PT-D460BT](#)

PT-D410

1. To edit barcode attributes and barcode data, position the cursor under the barcode on the data entry screen.
2. Press  to open the Barcode Setup screen.
3. Press **▲** or **▼** to display [Barcode Setup], and then press **OK**.

PT-D460BT

1. To edit barcode attributes and barcode data, position the cursor to the left of the barcode on the data entry screen.
2. Press  to open the Barcode Setup screen.

Related Information

- [Create a Barcode Label](#)

Print Labels

- [Preview Labels](#)
- [Print Labels](#)
- [Select a Cut Option](#)
- [Adjust the Label Length](#)

Preview Labels

You can preview labels before printing to make sure they are correct.



>> [PT-D410](#)

>> [PT-D460BT](#)

PT-D410

1. Press .
2. Do one of the following:
 - Press ◀ or ▶ to scroll the preview left or right.
 - Press ▲ or ▼ to zoom the preview in and out.

PT-D460BT

1. Press .
2. Do one of the following:
 - Press ◀, ▶, ▲, or ▼ to scroll the preview left, right, up, or down.
 - Press  and ◀, ▶, ▲, or ▼ to scroll directly to the left, right, top, or bottom border.
 - Press  to zoom the preview in and out.



Related Information

- [Print Labels](#)

Print Labels

To cut off the label, press the Tape Cutter Lever on the upper left corner of the Label Printer.

NOTE

- To prevent damage to the tape, do not touch or press the Cutter Lever while the message [Printing... copies] or [Feeding tape... Please wait] appears on the LCD.
- Do not pull the label when the Label Printer is ejecting it from the Tape Exit Slot. Doing so will cause the ink ribbon to be discharged with the tape, making the tape unusable.
- Do not block the Tape Exit Slot during printing. Doing so will cause the tape to jam.

1. After creating your label, press .
2. Press ▲ or ▼ to change the number of copies, and then press  or **OK**.



- You can also specify the number of copies using the number keys.
- If you need only one copy of the label, press  without selecting the number of copies.



Related Information

- [Print Labels](#)
 - [Sequential Printing](#)
 - [Mirror Printing](#)

Sequential Printing

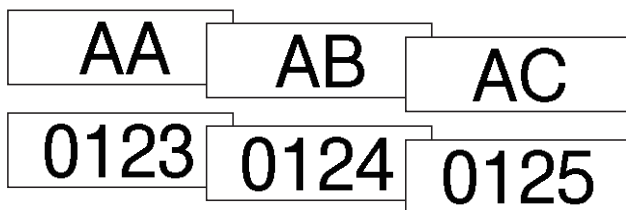

Use this function to create labels with sequentially arranged numbers or letters, from a single label format.





>> [PT-D410](#)

>> [PT-D460BT](#)

PT-D410

1. Press  and .
2. Press ▲ or ▼ to display [Numbering], and then press **OK**.
3. Press ◀ or ▶ to select the start point, and then press **OK**.
4. Press ◀ or ▶ to select the end point, and then press **OK**.
5. Press ▲ or ▼ to select the number of labels you want to print, and then press  or **OK**.

PT-D460BT

1. Press  and .
2. Press ▲ or ▼ to display [Number], and then press **OK**.
3. Press ◀ or ▶ to select the start point, and then press **OK**.
4. Press ◀ or ▶ to select the end point, and then press **OK**.
5. Press ▲ or ▼ to select the number of labels you want to print, and then press  or **OK**.

✓ Related Information

- [Print Labels](#)

Mirror Printing

>> [PT-D410](#)

>> [PT-D460BT](#)

PT-D410

Use clear tape in [Mirror], so the labels can be read correctly from the opposite side when attached to glass, windows, or other transparent surfaces.

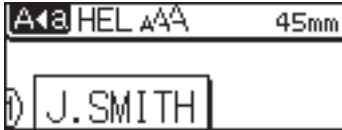

J. SMITH

1. Press  and .
2. Press  or  to select [Mirror], and then press **OK**.
3. Press  or **OK**.

PT-D460BT

Use clear tape in [Mirror], so the labels can be read correctly from the opposite side when attached to glass, windows, or other transparent surfaces.



J. SMITH

1. Press  and .
2. Press  or  to select [Mirror], and then press **OK**.
3. Press  or **OK**.

Related Information

- [Print Labels](#)

Select a Cut Option

Choose from several built-in options to determine how the Label Printer cuts your labels.

>> [PT-D410](#)

>> [PT-D460BT](#)

PT-D410

1. Press .
2. Press ▲ or ▼ to select [Cut Option].
3. Press ◀ or ▶ to select [Small Margin], [Large Margin], [Chain], [No Cut], or [Special Tape], and then press **OK**.

PT-D460BT

1. Press .
2. Press ▲ or ▼ to display [Cut Option], and then press **OK**.
3. Press ▲ or ▼ to select [Small Margin], [Large Margin], [Chain], [No Cut], or [Special Tape], and then press **OK**.





Related Information

- [Print Labels](#)
- [Tape Cutting Options](#)

Tape Cutting Options

In the Options table, these visual patterns represent parts of your label, as illustrated in the Example column.

	Print area
	Margin
	Laminate margin

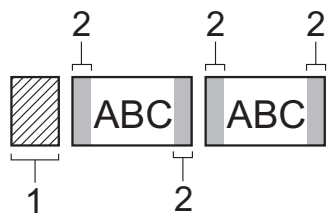
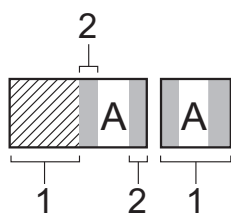
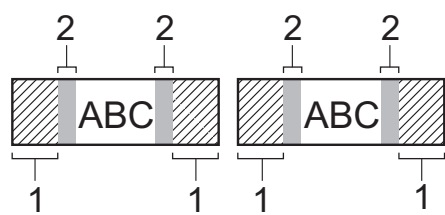
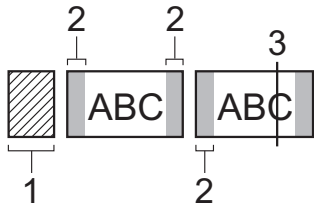
Setting	Description	Example
Small Margin	A margin of 23 mm is printed first, and then each label is printed, leaving a margin of 2 mm before and after the text.	<ul style="list-style-type: none"> When the label length is approximately 23 mm or more  <ol style="list-style-type: none"> Approximately 23 mm 2 mm When the label length is approximately 23 mm or less  <ol style="list-style-type: none"> Approximately 23 mm 2 mm
Large Margin	The total margin (laminate margin + label margin) is 25 mm either side of the label.	 <ol style="list-style-type: none"> Approximately 23 mm 2 mm
Chain	<ul style="list-style-type: none"> Select this setting when printing several labels with minimum margins. Feed the tape before using the Tape Cutter, otherwise part of the text may get cut off. Do not try to pull the tape as this may damage the Tape Cassette. A margin of 23 mm is printed first, and then each label is printed, leaving a margin of 2 mm before and after the text. 	 <ol style="list-style-type: none"> Approximately 23 mm 2 mm Cut Position

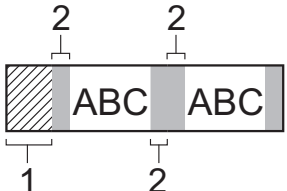
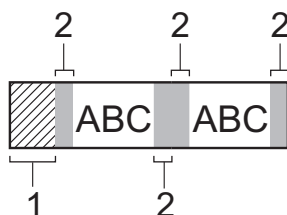
Setting	Description	Example
No Cut	<ul style="list-style-type: none"> Select this setting when printing multiple copies of a label, or when using Fabric Iron-On Tapes or other special tapes that cannot be cut by the Tape Cutter of the Label Printer. Feed the tape before using the Tape Cutter, otherwise part of the text may get cut off. Do not try to pull the tape as this may damage the Tape Cassette. When using the special tapes that cannot be cut by the Tape Cutter of the Label Printer, remove the Tape Cassette from the Label Printer and use scissors to cut the tape. 	 <ol style="list-style-type: none"> Approximately 23 mm 2 mm
Special Tape	Select this setting when using special tape.	 <ol style="list-style-type: none"> Approximately 23 mm 2 mm



- When the cut option is set to [No Cut] or [Chain], the cut position is set in the middle of printing area after the last label is printed. When [Start feeding?] appears on the LCD, press **OK** to feed the tape. Press **Esc** to return to the text entry screen.
- When the cut option is set to [Small Margin], [Large Margin], or [Chain], the message [Cut tape or press Enter to continue.] appears after printing, and the Label Printer enters Cut Pause Mode. By pressing the Tape Cutter Lever, you can cut the tape at the position you set in [Cut Option].



Related Information

- Select a Cut Option

Adjust the Label Length

When the Tape Cassette is almost empty, the printed label length may be less accurate. In this case, adjust the label length manually.









Approximately 1% of the total label length is adjusted by one level.









>> [PT-D410](#)

>> [PT-D460BT](#)

PT-D410

1. Press .
2. Press  or  to display [Adjustment], and then press **OK**.
3. Press  or  to select [Label Length].
4. Press  or  to display [-3 - +3], and then press **OK**.

PT-D460BT

1. Press .
2. Press  or  to display [Settings], and then press **OK**.
3. Press  or  to display [Adjustment], and then press **OK**.
4. Press  or  to display [Label Length], and then press **OK**.
5. Press  or  to display [-3 - +3], and then press **OK**.



Related Information

- [Print Labels](#)

Use the File Memory

- [Save Label Files](#)
- [Print, Open, and Delete a Saved Label](#)

Save Label Files

You can save up to 50 labels and recall them for printing at a later date. Each label file can contain a maximum of 80 (PT-D410) or 280 (PT-D460BT) characters. You can also edit and overwrite saved labels.

>> [PT-D410](#)

>> [PT-D460BT](#)

PT-D410

1. Enter the text and format your label.
2. Press .
3. Press ▲ or ▼ to display [Save], and then press **OK**.
4. Press ▲ or ▼ to select a file, and then press **OK**.

PT-D460BT

1. Enter the text and format your label.
2. Press .
3. Press ▲ or ▼ to select a file, and then press **OK**.

Related Information

- [Use the File Memory](#)

Print, Open, and Delete a Saved Label

>> PT-D410

>> PT-D460BT

PT-D410

1. Press .

2. Do one of the following:

Option	Description
Print	<p>a. Press ▲ or ▼ to display <i>Print</i>, and then press OK.</p> <p>b. Press ▲ or ▼ to select a file, and then press OK.</p> <p>c. Press ▲ or ▼ to change the number of copies, and then press  or OK.</p>
Open	<p>a. Press ▲ or ▼ to display <i>Open</i>, and then press OK.</p> <p>b. Press ▲ or ▼ to select a file, and then press OK.</p>
Delete	<p>a. Press ▲ or ▼ to display <i>Delete</i>, and then press OK.</p> <p>b. Press ▲ or ▼ to select a file, and then press OK.</p> <p>The <i>Delete?</i> message appears.</p> <p>c. Press OK.</p>



PT-D460BT

1. Press .

2. Press ◀ or ▶ to display [*File*], and then press **OK**.

3. Press ▲ or ▼ to select a file, and then press **OK**.

4. Do one of the following:

Option	Description
Print	<p>a. Press ▲ or ▼ to display <i>Print</i>, and then press OK.</p> <p>b. Press ▲ or ▼ to change the number of copies, and then press  or OK.</p>
Open	Press ▲ or ▼ to display <i>Open</i> , and then press OK .
Delete	<p>a. Press ▲ or ▼ to display <i>Delete</i>, and then press OK.</p> <p>b. Press OK.</p> <p>The <i>Delete?</i> message appears.</p> <p>c. Press OK.</p> <p>To delete a saved label from the file selection screen, select the label using ▲ or ▼, and then press .</p>

✓ Related Information

- [Use the File Memory](#)

Create and Print Labels Using Your Computer

- [Create Labels Using P-touch Editor \(Windows\)](#)
- [Create Labels and Print Using P-touch Editor \(Mac\)](#)
- [Print Labels Using the Printer Driver \(Windows\)](#)

Create Labels Using P-touch Editor (Windows)

To use your Label Printer with your Windows computer, install P-touch Editor and the printer driver on your computer.

For the latest drivers and software, go to your model's **Downloads** page on the Brother support website at support.brother.com.

1. Start P-touch Editor .

• **Windows 11:**

Click **Start > Brother P-touch > P-touch Editor**, or double-click the **P-touch Editor** icon on the desktop.

*Depending on your computer's operating system, the Brother P-touch folder may or may not be created.

• **Windows 10:**

Click **Start > Brother P-touch > P-touch Editor**, or double-click the **P-touch Editor** icon on the desktop.

• **Windows 8.1:**

Click the **P-touch Editor** icon on the **Apps** screen, or double-click the **P-touch Editor** icon on the desktop.

2. Do one of the following:

• To open an existing layout, click **Open** (4).

• To create a new layout, click the **New Label** tab and the **New Label** button (1).

• To create a new layout using a preset layout, click the **New Label** tab and click a category button (2), select a template, and then click **Create** (3).

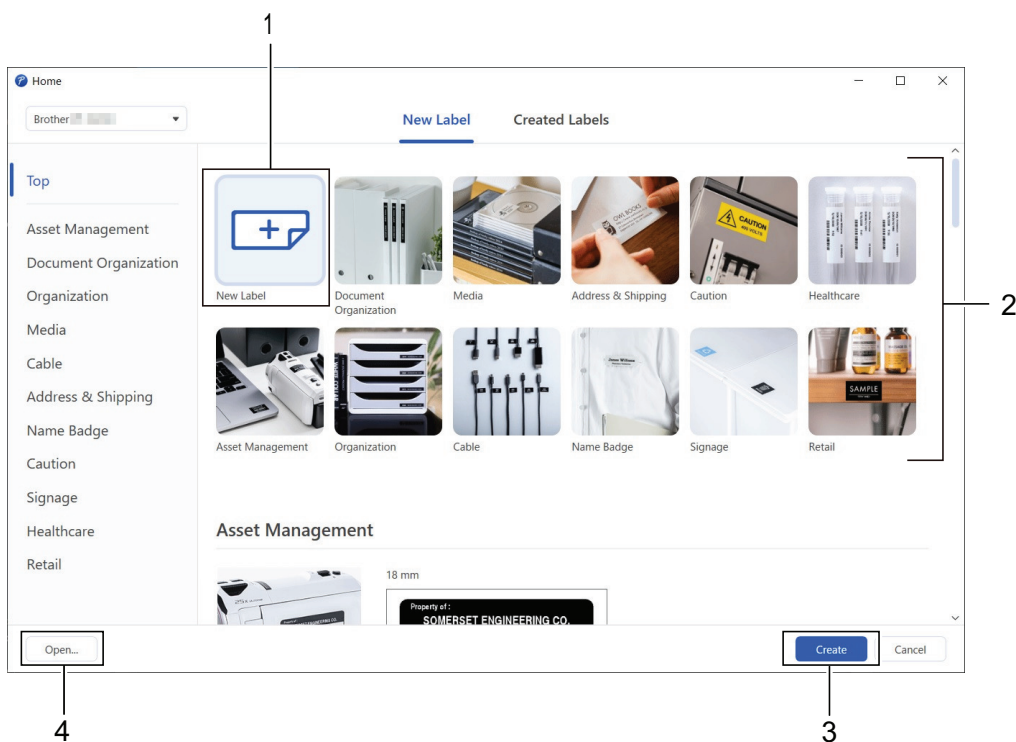

Related Information

- [Create and Print Labels Using Your Computer](#)

Create Labels and Print Using P-touch Editor (Mac)

Download and install P-touch Editor from the App Store on your Mac.

To use your Label Printer with your Mac computer, install P-touch Editor.

1. Double-click **Macintosh HD > Applications**, and then double-click the **Brother P-touch Editor** icon.
2. When P-touch Editor starts, click **New** to select a template, create a new layout, or open an existing layout.

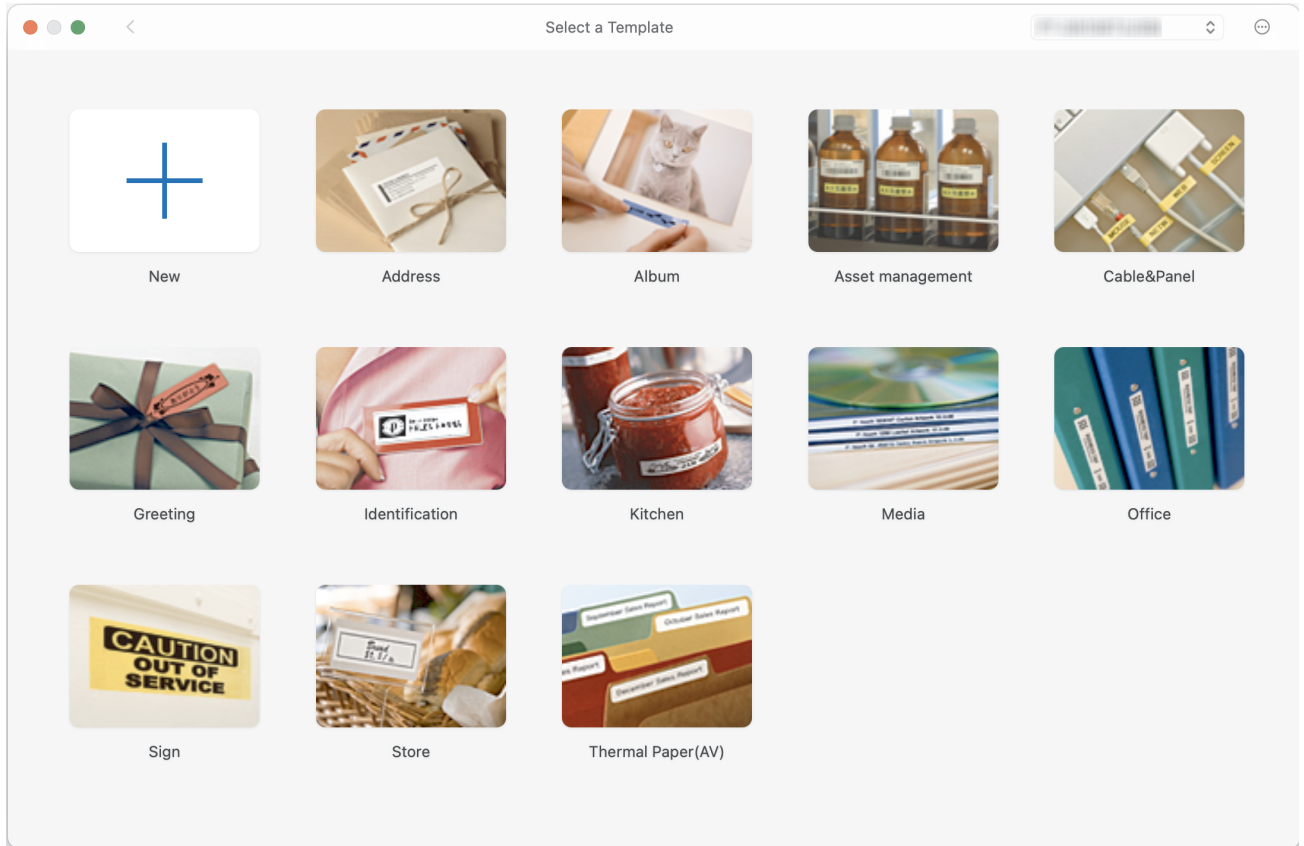

3. Select the print settings.
4. Click the **Print** icon.

✓ Related Information

- [Create and Print Labels Using Your Computer](#)
 - [Main Window of P-touch Editor \(Mac\)](#)

Main Window of P-touch Editor (Mac)

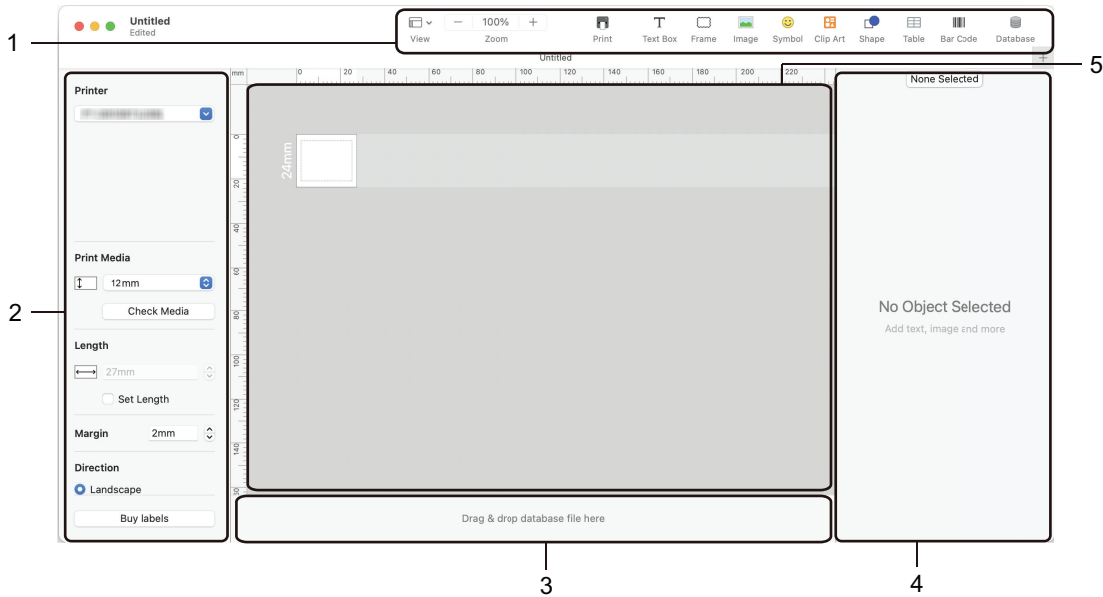

1. Toolbar
2. Object Inspector
3. Database Connection Area
4. Label Inspector
5. Layout Window

✓ Related Information

- [Create Labels and Print Using P-touch Editor \(Mac\)](#)

Print Labels Using the Printer Driver (Windows)

Make sure you have installed the printer driver.

For the latest drivers and software, go to your model's **Downloads** page on the Brother support website at support.brother.com.

1. Connect the Label Printer to a computer.
2. Open the document you want to print.
3. Select the print command in your application.
4. Select your Label Printer, and then click the printer's properties or preferences button.
The printer driver window appears.
5. Change the printer driver settings, if needed.
6. Click **OK**.
7. Complete your print operation.



Related Information

- [Create and Print Labels Using Your Computer](#)

Related Topics:

- [Connect the Label Printer to a Computer Using a USB Cable](#)
- [Enable or Disable Bluetooth](#)
- [Install the Printer Driver and Software on a Computer \(Windows\)](#)

Print Labels Using Mobile Devices

Related Models: PT-D460BT

- [Install the Brother iPrint&Label App](#)
- [Create Labels and Print Using Mobile Devices](#)

Install the Brother iPrint&Label App

Related Models: PT-D460BT

Use Brother's iPrint&Label app to print directly from your iPhone, iPad, iPod touch, and Android™ mobile devices.

App	Features
Brother iPrint&Label	Create labels for business use, including barcodes, office equipment labels, and labels for folder tabs.

For more information about the mobile apps available for your printer, visit <https://support.brother.com/g/d/f5f9>.



Related Information

- [Print Labels Using Mobile Devices](#)

Create Labels and Print Using Mobile Devices

Related Models: PT-D460BT

Make sure the Label Printer is connected to your mobile device via Bluetooth or using a USB cable.

1. Start the label printing app on your mobile device.
2. Select a label template or design.



You can also select a previously designed label or image and print it.

3. Select the print menu in the label printing app.



Related Information

- [Print Labels Using Mobile Devices](#)

Routine Maintenance

- [Maintenance](#)

Maintenance

Always remove the batteries and disconnect the AC Adapter before cleaning the Label Printer.

- >> [Clean the Unit](#)
- >> [Clean the Print Head](#)
- >> [Clean the Tape Cutter](#)

Clean the Unit

1. Wipe any dust and marks from the Label Printer using a soft, dry cloth.
2. Use a slightly dampened cloth on difficult to remove marks.



Do not use paint thinner, benzene, alcohol or any other organic solvent. These may deform or damage the case of your Label Printer.

Clean the Print Head

Streaks or poor quality characters on printed labels generally indicate that the Print Head is dirty. Clean the Print Head using a cotton swab or the optional Print Head Cleaning Cassette (TZe-CL4).

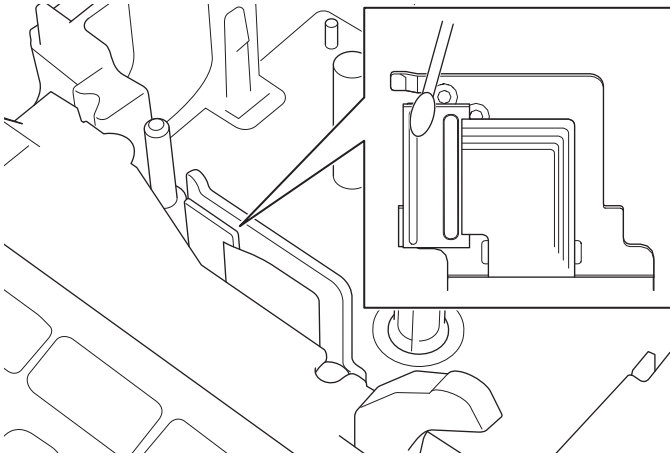

- Do not touch the Print Head directly with your bare hands.
- Read and follow the instructions provided with the Print Head Cleaning Cassette.

Clean the Tape Cutter

Tape adhesive can build up on the cutter blade after repeated use, taking the edge off the blade, which may result in the tape jamming in the cutter.

About once a year, wipe the cutter blade using a cotton swab moistened with Isopropyl alcohol (rubbing alcohol).

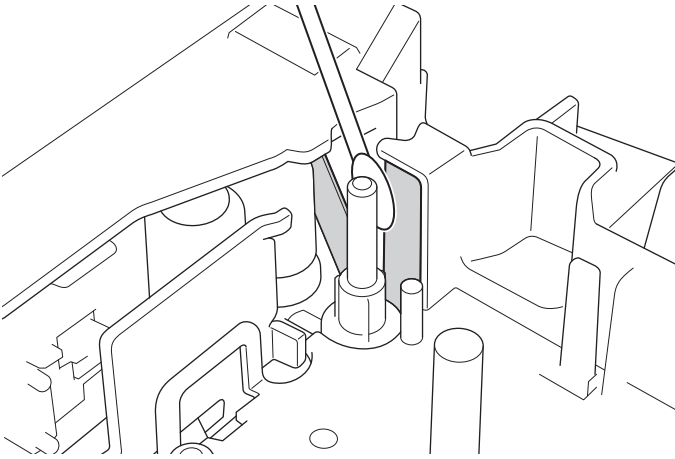

- Do not touch the cutter blade directly with your bare hands.
 - Use isopropyl alcohol according to the manufacturer's guidelines.
-



Related Information

- [Routine Maintenance](#)
-

Troubleshooting



- [If You Are Having Difficulty with Your Label Printer](#)
- [Error and Maintenance Messages](#)
- [Check the Version Information](#)
- [Reset the Label Printer](#)

If You Are Having Difficulty with Your Label Printer

This chapter explains how to resolve typical problems you may encounter when using the Label Printer.

If you still have problems, see *Related Information*. If after reading the topics you are unable to resolve the problem, visit the Brother support website at support.brother.com.

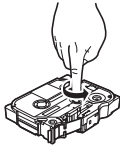
Problem	Solution
The Label Printer does not print.	<ul style="list-style-type: none"> • Check that the Tape Cassette is inserted correctly. • If the Tape Cassette is empty, replace it. To order supplies and accessories, visit www.brother.com. • Check that the Tape Cassette Compartment Cover is securely closed. • Check that the Label Printer is on. • (PT-D460BT) Check that the computer's or mobile device's Bluetooth setting is on. • (PT-D460BT) Check that the Label Printer is connected to the computer or your mobile device via Bluetooth. • Check that the Label Printer is selected in the Brother iPrint&Label app. • Check that the Label Printer is not paired with another device. • Make sure the Label Printer and your mobile device or computer are close enough to communicate. • (PT-D460BT) Check that the automatic Bluetooth reconnection setting of another computer or mobile device is not enabled. • Make sure no devices that emit radio waves (for example, a microwave oven) are located nearby. • Check that the correct printer driver is installed when printing from a computer. • Connect the Label Printer to your computer using the USB Cable (included) when printing from a computer. • If the Print Head is dirty, clean it with a cotton swab or optional Print Head Cleaning Cassette (TZe-CL4).
<ul style="list-style-type: none"> • The tape does not feed correctly. • The tape gets stuck inside the Label Printer. 	<ul style="list-style-type: none"> • If the tape is bent, cut off the bent section. • If the tape is jammed, remove the Tape Cassette, remove the jammed tape, and then cut off any damaged tape. • Check that the end of the tape exits through the Tape Guide. • Confirm that the tape is pointed at the Tape Exit Slot. • Remove the Tape Cassette and insert it again.
An error occurred when using a mobile app.	Go to your mobile application's settings menu and select Support > FAQs & Troubleshooting .
The screen has locked.	<ul style="list-style-type: none"> • Reset the internal memory to the factory settings. For more information, see <i>Related Topics</i>. • Disconnect the AC Adapter and remove the batteries for at least 10 minutes.
The LCD remains blank after turning the power on.	Check that the batteries are correctly installed or that the AC Adapter included with your Label Printer is correctly connected.
The LCD messages are displayed in a foreign language.	Set the LCD language you want. For more information, see <i>Related Topics</i> .
The Label Printer stops while printing a label.	<ul style="list-style-type: none"> • Replace the Tape Cassette if striped tape is visible, as this indicates that you have reached the end of the tape. • Replace all batteries or connect the AC Adapter directly to the Label Printer.
Previously saved label files are not available.	All files saved in the internal memory are deleted when the batteries are weak or the AC Adapter is disconnected.
<ul style="list-style-type: none"> • I cannot install the Printer Driver even if I 	<p>If you cannot use your Label Printer even though you have installed the Printer Driver:</p> <ol style="list-style-type: none"> 1. Download the Printer Driver Uninstaller from your model's page at support.brother.com.

Problem	Solution
<p>follow the correct procedure. (Windows)</p> <ul style="list-style-type: none"> I cannot see my printer listed in P-touch Editor even though I have installed the Printer Driver. (Windows) 	<ol style="list-style-type: none"> Use the Printer Driver Uninstaller to remove the printer information. Run the Printer Driver Installer again and follow the on-screen instructions to proceed with the installation.
<p>The ink ribbon is separated from the ink roller.</p>	<p>If the ink ribbon is damaged, replace the Tape Cassette. If it is not, leave the tape uncut and carefully remove the Tape Cassette, and then wind the loose ink ribbon back onto the spool.</p> 
<p>Printed barcodes or QR codes cannot be read.</p>	<ul style="list-style-type: none"> Change the tape. (Recommended: Black on white tape) Enlarge the barcodes or QR codes using your barcode application, if possible.
<p>I do not know the version number of the firmware for the Label Printer.</p>	<p>You can confirm the firmware version number and other information on the LCD. For more information, see <i>Related Topics</i>.</p>
<p>When the label is printed, there is too much margin (space) on both sides of the text.</p>	<ul style="list-style-type: none"> Select Small Margin, Chain, or No Cut options for smaller margins. For more information, see <i>Related Topics</i>. After the last label prints, press  and  simultaneously to feed the tape, and then eject and cut the last label. Note that the Label Printer will feed approximately 23 mm of tape before the next new label when you use this method.
<p>The font size cannot be increased.</p>	<p>The font is already the maximum size for the width of the label, or the label length has been set, so there is a limit on the font size to prevent exceeding the set length.</p>
<p>When multiple labels are printed, the last label is cut incorrectly.</p>	<p>When Chain is enabled, feed the tape to eject the last printed label, and then press the Tape Cutter Lever to cut the label manually.</p>
<p>I cannot update the printer's firmware using the P-touch Update Software, Transfer Update Software, Mac Update Express, or Mac Update Tool.</p>	<p>Restart the printer and then try to update the firmware again. Do not press any buttons during the firmware update until the Home Screen is displayed automatically.</p>
<p>The Label Printer does not operate normally.</p>	<ul style="list-style-type: none"> Reset the internal memory to the factory settings. For more information, see <i>Related Topics</i>. Disconnect the AC Adapter and remove the batteries for at least 10 minutes.

Related Information

- [Troubleshooting](#)

Related Topics:

- [Reset the Label Printer](#)
- [Set Language](#)
- [Check the Version Information](#)
- [Tape Cutting Options](#)

Error and Maintenance Messages

>> [PT-D410](#)

>> [PT-D460BT](#)

PT-D410

Message	Cause/Remedy
Check no. of digits entered	The number of digits entered in the barcode data does not match the number of digits set in the barcode parameters. Enter the correct number of digits.
Cutter error	The Tape Cutter Lever was pressed while trying to print or feed the tape. If the tape is jammed in the Cutter unit, remove the tape. Turn the Label Printer off and then on again before continuing.
Length limit	The printed label length using the text entered is longer than 999 mm. Edit the text so that the label length is less than 999 mm.
System error XX	Contact Brother customer service.
Text too long	The printed label length using the text entered is longer than the length setting. Edit the text to fit within the set length or change the length setting.

PT-D460BT

Message	Cause/Remedy
Check no. of digits entered	The number of digits entered in the barcode data does not match the number of digits set in the barcode parameters. Enter the correct number of digits.
Cutter malfunction	If the tape is jammed in the Cutter unit, remove the tape. Turn the Label Printer off and then on again before continuing.
Label too long	The printed label length using the text entered is longer than 999 mm. Edit the text so that the label length is less than 999 mm.
System error XX	Contact Brother customer service.
Text too long	The printed label length using the text entered is longer than the length setting. Edit the text to fit within the set length or change the length setting.



Related Information

- [Troubleshooting](#)

Check the Version Information

You can confirm the firmware version number and other information on the LCD. You may need this information if you call Brother regarding a question or a warranty.

>> [PT-D410](#)

>> [PT-D460BT](#)

PT-D410

1. Press .
2. Press **▲** or **▼** to display [Version Information], and then press **OK**.

PT-D460BT

1. Press .
2. Press **◀** or **▶** to display [Settings], and then press **OK**.
3. Press **▲** or **▼** to display [Version Information], and then press **OK**.



Related Information

- [Troubleshooting](#)

Reset the Label Printer

Reset the internal memory of your Label Printer to clear all saved label files, or if the Label Printer is not operating correctly.







- [Reset the Printer to the Factory Settings](#)
- [Reset Using the LCD](#)

Reset the Printer to the Factory Settings

Related Models: PT-D410

NOTE

All text, format settings, option settings and saved label files are cleared when you reset the Label Printer. Language and measurement unit settings are also cleared.

1. Turn the Label Printer off.
2. Press and hold  and .
3. While holding  and , press  once and then release  and .

NOTE

Release  before releasing the other keys.

✓ Related Information

- [Reset the Label Printer](#)

Reset Using the LCD

Related Models: PT-D460BT

1. Press .
2. Press ◀ or ▶ to display [Settings], and then press **OK**.
3. Press ▲ or ▼ to display [Reset], and then press **OK**.
4. Press ▲ or ▼ to display the reset method, and then press **OK**.
A message appears asking you to confirm your reset option.
5. Press **OK**.



If using the [Reset All Settings] or [Factory Settings] reset options, you will need to set your preferred default language again after the reset.

Reset Options	Details
Reset All Settings	File memory is NOT cleared. Settings data is cleared and all settings are reset to the factory settings.
Erase All Content	File memory is cleared. Settings data is NOT cleared and settings remain as currently configured.
Factory Settings	File memory, labels, and customised settings are reset to the factory settings.



Related Information

- [Reset the Label Printer](#)

Appendix

- [Specifications](#)
- [Brother Help and Customer Support](#)

Specifications

- >> [Printing](#)
- >> [Size](#)
- >> [Interface](#)
- >> [Environment](#)
- >> [Power Supply](#)
- >> [Media](#)
- >> [Memory](#)
- >> [Compatible Operating Systems](#)

Printing

Print Speed (Depending on the media used)	Maximum 20 mm/s (PT-D410) Maximum 30 mm/s (PT-D460BT)
Maximum Print Height	15.8 mm (when using 18 mm tape) ¹

¹ The actual character size may be smaller than the maximum print height.

Size

Weight	Approximately 760 g (without batteries and Tape Cassette) (PT-D410) Approximately 770 g (without batteries and Tape Cassette) (PT-D460BT)
Dimensions	Approximately 187 mm (W) x 178 mm (D) x 72 mm (H) (PT-D410) Approximately 187 mm (W) x 178 mm (D) x 72 mm (H) (PT-D460BT)
LCD	128 dot x 48 dot (PT-D410) 320 dot x 120 dot (PT-D460BT)

Interface

USB	USB Ver.2.0 (Full Speed) (Micro B)
Bluetooth (PT-D460BT)	Bluetooth Ver.5.0 SPP: iAP2

Environment

Operating Temperature	Between 10°C and 35°C
Operating Humidity	Between 20% and 80% Maximum wet bulb temperature: 27°C

Power Supply

Battery	Six AA alkaline batteries (LR6) AC Adapter (AD-E001A)
----------------	--

Media

Tape Width	Standard TZe Tape Cassette: 3.5 mm, 6 mm, 9 mm, 12 mm, 18 mm
No. of Lines	18 mm tape: 1 - 5 lines 12 mm tape: 1 - 3 lines 9 mm tape: 1 - 2 lines

	6 mm tape: 1 - 2 lines 3.5 mm tape: 1 line
--	---

Memory

Text Buffer	Maximum 280 characters
File Storage	Maximum 50 files (PT-D410) Maximum 70 files (PT-D460BT)

Compatible Operating Systems

For the latest list of compatible software, visit support.brother.com.

Related Information

- [Appendix](#)
-

Brother Help and Customer Support

If you need help with using your Brother product, visit support.brother.com for FAQs and troubleshooting tips. You can also download the latest software, drivers and firmware, to improve the performance of your machine, and user documentation, to learn how to get the most from your Brother product.

Further product and support information is available from your local Brother office website. Visit www.brother.com to find the contact details for your local Brother office and to register your new product.



Related Information

- [Appendix](#)
-

brother



UK
Version 0