



Online User's Guide

DSmobile DS-640

DSmobile DS-740D

DSmobile DS-940DW

Table of Contents

Before You Use Your Brother Machine	1
Definitions of Notes	2
Trademarks	3
Important Note	4
Introduction to Your Brother Machine	5
About This Machine	6
Control Panel Overview	9
Charge the Battery	13
Paper Handling	14
Document Specifications	15
Acceptable Documents	16
Unacceptable Documents	18
Carrier Sheet Recommendations	19
Notes for Using Carrier Sheets	20
Load Documents	21
Load Standard Size Document	22
Load a Plastic Card	23
Load Non-standard Size Document	24
Use the Output Guide.....	26
Scan	28
Before Scanning.....	29
Scan Using the Scan Functions on Your Brother Machine	30
Save Scanned Documents on Your Computer	31
Save Scanned Documents to a Memory Card	32
Web Services for Scanning on Your Network (Windows 7, Windows 8.1 and Windows 10)	34
Restrict Scan Functions from External Devices	37
Scan from Your Computer (Windows)	38
Scan Using Nuance™ PaperPort™ 14SE or Other Windows Applications.....	39
Scan Using Windows Photo Gallery or Windows Fax and Scan.....	45
Scan Using Kofax Power PDF Standard v3	49
Scan Using Brother iPrint&Scan (Windows)	50
Scan from Your Computer (Mac).....	51
Scan Using Brother iPrint&Scan (Mac)	52
Scan Using Apple Image Capture (ICA Driver)	53
Using AirPrint Scanning	57
Scan Using Brother iPrint&Scan for Mobile	60
Brother iPrint&Scan for Mobile Devices	61
Scan Using Presto! BizCard.....	62
Network	63
Supported Basic Network Features	64
Network Management Software and Utilities	65
Learn about Network Management Software and Utilities	66
Additional Methods of Configuring Your Brother Machine for a Wireless Network	67
Before Configuring Your Brother Machine for a Wireless Network.....	68



Configure Your Machine for a Wireless Network Using the One-Push Method of Wi-Fi Protected Setup™ (WPS).....	69
Configure Your Machine for a Wireless Network Using the PIN Method of Wi-Fi Protected Setup™ (WPS).....	70
Use Wireless Direct.....	72
Use Infrastructure Mode.....	75
Advanced Network Features.....	79
Synchronise Time with the SNTP Server Using Web Based Management	80
Security	85
Network Security Features.....	86
Manage Your Network Machine Securely Using SSL/TLS.....	87
Brother iPrint&Scan for Windows and Mac.....	98
Brother iPrint&Scan Overview.....	99
Troubleshooting	100
Error and Maintenance Indications	101
Service Call Indications	104
Document Jam	105
If You Are Having Difficulty with Your Machine	107
Scanning and Other Problems	108
AirPrint Scanning Problems	114
Network Problems	115
Check the Serial Number	123
Reset Your Brother Machine	124
Routine Maintenance	126
Clean Your Brother Machine	127
Clean the Outside of the Machine	128
Clean the Scanner and Rollers	129
Calibrate Your Brother Machine	131
Supplies	133
Pack and Ship Your Brother Machine	134
Remove and Dispose the Battery	135
Machine Settings.....	137
Change Machine Settings from Your Computer.....	138
Change Machine Settings Using Web Based Management	139
Change the Machine Settings Using Remote Setup	143
Appendix.....	152
Specifications	153
Brother Help and Customer Support.....	158

Before You Use Your Brother Machine

- [Definitions of Notes](#)
- [Trademarks](#)
- [Important Note](#)

Definitions of Notes

We use the following symbols and conventions throughout this User's Guide:

 CAUTION	CAUTION indicates a potentially hazardous situation which, if not avoided, may result in minor or moderate injuries.
IMPORTANT	IMPORTANT indicates a potentially hazardous situation which, if not avoided, may result in damage to property or loss of product functionality.
NOTE	NOTE specifies the operating environment, conditions for installation, or special conditions of use.
	Tips icons indicate helpful hints and supplementary information.
Bold	Bold style identifies buttons on the machine's control panel or computer screen.
<i>Italics</i>	Italicised style emphasises an important point or refers you to a related topic.



Related Information

- [Before You Use Your Brother Machine](#)

Trademarks

Brother is either a trademark or a registered trademark of Brother Industries, Ltd.

Microsoft, Windows, Windows Server, Internet Explorer, Word, Excel, PowerPoint and Microsoft Edge are either registered trademarks or trademarks of Microsoft Corporation in the United States and/or other countries.

Apple, AirPrint, App Store, Mac, Safari, iPad, iPhone, iPod touch and macOS are trademarks of Apple Inc., registered in the United States and other countries.

Kofax, PaperPort and Power PDF, are trademarks or registered trademarks of Kofax in the U.S. and/or other countries. All other trademarks are the trademarks or registered trademarks of their respective owners.

Wi-Fi® and Wi-Fi Alliance® are registered trademarks of Wi-Fi Alliance®.

WPA™, WPA2™, Wi-Fi Protected Setup™ and Wi-Fi Protected Setup™ logo are trademarks of Wi-Fi Alliance®.

Android and Google Play are trademarks of Google LLC.

microSD Logo is a trademark of SD-3C LLC.

The Bluetooth® word mark is a registered trademark owned by the Bluetooth SIG, Inc. and any use of such marks by Brother Industries, Ltd. and related companies is under license. Other trademarks and trade names are those of their respective owners.

Each company whose software title is mentioned in this manual has a Software License Agreement specific to its proprietary programs.

Any trade names and product names of companies appearing on Brother products, related documents and any other materials are all trademarks or registered trademarks of those respective companies.



Related Information

- [Before You Use Your Brother Machine](#)

Important Note

- The latest manuals are available at support.brother.com/manuals.
- Check support.brother.com for Brother driver and software updates.
- To keep your machine performance up to date, check support.brother.com for the latest firmware upgrade. Otherwise, some of your machine's functions may not be available.
- Do not use this product outside the country of purchase as it may violate the wireless telecommunication and power regulations of that country.
- Not all models are available in all countries.
- In this *User's Guide*, illustrations of the DSmobile DS-940DW are used, unless otherwise specified.
- The screens in this *User's Guide* are for illustration purposes only and may differ from the actual screens.
- Unless otherwise specified, the screens in this manual are from Windows 10 and macOS v10.12.x. Screens on your computer may vary depending on your operating system.
- The contents of this guide and the specifications of this product are subject to change without notice.



Related Information

- [Before You Use Your Brother Machine](#)
-

Introduction to Your Brother Machine

- [About This Machine](#)
- [Control Panel Overview](#)
- [Charge the Battery](#)

About This Machine

- >> DSmobile DS-640
- >> DSmobile DS-740D
- >> DSmobile DS-940DW

DSmobile DS-640

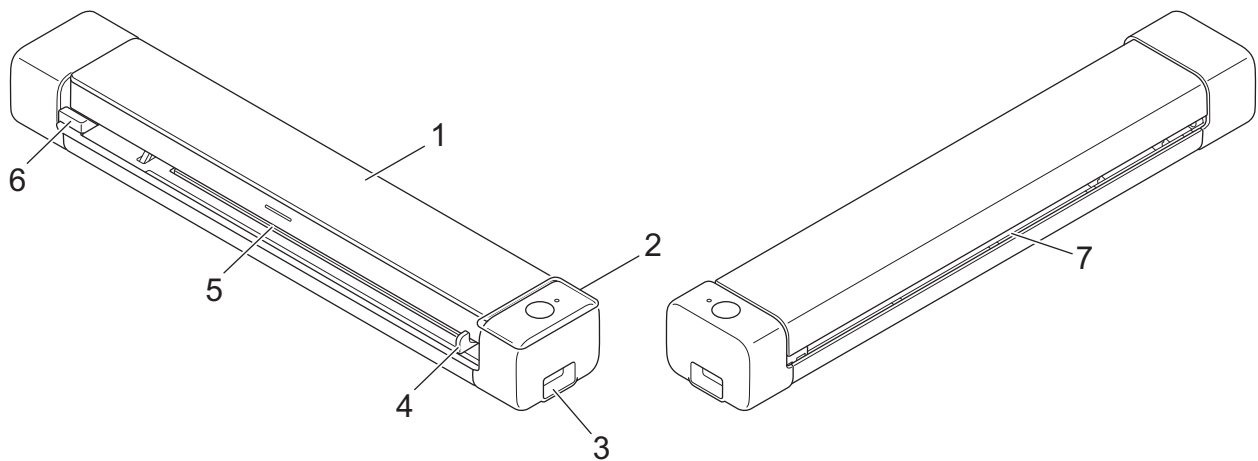

1. Top Cover
2. Control Panel
3. Micro USB 3.0 Port (for connecting to a computer)
4. Document Guide
5. Feeder Slot
6. Left Edge of the Feeder Slot
7. Paper Output Slot

DSmobile DS-740D

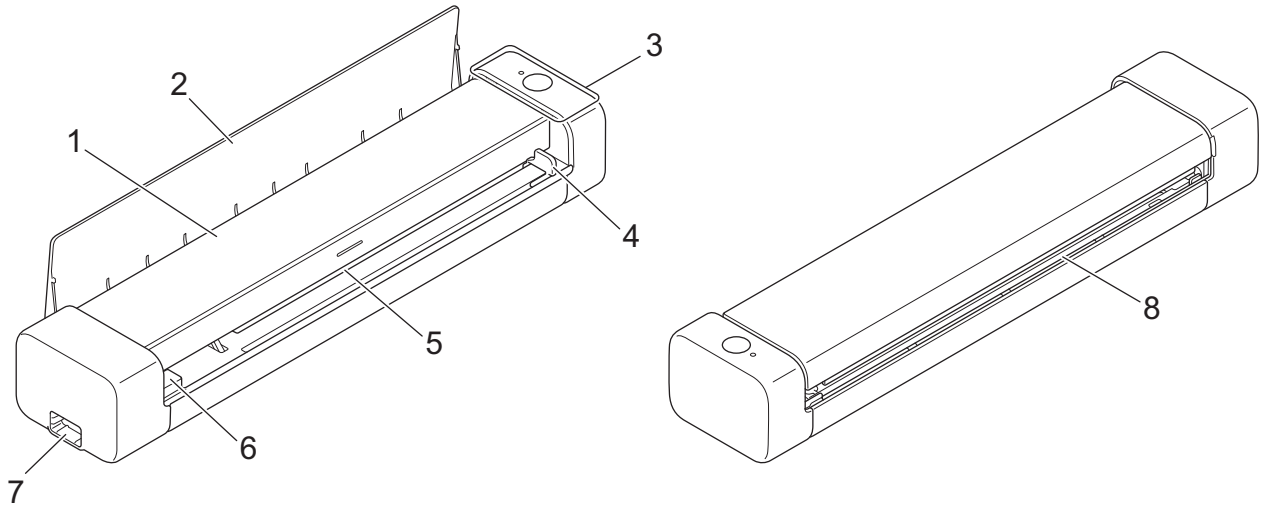

1. Top Cover
2. Output Guide
3. Control Panel
4. Document Guide
5. Feeder Slot
6. Left Edge of the Feeder Slot
7. Micro USB 3.0 Port (for connecting to a computer)
8. Paper Output Slot

DSmobile DS-940DW

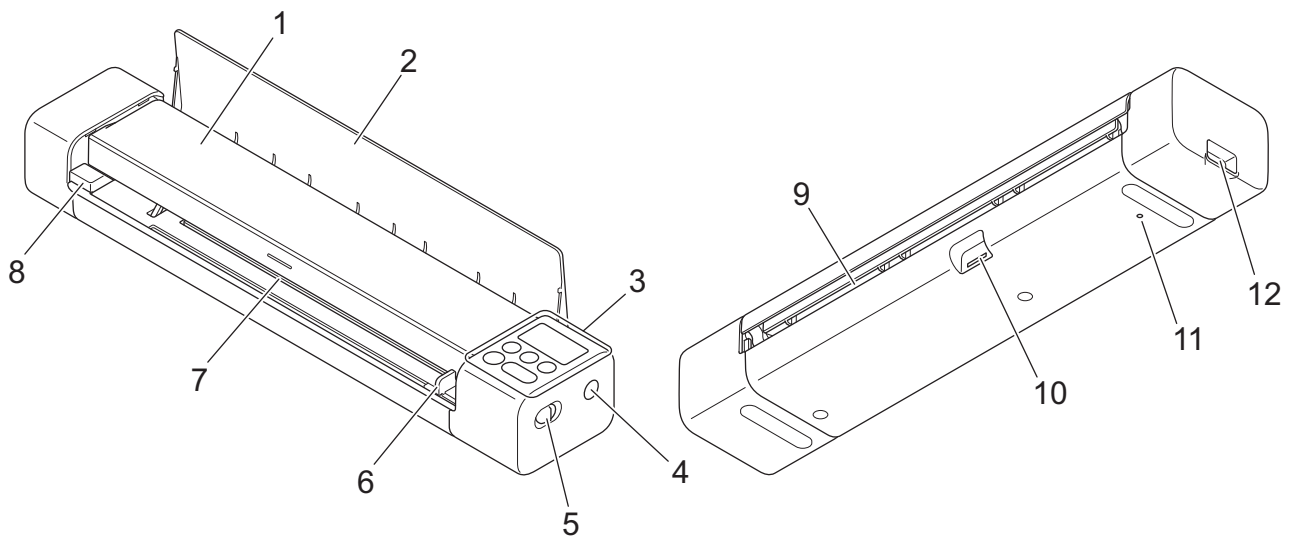

1. Top Cover
2. Output Guide

3. Control Panel

4. WPS Button

5. Mode Select Switch

- microSD Mode 
- USB Mode 
- Wi-Fi Mode 

6. Document Guide

7. Feeder Slot

8. Left Edge of the Feeder Slot

9. Paper Output Slot

10. Memory Card Slot

11. Reboot Button

12. Micro USB 3.0 Port (for connecting to a computer)



Related Information

- [Introduction to Your Brother Machine](#)

Control Panel Overview



- >> [DSmobile DS-640/DSmobile DS-740D](#)
- >> [DSmobile DS-940DW](#)

DSmobile DS-640/DSmobile DS-740D



1. Power/Scan LED

Indicates the machine's status.

	The machine is in Ready Mode.
 (blinking)	<ul style="list-style-type: none">• The machine is scanning.• Remote Setup is in progress.• The machine is starting up.
 (blinking)	An error has occurred.

2. START/STOP Button

Press to start or stop scanning.

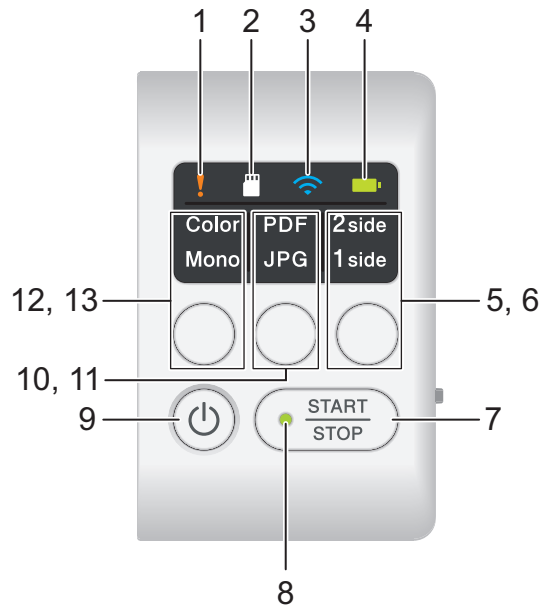





1. Error LED

Blinks when the machine detects an error.

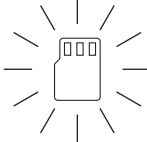

2. SD Card LED

Indicates the microSD memory card status when the machine is in microSD Mode.

	<p>microSD memory card is inserted.</p> 
 (blinking)	<p>microSD memory card is not inserted.</p>
	<p>The machine is not in microSD Mode.</p>

3. Wi-Fi LED

Indicates the wireless network status when the machine is in Wi-Fi Mode.

	<p>Wireless network is connected.</p>
 (blinking)	<p>Your machine is connecting to the wireless network.</p>
 (blinking slowly)	<p>Wi-Fi settings are not configured.</p>









The machine is not in Wi-Fi Mode.



4. Battery LED

Indicates the rechargeable Li-ion battery status.

- When the machine is connected to the computer using a USB cable

 (When the machine is turned on.)  (When the machine is turned off.)	Battery is fully charged.
 (blinking)	The machine is charging the battery.
 (blinking)	Battery Low. The machine is charging the battery.
  	A battery error has occurred.

- When the machine is not connected to the computer using a USB cable (The battery does not charge)

	The machine is turned on and the battery power is consumed.
	Battery Low. The machine is turned on and the battery power is consumed.
	The machine is turned off or the battery has no remaining power.

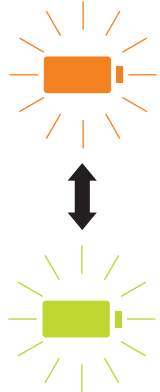
	<p>A battery error has occurred.</p>
---	--------------------------------------

5. 2side/1side LED

Indicates the scan option selected in microSD Mode.

6. 2side/1side Switching Button



Press to change the scan mode (2-sided Scan or single-sided Scan) in microSD Mode.

7. START/STOP Button



Press to start or stop scanning.

8. Power/Scan LED

Indicates the machine's status.

	<p>The machine is in Ready Mode.</p>
 (blinking)	<ul style="list-style-type: none"> • The machine is scanning. • Remote Setup is in progress. • The machine is preparing to charge the battery. • The machine is starting up. • The machine is shutting down.

9. Power Button

Press  to turn the machine on. Press and hold  to turn the machine off.



If the machine is connected to the computer using a USB cable and the battery is not fully charged, the machine turns off and goes into Battery Charge Mode when you press and hold . (The Battery LED blinks.)

The machine turns off after the battery is fully charged or when the USB cable is disconnected from the machine or computer.

10. PDF/JPEG LED

Indicates the scan option selected in microSD Mode.

11. PDF/JPEG Switching Button

Press to change the scanning file format (PDF or JPEG) in microSD Mode.

12. Color/Mono LED

Indicates the scan option selected in microSD Mode.

13. Colour/Mono Switching Button

Press to change the scan mode (colour or monochrome) in microSD Mode.



Related Information

- [Introduction to Your Brother Machine](#)

Charge the Battery

Related Models: DSmobile DS-940DW

The scanner charges the rechargeable Li-ion battery when it is powered on, but will charge the battery faster when the scanner powered off.

1. Make sure that your computer is on.
2. Connect the USB cable to your scanner's USB port.
3. Connect the USB cable to your computer.

The battery starts charging automatically.

The Battery LED blinks in green or orange while the battery is charging, and turns off or lights in green when charging is complete.



- Charging stops if the temperature is higher than the recommended operating temperature. For more information, see *Related Information: Specifications*.
- If you do not use the scanner for a long period, fully charge the battery at least once every three months to prolong the battery life.
- If you do not use the scanner for a long period, store it in a cool, dry place at a consistent temperature.



Related Information

- [Introduction to Your Brother Machine](#)

Related Topics:

- [Specifications](#)

Paper Handling

- [Document Specifications](#)
- [Load Documents](#)

Document Specifications

- [Acceptable Documents](#)
- [Unacceptable Documents](#)
- [Carrier Sheet Recommendations](#)
- [Notes for Using Carrier Sheets](#)

Acceptable Documents

Standard Paper

Size	DSmobile DS-640: <ul style="list-style-type: none"> 86.4 mm x 50.8 mm to 1828.8 mm x 215.9 mm DSmobile DS-740D/DSmobile DS-940DW: <ul style="list-style-type: none"> Single-sided Scan 86.4 mm x 50.8 mm to 1828.8 mm x 215.9 mm 2-sided Scan 86.4 mm x 50.8 mm to 406.48 mm x 215.9 mm Output Guide 105 mm x 74 mm to 297 mm x 215.9 mm 	
Weight	35 g/m ² to 270 g/m ² Output Guide (DSmobile DS-740D/DSmobile DS-940DW): 52 g/m ² to 80 g/m ²	
Thickness	0.04 mm to 0.28 mm To scan thinner documents, use the Carrier Sheet (not included).	
Maximum Number of Pages	1 page (1 sheet)	
Standard Paper Size	A4	210 mm x 297 mm
	A5	148 mm x 210 mm
	A6	105 mm x 148 mm
	B5	182 mm x 257 mm
	B6	128 mm x 182 mm
	Legal	215.9 mm x 355.6 mm
	Mexican Legal	215.9 mm x 339.9 mm
	India Legal	215 mm x 345 mm
	Letter	215.9 mm x 279.4 mm
	Executive	184.1 mm x 266.7 mm
	Folio	215.9 mm x 330.2 mm
	Index Card	13 cm x 20 cm
	Business Card	90 mm x 60 mm

Non-standard Size Paper

Photo	10 cm x 15 cm
Photo L	9 cm x 13 cm
Photo 2L	13 cm x 18 cm

Plastic Card

Size (ISO)	85.6 mm x 53.98 mm
Material	Plastic (PET)
Type	Plastic card such as a store card.
Thickness	Up to 1.24 mm (with embossing) Up to 1 mm (without embossing)
Maximum Number of Cards	One card



Certain types of embossed cards may not scan correctly.



Related Information

- [Document Specifications](#)

Related Topics:

- [Supplies](#)
-

Unacceptable Documents

The following types of documents may not be scanned successfully:

- Documents with paper clips or staples
- Documents with wet ink
- Fabrics, metallic sheets, or overhead projector sheets
- Glossy or mirrored media
- Documents that exceed recommended thicknesses

IMPORTANT

The damage caused by using any unacceptable documents with your Brother machine may not be covered under warranty.



Related Information

- [Document Specifications](#)
-

Carrier Sheet Recommendations

Brother recommends using a Carrier Sheet (not included) to scan the following documents:

- Documents with a carbon sheet attached
- Documents written in pencil
- Documents narrower than 50.8 mm
- Documents shorter than 86.4 mm
- Pages thinner than 0.04 mm
- Documents of uneven thickness, such as envelopes
- Documents with large wrinkles or curls
- Bent or damaged documents
- Documents that use tracing paper
- Documents that use coated paper
- Photographs (photographic paper)
- Documents printed on perforated paper
- Documents printed on unusually-shaped paper (not square or rectangle)
- Documents with photos, notes, or stickers attached to them
- Documents that use carbonless paper
- Documents that use loose-leaf paper or any paper with holes in it

CAUTION

To avoid cutting yourself, do not slide or scrape your hand or fingers along the edge of the Carrier Sheet.

IMPORTANT

- To avoid warping the Carrier Sheet, do not place the Carrier Sheet in direct sunlight or in an area subject to high temperatures and high humidity.
- To avoid damaging the Carrier Sheet, do not bend or pull it. Do not use a damaged Carrier Sheet, as it may produce incorrect scan results.

Related Information

- [Document Specifications](#)

Related Topics:

- [Supplies](#)

Notes for Using Carrier Sheets

- To avoid document jams, do not load the Carrier Sheet (not included) upside down. See the instructions printed on the Carrier Sheet itself for more information.
- To avoid document jams, do not put several small documents into the Carrier Sheet at the same time. Insert only one document into the Carrier Sheet at a time.
- Do not write on the Carrier Sheet, as the writing may be seen in scanned documents. If the Carrier Sheet becomes dirty, wipe it with a dry cloth.
- Do not leave documents in the Carrier Sheet for extended periods of time; the printing on the documents may bleed through onto the Carrier Sheet.
- **If you use any of the Unacceptable Documents and damage your Brother machine, it may not be covered under warranty.**



Related Information

- [Document Specifications](#)

Related Topics:

- [Supplies](#)

Load Documents

IMPORTANT

- Insert only one page into the scanner at a time. Insert the next page only after the first one is completely scanned. Inserting more than one page at a time may cause your scanner to malfunction.
- Make sure documents with ink or correction fluid are completely dry.
- DO NOT pull on the document while it is feeding.
- DO NOT use paper that is curled, wrinkled, folded, ripped, stapled, paper-clipped, pasted, or taped.
- DO NOT use cardboard or fabric.



- Make sure there is enough space behind the Paper Output Slot. The scanned document is ejected from the rear of the scanner.
 - (DSmobile DS-740D/DSmobile DS-940DW) To eject the paper from the top of the scanner, open the Output Guide.
-
- [Load Standard Size Document](#)
 - [Load a Plastic Card](#)
 - [Load Non-standard Size Document](#)
 - [Use the Output Guide](#)

Load Standard Size Document

(DSmobile DS-740D/DSmobile DS-940DW) If you scan the index card or business card, confirm the Output Guide is closed.

1. Set your document *face up* in the Feeder Slot and align the left edge of the page with the Left Edge of the Feeder Slot.



 (DSmobile DS-740D/DSmobile DS-940DW) When you perform 2-sided scanning, insert the first page face up into the Feeder Slot.

2. Slide the Document Guide until it touches the right side of the document.

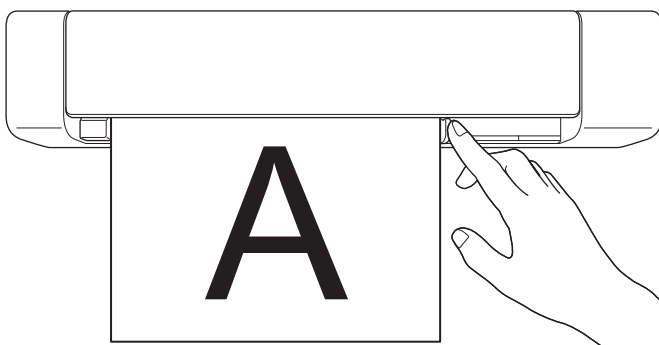

3. Gently insert the document until you feel its top edge touch the inside of the scanner.
(DSmobile DS-940DW) When the machine is in microSD Mode, scanning begins automatically.

Related Information

- [Load Documents](#)

Load a Plastic Card

- Load only one plastic card at a time.
 - Load the plastic card long edge first.
 - Certain types of plastic cards may be scratched when scanned. To prevent damage to the card, we recommended using the Carrier Sheet.
 - If the surface of the card is dirty with grease marks (for example, fingerprints) or similar, wipe the dirt off before scanning.
 - Certain types of embossed cards may not scan correctly.
 - (DSmobile DS-740D/DSmobile DS-940DW) Confirm the Output Guide is closed.
1. Set the card top edge first into the Feeder Slot and align the left edge of the card with the Left Edge of the Feeder Slot.

NOTE

If you insert an embossed card, make sure to insert it embossed side up into the Feeder Slot.

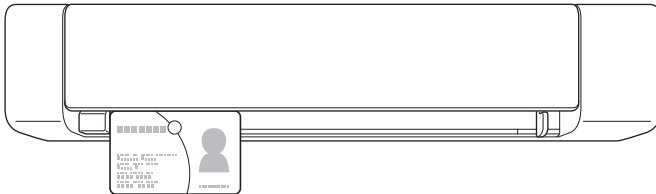

2. Slide the Document Guide until it touches the right side of the card.

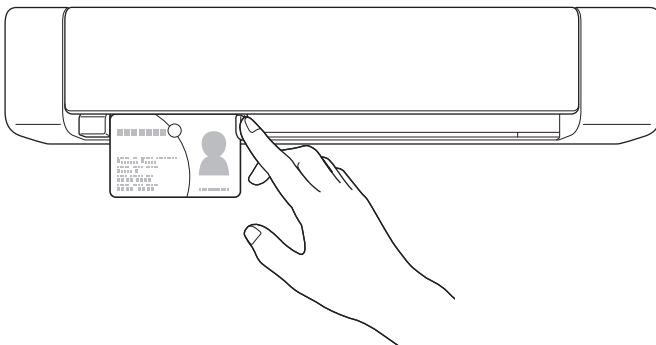

3. Gently insert the card until you feel its top edge touch the inside of the scanner.
(DSmobile DS-940DW) When the machine is in microSD Mode, scanning begins automatically.



Related Information

- [Load Documents](#)

Load Non-standard Size Document

- Make sure documents with ink or correction fluid are completely dry.
- Non-standard documents can include receipts, newspaper clippings, and photos.
- (DSmobile DS-740D/DSmobile DS-940DW) Confirm the Output Guide is closed.

1. Set the document you want to scan in the left corner of the Carrier Sheet and align the top of the document with the top left corner of the Carrier Sheet.

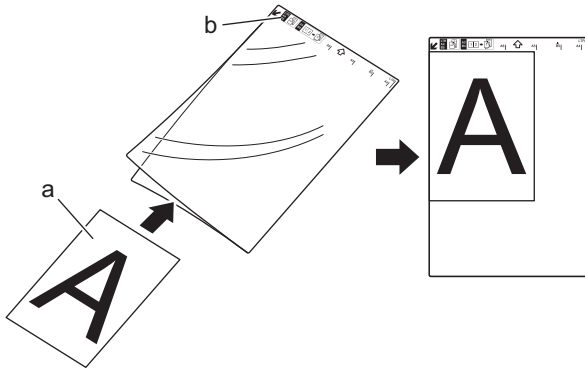

a. Document is Face Up

b. Carrier Sheet Header is Face Up

2. Set the Carrier Sheet, *face up* with the header first in the Feeder Slot and align the left edge of the Carrier Sheet with the Left Edge of the Feeder Slot.

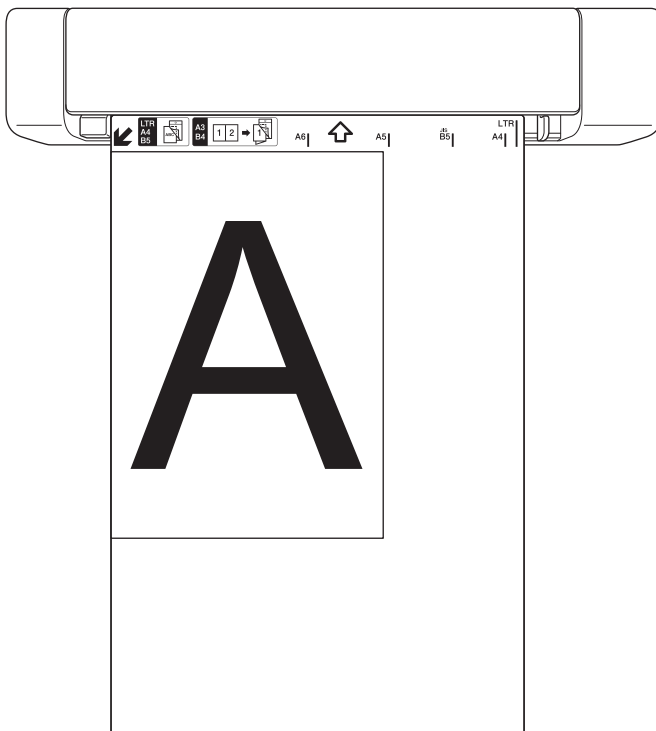

If the receipt is longer than the Carrier Sheet, you can fold the receipt in two places so that it overlaps when you insert it into the Carrier Sheet.

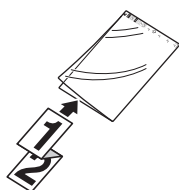

3. Slide the Document Guide until it touches the right side of the Carrier Sheet.

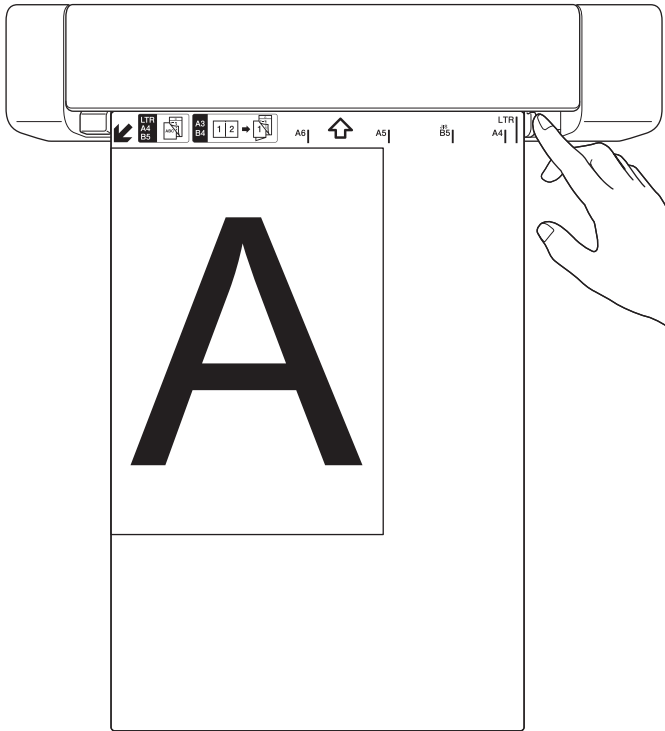

4. Gently insert the Carrier Sheet until you feel its top edge touch the inside of the scanner.



Related Information

- [Load Documents](#)
-

Use the Output Guide

Related Models: DSmobile DS-740D/DSmobile DS-940DW

Use the Output Guide if there is not enough space behind the scanner.
The scanned document is ejected as follows:

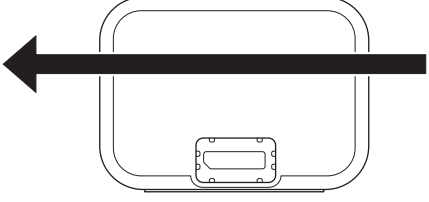
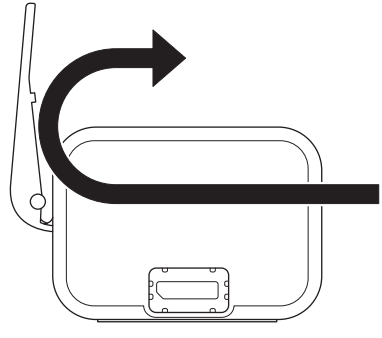
When the Output Guide is closed.	
When the Output Guide is open.	

- Confirm the paper size and weight can be used to scan documents using the Output Guide.
See *Related Information: Acceptable Documents*.
- Do not use the Carrier Sheet with the Output Guide.
- Do not scan plastic cards using the Output Guide.
- For better scan results, when scanning documents in high or low temperatures and humidity, we recommend not using the Output Guide.

- Open the Output Guide to support scanned documents.

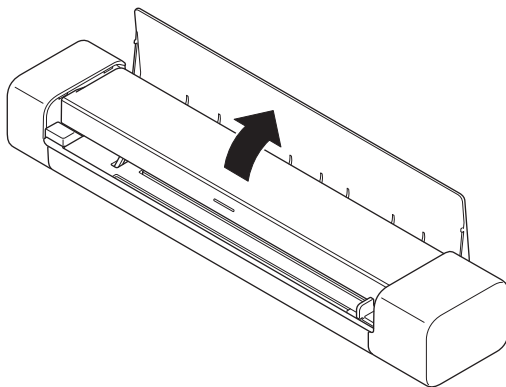

✓ Related Information

- [Load Documents](#)

Related Topics:

- [Acceptable Documents](#)
-

Scan

- [Before Scanning](#)
- [Scan Using the Scan Functions on Your Brother Machine](#)
- [Scan from Your Computer \(Windows\)](#)
- [Scan from Your Computer \(Mac\)](#)
- [Scan Using Brother iPrint&Scan for Mobile](#)
- [Scan Using Presto! BizCard](#)

Before Scanning

Before scanning, confirm the following:

- Make sure you have installed the scanner driver. For more information about installing the scanner driver, see the *Quick Setup Guide*.
- If your Brother machine is connected via a USB cable, make sure the cable is physically secure.



(DSmobile DS-940DW) When using the wireless feature, make sure the scanner is turned on and is connected to the same network as your computer.

Scan Using the Scan Functions on Your Brother Machine

- [Save Scanned Documents on Your Computer](#)
- [Save Scanned Documents to a Memory Card](#)
- [Web Services for Scanning on Your Network \(Windows 7, Windows 8.1 and Windows 10\)](#)
- [Restrict Scan Functions from External Devices](#)

Save Scanned Documents on Your Computer

>> [DSmobile DS-640/DSmobile DS-740D](#)

>> [DSmobile DS-940DW](#)

DSmobile DS-640/DSmobile DS-740D

Use Brother iPrint&Scan to change scan settings, such as resolution, file size or scan type. Go to your model's **Downloads** page at support.brother.com to download the latest application.



1. Load your document.
2. Press **START/STOP** on the control panel.
The machine starts scanning.

DSmobile DS-940DW

Use Brother iPrint&Scan to change scan settings, such as resolution, file size or scan type. Go to your model's **Downloads** page at support.brother.com to download the latest application.



If the machine and computer are connected wirelessly, configure the Scan to PC settings using Remote Setup.

1. Slide the Mode Select Switch to  or .
2. Load your document.
3. Press **START/STOP** on the control panel.
The machine starts scanning.

✓ Related Information

- [Scan Using the Scan Functions on Your Brother Machine](#)

Related Topics:

- [Brother iPrint&Scan for Windows and Mac](#)

Save Scanned Documents to a Memory Card

Related Models: DSmobile DS-940DW

You must format the microSD memory card first using a computer.

1. Slide the Mode Select Switch to .
2. Gently insert the microSD memory card into the scanner's Memory Card Slot with the metal contact points facing upward.

The SD Card LED lights in white.

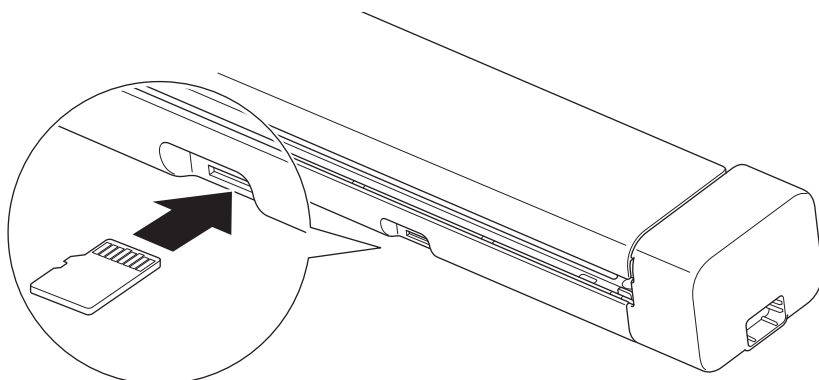

3. Adjust the scan settings by pressing the Colour/Mono, PDF/JPEG, or 2side/1side Switching Buttons on the control panel as needed.



Use Remote Setup to change scan settings, such as document size, or resolution.

4. Load your document.

The machine starts scanning automatically.

When finished, the scanned image is stored on the microSD memory card.



Related Information

- [Scan Using the Scan Functions on Your Brother Machine](#)
 - [Access Scanned Images on the Memory Card](#)

Access Scanned Images on the Memory Card

Related Models: DSmobile DS-940DW

Make sure you slide the Mode Select Switch to  and insert the microSD memory card into the Memory Card Slot.

>> [Windows](#)

>> [Mac](#)

Windows

1. Connect the machine to your computer using a USB cable.
2. Access the folder on the microSD memory card.
3. Double-click **Brother**, and select the image you want.

Mac

1. Connect the machine to your computer using a USB cable.
2. The **Photos** application launches automatically and the scanned images on the microSD memory card appear.



Related Information

- [Save Scanned Documents to a Memory Card](#)

Web Services for Scanning on Your Network (Windows 7, Windows 8.1 and Windows 10)

Related Models: DSmobile DS-940DW

The Web Services protocol enables Windows 7, Windows 8.1 and Windows 10 users to scan using a Brother machine on the network. You must install the driver via Web Services.

- [Use Web Services to Install Drivers Used for Scanning \(Windows 7, Windows 8.1 and Windows 10\)](#)
- [Configure Scan Settings for Web Services \(Windows\)](#)

Use Web Services to Install Drivers Used for Scanning (Windows 7, Windows 8.1 and Windows 10)

Related Models: DSmobile DS-940DW

Use Web Services to monitor scanners on the network.

- Make sure you have installed the Brother software and drivers.
- Verify that the host computer and the Brother machine are on the same subnet, or that the router is correctly configured to pass data between the two devices.
- You must configure the IP address on your Brother machine before you configure this setting.

1. Do one of the following:

- Windows 10

Click  > **Windows System** > **Control Panel**. In the **Hardware and Sound** group, click **Add a device**.

- Windows 8.1

Move your mouse to the lower-right corner of your desktop. When the menu bar appears, click **Settings** > **Change PC settings** > **PC and devices** > **Devices** > **Add a device**.

The machine's Web Services Name appears.

- Windows 7

Click  (**Start**) > **Control Panel** > **Network and Internet** > **View network computers and devices**.

The machine's Web Services Name appears with the scanner icon.

Right-click the machine you want to install.



- The Web Services Name for the Brother machine is your model name and the MAC Address (Ethernet Address) of your machine (for example, Brother XXX-XXXXX (model name) [XXXXXXXXXXXXX] (MAC Address / Ethernet Address)).

- Windows 8.1/Windows 10

Move your mouse over the machine name to display the machine's information.

2. Do one of the following:

- Windows 8.1/Windows 10

Select the machine you want to install, and then follow the on-screen instructions.

- Windows 7

Click **Install** in the displayed menu.



To uninstall drivers, click **Uninstall** or  (**Remove device**).





Related Information

- [Web Services for Scanning on Your Network \(Windows 7, Windows 8.1 and Windows 10\)](#)

Configure Scan Settings for Web Services (Windows)

Related Models: DSmobile DS-940DW

1. Do one of the following:
 - Windows 10
Click  > **Windows System** > **Control Panel**. In the **Hardware and Sound** group, click **View devices and printers**.
 - Windows 8.1
Move your mouse to the lower-right corner of your desktop. When the menu bar appears, click **Settings**, and then click **Control Panel**. In the **Hardware and Sound** group, click **View devices and printers**.
 - Windows 7
Click  (**Start**) > **Devices and Printers**.
2. Right-click the machine icon, and then select **Scan profiles....**
The **Scan profiles...** dialog box appears.
3. Select the scan profile you want to use.
4. Make sure the scanner selected in the **Scanner** list is a Brother machine that supports Web Services for scanning, and then click the **Set as Default** button.
5. Click **Edit....**
The **Edit Default Profile** dialog box appears.
6. Select the **Source**, **Paper size**, **Color format**, **File type**, **Resolution (DPI)**, **Brightness** and **Contrast** settings.
7. Click the **Save Profile** button.
These settings will be applied when you scan using the Web Services protocol.

If you are prompted to select a scanning application, select Windows Fax and Scan or Windows Photo Gallery from the list.



Related Information



- [Web Services for Scanning on Your Network \(Windows 7, Windows 8.1 and Windows 10\)](#)

Restrict Scan Functions from External Devices

Related Models: DSmobile DS-940DW

This feature allows you to restrict scan functions from external devices. When you restrict scan functions from external devices, users cannot use those scan functions.

We recommend using Microsoft Internet Explorer 11 or later/Microsoft Edge for Windows, and Safari 12 or later for Mac. Make sure that JavaScript and Cookies are always enabled in whichever browser you use. If a different web browser is used, make sure it is compatible with HTTP 1.0 and HTTP 1.1.

1. Slide the Mode Select Switch to .
 2. Start your web browser.
 3. Do one of the following:
 - When using Wireless Direct
Type "https://192.168.118.1" in your browser's address bar.
 - When using infrastructure mode
Type "https://machine's IP address" in your browser's address bar (where "machine's IP address" is the machine's IP address).
For example:
https://192.168.1.2
- If the machine prompts you for a password, type it, and then click . If you have not previously set your own password, type the default login password. The default password for managing machine settings is either:
- the password located on the bottom of the machine and preceded by "**Pwd**".
 - **initpass**
4. Click the **Scan** tab.
 5. Click the **Scan from PC** menu in the left navigation bar.
 6. Disable the **Pull Scan** option.
 7. Click **Submit**.



Related Information

- [Scan Using the Scan Functions on Your Brother Machine](#)

Related Topics:

- [Check the IP Address of Network Devices](#)
- [Use Wireless Direct](#)
- [Use Infrastructure Mode](#)

Scan from Your Computer (Windows)

There are several ways you can use your computer to scan documents on your Brother machine. Use the software applications provided by Brother, or use your favourite scanning application.

- [Scan Using Nuance™ PaperPort™ 14SE or Other Windows Applications](#)
- [Scan Using Windows Photo Gallery or Windows Fax and Scan](#)
- [Scan Using Kofax Power PDF Standard v3](#)
- [Scan Using Brother iPrint&Scan \(Windows\)](#)



Scan Using Nuance™ PaperPort™ 14SE or Other Windows Applications

You can use the Nuance™ PaperPort™ 14SE application, which is included in the scanner driver, for scanning.

For detailed instructions on using each application, click the application's **Help** menu, and then click **Getting Started Guide** in the **Help** ribbon.



The instructions for scanning in these steps are for Nuance™ PaperPort™ 14SE. For other Windows applications, the steps will be similar. Nuance™ PaperPort™ 14SE supports both TWAIN and WIA drivers; the TWAIN driver (recommended) is used in these steps.

1. Load your document.
2. Start Nuance™ PaperPort™ 14. Do one of the following:
 - Windows 10
Click  > **Nuance PaperPort 14** > **PaperPort**.
 - Windows 8.1
Click  (**PaperPort**).
 - Windows 7
Click  (**Start**) > **All Programs** > **Nuance PaperPort 14** > **PaperPort**.
3. Click the **Desktop** menu, and then click **Scan Settings** in the **Desktop** ribbon.
The **Scan or Get Photo** panel appears on the left side of the screen.
4. Click **Select**.
5. From the available Scanners list, select **TWAIN: TW-Brother XX-XXXXX** (where XXXXX is the model name of your machine). To use the WIA driver, select the Brother driver that has "WIA" as the prefix.
6. Select the **Display scanner dialog box** check box in the **Scan or Get Photo** panel.
7. Click **Scan**.
The Scanner Setup dialog box appears.

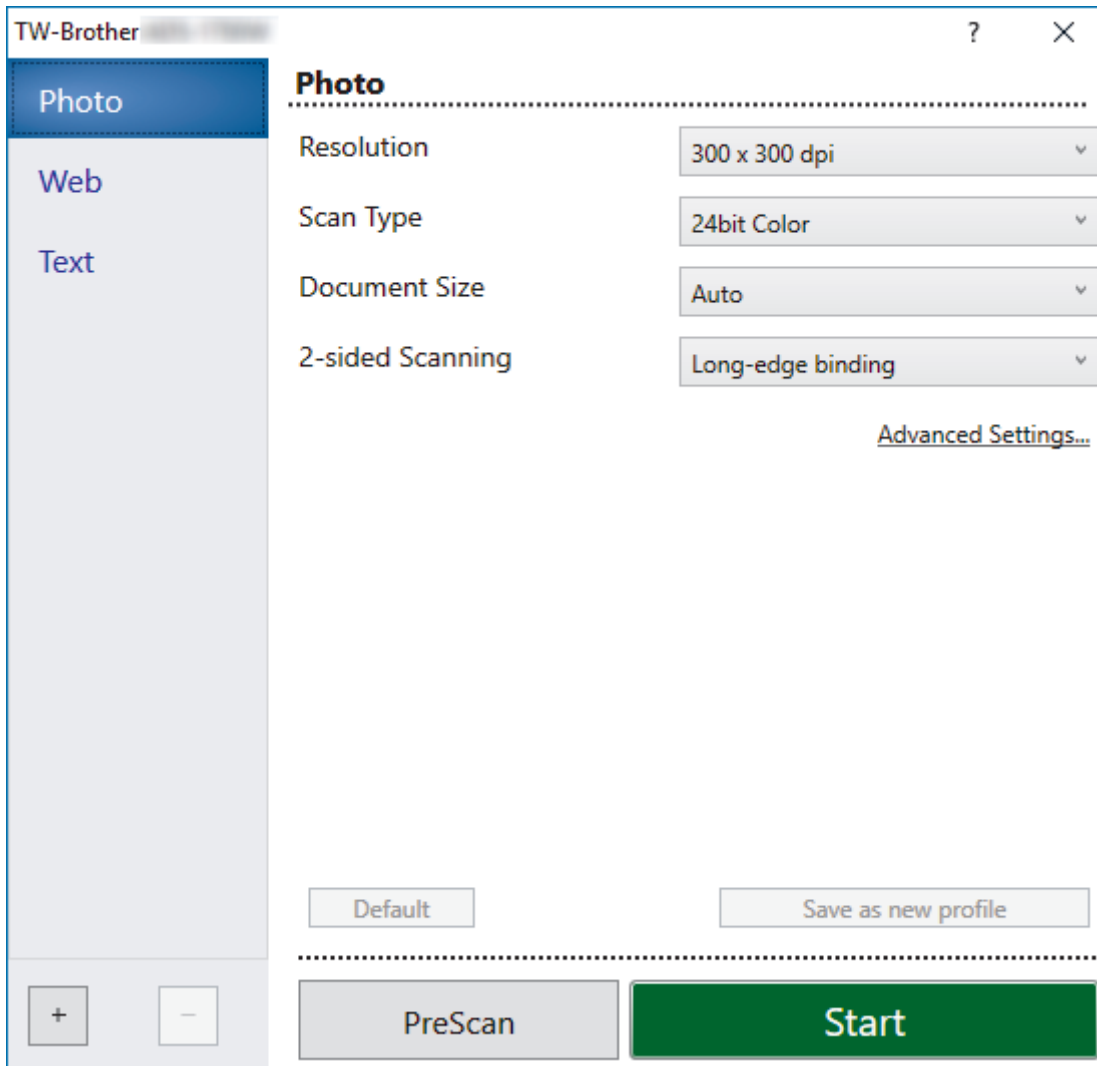

8. Adjust the settings in the Scanner Setup dialog box, if needed.
9. Click the **Document Size** drop-down list, and then select your document size.
10. Click **PreScan** to preview your image and crop unwanted portions before scanning.
11. Click **Start**.

The machine starts scanning.



Related Information

- [Scan from Your Computer \(Windows\)](#)
- [TWAIN Driver Settings \(Windows\)](#)

TWAIN Driver Settings (Windows)

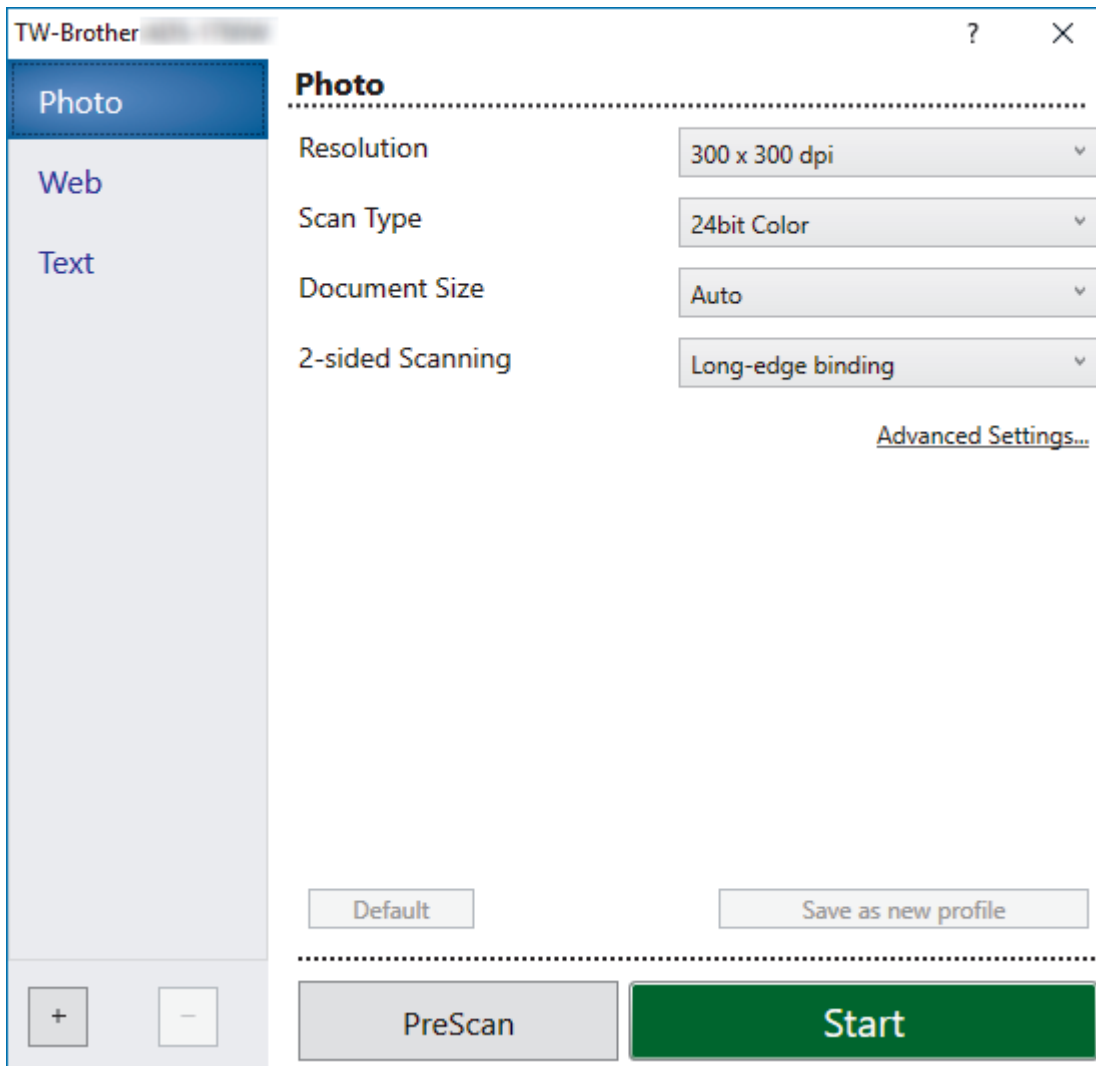

Note that the item names and assignable values will vary depending on the machine.

1. Scan

Select the **Photo**, **Web**, or **Text** option depending on the type of document you want to scan.

Scan (Image Type)		Resolution	Scan Type
Photo	Use for scanning photo images.	300 x 300 dpi	24bit Colour
Web	Use for attaching the scanned image to web pages.	100 x 100 dpi	24bit Colour
Text	Use for scanning text documents.	200 x 200 dpi	Black & White

2. Resolution

Select a scanning resolution from the **Resolution** drop-down list. Higher resolutions produce a finer scanned image but consume more memory and increase transfer time.

3. Scan Type

Select from a range of scan colour depths.

- **Auto**

Automatically detects whether the document uses colour and generates a scanned image of it. For documents that mix colour and monochrome pages, colour pages will be scanned in Colour mode, while monochrome pages will be scanned in **Black & White** mode.

- **Black & White**

Use for text or line art images.

- **Grey (Error Diffusion)**

Use for photographic images or graphics. (Error Diffusion is a method for creating simulated greyscale images without using true grey dots. Black dots are put in a specific pattern to give a grey appearance.)

- **True Grey**

Use for photographic images or graphics. This mode is more accurate because it uses up to 256 shades of grey.

- **24bit Colour**

Use to create an image with the most accurate colour reproduction. This mode uses up to 16.8 million colours to scan the image, but it requires the most memory and has the longest transfer time.

4. Document Size

Select the exact size of your document from a selection of preset scan sizes. If you select **Custom**, the **Custom Document Size** dialog box appears and you can specify the document size.



(DSmobile DS-640/DSmobile DS-740D) **Auto** is not available for scanning at resolutions greater than 400 x 400 dpi.

5. 2-sided Scanning (DSmobile DS-740D/DSmobile DS-940DW)

Scan both sides of the document. Select **Long-edge binding** or **Short-edge binding** depending on the layout of your original to make sure the data file created appears correctly in the scanned document.



2-sided Scanning is not available for **Long Paper**.

2-sided Scan Setting	Original Layout	Scan Result
Long-edge binding		
Short-edge binding		

6. Advanced Settings...

Configure advanced settings by clicking the **Advanced Settings...** button in the Scanner Setup dialog box.

- **Document Correction**

- **Cropping**

- **Auto Deskew**

Set the machine to correct document skewing automatically.



- **Auto Deskew** feature is automatically set to On if you select **Auto** for the **Document Size**.
- (DSmobile DS-640/DSmobile DS-740D) **Auto Deskew** is not available for scanning at resolutions greater than 400 x 400 dpi.

- **Detect End of Page**

Detects the end of page and automatically adjusts the size of a page when the length of the document is shorter than the **Document Size** selected.

- **Margin Settings**

This feature allows you to add or remove a specific margin at the edge of the image. A positive value decreases the size of the scanned image when it is output and a negative value increases the size of the scanned image when it is output.



Margin Settings is available only when **Document Size** is set to **Auto**.

- **Rotate Image**

Changes the direction of the document based on the text orientation when **Auto** is selected.

- **Edge Fill**

Fill in the edges on four sides of the scanned image using the selected colour and range.

- **Auto Colour Detect Adjust**

When scan type **Auto** is selected, you can adjust the detection level of colour. Increasing the slider value makes the machine more likely to determine that a given document is a colour document.

- **Skip Blank Page**

Remove the document's blank pages from the scanning results.

- **Enhancement**

- **Diffusion Adjustment -Grey**

This function adjusts the brightness and contrast to create grey images.



Only available when the **Scan Type** is **Grey (Error Diffusion)**.

Brightness

Set the **Brightness** level by moving the slider to the right or left to lighten or darken the image. If the scanned image is too light, set a lower brightness level and scan the document again. If the image is too dark, set a higher brightness level and scan the document again. You can also type a value in the field to set the brightness.

Contrast

Increase or decrease the **Contrast** level by moving the slider to the right or left. An increase emphasises dark and light areas of the image, while a decrease reveals more details in grey areas. You can also type a value in the field to set the contrast.

- **Colour Tone Adjustment**

Allows you to adjust the brightness, contrast and gamma during True grey and colour scanning.

- **Background Processing**

- **Remove Bleed-through / Pattern**

Prevent any visible text or images from the other side of the document from appearing on the scan.

- **Remove Background Colour**

Remove the base colour of documents to make the scanned data more legible.

- **Colour Drop**

Select a colour to remove from the scanned image.

- **Edge Emphasis**

Make the characters of the original sharper.



The following items can be selected when scanning colour or grey images:

- **Colour Tone Adjustment**
- **Edge Emphasis**

- **B&W Image Quality**
 - **B&W Threshold Adjustment**

This setting allows you to adjust the image quality when scanning in **Black & White** mode. Larger values increase the amount of black in the scanned image, while smaller values increase the amount of white. Use this setting to improve the quality of documents scanned using the OCR (Optical Character Recognition) technology.
 - **Character Correction**

Correct any broken or incomplete characters in the original to make them easier to read.



Character Correction can be selected when scanning monochrome images.

- **B&W Inversion**

This feature allows you to create a monochrome inverted version of the scanned image.
- **Feed Control**
 - **Layout**

Allows you to scan a two-page document combined into one page, or scan a one-page document divided into two pages.
 - **Carrier Sheet Mode**

Use the Carrier Sheet (not included) to scan the following document types:

 - Important documents (photos, contracts)
 - Thin paper (receipts)
 - Irregularly-shaped paper (clippings)
 - **Continuous Scan**

Select this option to scan additional documents using the same settings when a scan has been completed.
- **Additional Functions**
 - **Barcode Detection**

The machine reads the barcode printed on the scanned image. Specify the barcode type and detection area.



-
- **Barcode Detection** is available when **Layout** is Off.
 - To scan and read barcodes, use a third-party application. The TWAIN driver alone cannot convert barcodes into data.

-
- **JPEG Compression**

Changes the quality of the JPEG file to be saved.



This function is available only when using a third-party application with Disk File mode.



Related Information

- [Scan Using Nuance™ PaperPort™ 14SE or Other Windows Applications](#)
-

Scan Using Windows Photo Gallery or Windows Fax and Scan

Windows Photo Gallery or Windows Fax and Scan applications are other options that you can use for scanning.

These applications use the WIA scanner driver.

1. Load your document.
2. Launch your scanning application. Do one of the following:
 - Windows Photo Gallery (Windows 7)
Click **File** > **Import from Camera or Scanner**.
 - Windows Fax and Scan
Click **File** > **New** > **Scan**.
3. Select the scanner you want to use.
4. Click **Import** or **OK**.

The **New Scan** dialog box appears.

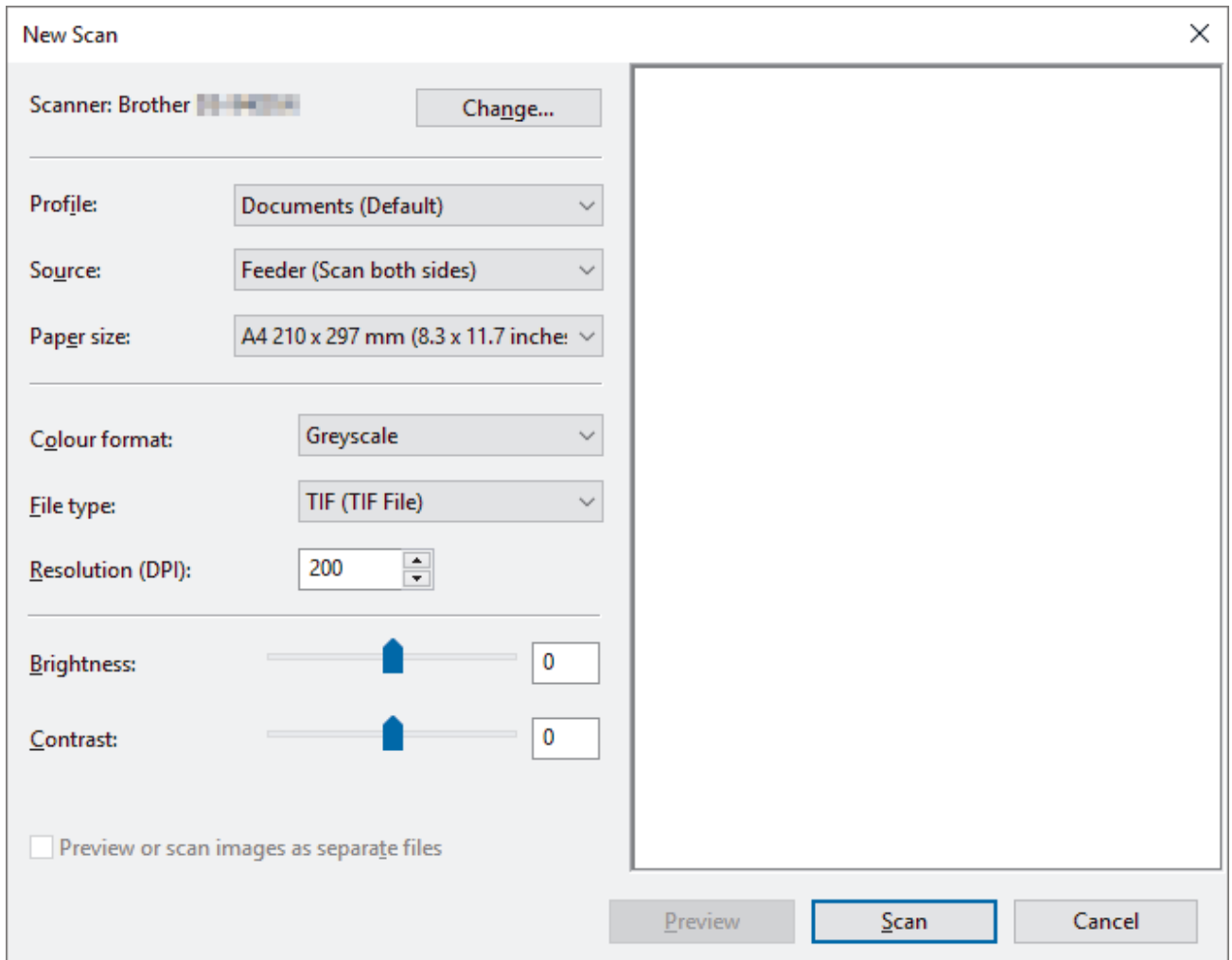

5. Adjust the settings in the Scanner Setup dialog box, if needed.
6. Click **Scan**.

The machine starts scanning.

✓ Related Information

- [Scan from Your Computer \(Windows\)](#)

-
- WIA Driver Settings (Windows)
-

WIA Driver Settings (Windows)

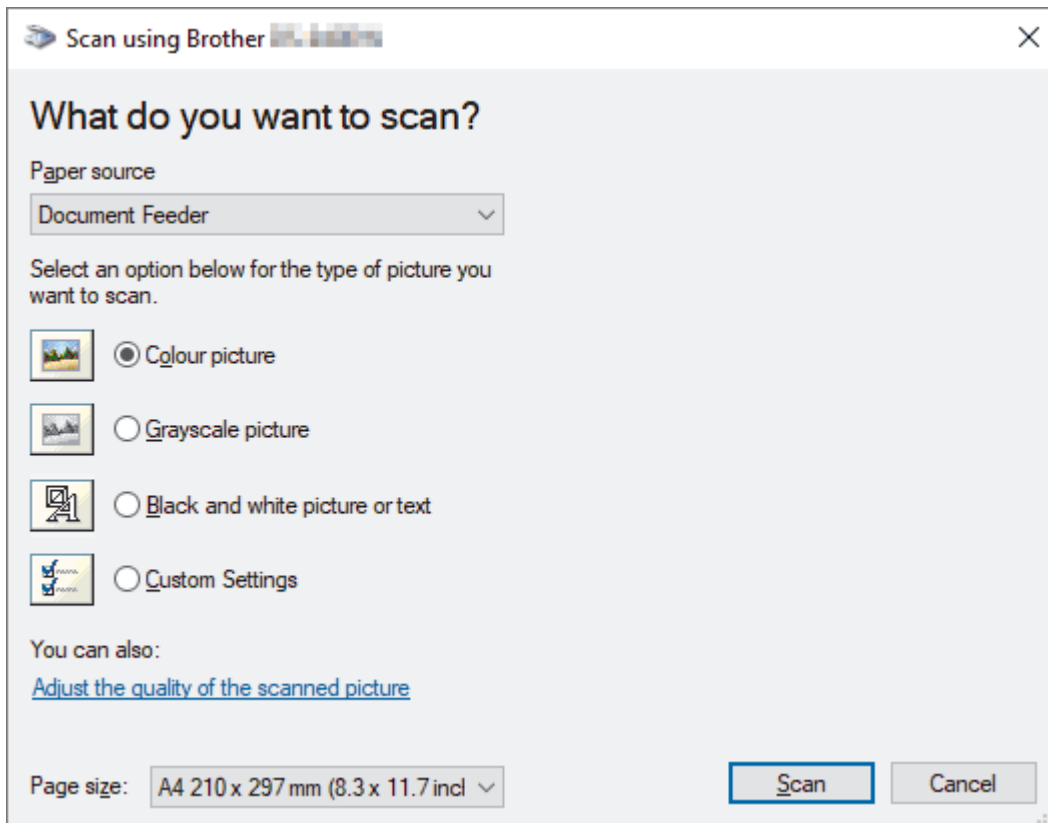

1. Paper source

You can select **Document Feeder** only.

2. Picture Type (Image Type)

Select **Color picture**, **Grayscale picture**, **Black and white picture or text**, or **Custom Settings** for the type of document you want to scan.

To change advanced settings, click the **Adjust the quality of the scanned picture** link.

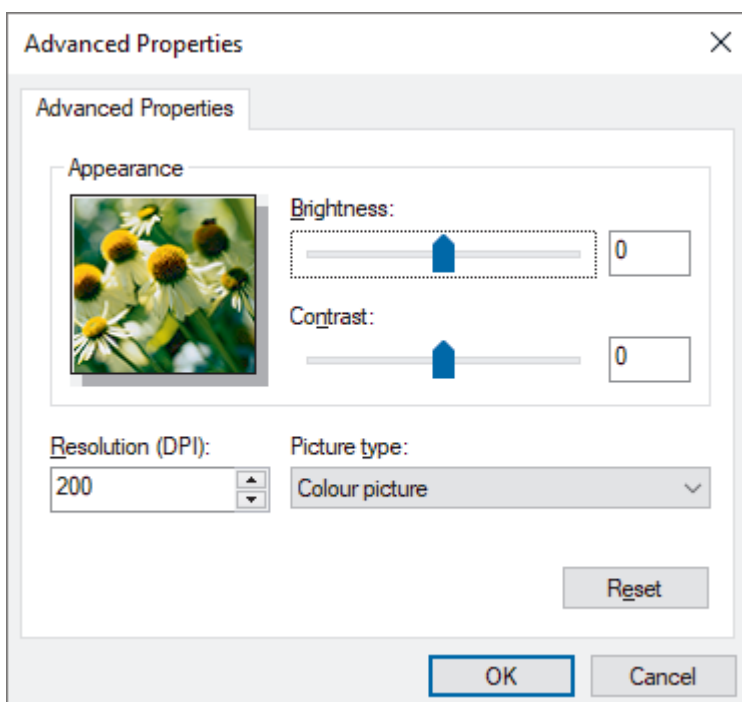

1. **Brightness**

Set the **Brightness** level by moving the slider to the right or left to lighten or darken the image. If the scanned image is too light, set a lower brightness level and scan the document again. If the image is too dark, set a higher brightness level and scan the document again.

2. **Contrast**

Increase or decrease the **Contrast** level by moving the slider to the right or left. An increase emphasises dark and light areas of the image, while a decrease reveals more details in grey areas. You can also type a value in the field to set the contrast level.

3. **Resolution (DPI)**

Select a scanning resolution from the **Resolution (DPI)** list. Higher resolutions produce a finer scanned image but consume more memory and increase transfer time.

4. **Picture type**

Select or change the type of document you want to scan.



Related Information

- [Scan Using Windows Photo Gallery or Windows Fax and Scan](#)
-

Scan Using Kofax Power PDF Standard v3

You can use the Kofax Power PDF application for scanning. It converts the scanned PDF data into other formats including Microsoft Word, Microsoft Excel, Microsoft PowerPoint, images and more. If you are asked to enter the serial number when installing the software, check the label attached to the scanner. Within the application, see the Kofax Power PDF Help menu, for more information.





Related Information

- [Scan from Your Computer \(Windows\)](#)
-

Scan Using Brother iPrint&Scan (Windows)

Use Brother iPrint&Scan for Windows to scan from your computer. Go to your model's **Downloads** page at support.brother.com to download it.

1. Start Brother iPrint&Scan. Do one of the following:
 - Windows 10
Click  > **Brother** > **Brother iPrint&Scan**.
 - Windows 8.1
Click **Brother iPrint&Scan**.
 - Windows 7
Click  (**Start**) > **All Programs** > **Brother iPrint&Scan**.
2. If your Brother machine is not selected, click the **Select your Machine** button, and then follow the on-screen instructions to select your Brother machine.
3. Click the **Scan** icon, and then follow the on-screen instructions to scan your documents.



Related Information

- [Scan from Your Computer \(Windows\)](#)

Related Topics:

- [Brother iPrint&Scan Overview](#)

Scan from Your Computer (Mac)

There are several ways you can use your Mac to scan documents on your Brother machine. Use the software applications provided by Brother or your favourite scanning application.

- [Scan Using Brother iPrint&Scan \(Mac\)](#)
- [Scan Using Apple Image Capture \(ICA Driver\)](#)
- [Using AirPrint Scanning](#)

Scan Using Brother iPrint&Scan (Mac)

Use Brother iPrint&Scan for Mac to scan from your computer. Download and install Brother iPrint&Scan from the App Store.

1. In the **Finder** menu bar, click **Go > Applications**, and then double-click the iPrint&Scan icon.
The Brother iPrint&Scan screen appears.
2. If your Brother machine is not selected, click the **Select your Machine** button, and then follow the on-screen instructions to select your Brother machine.
3. Click the **Scan** icon, and then follow the on-screen instructions to scan your documents.



Related Information

- [Scan from Your Computer \(Mac\)](#)

Related Topics:

- [Brother iPrint&Scan Overview](#)
-

Scan Using Apple Image Capture (ICA Driver)

Download and install the ICA driver at support.brother.com. You can also scan directly using the **Image Capture** application.



Related Information

- [Scan from Your Computer \(Mac\)](#)
 - [Scan Using Apple Image Capture](#)
 - [ICA Driver Settings](#)
-

Scan Using Apple Image Capture

1. Launch the **Image Capture** application.



2. Select the machine from the list on the left side of the screen.

If you connected the Brother machine to your Mac with a USB cable, you will see the machine in the **DEVICES** area. If connected via a network, you will see it in the **SHARED** area.

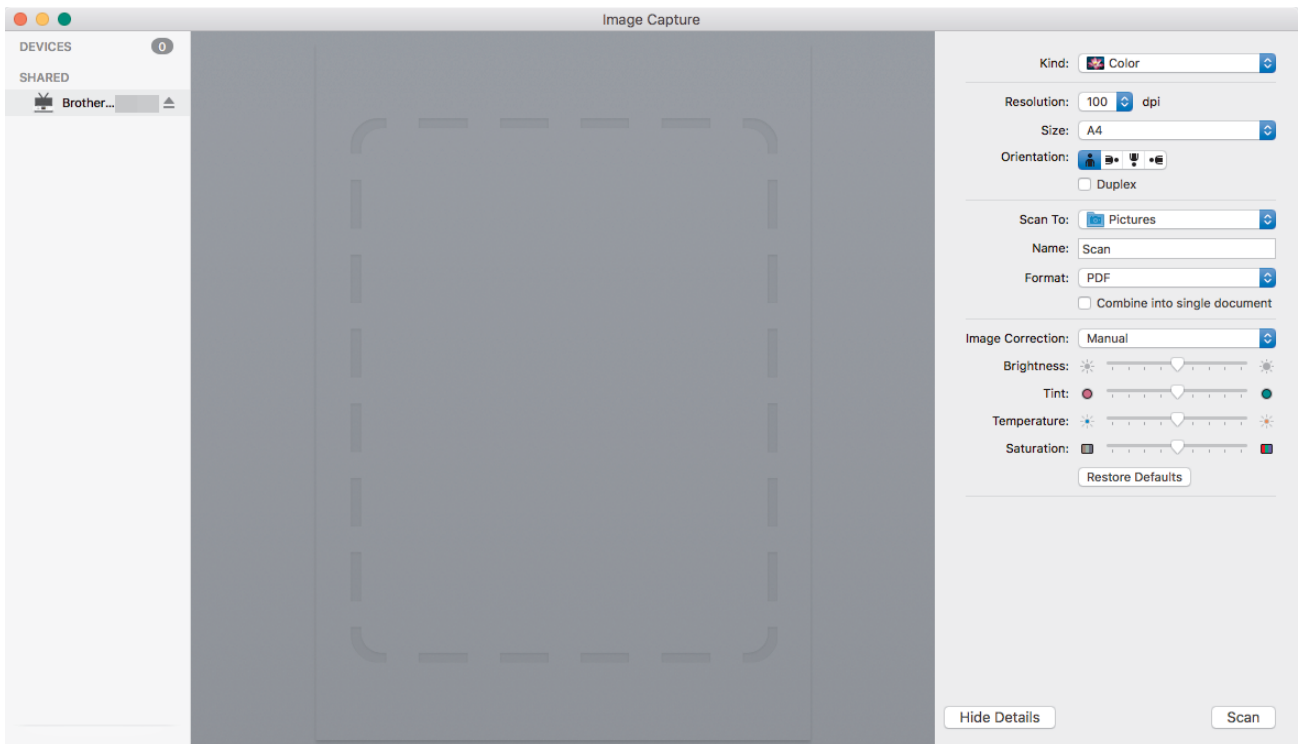

3. Load your document.
4. Select the size of your document.
5. Select the destination folder or destination application from the **Scan To** pop-up menu.
6. Click **Scan**.

The machine starts scanning.

✓ Related Information

- [Scan Using Apple Image Capture \(ICA Driver\)](#)

ICA Driver Settings

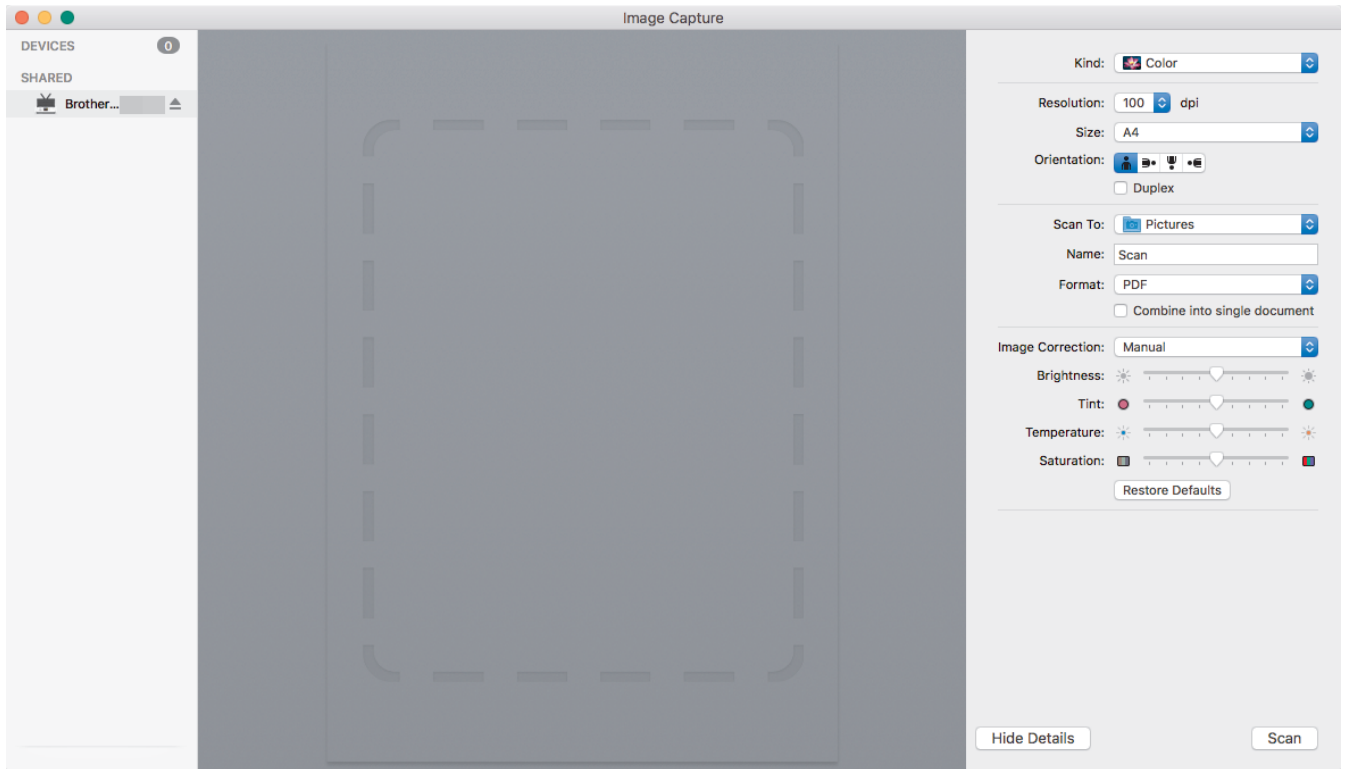

To adjust image capture settings, click **Show Details**.



Item names and assignable values may vary depending on the machine.

1. Kind

Allows you to select from **Color**, **Black&White**, or **Text**.

2. Resolution

Specifies the document resolution you want.

3. Scan Size/Size

Specifies the paper size of the document.

4. Orientation

Specifies the orientation of the document.

5. Duplex (supported models only)

Allows you to select the **Duplex** check box to perform 2-sided (duplex) scanning.

6. Scan To

Specifies the destination folder or destination application.

7. Name

Allows you to enter the prefix text used for the name of the scanned image.

8. Format

Specifies the file format of the scanned data.

9. Combine into single document

Allows you to scan a document as one item and save it as one file when selecting PDF or TIFF for the file format.

10. Image Correction

Depending on the **Kind** option selected, it allows you to configure the following settings:

Kind	Configurable Settings
Color	Brightness, Tint, Temperature, Saturation
Black&White	Brightness, Contrast
Text	Threshold



Related Information

- [Scan Using Apple Image Capture \(ICA Driver\)](#)
-

Using AirPrint Scanning

Related Models: DSmobile DS-940DW

- [Before Using AirPrint Scanning](#)
- [Scan Using AirPrint Scanning](#)

Before Using AirPrint Scanning

Related Models: DSmobile DS-940DW

Before using AirPrint Scanning, add your Brother machine to the scanner list on your Mac.

- To use this feature, make sure your machine has the latest firmware. To check for the latest firmware upgrade, visit support.brother.com.
- Make sure your Brother machine and Mac are connected either wirelessly or via a USB cable.

1. Select **System Preferences** from the Apple menu.
2. Click **Printers & Scanners**.
3. Click the + icon below the Scanners pane on the left.
The **Add** screen appears.
4. Select your Brother machine, and then select **Brother DS-XXXXX** from the **Use** pop-up menu.
5. Click **Add**.



Related Information

- [Using AirPrint Scanning](#)

Scan Using AirPrint Scanning

Related Models: DSmobile DS-940DW

Before scanning, make sure your Brother machine is in the scanner list on your Mac.

1. Load your document.
2. Select **System Preferences** from the Apple menu.
3. Click **Printers & Scanners**.
4. Select your Brother machine from the scanner list.
5. Click the **Open Scanner...** button.
The Scanner screen appears.
6. Select the destination folder or destination application.
7. Click **Show Details** to change the scanning settings if needed.
8. Click **Scan**.



Related Information

- [Using AirPrint Scanning](#)

Scan Using Brother iPrint&Scan for Mobile

Related Models: DSmobile DS-940DW

- [Brother iPrint&Scan for Mobile Devices](#)

Brother iPrint&Scan for Mobile Devices

Related Models: DSmobile DS-940DW

Use Brother iPrint&Scan to scan from various mobile devices.

- For Android™ Devices:

Brother iPrint&Scan allows you to use features of your Brother machine directly from your Android™ device.

Download and install Brother iPrint&Scan from the Google Play™ Store app.

- For all iOS supported devices including iPhone, iPad and iPod touch:

Brother iPrint&Scan allows you to use your Brother machine's features directly from your iOS device.

Download and install Brother iPrint&Scan from the App Store.

For more information, visit support.brother.com/ips.



Related Information

- [Scan Using Brother iPrint&Scan for Mobile](#)

Related Topics:

- [Brother iPrint&Scan for Windows and Mac](#)

Scan Using Presto! BizCard

Presto! BizCard lets you manage the information from scanned business cards, such as names, companies, phone/fax numbers, mailing, and email addresses, on your computer. Scan or import your business cards and Presto! BizCard automatically saves the data and image for each card. Different viewing modes are available for searching, editing, creating, and sorting.



Related Information

- [Scan](#)
-

Network

Related Models: DSmobile DS-940DW

- [Supported Basic Network Features](#)
- [Network Management Software and Utilities](#)
- [Additional Methods of Configuring Your Brother Machine for a Wireless Network](#)
- [Advanced Network Features](#)

Supported Basic Network Features

Related Models: DSmobile DS-940DW

The machine supports various features depending on the operating system. Use this table to see which network features and connections are supported by each operating system.

Operating Systems	Windows 7 (SP1) Windows 8.1 Windows 10	Windows Server 2012 Windows Server 2012 R2 Windows Server 2016 Windows Server 2019	macOS v10.12.x macOS v10.13.x macOS v10.14.x
Scanning	Yes	Yes	Yes
BRAdmin Light ^{1 2}	Yes	Yes	
Web Based Management (supported models only) ²	Yes	Yes	Yes
Remote Setup ²	Yes		Yes

✓ Related Information

- [Network](#)

¹ BRAdmin Light is available as a download from your model's **Downloads** page at support.brother.com.

² The default password for managing machine settings is either:

- the password located on the bottom of the machine and preceded by "**Pwd**".
- **initpass**

We recommend you change it to protect your machine from unauthorised access.

Network Management Software and Utilities

Related Models: DSmobile DS-940DW

Configure and change your Brother machine's network settings using a management utility.

- [Learn about Network Management Software and Utilities](#)

Learn about Network Management Software and Utilities

Related Models: DSmobile DS-940DW

Web Based Management (supported models only)

Web Based Management is a utility that uses a standard web browser to manage your machine using the Hyper Text Transfer Protocol (HTTP) or Hyper Text Transfer Protocol over Secure Socket Layer (HTTPS). Type your machine's IP address into your web browser to access and change your scanner settings.

BRAdmin Light (Windows) (supported models only)

BRAdmin Light is a utility for the initial setup of Brother network-connected devices. This utility can search for Brother products on your network, view the status and configure the basic network settings, such as IP address.

Go to your model's **Downloads** page at support.brother.com to download the latest version of Brother's BRAdmin Light.



- If using Windows Firewall, or the firewall function of an anti-spyware or antivirus application, temporarily disable them. When you are sure you can scan, configure the software settings by following the manufacturer's instructions.

Remote Setup (Windows and Mac)

Remote Setup is a program for configuring many machine and network settings from either a Windows or a Mac application. When you start this application, the settings on your machine are automatically downloaded to your computer and displayed on your computer screen. If you change the settings, you can upload them directly to the machine.



This utility can be used with either a USB or a network connection.



Related Information

- [Network Management Software and Utilities](#)

Related Topics:

- [Check the IP Address of Network Devices](#)

Additional Methods of Configuring Your Brother Machine for a Wireless Network

Related Models: DSmobile DS-940DW

- [Before Configuring Your Brother Machine for a Wireless Network](#)
- [Configure Your Machine for a Wireless Network Using the One-Push Method of Wi-Fi Protected Setup™ \(WPS\)](#)
- [Configure Your Machine for a Wireless Network Using the PIN Method of Wi-Fi Protected Setup™ \(WPS\)](#)
- [Use Wireless Direct](#)
- [Use Infrastructure Mode](#)

Before Configuring Your Brother Machine for a Wireless Network

Related Models: DSmobile DS-940DW

Before attempting to configure a wireless network, confirm the following:

- Before configuring wireless settings, you must know your Network Name (SSID) and Network Key (Password).



If you do not know this security information, contact the router manufacturer, your system administrator, or your Internet provider.

- To achieve optimum results with normal everyday document scanning, place the Brother machine as close to the wireless access point/router as possible with minimal obstructions. Large objects and walls between the two devices and interference from other electronic devices can affect the data transfer speed of your documents.

Due to these factors, wireless may not be the best method of connection for all types of documents and applications.



Related Information

- [Additional Methods of Configuring Your Brother Machine for a Wireless Network](#)

Configure Your Machine for a Wireless Network Using the One-Push Method of Wi-Fi Protected Setup™ (WPS)

Related Models: DSmobile DS-940DW

If your wireless access point/router supports Wi-Fi Protected Setup™ (WPS), you can use WPS from your machine to configure your wireless network settings.



Routers or access points that support WPS are marked with this symbol:



1. Slide the Mode Select Switch to  .

The Wi-Fi LED blinks.

2. Press and hold the WPS button on your machine for two seconds.

The Wi-Fi LED starts to blink more rapidly.

3. Press the WPS button on your wireless access point/router.

If your machine is connected successfully, the Wi-Fi LED stop blinking and becomes lit.

You have completed the wireless network setup. To install drivers and software necessary for operating your machine, go to your model's **Downloads** page at support.brother.com.

To configure additional Network Settings, use the Web Based Management. See *Related Information: Access Web Based Management*.



Related Information

- [Additional Methods of Configuring Your Brother Machine for a Wireless Network](#)

Related Topics:

- [Access Web Based Management](#)

Configure Your Machine for a Wireless Network Using the PIN Method of Wi-Fi Protected Setup™ (WPS)

Related Models: DSmobile DS-940DW

If your wireless access point/router supports WPS, you can use the Personal Identification Number (PIN) Method to configure your wireless network settings.

The PIN Method is one of the connection methods developed by the Wi-Fi Alliance®. By submitting a PIN created by an Enrollee (your machine) to the Registrar (a device that manages the wireless LAN), you can set up the wireless network and security settings. For more information on how to access WPS mode, see the instructions provided with your wireless access point/router.

Type A

Connection when the wireless access point/router (1) doubles as the Registrar.

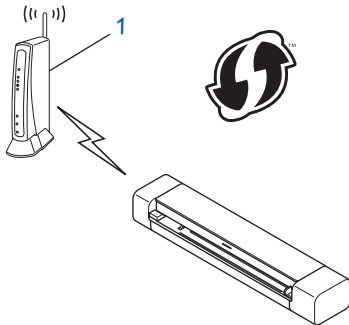

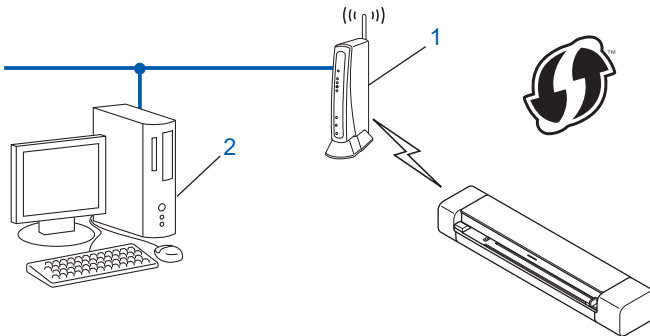

Type B

Connection when another device (2), such as a computer, is used as the Registrar.



 Routers or access points that support WPS are marked with this symbol:



1. Slide the Mode Select Switch to  .
The Wi-Fi LED starts to blink.
2. Press and hold the WPS button on your machine for two seconds.
The Wi-Fi LED blinks rapidly.
3. Press  .
The Wi-Fi LED blinks normally.

-
- Using a computer connected to the network, in your browser's address bar, type the IP address of the device you are using as the Registrar. (For example: <http://192.168.1.2>)
 - Go to the WPS settings page and type the PIN indicated on the label attached to the machine, and then follow the on-screen instructions.



- The Registrar is usually the wireless access point/router.
- The settings page will differ depending on the brand of wireless access point/router. For more detailed information, see the instructions supplied with your wireless access point/router.

If using a Windows 7, Windows 8.1, or Windows 10 computer as a Registrar, complete the following steps:

- Do one of the following:

- Windows 10

Click  > **Windows System** > **Control Panel**. In the **Hardware and Sound** group, click **Add a device**.

- Windows 8.1

Move your mouse to the lower right corner of your desktop. When the menu bar appears, click **Settings** > **Control Panel** > **Hardware and Sound** > **Devices and Printers** > **Add a device**.

- Windows 7

Click  (**Start**) > **Devices and Printers** > **Add a device**.



- To use Windows 7, Windows 8.1, or Windows 10 computer as a Registrar, you must register it to your network in advance. For more detailed information, see the instructions supplied with your wireless access point/router.
- If you use Windows 7, Windows 8.1, or Windows 10 as a Registrar, you can install the scanner driver after the wireless configuration by following the on-screen instructions. To install the full driver and software package, see the *Quick Setup Guide*.

- Select your machine and click **Next**.
- Type the PIN indicated on the label attached to the machine, and then click **Next**.
- (Windows 7 only) Select your network, and then click **Next**.
- Click **Close**.

If your wireless device is connected successfully, the Wi-Fi LED on the machine lights up.



Related Information

- [Additional Methods of Configuring Your Brother Machine for a Wireless Network](#)
-

Use Wireless Direct

Related Models: DSmobile DS-940DW

- [Scan from Your Wireless Device Using Wireless Direct](#)
- [Configure Your Wireless Direct Network](#)

Scan from Your Wireless Device Using Wireless Direct

Related Models: DSmobile DS-940DW

Wireless Direct allows you to configure a secured wireless network between your Brother machine and your wireless device (computer, smartphone, tablet, or similar), without using a wireless router/access point. You can configure a wireless network by manually setting a Network Name (SSID) and Network Key (Password).

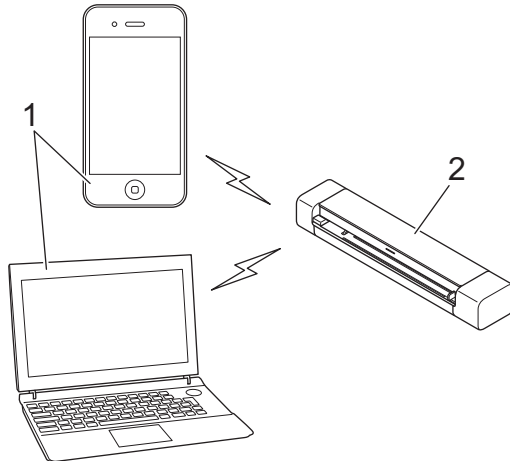

1. Wireless devices
2. Your Brother machine



Related Information

- [Use Wireless Direct](#)

Configure Your Wireless Direct Network

Related Models: DSmobile DS-940DW

1. Slide the Mode Select Switch to .
2. Activate the Wi-Fi function on your wireless device and search for the scanner.
3. Select the scanner's SSID (Network Name) (DIRECT-xxDS-940DW_BRxxxx) on your wireless device.
4. Enter the Network Key (Password) when prompted.



SSID and Network Key are printed on the label attached to the scanner.



Related Information

- [Use Wireless Direct](#)

Use Infrastructure Mode

Related Models: DSmobile DS-940DW

- [Scan from Your Wireless Device Using Infrastructure Mode](#)
- [Configure Wi-Fi Settings in Infrastructure Mode](#)

Scan from Your Wireless Device Using Infrastructure Mode

Related Models: DSmobile DS-940DW

You can connect your wireless device (computer, smartphone, tablet, or similar) to your scanner via a wireless router/access point.

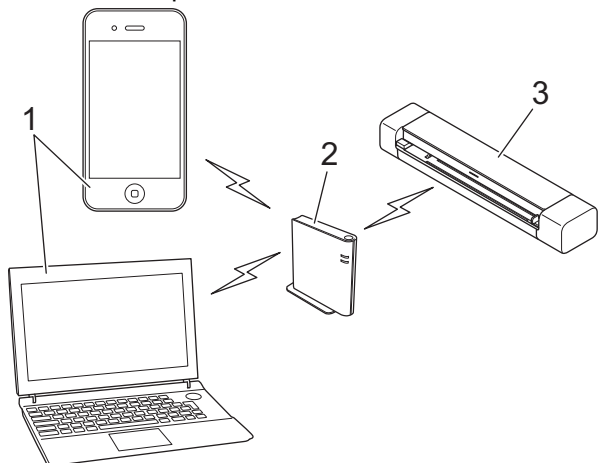

1. Wireless devices
2. Wireless router/access point
3. Your Brother machine



Related Information

- [Use Infrastructure Mode](#)

Configure Wi-Fi Settings in Infrastructure Mode

Related Models: DSmobile DS-940DW

Before configuring your machine, we recommend writing down your wireless network settings. You will need this information before you continue with the configuration.

1. Check and write down the current wireless network settings.

Network Name (SSID)

Network Key (Password)

For example:

Network Name (SSID)
HELLO

Network Key (Password)
12345



If your router uses WEP encryption, enter the Network Key (Password) used as the first WEP key. Your Brother machine supports the use of the first WEP key only.

2. Connect the scanner to your computer using Wireless Direct.
3. Start your web browser.
4. Type "https://192.168.118.1" in your browser's address bar.

If the machine prompts you for a password, type it, and then click . If you have not previously set your own password, type the default login password. The default password for managing machine settings is either:

- the password located on the bottom of the machine and preceded by "**Pwd**".
- **initpass**

5. Click the **Network** tab.
6. Click **Wireless**.
7. Click the **Wireless (Setup Wizard)** menu in the left navigation bar.
8. Click the **Start Wizard** button.
Wireless Setup Wizard starts automatically.
9. Follow the on-screen instructions to complete the wireless network setup.

You have completed the wireless network setup. To install drivers and software necessary for operating your machine, go to your model's **Downloads** page at support.brother.com.

To configure additional Network Settings, use the Web Based Management. See *Related Information: Access Web Based Management*.



Related Information

- [Use Infrastructure Mode](#)

Related Topics:

- [Configure Your Wireless Direct Network](#)
 - [Access Web Based Management](#)
-

Advanced Network Features

Related Models: DSmobile DS-940DW

- [Synchronise Time with the SNTP Server Using Web Based Management](#)

Synchronise Time with the SNTP Server Using Web Based Management

Related Models: DSmobile DS-940DW

The Simple Network Time Protocol (SNTP) is used to synchronise the time used by the machine for authentication with the SNTP time server. You can automatically or manually synchronise the machine's time with the Coordinated Universal Time (UTC) provided by the SNTP time server.

- [Configure Date and Time Using Web Based Management](#)
- [Configure the SNTP Protocol Using Web Based Management](#)

Configure Date and Time Using Web Based Management

Related Models: DSmobile DS-940DW

Configure the date and time to synchronise the time used by the machine with the SNTP time server.

This feature is not available in some countries.

1. Start your web browser.
2. Do one of the following:
 - When using Wireless Direct
Type "https://192.168.118.1" in your browser's address bar.
 - When using infrastructure mode
Type "https://machine's IP address" in your browser's address bar (where "machine's IP address" is the machine's IP address).
For example:
https://192.168.1.2
- If the machine prompts you for a password, type it, and then click . If you have not previously set your own password, type the default login password. The default password for managing machine settings is either:
 - the password located on the bottom of the machine and preceded by "**Pwd**".
 - **initpass**
3. Click the **Administrator** tab.
4. Click **Date&Time** in the left navigation bar.



Date&Time

Date / /

Clock Type 12h Clock 24h Clock

Time : AM

Time Zone

Auto Daylight Off On

Synchronize with SNTP server

To synchronize the "Date&Time" with your SNTP server you must configure the SNTP server settings.

[SNTP>>](#)

5. Select the time difference between your location and UTC from the **Time Zone** drop-down list.
For example, the time zone for Eastern Time in the USA and Canada is UTC-05:00.
6. Select the **Synchronize with SNTP server** check box.

7. Click **Submit**.



Related Information

- [Synchronise Time with the SNTP Server Using Web Based Management](#)

Related Topics:

- [Check the IP Address of Network Devices](#)
-

Configure the SNTP Protocol Using Web Based Management

Related Models: DSmobile DS-940DW

Configure the SNTP protocol to synchronise the time the machine uses for authentication with the time kept by the SNTP time server.

This feature is not available in some countries.

1. Start your web browser.
2. Do one of the following:
 - When using Wireless Direct
Type "https://192.168.118.1" in your browser's address bar.
 - When using infrastructure mode
Type "https://machine's IP address" in your browser's address bar (where "machine's IP address" is the machine's IP address).
For example:
https://192.168.1.2
- If the machine prompts you for a password, type it, and then click . If you have not previously set your own password, type the default login password. The default password for managing machine settings is either:
 - the password located on the bottom of the machine and preceded by "Pwd".
 - **initpass**
3. Click the **Network** tab.
4. Click the **Protocol** menu in the left navigation bar.
5. Select the **SNTP** check box to activate the settings.
6. Restart your Brother machine to activate the configuration.
7. Next to the SNTP check box, click **Advanced Setting** and configure your settings as needed.

SNTP

Status	Enabled
Synchronization Status	Failed to Synchronize

SNTP Server Method	STATIC 
Primary SNTP Server Address	sntp.brother.com
Primary SNTP Server Port	123
Secondary SNTP Server Address	
Secondary SNTP Server Port	123
Synchronization Interval	1 hour(s)

[Date&Time>>](#)

Option	Description
Status	Displays whether the SNTP protocol is enabled or disabled.
Synchronization Status	Confirm the latest synchronisation status.
SNTP Server Method	Select AUTO or STATIC . <ul style="list-style-type: none"> • AUTO If you have a DHCP server in your network, the SNTP server will obtain the address from that server automatically. • STATIC Type the address you want to use.
Primary SNTP Server Address	Type the server address (up to 64 characters).
Secondary SNTP Server Address	The secondary SNTP server address is used as a backup to the primary SNTP server address. If the primary server is unavailable, the machine will contact the secondary SNTP server.
Primary SNTP Server Port	Type the port number (1-65535).
Secondary SNTP Server Port	The secondary SNTP server port is used as a backup to the primary SNTP server port. If the primary port is unavailable, the machine will contact the secondary SNTP port.
Synchronization Interval	Type the number of hours between server synchronisation attempts (1-168 hours).

8. Click **Submit**.



Related Information

- [Synchronise Time with the SNTP Server Using Web Based Management](#)

Related Topics:

- [Check the IP Address of Network Devices](#)

Security

- [Network Security Features](#)

Network Security Features

Related Models: DSmobile DS-940DW

- [Manage Your Network Machine Securely Using SSL/TLS](#)

Manage Your Network Machine Securely Using SSL/TLS

Related Models: DSmobile DS-940DW

- [Certificates and Web Based Management](#)

Certificates and Web Based Management

Related Models: DSmobile DS-940DW

- [Supported Security Certificate Features](#)
- [Import and Export a CA Certificate](#)
- [Manage Multiple Certificates](#)
- [Create a Self-signed Certificate](#)
- [Install the Self-signed Certificate for Windows users with Administrator Rights](#)
- [Import and Export the Self-signed Certificate on your Brother Machine](#)

Supported Security Certificate Features

Related Models: DSmobile DS-940DW

Your Brother machine supports the use of multiple security certificates, which allows secure management, authentication, and communication with the machine.

The machine can use SSL/TLS communication and supports the following types of security certificates:

- Pre-installed certificate

Your machine has a pre-installed self-signed certificate. This certificate enables you to use SSL/TLS communication without creating or installing a different certificate.



The pre-installed self-signed certificate protects your communication up to a certain level. We recommend using a certificate that is issued by a trusted organisation for better security.

- Self-signed certificate

This machine issues its own certificate. Using this certificate, you can easily use the SSL/TLS communication without creating or installing a different certificate from a CA.

- Certificate from a Certificate Authority (CA)

There are two methods for installing a certificate from a CA. If you already have a certificate from a CA or if you want to use a certificate from an external trusted CA:

- When using a Certificate Signing Request (CSR) from this machine.
- When importing a certificate and a private key.

- Certificate Authority (CA) Certificate

To use a CA certificate that identifies the CA and owns its private key, you must import that CA certificate from the CA before configuring the security features of the Network.



- If you are going to use SSL/TLS communication, we recommend contacting your system administrator first.
- When you reset the machine back to its default factory settings, the certificate and the private key that are installed will be deleted. If you want to keep the same certificate and the private key after resetting the machine, export them before resetting, and then reinstall them.



Related Information

- [Certificates and Web Based Management](#)

Import and Export a CA Certificate

Related Models: DSmobile DS-940DW

1. Start your web browser.
 2. Do one of the following:
 - When using Wireless Direct
Type "https://192.168.118.1" in your browser's address bar.
 - When using infrastructure mode
Type "https://machine's IP address" in your browser's address bar (where "machine's IP address" is the machine's IP address).
For example:
https://192.168.1.2
- If the machine prompts you for a password, type it, and then click . If you have not previously set your own password, type the default login password. The default password for managing machine settings is either:
- the password located on the bottom of the machine and preceded by "**Pwd**".
 - **initpass**
3. Click the **Network** tab.
 4. Click the **Security** tab.
 5. Click **CA Certificate**.
 6. Do one of the following:
 - To import a CA Certificate, click **Import CA Certificate**. Browse to select the file you want to import.
 - To export a CA Certificate, select the certificate you want to export and click **Export**.
 7. Click **Submit**.



Related Information

- [Certificates and Web Based Management](#)

Related Topics:

- [Check the IP Address of Network Devices](#)

Manage Multiple Certificates

Related Models: DSmobile DS-940DW

The multiple certificate feature allows you to use Web Based Management to manage each certificate installed on your machine. In Web Based Management, navigate to the **CA Certificate** screen to view certificate content, delete, or export your certificates.

You can store up to seven CA certificates to use SSL.

We recommend storing one certificate fewer than allowed, reserving an empty spot in case of certificate expiration. When a certificate expires, import a new certificate into the reserved spot, and then delete the expired certificate. This ensures that you avoid configuration failure.



Related Information

- [Certificates and Web Based Management](#)

Create a Self-signed Certificate

Related Models: DSmobile DS-940DW

1. Start your web browser.
2. Do one of the following:
 - When using Wireless Direct
Type "https://192.168.118.1" in your browser's address bar.
 - When using infrastructure mode
Type "https://machine's IP address" in your browser's address bar (where "machine's IP address" is the machine's IP address).
For example:
https://192.168.1.2

If the machine prompts you for a password, type it, and then click . If you have not previously set your own password, type the default login password. The default password for managing machine settings is either:

- the password located on the bottom of the machine and preceded by "**Pwd**".
 - **initpass**
3. Click the **Network** tab.
 4. Click the **Security** tab.
 5. Click the **Certificate** menu in the left navigation bar.
 6. Click **Create Self-Signed Certificate**.
 7. Enter a **Common Name** and a **Valid Date**.
 - The length of the **Common Name** is less than 64 bytes. Enter an identifier, such as an IP address, node name, or domain name to use when accessing this machine through SSL/TLS communication. The node name is displayed by default.
 - A warning will appear if you use the IPPS or HTTPS protocol and enter a different name in the URL than the **Common Name** that was used for the self-signed certificate.
 8. Select your setting from the **Public Key Algorithm** drop-down list. The default setting is **RSA(2048bit)**.
 9. Select your setting from the **Digest Algorithm** drop-down list. The default setting is **SHA256**.
 10. Click **Submit**.
 11. Click the **Network** tab.
 12. Click the **Protocol** menu in the left navigation bar.
 13. Click **HTTP Server Settings**.
 14. Select the certificate you want to configure from the **Select the Certificate** drop-down list.
 15. Click **Submit**.
 16. Click **Yes** to restart your machine.

The self-signed certificate is created and saved in your machine's memory.

To use SSL/TLS communication, the self-signed certificate must be installed on your computer.



Related Information

- [Certificates and Web Based Management](#)





Related Topics:

- [Check the IP Address of Network Devices](#)

Install the Self-signed Certificate for Windows users with Administrator Rights

Related Models: DSmobile DS-940DW

The following steps are for Microsoft Internet Explorer. If you use another web browser, consult the documentation for your web browser to get help with installing certificates.

1. Do one of the following:
 - Windows 10/Windows Server 2016/Windows Server 2019
Click  > **Windows Accessories**.
 - Windows 8.1
Right-click the  (**Internet Explorer**) icon on the taskbar.
 - Windows 7
Click  (**Start**) > **All Programs**.
 - Windows Server 2012/Windows Server 2012 R2
Click  (**Internet Explorer**), and then right-click the  (**Internet Explorer**) icon that appears on the taskbar.
2. Right-click **Internet Explorer**, and then click **Run as administrator**.



If the **More** option appears, click **More**.

If the **User Account Control** screen appears, click **Yes**.

3. Do one of the following:
 - When using Wireless Direct
Type "https://192.168.118.1" in your browser's address bar.
 - When using infrastructure mode
Type "https://machine's IP address" in your browser's address bar to access your machine (where "machine's IP address" is the machine's IP address or the node name that you assigned for the certificate).
4. Click **Continue to this website (not recommended)**.
5. Click **Certificate error**, and then click **View certificates**.

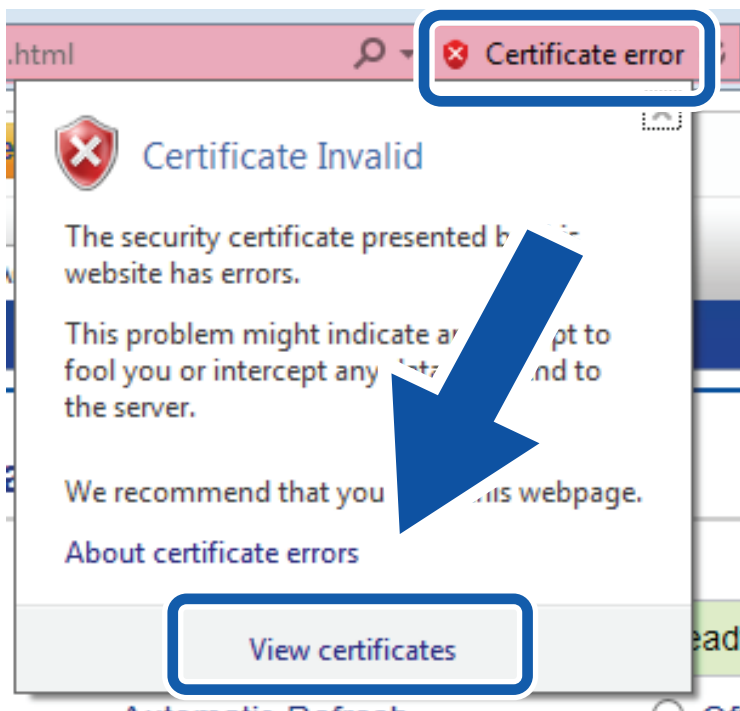

6. Click **Install Certificate....**
7. When the **Certificate Import Wizard** appears, click **Next**.
8. Select **Place all certificates in the following store**, and then click **Browse....**
9. Select **Trusted Root Certification Authorities**, and then click **OK**.
10. Click **Next**.
11. Click **Finish**.
12. Click **Yes**, if the fingerprint (thumbprint) is correct.
13. Click **OK**.

The self-signed certificate is now installed on your computer, and SSL/TLS communication is available.

✓ Related Information

- [Certificates and Web Based Management](#)

Related Topics:

- [Check the IP Address of Network Devices](#)

Import and Export the Self-signed Certificate on your Brother Machine

Related Models: DSmobile DS-940DW

You can store the self-signed certificates on your Brother machine and manage them by importing and exporting.

- [Import the Self-signed Certificate](#)
- [Export the Self-signed Certificate](#)

Import the Self-signed Certificate

Related Models: DSmobile DS-940DW

1. Start your web browser.
2. Do one of the following:
 - When using Wireless Direct
Type "https://192.168.118.1" in your browser's address bar.
 - When using infrastructure mode
Type "https://machine's IP address" in your browser's address bar (where "machine's IP address" is the machine's IP address).
For example:
https://192.168.1.2

If the machine prompts you for a password, type it, and then click . If you have not previously set your own password, type the default login password. The default password for managing machine settings is either:

- the password located on the bottom of the machine and preceded by "**Pwd**".
 - **initpass**
3. Click the **Network** tab.
 4. Click the **Security** tab.
 5. Click the **Certificate** menu in the left navigation bar.
 6. Click **Import Certificate and Private Key**.
 7. Browse to the file you want to import.
 8. Type the password if the file is encrypted, and then click **Submit**.

The self-signed certificate is imported to your machine.

To use SSL/TLS communication, the self-signed certificate must also be installed on your computer. For more information, contact your network administrator.



Related Information

- [Import and Export the Self-signed Certificate on your Brother Machine](#)

Related Topics:

- [Check the IP Address of Network Devices](#)

Export the Self-signed Certificate

Related Models: DSmobile DS-940DW

1. Start your web browser.
2. Do one of the following:
 - When using Wireless Direct
Type "https://192.168.118.1" in your browser's address bar.
 - When using infrastructure mode
Type "https://machine's IP address" in your browser's address bar (where "machine's IP address" is the machine's IP address).
For example:
https://192.168.1.2

If the machine prompts you for a password, type it, and then click . If you have not previously set your own password, type the default login password. The default password for managing machine settings is either:

- the password located on the bottom of the machine and preceded by "**Pwd**".
 - **initpass**
3. Click the **Network** tab.
 4. Click the **Security** tab.
 5. Click the **Certificate** menu in the left navigation bar.
 6. Click **Export** shown with **Certificate List**.
 7. If you want to encrypt the file, type a password in the **Enter password** field.
If the **Enter password** field is blank, your output file will not be encrypted.
 8. Type the password again in the **Retype password** field, and then click **Submit**.
 9. Click **Save**.

The self-signed certificate is exported to your computer.

You can also import the self-signed certificate to your computer.



Related Information

- [Import and Export the Self-signed Certificate on your Brother Machine](#)

Related Topics:

- [Check the IP Address of Network Devices](#)

Brother iPrint&Scan for Windows and Mac

- [Brother iPrint&Scan Overview](#)

Brother iPrint&Scan Overview

Use Brother iPrint&Scan for Windows and Mac to scan from your computer.

The following screen shows an example of Brother iPrint&Scan for Windows. You can use it to scan documents and check your machine's status. The actual screen may differ depending on the version of the application.

- Windows
Go to your model's **Downloads** page at support.brother.com to download the latest application.
- Mac
Download and install Brother iPrint&Scan from the App Store.

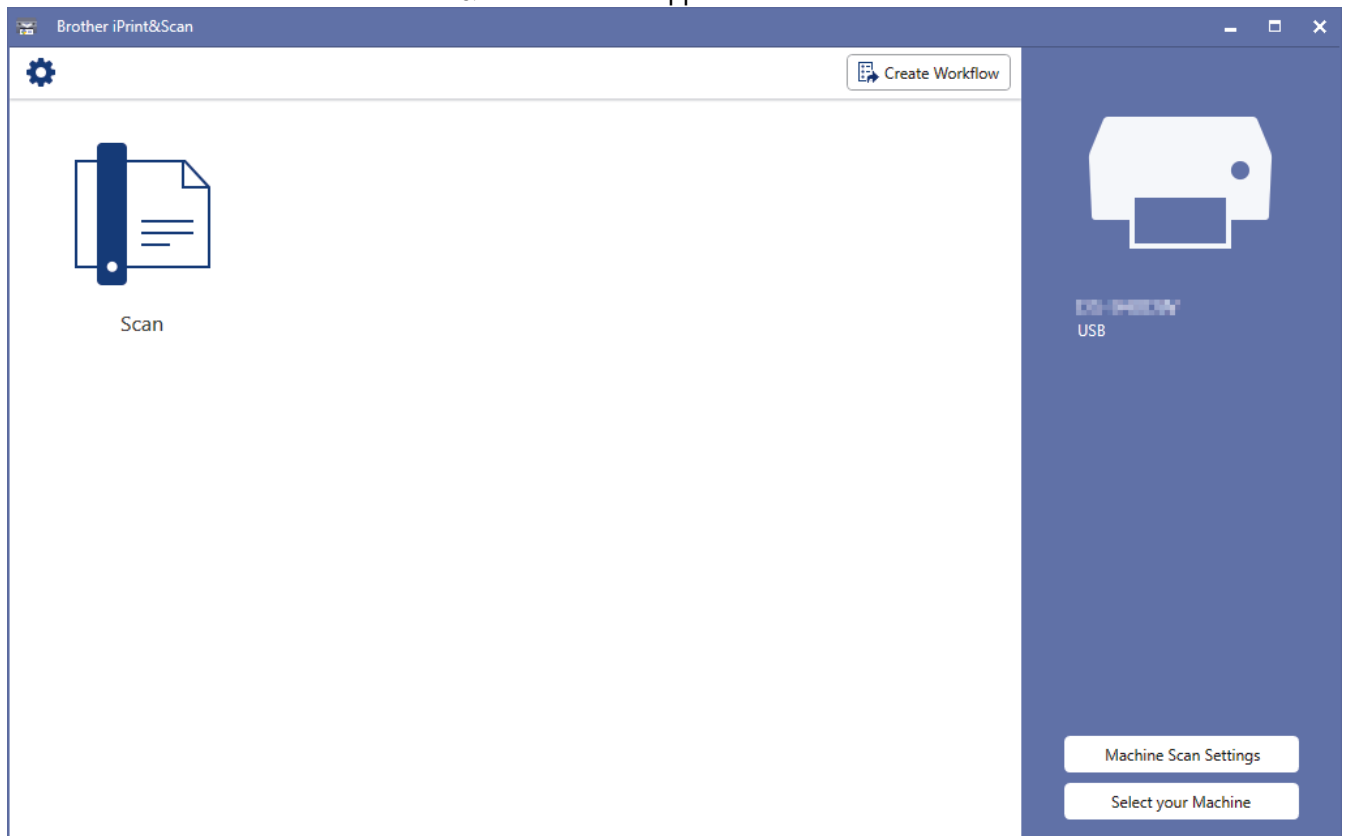

✓ Related Information

- [Brother iPrint&Scan for Windows and Mac](#)

Related Topics:

- [Scan Using Brother iPrint&Scan \(Windows\)](#)
- [Scan Using Brother iPrint&Scan \(Mac\)](#)

Troubleshooting





- [Error and Maintenance Indications](#)
- [Document Jam](#)
- [If You Are Having Difficulty with Your Machine](#)
- [Check the Serial Number](#)
- [Reset Your Brother Machine](#)



Error and Maintenance Indications

>> DSmobile DS-640/DSmobile DS-740D
 >> DSmobile DS-940DW

DSmobile DS-640/DSmobile DS-740D





The LED indications on the control panel are explained in this table.











Power/Scan LED	Description
	The LED is off.
 	The LED is lit in the colour shown.
 	The LED is blinking in the colour shown.





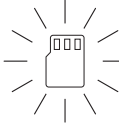











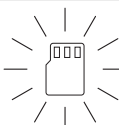













Power/Scan LED	Machine Status
	<p>Document Jam Clear the document jam. If scanning a long document, select Long Paper from the Scan Size or Document Size drop-down list. When inserting an embossed card, make sure to insert it embossed side up into the Feeder Slot.</p>
	<p>Top Cover Open The Top Cover is open. Close the Top Cover.</p>
	<p>Insufficient Storage Space When using the Scan to PC function, there may not be enough memory in the destination folder for the scanned data. Press START/STOP to clear the error. Make sure that there is enough space in the destination folder to save the scanned data.</p>
 ↔ 	<p>Updating the Firmware Firmware update in progress. Wait for the update to complete.</p>











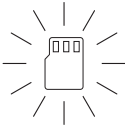

DSmobile DS-940DW

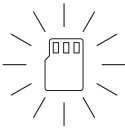
The LED indications on the control panel are explained in this table.

Error LED	SD Card LED	Wi-Fi LED	Battery LED	Power/Scan LED	Description
					The LED is off.

Error LED	SD Card LED	Wi-Fi LED	Battery LED	Power/ Scan LED	Description
					The LED is lit in the colour shown.
					The LED is blinking in the colour shown.
					The LED can be off, lit, or blinking in any colour.

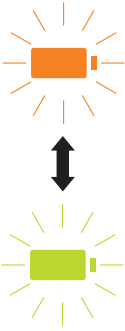
Error LED	SD Card LED	Wi-Fi LED	Battery LED	Power/ Scan LED	Machine Status
					<p>Document Jam Clear the document jam. If scanning a long document, select Long Paper from the Scan Size or Document Size drop-down list. When inserting an embossed card, make sure to insert it embossed side up into the Feeder Slot.</p> <p>Top Cover Open The Top Cover is open. Close the Top Cover.</p>
					<p>Updating the Firmware Firmware update in progress. Wait for the update to complete.</p>
					<p>Insufficient Storage Space When using the Scan to PC function, there may not be enough memory in the destination folder for the scanned data. Press START/STOP to clear the error. Make sure that there is enough space in the destination folder to save the scanned data.</p>
					<p>Access Error Scan to PC The USB cable is not connected to the machine. Connect the USB cable.</p>
					<p>Access Error Scan to PC The Scan to PC settings were not configured in Remote Setup. Configure the Scan to PC settings in Remote Setup.</p>
		 (blinking slowly)			<p>Wireless Network Connection Error Press START/STOP to clear the error. Confirm the network settings.</p>

Error LED	SD Card LED	Wi-Fi LED	Battery LED	Power/ Scan LED	Machine Status
 (blinking slowly)	 (blinking rapidly)				Unsupported Memory Card An unsupported memory card is inserted into the Memory Card Slot. <ul style="list-style-type: none"> Remove the memory card and insert the supported microSD memory card. Format the microSD memory card on the computer.
 (blinking rapidly)	 (blinking rapidly)				Too Many Files on the Memory Card Your machine cannot save files to a memory card if the card contains too many files. Press START/STOP to clear the error. Remove the microSD memory card, and then do one of the following: <ul style="list-style-type: none"> Delete unused files or folders from the microSD memory card, and then try again. Use a microSD memory card that has available space.
					Battery Error Battery error has occurred. <ul style="list-style-type: none"> The internal temperature of the machine or of its battery is too high or too low. Wait until the temperature returns to normal and the LED stops flashing. Turn the machine off, and then turn it on again. If it is not restored, contact your Brother dealer or Brother customer service. Connect the USB cable to your scanner and your computer to use the scanner. Make sure the USB cable is securely connected. If the error cannot be cleared, contact your local Brother office. <i>See Related Information: Brother Help and Customer Support.</i>

✓ Related Information

- [Troubleshooting](#)
 - [Service Call Indications](#)

Related Topics:

- [Document Jam](#)
- [Brother iPrint&Scan for Windows and Mac](#)
- [Brother Help and Customer Support](#)

Service Call Indications

If there is an error that you cannot clear yourself, the machine's LEDs will indicate the need for a service call as shown.

If you see the service call indication shown, contact your Brother dealer or Brother customer service.



>> [DSmobile DS-640/DSmobile DS-740D](#)

>> [DSmobile DS-940DW](#)

DSmobile DS-640/DSmobile DS-740D

Power/Scan LED
 (blinking rapidly)

DSmobile DS-940DW

Error LED	SD Card LED	Wi-Fi LED	Battery LED	Power/Scan LED
 (blinking rapidly)				

✓ Related Information

- [Error and Maintenance Indications](#)

Document Jam

A document can jam if it is not inserted or fed correctly, or if it is too long.

1. (DSmobile DS-740D/DSmobile DS-940DW) Open the Output Guide.

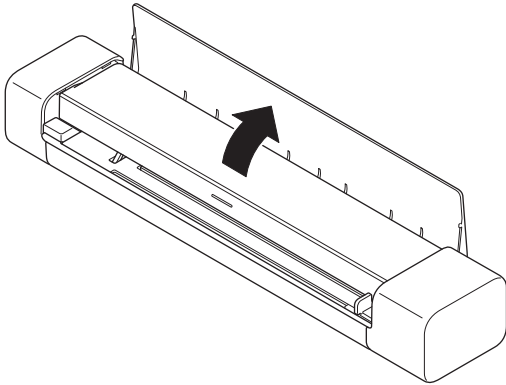

2. Open the Top Cover.

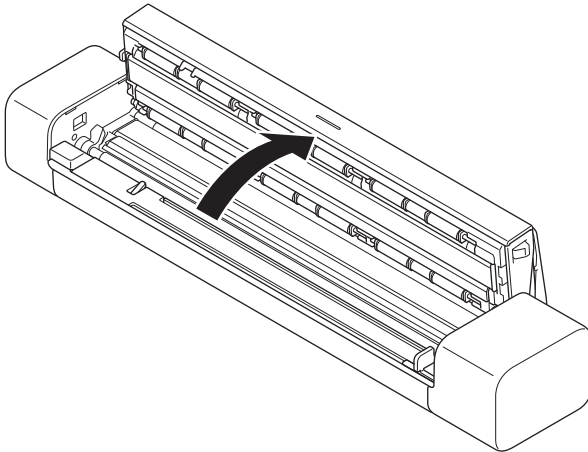

3. Gently pull the jammed document out of the machine.

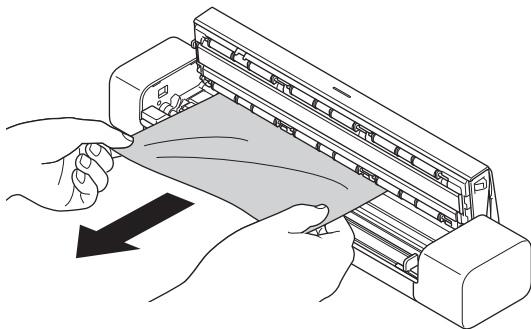

Check for ripped paper inside the machine. Remove any paper scraps you find inside the machine.

4. Close the Top Cover.
5. (DSmobile DS-740D/DSmobile DS-940DW) Close the Output Guide.

IMPORTANT

- To avoid damage to the jammed document, DO NOT pull the document out before opening the Top Cover.

-
- To avoid future document jams, do the following:
 - Close the Top Cover correctly by pushing it gently in the centre.
 - Configure the settings for your document correctly.
 - Make sure your document is acceptable for the machine.
 - Load your document correctly.
 - When using long paper, to avoid a paper jam, you must select the **Long Paper** option from the **Document Size** menu.
-



Related Information

- [Troubleshooting](#)

Related Topics:

- [Error and Maintenance Indications](#)
 - [Acceptable Documents](#)
 - [Load Documents](#)
-

If You Are Having Difficulty with Your Machine

You can correct most problems yourself. If you think there is a problem with your machine, check the topics below. If you need additional help, visit support.brother.com for the latest **FAQs & Troubleshooting** tips.



Using non-Brother supplies may affect the scan quality, hardware performance, and machine reliability.

- [Scanning and Other Problems](#)
- [AirPrint Scanning Problems](#)
- [Network Problems](#)



Scanning and Other Problems

- >> Scanning Difficulties
- >> Software Difficulties
- >> Other Difficulties

Scanning Difficulties



Difficulties	Cause	Suggestions
TWAIN or WIA errors appear when starting to scan. (Windows)	The TWAIN or WIA driver has not been selected as the primary source in your scanning application.	Make sure the Brother TWAIN or WIA driver is selected as the primary source in your scanning application. For example, in Nuance™ PaperPort™ 14SE, click Scan Settings > Select . Select the Brother TWAIN/WIA driver.
ICA errors appear when starting to scan. (Mac)	The machine is not selected from the DEVICES area or SHARED area.	Make sure your Brother machine is selected.
Vertical lines are seen in the scanned image.	Paper dust has accumulated on the surface of the glass strips.	Clean the glass strips inside the machine. <i>See Related Information: Clean the Scanner and Rollers.</i>
White vertical lines or white strips appear on the scanned image. 	The scanner is near a light source or in direct sunlight.	Make sure the scanner is located away from any direct light sources.
My scanned images have black lines running through them, blank spaces, or are of overall poor quality.	This problem occurs if the scanner is not calibrated correctly or if a foreign object, such as a paper clip or ripped paper, is stuck in the scanner.	<ol style="list-style-type: none"> 1. Make sure that the Feeder Slot is clear. If foreign objects are found, remove them from your scanner. 2. Calibrate your scanner. If scan quality is not improved after you calibrate your scanner: <ol style="list-style-type: none"> 1. Clean the scanner. 2. Calibrate your scanner again. <i>See Related Information: Clean the Scanner and Rollers.</i> <i>See Related Information: Calibrate Your Brother Machine.</i>
The scanned image is missing.	The Document Guide is not adjusted to fit the width of the document.	Gently adjust the Document Guide to fit the width of your document.
	The settings are not appropriate for your document. For example, a Letter/A4-sized document was fed when Executive/A5 Letter was selected as the document size.	Make sure the document size settings are appropriate for your document. Configure the margin settings and adjust the scanning position.
	-	Configure the margin settings and adjust the scanning position.

Difficulties	Cause	Suggestions
The scanned image is missing or has blank spaces when Auto is selected as the document size.	Paper dust has accumulated on the surface of the glass strips inside the machine.	Clean the glass strips inside the machine. <i>See Related Information: Clean the Scanner and Rollers.</i>
	Calibration needs to be performed.	Perform the calibration. <i>See Related Information: Calibrate Your Brother Machine.</i>
The scanned image is skewed.	The Document Guide is not adjusted to fit the width of the document.	Gently adjust the Document Guide to fit the width of your document.
	The Long Paper setting is selected.	Select a setting other than Long Paper.
	The document was curled.	Straighten the curled document and scan again.
	The embossed card was inserted with the embossed side down.	Remove the embossed card and then reinsert it, embossed side up, into the Feeder Slot.
	The document is not inserted straight.	Insert the document straight.
	The plastic card is scanned with the short edge first.	Scan the plastic card with the long edge first.
	The Output Guide is open. (DSmobile DS-740D/ DSmobile DS-940DW)	Close the Output Guide.
Scanning is too slow.	The resolution is not appropriate for your document.	Decrease the scanner resolution.
	If a cable other than a Micro USB 3.0 cable is used, the scanning speed may become slow.	Use Micro USB 3.0 cable.
The document was not fed.	Your media is too thin or too thick.	Make sure your media is acceptable for the machine. <i>See Related Information: Acceptable Documents.</i>
	Remote Setup is in progress.	Cancel Remote Setup.
	The document was curled.	Straighten the curled document and scan again.
The document is jammed.	Your document is not acceptable for the machine.	Make sure your document is acceptable for the machine. <i>See Related Information: Acceptable Documents.</i>
	The document was curled.	Straighten the curled document and scan again.
	The Output Guide is open. (DSmobile DS-740D/ DSmobile DS-940DW)	Close the Output Guide. Confirm the paper weight is appropriate for scanning with the Output Guide. <i>See Related Information: Acceptable Documents.</i>
The scan quality is poor.	Paper dust has accumulated on the surface of the glass strips inside the machine.	Clean the glass strips inside the machine. <i>See Related Information: Clean the Scanner and Rollers.</i>
	Calibration needs to be performed.	Perform the calibration.

Difficulties	Cause	Suggestions
The scan quality is poor.		See <i>Related Information: Calibrate Your Brother Machine</i> .
	The scanner resolution is too low.	Increase the scanner resolution.
Bleedthrough is seen in the scanned data.	The settings are not appropriate for the type of document being scanned.	Select the Remove Bleed-through / Pattern / Remove Background Colour check box.
Colours in the scanned data are dark.	The settings are not appropriate for the type of document being scanned.	Do one of the following: <ul style="list-style-type: none"> Select the Remove Bleed-through / Pattern / Remove Background Colour check box, and then scan from your computer. Increase the Brightness, and then scan from your computer. Increase the Contrast, and then scan from your computer. Change the Scan Type to Grey or Colour, and then scan from your computer.
	Calibration needs to be performed.	Perform the calibration. See <i>Related Information: Calibrate Your Brother Machine</i> .
A page that is not a blank page is skipped.	<ul style="list-style-type: none"> The document is too faint. Skip Blank Page is set to On. 	Set Skip Blank Page to Off. Alternatively, reduce the Skip Blank Page sensitivity.
Cannot scan a long document.	Long Paper is not selected for the document size.	Select Long Paper for the document size.
Cannot scan. (DSmobile DS-940DW)	The Pull Scan option in the Scan from PC dialog box in Web Based Management is disabled.	Enable the Pull Scan option.
Cannot scan to a computer from the machine.	Scanning application (for example, Brother iPrint&Scan) is not installed on the computer.	Install a scanning application (for example, Brother iPrint&Scan). See <i>Related Information: Brother iPrint&Scan for Windows and Mac</i> .
	The settings are not configured within the scanning application (for example, Brother iPrint&Scan).	Configure the settings using a scanning application (for example, Brother iPrint&Scan). See <i>Related Information: Brother iPrint&Scan for Windows and Mac</i> .
	The Scan to PC settings were not configured in Remote Setup.	Configure the Scan to PC settings in Remote Setup.
	The Mode Select Switch is set to  . (DSmobile DS-940DW)	Set the Mode Select Switch to  or  .
The plastic card is jammed.	The machine was turned on with the plastic card inserted.	Remove the plastic card. To prevent the card from getting jammed again, do not leave the card inserted in the machine.
	The embossed card was inserted with the embossed side down.	Remove the embossed card and then reinsert it, embossed side up, into the Feeder Slot.
	The plastic card is not inserted straight.	Insert the plastic card straight.
	The Output Guide is open.	Close the Output Guide.







Difficulties	Cause	Suggestions
The plastic card is jammed.	(DSmobile DS-740D/ DSmobile DS-940DW)	
The plastic card was not fed.	The embossed card was inserted with the embossed side down.	Remove the embossed card and then reinsert it, embossed side up, into the Feeder Slot.

Software Difficulties

Difficulties	Cause	Suggestions
Cannot save the settings in Remote Setup or Web Based Management.	The machine is processing the settings.	Wait until the machine finishes processing, and then try again.
Cannot start Remote Setup.	The machine is not connected to your computer.	Connect the machine to your computer, and then try again.
	An error is occurring.	Clear all errors, check the status is Ready on Remote Setup and then try again.
	The machine is scanning.	Wait until scanning has finished and try again.
	The machine is turned off. (DSmobile DS-940DW)	Turn the machine on, and then try again.
	The Mode Select Switch is set to  . (DSmobile DS-940DW)	Set the Mode Select Switch to  or  .

Other Difficulties

Difficulties	Cause	Suggestions
I want to use a USB hub.	A USB hub may not be able to supply enough power to the scanner.	Use your scanner without connecting it to a USB hub.
The machine is not turned on.	The USB cable is not connected correctly.	Make sure the USB cable is securely connected to your scanner and computer.
	The battery is low. (DSmobile DS-940DW)	Connect the USB cable to your scanner and computer to charge the battery. You must charge the battery sufficiently for the scanner to turn on. Turn the scanner off until the battery is fully charged.
Your computer cannot find the machine via USB interface.	The scanner driver is not installed.	Install the scanner driver.
	The USB cable is not connected correctly.	Make sure the USB cable is securely connected to your scanner and computer. Disconnect the USB cable and then reconnect it to your scanner and computer.
My scanner gets warm.	It is normal for your scanner to become warm after prolonged use.	If there is an odour coming from the scanner or the scanner feels a little bit hot to the touch, immediately disconnect the USB cable from your scanner and computer.
My scanner cannot be turned on or turns off immediately. (DSmobile DS-940DW)	<ul style="list-style-type: none"> The battery has no remaining power. The battery is low. 	Do one of the following: <ul style="list-style-type: none"> Connect the USB cable to your scanner and your computer to use the scanner. If you cannot turn the scanner on when

Difficulties	Cause	Suggestions
My scanner cannot be turned on or turns off immediately. (DSmobile DS-940DW)		<p>you press , wait for two minutes, and then press  again.</p> <ul style="list-style-type: none"> • Turn the scanner off and connect the USB cable to your scanner and your computer until the battery is fully charged. Try to scan again. • Make sure the USB cable is securely connected to your scanner and computer. • If the error cannot be cleared, contact your local Brother office. <p><i>See Related Information: Brother Help and Customer Support.</i></p>
	The internal temperature of the machine or its battery is either too high or too low. (DSmobile DS-940DW)	The machine will be automatically restored when the temperature returns to normal.
When I set the Mode Select Switch to  , the Wi-Fi LED does not turn on. (DSmobile DS-940DW)	The battery is low.	<ul style="list-style-type: none"> • Connect the USB cable to your scanner and your computer to charge the battery. • Make sure the USB cable is securely connected to your scanner and computer. • If the error cannot be cleared, contact your local Brother office. <p><i>See Related Information: Brother Help and Customer Support.</i></p>
I cannot charge the battery. (DSmobile DS-940DW)	-	<ul style="list-style-type: none"> • Make sure the USB cable is securely connected to your scanner and computer. • If the error cannot be cleared, contact your local Brother office. <p><i>See Related Information: Brother Help and Customer Support.</i></p>
My computer cannot access the machine's microSD memory card via the USB cable. (DSmobile DS-940DW)	The USB cable is not connected to your computer.	Connect the USB cable to your scanner and your computer.
	The Mode Select Switch is set to  or  . (DSmobile DS-940DW)	Set the Mode Select Switch to  .
	A document is being scanned. (DSmobile DS-940DW)	When the scanning is finished, wait for the memory card's folder to appear on your computer screen.
When I access the machine's memory card, scanned images are not displayed on the screen. (DSmobile DS-940DW)	Your scanner is not in mass storage mode.	Set the mode select switch to  to change to mass storage mode.
	Your scanner is scanning a document. (DSmobile DS-940DW)	Access the memory card again when scanning is complete.
The machine cannot update the firmware due to the battery error. (DSmobile DS-940DW)	The internal temperature of the machine or its battery is either too high or too low.	Wait until the temperature returns to normal, and then try again.



Related Information





- [If You Are Having Difficulty with Your Machine](#)

Related Topics:

- [Clean the Scanner and Rollers](#)
 - [Acceptable Documents](#)
 - [Brother iPrint&Scan for Windows and Mac](#)
 - [Calibrate Your Brother Machine](#)
 - [Brother Help and Customer Support](#)
-

AirPrint Scanning Problems

Related Models: DSmobile DS-940DW

Difficulty	Suggestions
My Brother machine is not displayed in the scanner list.	Make sure your Brother machine is turned on.
	Make sure your machine and your Mac are correctly connected to the same network.
	Set the Mode Select Switch to  or  .
I cannot scan.	Make sure your Brother machine is turned on.
	Make sure your machine and your Mac are correctly connected to the same network.
	Set the Mode Select Switch to  or  .
	Make sure the scan feature is enabled from Network > Protocol > AirPrint Scanning in Web Based Management.



Related Information

- [If You Are Having Difficulty with Your Machine](#)

Related Topics:

- [Access Web Based Management](#)

Network Problems

Related Models: DSmobile DS-940DW

- [If You Cannot Complete the Wireless Network Setup Configuration](#)
- [Your Scanner Cannot Be Detected on the Network During Installation](#)
- [Your Brother Machine Cannot Scan over the Network](#)
- [If You Want to Check that Your Network Devices are Working Correctly](#)

If You Cannot Complete the Wireless Network Setup Configuration

Related Models: DSmobile DS-940DW

Turn your wireless router off and back on. If that does not resolve the problem, try to configure the wireless settings again. If this still does not resolve the problem, use the Actions listed in this table.

Cause	Action	Interface
Your security settings (SSID/ Network Key (Password)) are not correct.	<p>Confirm your security settings.</p> <ul style="list-style-type: none"> The manufacturer's name or model number of the wireless access point/router may be used as the default security settings. See the instructions supplied with your wireless access point/router for information on how to find the security settings. Ask the manufacturer of your wireless access point/router, your Internet provider, or your network administrator. 	Wireless
Your Brother machine's MAC address is not allowed.	Confirm that the Brother machine's MAC Address is allowed in the filter. The address is printed on your product label.	Wireless
Your wireless access point/router is in stealth mode (not broadcasting the SSID).	<ul style="list-style-type: none"> Enter the correct Network Name (SSID) and Network Key (Password) manually. Check the Network Name (SSID) and Network Key (Password) in the instructions supplied with your wireless access point/router and reconfigure the wireless network setup. 	Wireless
Your security settings (SSID/ Password) are not correct.	<p>Confirm the Network Name (SSID) and Network Key (Password). The SSID and Network Key are printed on the label attached to the scanner.</p>	Wireless Direct
Your Brother machine is placed too far from your wireless device.	Move your Brother machine within about 1 metre of the wireless device when you configure the Wireless Direct network settings.	Wireless Direct
There are some obstructions (walls or furniture, for example) between your machine and the wireless device.	Move your Brother machine to an obstruction-free area.	Wireless Direct
There is a wireless computer, Bluetooth®-supported device, microwave oven, or digital cordless phone near the Brother machine or the wireless device.	Move other devices away from the Brother machine or the wireless device.	Wireless Direct
If you have checked and tried all of the actions, but still cannot complete the Wireless Direct configuration.	Turn your Brother machine off and back on. Then try to configure the Wireless Direct settings again.	Wireless Direct



Related Information

- [Network Problems](#)

Your Scanner Cannot Be Detected on the Network During Installation

Related Models: DSmobile DS-940DW

Cause	Action
Your computer is not connected to the network.	Make sure your computer is connected to a network, for example, a Wireless LAN environment or has Internet access. For further support, contact your network administrator.
Your machine is not connected to the network.	If the Error LED on the Control Panel blinks in orange, it indicates an error status. Make a note of the error status and then correct the error. <i>See Related Information: Error and Maintenance Indications.</i>
You use security software.	<ul style="list-style-type: none"> • In the installer dialog box, search for the Brother machine again. • Allow access when the alert message of the security software appears during the Brother Device installation. • The following port numbers are used for Brother network features: <ul style="list-style-type: none"> - Network scanning, Remote Setup Port number 5566/Protocol TCP - Network scanning (Brother iPrint&Scan) Port number 54921/Protocol TCP - BRAdmin Light Port number 161/Protocol UDP • For more information about security software, see <i>Related Information: Your Brother Machine Cannot Scan over the Network</i>.
The privacy separator on your Wi-Fi router is enabled.	Disable the privacy separator.
Your Brother machine is placed too far from the Wireless access point/router.	Place your Brother machine within about 1 metre of the Wireless access point/router when you configure the wireless network settings.
There are some obstructions (walls or furniture, for example) between your machine and the Wireless access point/router.	Move your Brother machine to an obstruction-free area, or closer to the Wireless access point/router.
There is a wireless computer, Bluetooth®-supported device, microwave oven, or digital cordless phone near the Brother machine or the Wireless access point/router.	Move all the devices away from the Brother machine or Wireless access point/router.



Related Information

- [Network Problems](#)

Related Topics:

- [Your Brother Machine Cannot Scan over the Network](#)
- [If You Want to Check that Your Network Devices are Working Correctly](#)
- [Error and Maintenance Indications](#)

Your Brother Machine Cannot Scan over the Network

Related Models: DSmobile DS-940DW

Cause	Action
You did not select Accept in the security alert dialog box during the Brother Device installation applications' start-up process, or when using the scanning features.	If you did not select Accept in the security alert dialog box, the firewall function of your security software may be denying access. Some security software may block access without showing a security alert dialog box. To allow access, see your security software instructions or ask the manufacturer.
Your security software blocks your machine's access to the network. (The Network scanning feature does not work.)	<ul style="list-style-type: none"> • Windows Configure the third-party Security/Firewall Software to allow Network scanning. To add port 54925 for Network scanning, type the information below: <ul style="list-style-type: none"> - in Name: Type any description, for example Brother NetScan. - in Port number: Type 54925. - in Protocol: UDP is selected. See the instruction manual that came with your third-party Security/Firewall Software or contact the software manufacturer. • Mac Reinstall the driver.
Your security software blocks your machine's access to the network.	The following port numbers are used for Brother network features: <ul style="list-style-type: none"> • Network scanning, Remote Setup Port number 5566/Protocol TCP • Network scanning (Brother iPrint&Scan) Port number 54921/Protocol TCP • BRAdmin Light Port number 161/Protocol UDP For information about how to open the port, see the security software instructions or ask the manufacturer.
Your Brother machine was not assigned an available IP address.	Confirm the IP address and the Subnet Mask. Verify that both the IP addresses and Subnet Masks of your computer and the Brother machine are correct and located on the same network. For more information about how to verify the IP address and the Subnet Mask, ask your network administrator. See <i>Related Information: Check the IP Address of Network Devices</i> .
You cannot connect the Brother machine to the network using wireless capabilities.	If the Error LED on the Control Panel blinks in orange, it indicates an error status. Make a note of the error status and then correct the error.

If you have checked and tried all of the actions, but your Brother machine still cannot scan, uninstall the Brother software and drivers and reinstall them.



Related Information

- [Network Problems](#)

Related Topics:

- [Your Scanner Cannot Be Detected on the Network During Installation](#)

-
- If You Want to Check that Your Network Devices are Working Correctly
 - Check the IP Address of Network Devices
 - Error and Maintenance Indications
-

If You Want to Check that Your Network Devices are Working Correctly

Related Models: DSmobile DS-940DW

Check	Action
Check that your Brother machine, access point/router, or network hub is turned on.	<p>Check the following:</p> <ul style="list-style-type: none"> Your Brother machine is connected to the computer using the USB cable correctly or the rechargeable Li-ion battery is charged enough, and the machine is turned on. The access point/router or hub is turned on and its connection status LED button is blinking. All protective packaging has been removed from the machine. The Top Cover is completely closed.
Check your Brother machine's network settings, such as IP address, or the connection status.	<ul style="list-style-type: none"> For Web Based Management Start Web Based Management and access your Brother machine. When the Web Based Management screen appears, click the Network tab, and then click Network Status in the left navigation bar. If the Error LED on the Control Panel blinks in orange, it indicates an error status. Make a note of the error status and then correct the error. <i>See Related Information: Error and Maintenance Indications.</i>
Check that you can "ping" the Brother machine from your computer.	<p>Ping the Brother machine from your computer using the IP address or the node name in the Windows command prompt or Mac Terminal application:</p> <pre>ping <ipaddress> or <nodename>.</pre> <ul style="list-style-type: none"> Successful: Your Brother machine is working correctly and connected to the same network as your computer. Unsuccessful: Your Brother machine is not connected to the same network as your computer. Confirm that the IP address and the Subnet Mask are set correctly.

If you have checked and tried all of the actions but you are still having problems, see the instructions supplied with your wireless access point/router to find the SSID and the Network Key (Password) information and set them correctly.

Related Information

- Network Problems
 - Check the IP Address of Network Devices

Related Topics:

- Your Brother Machine Cannot Scan over the Network
- Your Scanner Cannot Be Detected on the Network During Installation
- Error and Maintenance Indications

Check the IP Address of Network Devices

Related Models: DSmobile DS-940DW



Check the IP addresses of both your computer and your Brother machine, and then confirm whether the network is operating correctly.

>> [Configure the IP Address on your computer \(Windows\)](#)

>> [Configure the IP Address on your computer \(Mac\)](#)

>> [Configure the IP Address using Remote Setup](#)



Configure the IP Address on your computer (Windows)

1. Do one of the following:
 - Windows 10
Click  > **Windows System** > **Command Prompt**.
 - Windows 8.1
Move your mouse to the lower-right corner of your desktop. When the menu bar appears, click **Search** > **Command Prompt**.
 - Windows7
Click /(Start) > **All Programs** > **Accessories** > **Command Prompt**.
2. Type "ipconfig" and then press the Enter key on your keyboard.
3. Confirm the values for the IPv4 address and subnet mask.
4. Type "exit" and then press the Enter key on your keyboard.

Configure the IP Address on your computer (Mac)

1. Select **System Preferences** from the Apple menu.
2. Click **Network** > **Advanced** > **TCP/IP**.
3. Confirm the values for the IPv4 address and subnet mask.

Configure the IP Address using Remote Setup

1. Slide the Mode Select Switch to  or .
2. Do one of the following:
 - Windows
Click  **Brother Utilities** on your desktop, and then click the drop-down list and select your model name (if not already selected). Click **Tools** in the left navigation bar, and then click **Remote Setup**.
 - Mac
In the **Finder** menu bar, click **Go** > **Applications** > **Brother**, select your model name and then double-click the **Remote Setup** icon.



Type the password if required. If you have not previously set your own password, type the default login password.

The default login password is either:

- the password located on the bottom of the machine and preceded by "Pwd".
- **initpass**

3. Click the **WLAN** menu in the left navigation pane.



4. Confirm the IP address and subnet mask.



Related Information

- [If You Want to Check that Your Network Devices are Working Correctly](#)
-

Check the Serial Number

1. (DSmobile DS-940DW) Slide the Mode Select Switch to  or .

2. Do one of the following:

- Windows

Click  **Brother Utilities** on your desktop, and then click the drop-down list and select your model name (if not already selected). Click **Tools** in the left navigation bar, and then click **Remote Setup**.

- Mac

In the **Finder** menu bar, click **Go > Applications > Brother**, select your model name and then double-click the **Remote Setup** icon.



(DSmobile DS-940DW)

When your machine is connected via a Network, type the password if required. If you have not previously set your own password, type the default login password.

The default login password is either:

- the password located on the bottom of the machine and preceded by "Pw".
- **initpass**

3. Click the **Machine Info** menu in the left navigation pane.

The window displays the Serial Number (the example below uses Windows).

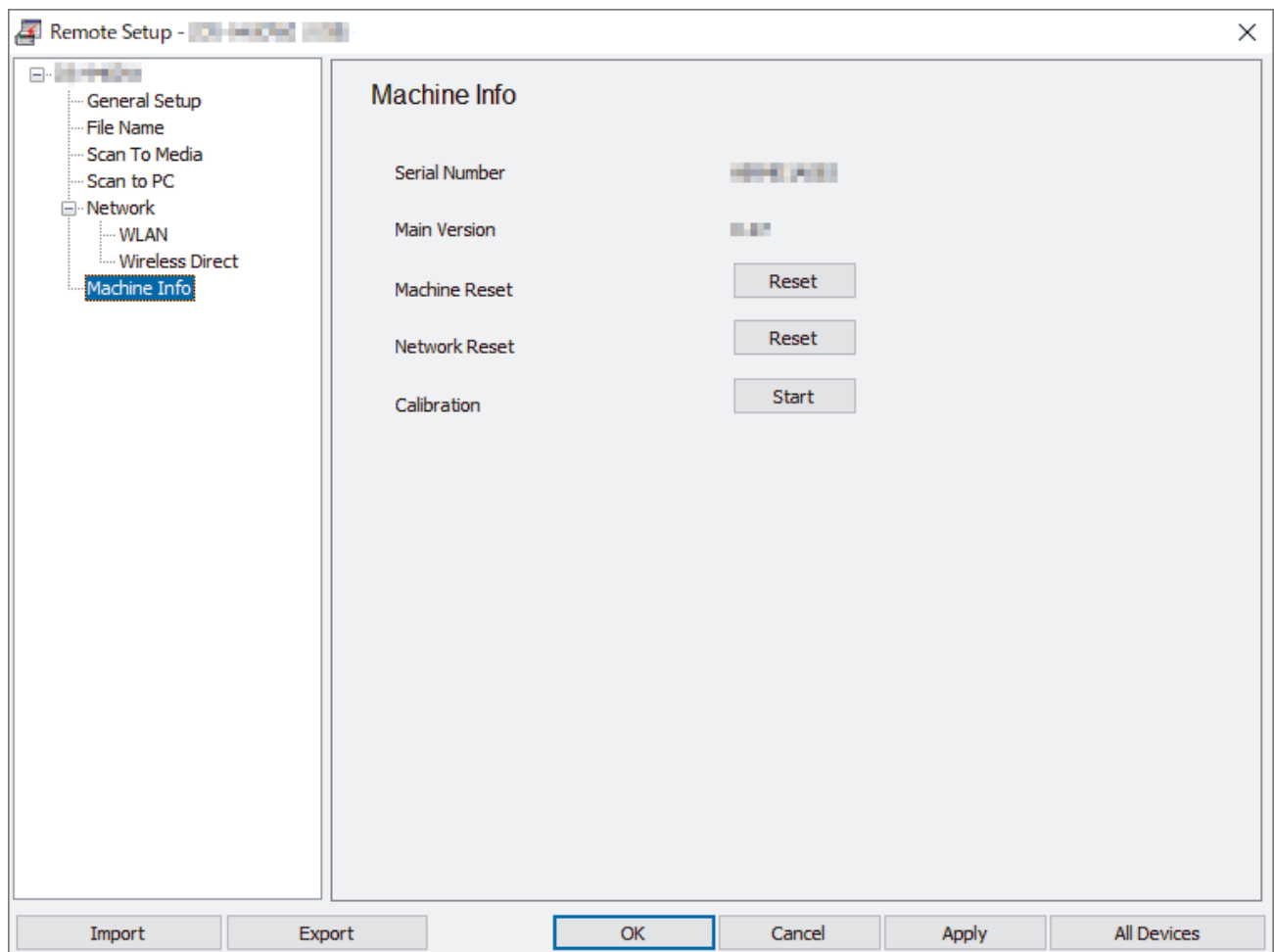

Related Information

- [Troubleshooting](#)

Reset Your Brother Machine

>> [Reset Network Settings on the Machine \(DSmobile DS-940DW\)](#)

>> [Reset Machine Settings using Remote Setup](#)

Reset Network Settings on the Machine (DSmobile DS-940DW)

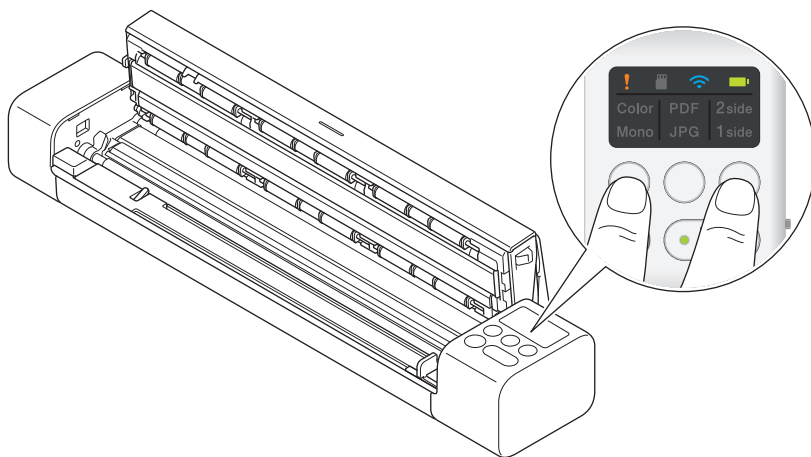

1. Confirm that the scanner is turned on.
2. Open the Output Guide.
3. Open the Top Cover.
4. Press and hold both the Colour/Mono Switching Button and the 2side/1side Switching Button for five seconds.



The Color/Mono, PDF/JPEG, and 2side/1side LED indicators light for one second. The network settings will be restored to the factory settings.

5. Close the Top Cover.
6. Close the Output Guide.

Reset Machine Settings using Remote Setup

1. (DSmobile DS-940DW) Slide the Mode Select Switch to  or .

2. Do one of the following:

- Windows

Click  **Brother Utilities** on your desktop, and then click the drop-down list and select your model name (if not already selected). Click **Tools** in the left navigation bar, and then click **Remote Setup**.

- Mac

In the **Finder** menu bar, click **Go > Applications > Brother**, select your model name and then double-click the **Remote Setup** icon.



(DSmobile DS-940DW)

When your machine is connected via a Network, type the password if required. If you have not previously set your own password, type the default login password.

The default login password is either:

- the password located on the bottom of the machine and preceded by "**Pwd**".
- **initpass**

3. Click the **Machine Info** menu in the left navigation pane.
4. Click the **Reset** button in the **Machine Reset** option.
5. Press **OK** to confirm.

The machine settings will be restored to the factory settings.

6. Click **OK** to close the Remote Setup window.



Related Information

- [Troubleshooting](#)
-

Routine Maintenance

- [Clean Your Brother Machine](#)
- [Calibrate Your Brother Machine](#)
- [Supplies](#)
- [Pack and Ship Your Brother Machine](#)
- [Remove and Dispose the Battery](#)

Clean Your Brother Machine

- [Clean the Outside of the Machine](#)
- [Clean the Scanner and Rollers](#)

Clean the Outside of the Machine

1. (DSmobile DS-940DW) Turn the machine off.
2. Disconnect the USB cable from both your scanner and your computer.
3. Wipe the outside of the scanner with a dry, soft, lint-free cloth to remove dust.

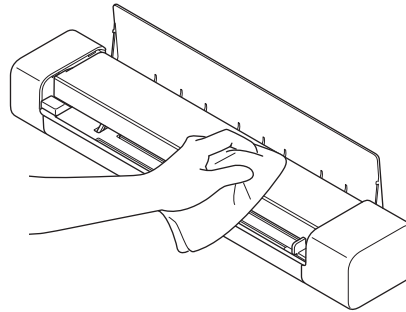
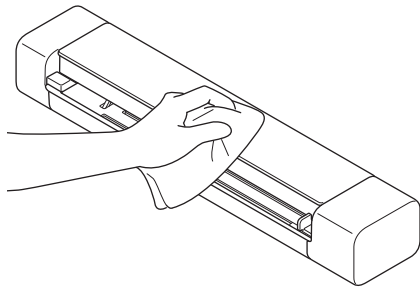

Wipe the outside of the machine first with a cloth lightly dampened with water or diluted detergent, and then with a dry cloth, if needed.

4. Reconnect the USB cable to your scanner and your computer.



Related Information

- [Clean Your Brother Machine](#)

Clean the Scanner and Rollers

A spot of dirt or correction fluid on the glass strip may cause poor quality scans. Clean the scanner and rollers if a vertical line appears in the scanned data or if areas are missing in the scanned data.

1. (DSmobile DS-940DW) Turn the machine off.
2. Disconnect the USB cable from both your scanner and your computer.
3. (DSmobile DS-740D/DSmobile DS-940DW) Open the Output Guide.

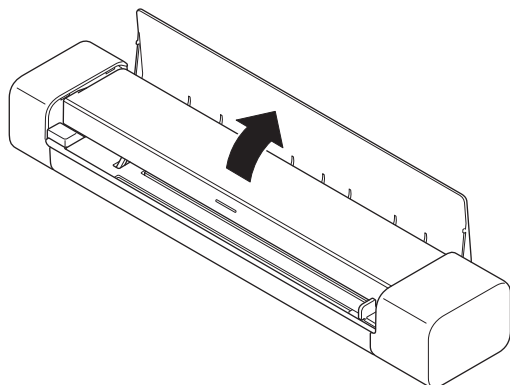

4. Open the Top Cover.

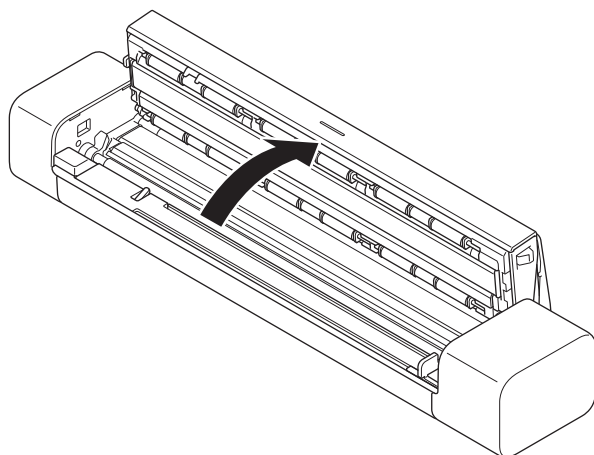

5. Gently wipe the glass strips and rollers with a dry, soft, lint-free cloth.

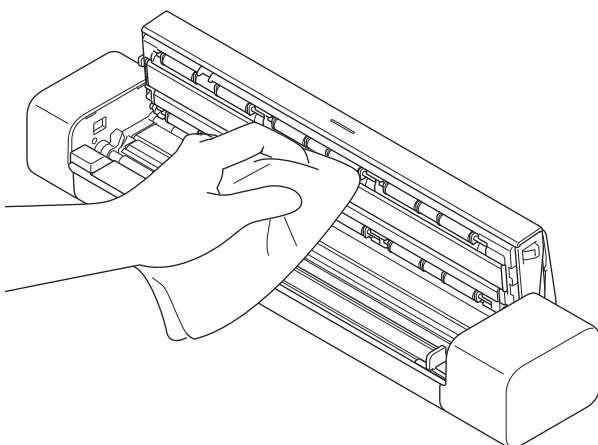

6. Close the Top Cover.
7. (DSmobile DS-740D/DSmobile DS-940DW) Close the Output Guide.
8. Reconnect the USB cable to your scanner and your computer.

✓ Related Information



- [Clean Your Brother Machine](#)

Related Topics:

- [Scanning and Other Problems](#)
-

Calibrate Your Brother Machine

Calibrate your scanner only if the scanned images start to look fuzzy, the colour looks abnormal (darker than normal), or if the scanner has been stored without being used for a long time.

1. (DSmobile DS-940DW) Slide the Mode Select Switch to  or .
2. Do one of the following:
 - Windows

Click  **Brother Utilities** on your desktop, and then click the drop-down list and select your model name (if not already selected). Click **Tools** in the left navigation bar, and then click **Remote Setup**.
 - Mac

In the **Finder** menu bar, click **Go > Applications > Brother**, select your model name and then double-click the **Remote Setup** icon.



(DSmobile DS-940DW)

When your machine is connected via a Network, type the password if required. If you have not previously set your own password, type the default login password.

The default login password is either:

- the password located on the bottom of the machine and preceded by "Pwd".
- **initpass**

3. Click the **Machine Info** menu in the left navigation pane.
4. Click the **Start** button in the **Calibration** option.
5. Click **OK**.
6. Hold the edges of the calibration sheet (supplied with the scanner) and insert it into the Feeder Slot as shown below.

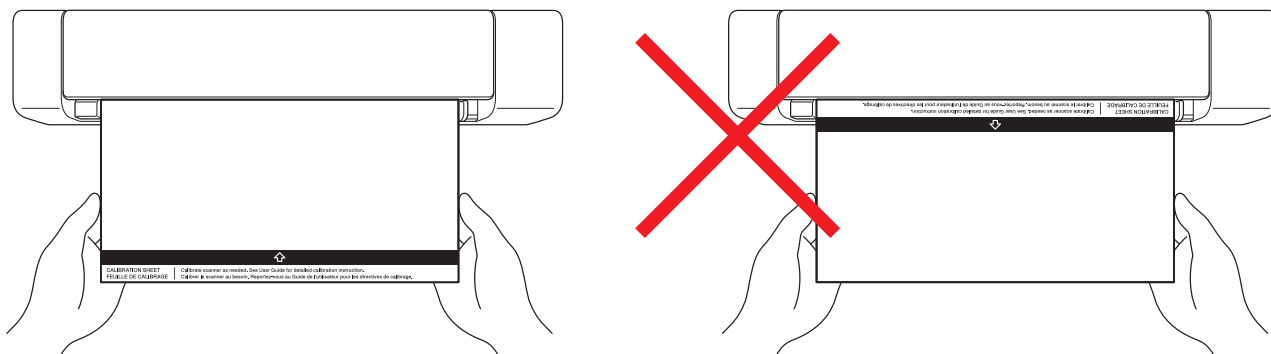

Hold only the edges of the calibration sheet and be careful not to touch the white or black areas. Leaving marks or fingerprints on this sheet can cause errors in calibration.

7. Click **OK** in the Remote Setup window.

The scanner starts feeding the calibration sheet, and then the calibration result appears on the computer screen.
8. When the Remote Setup displays a confirmation message, click **OK**.

If the calibration or scanning results are unsuccessful, try the following solutions:

Difficulties	Cause	Suggestions
Vertical line appears.	The environmental temperature has changed during calibration.	Make sure the temperature is the same during scanner use and recalibration.

Difficulties	Cause	Suggestions
	The scanner may have vibrated during calibration.	Place the scanner on a flat, stable surface and recalibrate.
	<ul style="list-style-type: none"> Dust on the paper path. Dust on the calibration sheet. 	<ul style="list-style-type: none"> Clean the paper path and try to scan again. Clean the paper path or calibration sheet. And then Recalibrate the scanner.
Vertical band appears.	<ul style="list-style-type: none"> Dust or fingerprint on the paper path. Dust, fingerprint, or scratch on the calibration sheet. 	<ul style="list-style-type: none"> Clean the paper path and try to scan again. Clean the paper path or use a new calibration sheet. And then recalibrate the scanner.
Colour is different from normal.	<ul style="list-style-type: none"> An incorrect calibration sheet is used. The temperature is too high or too low. There is a problem with the computer's USB port. 	<ul style="list-style-type: none"> Recalibrate the scanner using the correct calibration sheet. Recalibrate the scanner. Change to other USB port, and then recalibrate the scanner.
The calibration sheet is too short.	The calibration sheet has been cut or inserted incorrectly.	Recalibrate the scanner using the correct calibration sheet.



Related Information

- [Routine Maintenance](#)

Supplies

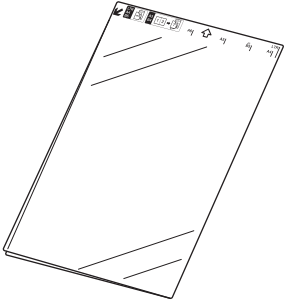
Part Name	Part No.	Standard Replacement Cycle
Carrier Sheet 	CS-A3401	500 times

✓ Related Information

- [Routine Maintenance](#)

Pack and Ship Your Brother Machine

When you transport the machine, use the packing materials that came with your machine. If you do not pack the machine correctly, any damage that may occur in transit may not be covered by your warranty.

The machine should be adequately insured with the carrier.

1. (DSmobile DS-740D/DSmobile DS-940DW) Close the Output Guide.
2. Wrap the machine in the original bag.

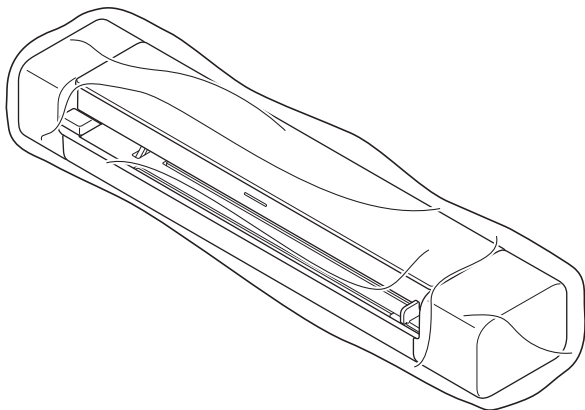

3. Pack the machine and the printed materials in the original carton with the original packing material as shown.

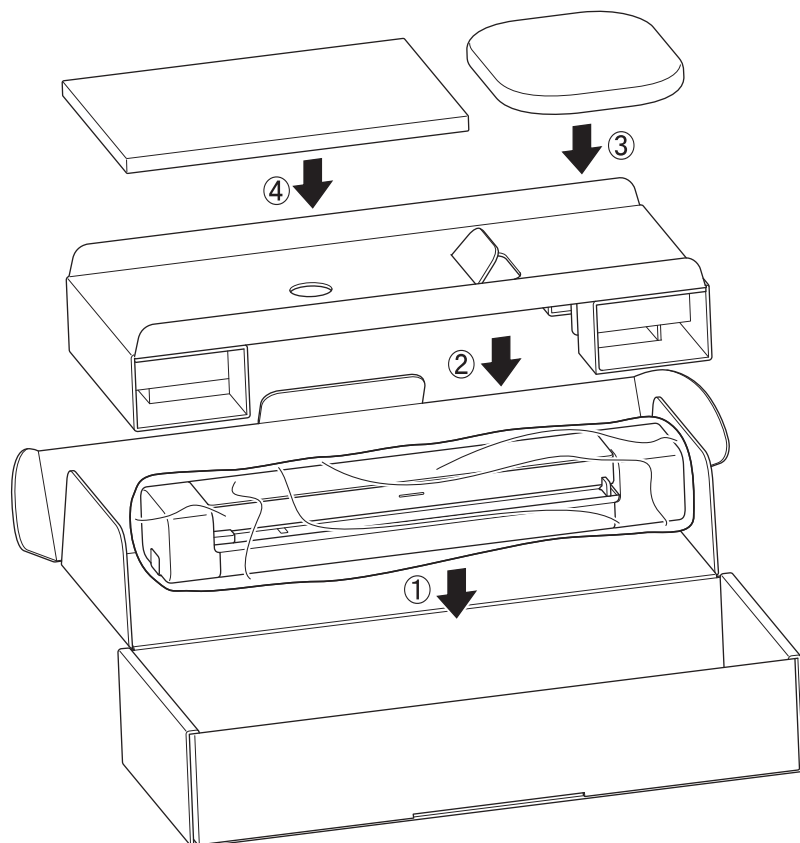

4. Close the carton and tape it shut.



Related Information

- [Routine Maintenance](#)

Remove and Dispose the Battery

Related Models: DSmobile DS-940DW

- We do not recommend removing the rechargeable Li-ion battery unless you are disposing of the machine.
- Before removing the battery, turn the machine off, and then disconnect the USB cable from the machine.

1. Place the machine face down on a flat surface and remove the Side Cover using a flathead screwdriver.

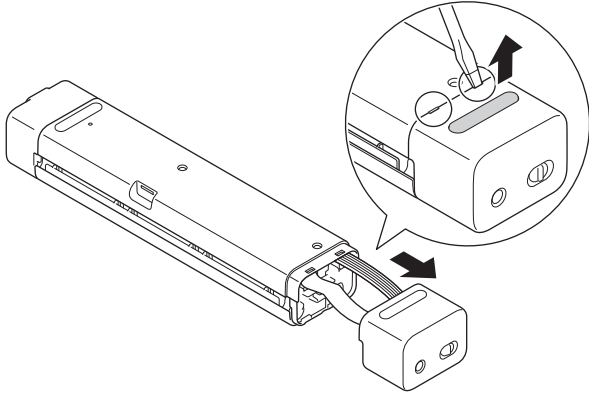

2. Disconnect the battery connector from the Printed Circuit Board Assembly (PCBA).

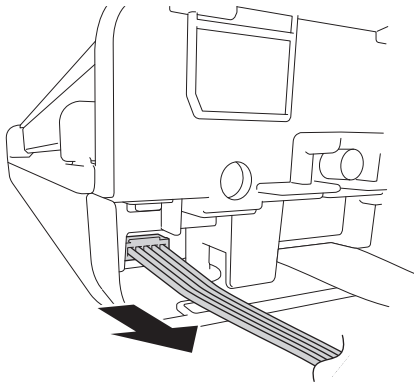

NOTE

Do not disconnect the Flexible Flat Cable (FFC).

3. Push the release tab (as illustrated) to remove the battery from the Side Cover.

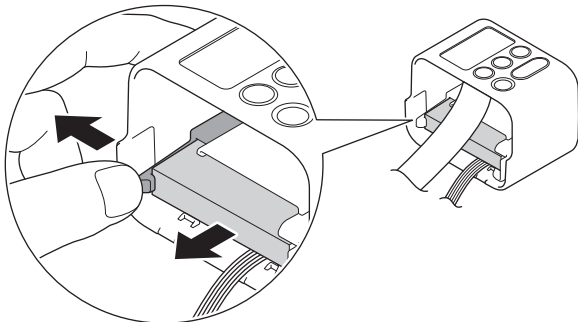

4. Cover the battery terminals with tape and dispose of it according to the applicable local regulations.

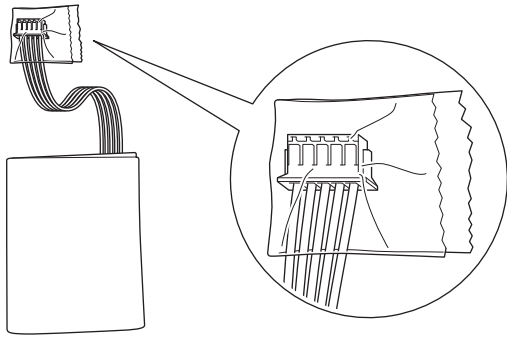

Related Information

- [Routine Maintenance](#)

Machine Settings

- [Change Machine Settings from Your Computer](#)

Change Machine Settings from Your Computer

- [Change Machine Settings Using Web Based Management](#)
- [Change the Machine Settings Using Remote Setup](#)

Change Machine Settings Using Web Based Management

Related Models: DSmobile DS-940DW

- [What is Web Based Management?](#)
- [Access Web Based Management](#)
- [Set or Change a Login Password for Web Based Management](#)

What is Web Based Management?

Related Models: DSmobile DS-940DW

Web Based Management is a utility that uses a standard web browser to manage your machine using the Hyper Text Transfer Protocol (HTTP) or Hyper Text Transfer Protocol over Secure Socket Layer (HTTPS).



- We recommend using Microsoft Internet Explorer 11 or later/Microsoft Edge for Windows, and Safari 12 or later for Mac. Make sure that JavaScript and Cookies are always enabled in whichever browser you use.
- You must use the TCP/IP protocol on your network and have a valid IP address registered to the scan server and your computer.

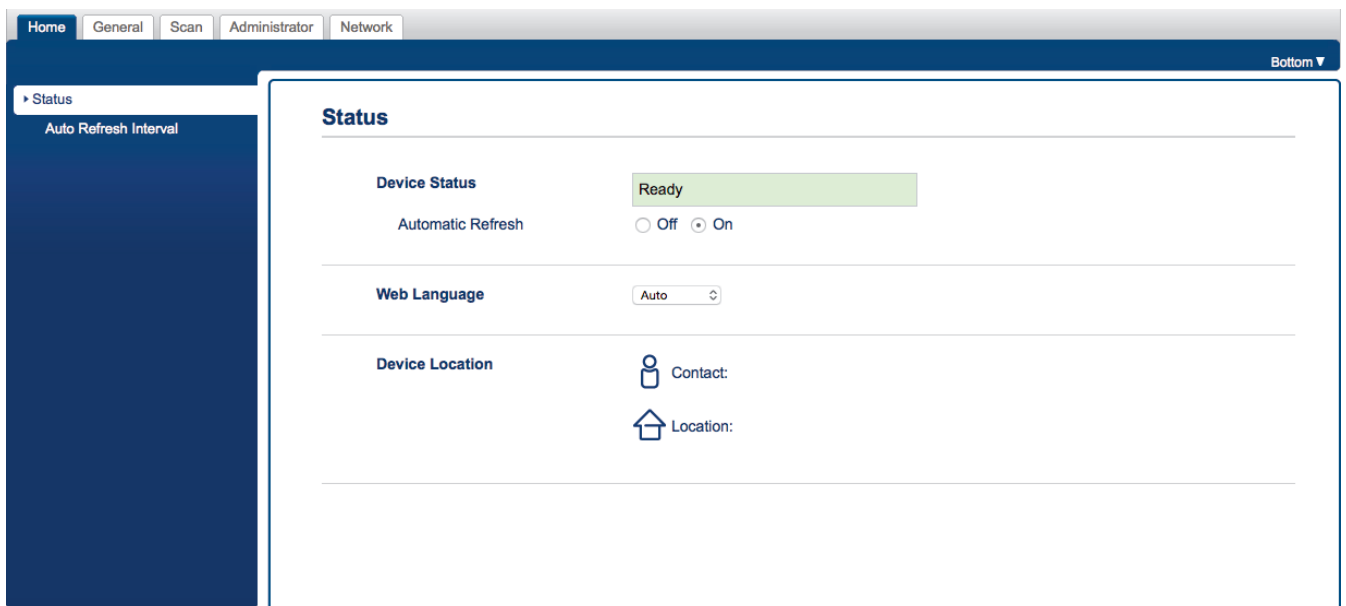

- Your screen may differ slightly from the screen shown.



Related Information

- [Change Machine Settings Using Web Based Management](#)

Access Web Based Management

Related Models: DSmobile DS-940DW

- We recommend using the HTTPS security protocol when configuring settings using Web Based Management.
- When you use HTTPS for Web Based Management configuration, your browser will display a warning dialog box. To avoid displaying the warning dialog box, you can install a self-signed certificate to use SSL/TLS communication. For more detailed information, see *Related Information*.
- The default password for managing machine settings is either:
 - the password located on the bottom of the machine and preceded by "Pwd".
 - **initpass**We recommend you change it to protect your machine from unauthorised access.

1. Start your web browser.
2. Do one of the following:
 - When using Wireless Direct
Type "https://192.168.118.1" in your browser's address bar.
 - When using infrastructure mode
Type "https://machine's IP address" in your browser's address bar (where "machine's IP address" is the machine's IP address).
For example:
https://192.168.1.2

If the machine prompts you for a password, type it, and then click . If you have not previously set your own password, type the default login password. The default password for managing machine settings is either:

- the password located on the bottom of the machine and preceded by "Pwd".
- **initpass**

You can now change your machine settings.



If the password is entered incorrectly three times, you will not be able to log in for three minutes.

IMPORTANT

If you change the protocol settings, you must restart the machine after clicking **Submit** to activate the new configuration.



Related Information

- [Change Machine Settings Using Web Based Management](#)



Related Topics:

- [Certificates and Web Based Management](#)
- [Create a Self-signed Certificate](#)
- [Install the Self-signed Certificate for Windows users with Administrator Rights](#)
- [Check the IP Address of Network Devices](#)

Set or Change a Login Password for Web Based Management

Related Models: DSmobile DS-940DW

We recommend changing the default login password to prevent unauthorised access to Web Based Management.

1. Start your web browser.
2. Do one of the following:
 - When using Wireless Direct
Type "https://192.168.118.1" in your browser's address bar.
 - When using infrastructure mode
Type "https://machine's IP address" in your browser's address bar (where "machine's IP address" is the machine's IP address).
For example:
https://192.168.1.2
3. Do one of the following:
 - If you have previously set your own password, type it, and then click .
 - If you have not previously set your own password, type the default login password and then click .
The default login password is either:
 - the password located on the bottom of the machine and preceded by "Pwd".
 - **initpass**
4. Click the **Administrator** tab.
5. Type the password you want to use in the **Enter New Password** field (8 to 32 characters).
6. Retype the password in the **Confirm New Password** field.
7. Click **Submit**.
8. After configuring the settings, click  to log off.



Related Information

- [Change Machine Settings Using Web Based Management](#)

Related Topics:

- [Check the IP Address of Network Devices](#)

Change the Machine Settings Using Remote Setup



The Remote Setup program lets you configure many of your Brother machine's settings from your computer. When you start Remote Setup, the settings on your Brother machine will be downloaded to your computer and displayed on your screen. If you change the settings on your computer, you can upload them directly to the machine.

- [Remote Setup \(Windows\)](#)
- [Remote Setup \(Mac\)](#)

Remote Setup (Windows)

- [Set Up the Brother Machine Using Remote Setup \(Windows\)](#)
- [Change the General Settings Using Remote Setup](#)

Set Up the Brother Machine Using Remote Setup (Windows)

1. (DSmobile DS-940DW) Slide the Mode Select Switch to  or .
2. Click  **Brother Utilities** on your desktop, and then click the drop-down list and select your model name (if not already selected). Click **Tools** in the left navigation bar, and then click **Remote Setup**.



(DSmobile DS-940DW)

When your machine is connected via a Network, type the password if required. If you have not previously set your own password, type the default login password.

The default login password is either:

- the password located on the bottom of the machine and preceded by "Pwd".
- **initpass**

3. Configure the settings as needed.

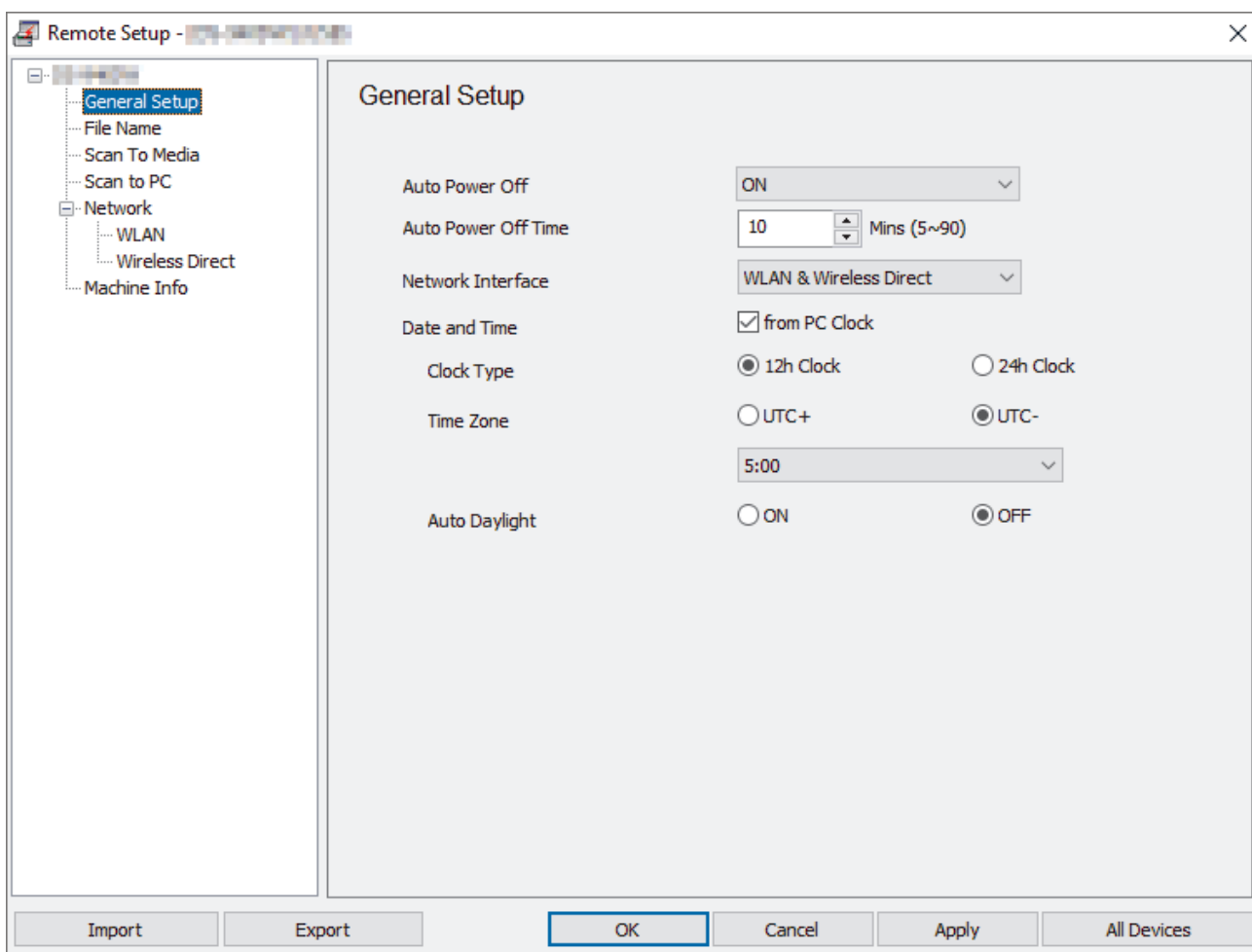

- Your screen may differ from the screen shown.
- (DSmobile DS-940DW) When the machine and computer are connected wirelessly, select **Scan to PC** in the navigation tree and configure scan settings to enable scanning from the **START/STOP** button on the machine.

Export

Click to save the current configuration settings to a file.

Import

Click to import a file and read its settings.

OK

Click to start uploading data to the machine, and then exit the Remote Setup Program. If an error message appears, confirm that your data is correct, and then click **OK**

Cancel

Click to exit the Remote Setup Program without uploading data to the machine.

Apply

Click to upload data to the machine without exiting the Remote Setup Program.



4. Click **OK**.

- If your computer is protected by a firewall and is unable to use Remote Setup, you may need to configure the firewall settings to allow communication through port numbers 52515-52614.
- If using Windows Firewall and you installed the scanner driver, the necessary firewall settings have already been set.

**Related Information**

- [Remote Setup \(Windows\)](#)

Change the General Settings Using Remote Setup

Purpose	Operation (Windows/Mac)	Description
Set the Date and Time (DSmobile DS-940DW)	General Setup > Date and Time	Set the date and time. If you set Auto Daylight to On, the time will be adjusted forward one hour in the spring and adjusted backward one hour in the autumn.
Set the Machine to Power Off Automatically	General Setup > Auto Power Off General Setup > Auto Power Off Time	<p>Select how long the machine must wait before it automatically turns itself off. The Auto Power Off feature can save power consumption.</p> <ul style="list-style-type: none"> (DSmobile DS-640/DSmobile DS-740D) To turn the machine on after the Auto Power Off feature has turned it off, press START/STOP. (DSmobile DS-940DW) To turn the machine on after the Auto Power Off feature has turned it off, press . <hr/> <p> (DSmobile DS-940DW) If the machine is connected to the computer using a USB cable and the battery is not fully charged, the machine automatically turns itself off and goes into Battery Charge Mode when the specified time elapses. (The Battery LED blinks.) The machine turns off after the battery is fully charged or when the USB cable is disconnected from the machine or computer.</p>





Related Information

- [Remote Setup \(Windows\)](#)
- [Remote Setup \(Mac\)](#)

Remote Setup (Mac)

- [Set Up the Brother Machine Using Remote Setup \(Mac\)](#)
- [Change the General Settings Using Remote Setup](#)

Set Up the Brother Machine Using Remote Setup (Mac)

1. (DSmobile DS-940DW) Slide the Mode Select Switch to  or .
2. In the **Finder** menu bar, click **Go > Applications > Brother**, select your model name, and then double-click the **Remote Setup** icon.

If the Discover Devices dialog box appears, select your model name and then click **Connect**.



(DSmobile DS-940DW)

When your machine is connected via a Network, type the password if required. If you have not previously set your own password, type the default login password.

The default login password is either:

- the password located on the bottom of the machine and preceded by "**Pwd**".
- **initpass**

The Remote Setup Program window appears.

3. Configure the settings as needed.

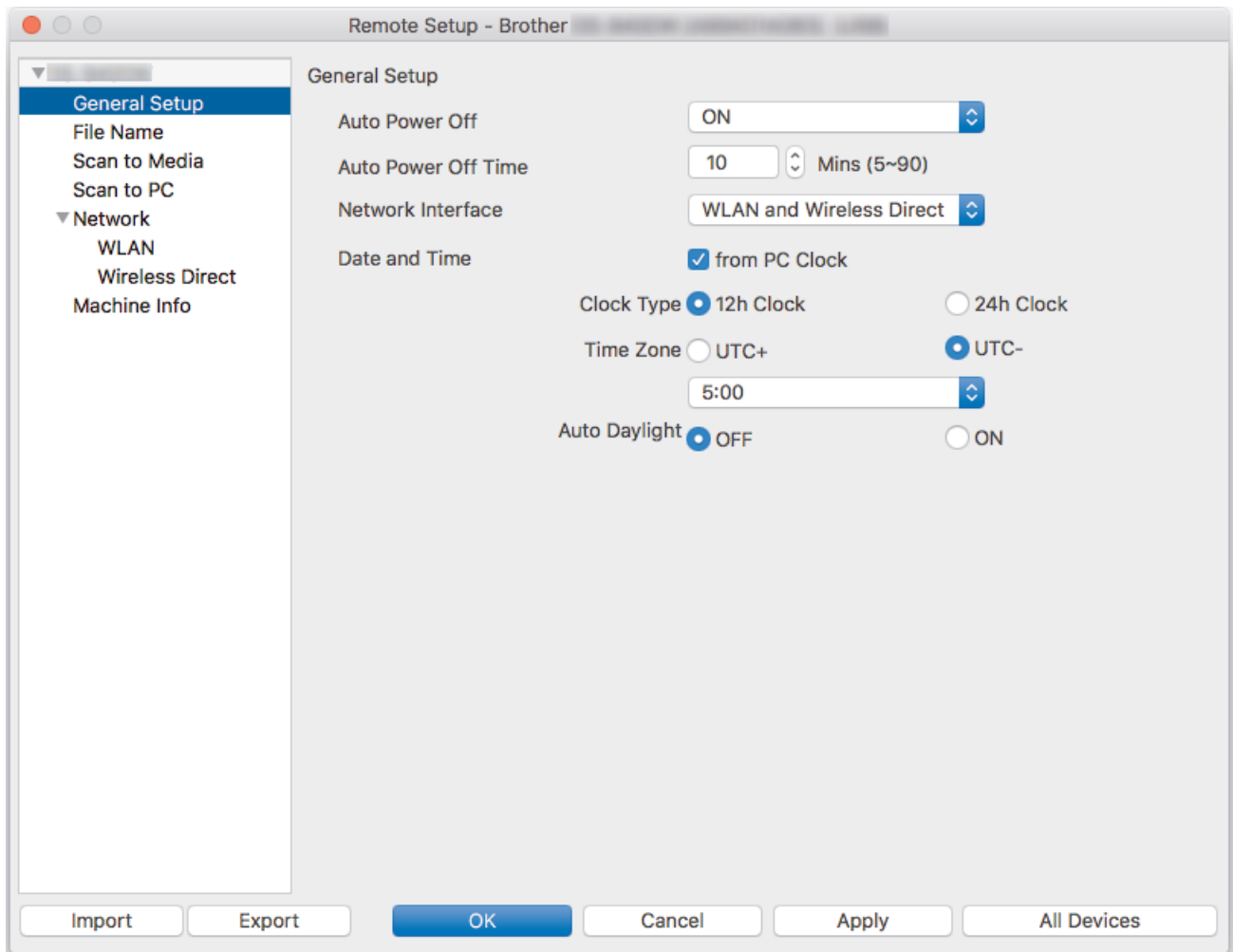

- Your screen may differ from the screen shown.
- (DSmobile DS-940DW) When the machine and computer are connected wirelessly, select **Scan to PC** in the navigation tree and configure scan settings to enable scanning from the **START/STOP** button on the machine.

Export

Click to save the current configuration settings to a file.

Import

Click to import a file and read its settings.

OK

Click to start uploading data to the machine, and then exit the Remote Setup Program. If an error message appears, confirm that your data is correct, and then click **OK**.

Cancel

Click to exit the Remote Setup Program without uploading data to the machine.

Apply



Click to upload data to the machine without exiting the Remote Setup Program.

4. Click **OK**.

**Related Information**

- [Remote Setup \(Mac\)](#)

Change the General Settings Using Remote Setup

Purpose	Operation (Windows/Mac)	Description
Set the Date and Time (DSmobile DS-940DW)	General Setup > Date and Time	Set the date and time. If you set Auto Daylight to On, the time will be adjusted forward one hour in the spring and adjusted backward one hour in the autumn.
Set the Machine to Power Off Automatically	General Setup > Auto Power Off General Setup > Auto Power Off Time	<p>Select how long the machine must wait before it automatically turns itself off. The Auto Power Off feature can save power consumption.</p> <ul style="list-style-type: none"> (DSmobile DS-640/DSmobile DS-740D) To turn the machine on after the Auto Power Off feature has turned it off, press START/STOP. (DSmobile DS-940DW) To turn the machine on after the Auto Power Off feature has turned it off, press . <hr/> <p> (DSmobile DS-940DW) If the machine is connected to the computer using a USB cable and the battery is not fully charged, the machine automatically turns itself off and goes into Battery Charge Mode when the specified time elapses. (The Battery LED blinks.) The machine turns off after the battery is fully charged or when the USB cable is disconnected from the machine or computer.</p>

Related Information

- [Remote Setup \(Windows\)](#)
- [Remote Setup \(Mac\)](#)

Appendix

- [Specifications](#)
- [Brother Help and Customer Support](#)

Specifications

- >> General Specifications
- >> Document Specifications
- >> Scanner Specifications
- >> Rechargeable Li-ion Battery (DSmobile DS-940DW)
- >> Interface Specifications
- >> Network Specifications (DSmobile DS-940DW)
- >> Supported Protocols and Security Features (DSmobile DS-940DW)
- >> Computer Requirements Specifications

General Specifications

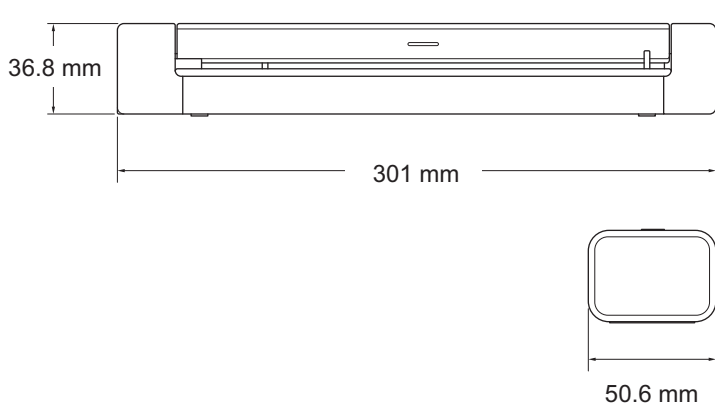
Memory Capacity	Standard	DSmobile DS-640: 128 MB DSmobile DS-740D: 256 MB DSmobile DS-940DW: 512 MB
Power Source		DSmobile DS-640/DSmobile DS-740D: USB bus-power DSmobile DS-940DW: USB bus-power/rechargeable Li-ion battery
Power Consumption ¹	Scanning	DSmobile DS-640: Approx. 2.6 W DSmobile DS-740D: Approx. 3.3 W DSmobile DS-940DW: <ul style="list-style-type: none"> • Approx. 4.6 W (Wi-Fi Mode) • Approx. 4.2 W (USB Mode)
	Ready	DSmobile DS-640: Approx. 1.4 W DSmobile DS-740D: Approx. 1.4 W DSmobile DS-940DW ² : <ul style="list-style-type: none"> • Approx. 2.3 W (Wi-Fi Mode) • Approx. 1.6 W (USB Mode)
	Power Down	DSmobile DS-640: Approx. 0.01 W DSmobile DS-740D: Approx. 0.01 W DSmobile DS-940DW ² : Approx. 0.11 W
Dimensions		<p>DSmobile DS-640:</p>  <p>DSmobile DS-740D:</p>

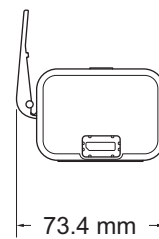
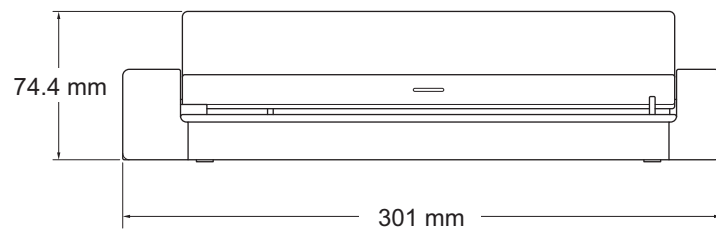
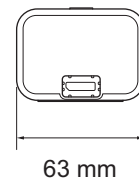
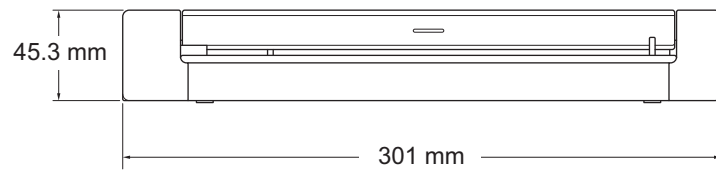

DSmobile DS-940DW:

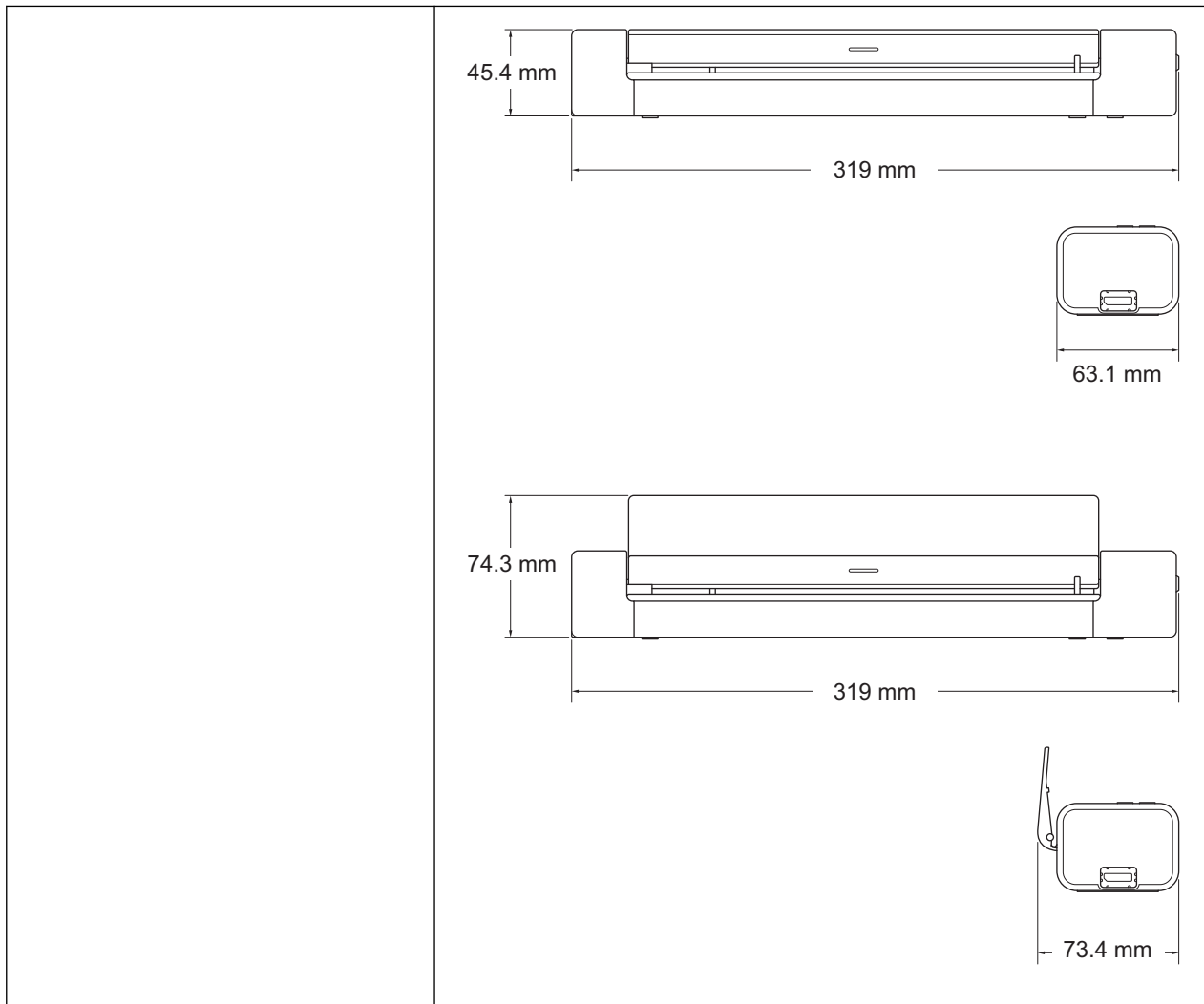

Weights		DSmobile DS-640: Approx. 466 g DSmobile DS-740D: Approx. 646 g DSmobile DS-940DW: Approx. 699 g
Temperature	Operating	5°C to 35°C ³
	Storage	-20°C to 60°C
Humidity	Operating	20% to 80%
	Storage	10% to 90%

- 1 Measured when the machine is connected to the USB interface.
- 2 (DSmobile DS-940DW) Measured when the rechargeable Li-ion battery is fully charged.
- 3 (DSmobile DS-940DW) Charging stops when the temperature of the specifications is exceeded.

Document Specifications

Paper Type	Photo, Paper, Card (embossed), Business Card, Receipt
Document Size	DSmobile DS-640: <ul style="list-style-type: none"> • 86.4 mm x 50.8 mm to 1828.8 mm x 215.9 mm DSmobile DS-740D/DSmobile DS-940DW: <ul style="list-style-type: none"> • Single-sided Scan 86.4 mm x 50.8 mm to 1828.8 mm x 215.9 mm • 2-sided Scan 86.4 mm x 50.8 mm to 406.48 mm x 215.9 mm • Output Guide 105 mm x 74 mm to 297 mm x 215.9 mm

Scanner Specifications

Colour/Monochrome		Yes/Yes
TWAIN Compliant	Windows	Windows 7 (SP1) / Windows 8.1 / Windows 10 Windows Server 2012 / Windows Server 2012 R2 / Windows Server 2016 / Windows Server 2019
WIA Compliant	Windows	Windows 7 (SP1) / Windows 8.1 / Windows 10
ICA Compliant	Mac	macOS v10.12.x / v10.13.x / v10.14.x ¹
Colour Depth	Input	48 bit colour processing
	Output	24 bit colour processing
Resolution	Interpolated	Up to 1200 x 1200 dpi
	Optical	Up to 600 x 600 dpi
Scanning Width		Up to 215.9 mm
Greyscale		256 levels
Max. Speed		See your model's page on your local Brother website.

¹ For the latest macOS driver updates, visit support.brother.com.

Rechargeable Li-ion Battery (DSmobile DS-940DW)

Charging Time	2.6 hours
Continuous Standby Time	10 minutes (when the Auto Power Off feature is active)
Scannable Number of Sheets (WLAN ON)	200 sheets
Scannable Number of Sheets (WLAN OFF)	320 sheets



- The numbers described in the Rechargeable Li-ion Battery table may differ depending on the documents scanned and on environmental factors, such as temperature and the charging and discharging method.
- For longer battery life, turn the scanner off when you are not using it.

Interface Specifications

USB	USB 3.0 ¹ Use a USB 3.0 cable (Standard A/Micro B) or USB 2.0 interface cable (Standard A/Micro B) that is no more than 2.0 metres long.
Memory Card (DSmobile DS-940DW)	microSD memory card: 2 GB - 32 GB (SDHC)
Wireless LAN (DSmobile DS-940DW)	IEEE 802.11b/g/n (Infrastructure mode) IEEE 802.11g (Wireless Direct)

¹ Your machine has a USB 3.0 interface. The machine can also be connected to a computer that has a USB 2.0 interface. Third-party USB ports are not supported.

Network Specifications (DSmobile DS-940DW)

Wireless Network Security	WEP 64/128 bit, WPA-PSK (TKIP/AES), WPA2-PSK (AES)
Setup Support Utility	WPS WLAN Assistant

Supported Protocols and Security Features (DSmobile DS-940DW)

Protocol (IPv4)	DHCP, APIPA (Auto IP), WINS/NetBIOS, DNS Resolver, mDNS, SNMPv1/v2c, ICMP, Web Services (Scan), HTTP/HTTPS server, LLNMR responder, SNTP Client
Protocol (IPv6)	RA, DNS Resolver, mDNS, LLNMR responder, Web Services (Scan), SNTP Client, HTTP/HTTPS server, ICMPv6
Network Security (Wireless)	SSL/TLS (HTTPS)
Wireless Certification	Wi-Fi Certification Mark License (WPA™/WPA2™ - Personal), Wi-Fi Protected Setup™ (WPS) Identifier Mark License

Computer Requirements Specifications

Computer Platform & Operating System Version		Supported PC Software Functions	PC Interface	Processor Minimum Speed	Hard Disk Space to Install	
					For Drivers	For Applications
Windows Operating System	Windows 7 (SP1)	Scanning	USB (DSmobile DS-640/DSmobile DS-740D) USB/Wireless 802.11b/g/n (DSmobile DS-940DW)	32bit (x86) or 64bit (x64) processor	70 MB	Drivers, Installer and Software: 1.4 GB
	Windows 8.1					
	Windows 10					
	Windows Server 2012			64bit (x64) processor	70 MB	
	Windows Server 2012 R2					
	Windows Server 2016					
	Windows Server 2019					
Mac Operating System	macOS v10.12.x			Intel® Processor	30 MB	Drivers and Software: 600 MB
	macOS v10.13.x					
	macOS v10.14.x					

For the latest driver updates, visit support.brother.com. All trademarks, brand and product names are property of their respective companies.

Related Information

- [Appendix](#)

Brother Help and Customer Support

If you need help with using your Brother product, visit support.brother.com for FAQs and troubleshooting tips. You can also download the latest software, drivers and firmware, to improve the performance of your machine, and user documentation, to learn how to get the most from your Brother product.

Further product and support information is available from your local Brother office website. Visit <https://global.brother/en/gateway> to find the contact details for your local Brother office and to register your new product.



Related Information

- [Appendix](#)

brother

Visit us on the World Wide Web
global.brother/gw



UK
Version B