



Online User's Guide

DCP-T220

DCP-T225

DCP-T226

DCP-T420W

DCP-T425W

DCP-T426W

Table of Contents

| | |
|---|-----------|
| Before You Use Your Machine | 1 |
| Definitions of Notes | 2 |
| Trademarks | 3 |
| Important Notes..... | 4 |
| Introduction to Your Machine | 5 |
| Before Using Your Machine | 6 |
| Control Panel Overview | 7 |
| LED Patterns and Indications | 9 |
| Access Brother Utilities (Windows) | 10 |
| Uninstall the Brother Software and Drivers (Windows) | 11 |
| USB Port Location on Your Brother Machine | 12 |
| Paper Handling | 13 |
| Load Paper..... | 14 |
| Load Paper in the Paper Tray | 15 |
| Load Paper in the Manual Feed Slot..... | 24 |
| Unprintable Area | 27 |
| Paper Settings..... | 28 |
| Acceptable Paper and Other Print Media..... | 30 |
| Load Documents | 37 |
| Load Documents on the Scanner Glass | 38 |
| Unscannable Area | 39 |
| Print | 40 |
| Print from Your Computer (Windows)..... | 41 |
| Print a Photo (Windows)..... | 42 |
| Print a Document (Windows)..... | 43 |
| Cancel a Print Job (Windows)..... | 44 |
| Print More Than One Page on a Single Sheet of Paper (N in 1) (Windows)..... | 45 |
| Print as a Poster (Windows)..... | 46 |
| Print on Both Sides of the Paper Manually (Manual 2-sided Printing) (Windows) | 47 |
| Print as a Booklet Manually (Windows)..... | 50 |
| Print a Colour Document in Greyscale (Windows)..... | 52 |
| Prevent Smudged Printouts and Paper Jams (Windows) | 53 |
| Use a Preset Print Profile (Windows) | 54 |
| Change the Default Print Settings (Windows) | 57 |
| Print Settings (Windows) | 58 |
| Print Using Brother iPrint&Scan (Windows/Mac) | 62 |
| Print Photos or Documents Using Brother iPrint&Scan (Windows/Mac)..... | 63 |
| Print More Than One Page on a Single Sheet of Paper Using Brother iPrint&Scan (N in 1) (Windows/Mac)..... | 65 |
| Print a Colour Document in Greyscale Using Brother iPrint&Scan (Windows/Mac) | 66 |
| Print an Email Attachment..... | 67 |
| Scan | 68 |
| Scan Using the Buttons on Your Brother Machine..... | 69 |
| Scan Using the Buttons on Your Brother Machine | 70 |
| Scan to an Editable Text File Using OCR..... | 73 |

| | |
|--|------------|
| Save Scanned Data as an Email Attachment | 74 |
| Web Services for Scanning on Your Network (Windows 7, Windows 8.1, and Windows 10) | 75 |
| Scan Using Brother iPrint&Scan (Windows/Mac) | 79 |
| Scan from Your Computer (Windows)..... | 80 |
| Scan Using Nuance™ PaperPort™ 14SE or Other Windows Applications..... | 81 |
| Scan Using Windows Fax and Scan | 86 |
| Scan from Your Computer (Mac)..... | 89 |
| Scan Using Apple Image Capture (ICA Driver) | 90 |
| Copy | 91 |
| Copy Overview..... | 92 |
| Copy a Document | 93 |
| Copy an ID Card | 94 |
| Change the Copy Shortcut Button Settings Using Web Based Management..... | 95 |
| Copy Using Brother iPrint&Scan | 96 |
| Make Page Layout Copies (N in 1 or Poster)..... | 97 |
| Copy Settings | 99 |
| Network | 101 |
| Supported Basic Network Features | 102 |
| Configure Network Settings | 103 |
| Configure Network Settings Using the Control Panel..... | 104 |
| Wireless Network Settings | 105 |
| Use the Wireless Network | 106 |
| Use Wireless Direct..... | 113 |
| Enable/Disable Wireless LAN | 116 |
| Print the WLAN Report..... | 117 |
| Network Features..... | 120 |
| Print the Network Configuration Report..... | 121 |
| Reset the Network Settings to Factory Settings..... | 122 |
| Brother Management Tools | 123 |
| Security | 124 |
| Before Using Network Security Features | 125 |
| Configure Certificates for Device Security | 126 |
| Supported Security Certificate Features | 127 |
| Step by Step Guide for Creating and Installing a Certificate | 128 |
| Create a Self-signed Certificate | 129 |
| Create CSR and Install a Certificate from a Certificate Authority (CA) | 130 |
| Import and Export the Certificate and Private Key | 134 |
| Manage Multiple Certificates | 137 |
| Use SSL/TLS | 138 |
| Introduction to SSL/TLS | 139 |
| Manage Your Network Machine Securely Using SSL/TLS..... | 142 |
| Print Documents Securely Using SSL/TLS | 147 |
| Mobile Connect | 149 |
| Mopria™ Print Service and Mopria™ Scan..... | 150 |
| Brother iPrint&Scan..... | 151 |
| Brother iPrint&Scan Overview for Windows and Mac..... | 152 |





| | |
|--|------------|
| Brother iPrint&Scan Overview for Mobile Devices | 153 |
| Troubleshooting | 154 |
| Error and Maintenance LED Indications | 155 |
| Printer Jam or Paper Jam | 158 |
| Paper is Jammed Inside the Machine | 159 |
| If You Are Having Difficulty with Your Machine | 162 |
| Paper Handling and Printing Problems | 163 |
| Other Problems | 168 |
| Network Problems | 169 |
| Check the Machine Information | 177 |
| Reset Your Machine | 178 |
| Routine Maintenance | 179 |
| Refill the Ink Tanks | 180 |
| Clean Your Brother Machine | 185 |
| Clean the Scanner | 186 |
| Clean the Print Head from Your Brother Machine | 187 |
| Clean the Print Head Using Web Based Management | 188 |
| Clean the Print Head from Your Computer (Windows)..... | 189 |
| Clean the Outside of the Machine | 191 |
| Clean the Machine's Printer Platen | 192 |
| Clean the Paper Feed Rollers | 193 |
| Clean the Base Pad | 194 |
| Clean the Paper Pick-up Rollers | 195 |
| Check Your Brother Machine | 196 |
| Check the Print Quality..... | 197 |
| Monitor Machine Status from Your Computer (Windows) | 198 |
| Monitor Machine Status Using Brother iPrint&Scan (Windows/Mac) | 202 |
| Check the Print Alignment from Your Brother Machine..... | 204 |
| Check the Print Alignment Using Web Based Management..... | 205 |
| Change the Print Options to Improve Your Print Results | 206 |
| Pack and Ship Your Brother Machine | 207 |
| Machine Settings..... | 209 |
| Change Machine Settings Using Web Based Management | 210 |
| What is Web Based Management? | 211 |
| Access Web Based Management | 212 |
| Set or Change a Login Password for Web Based Management..... | 214 |
| General Settings..... | 215 |
| In the Event of Power Failure (Memory Storage)..... | 221 |
| Appendix..... | 222 |
| Specifications | 223 |
| Supply Specifications | 228 |
| Information Regarding Recycled Paper | 229 |
| Brother Help and Customer Support..... | 230 |

Before You Use Your Machine

- [Definitions of Notes](#)
- [Trademarks](#)
- [Important Notes](#)

Definitions of Notes

We use the following symbols and conventions throughout this User's Guide:

| | |
|--|---|
|  WARNING | WARNING indicates a potentially hazardous situation which, if not avoided, could result in death or serious injuries. |
|  CAUTION | CAUTION indicates a potentially hazardous situation which, if not avoided, may result in minor or moderate injuries. |
| IMPORTANT | IMPORTANT indicates a potentially hazardous situation which, if not avoided, may result in damage to property or loss of product functionality. |
| NOTE | NOTE specifies the operating environment, conditions for installation, or special conditions of use. |
|  | Tips icons indicate helpful hints and supplementary information. |
|  | Electrical Hazard icons alert you to possible electrical shock. |
| Bold | Bold style identifies buttons on the machine's control panel or computer screen. |
| <i>Italics</i> | Italicised style emphasises an important point or refers you to a related topic. |

Related Information

- [Before You Use Your Machine](#)

Trademarks

Apple, Mac, iPad, iPhone, iPod touch and macOS are trademarks of Apple Inc., registered in the United States and other countries.

Nuance and PaperPort are trademarks or registered trademarks of Nuance Communications, Inc. or its affiliates in the United States and/or other countries.

Wi-Fi® and Wi-Fi Alliance® are registered trademarks of Wi-Fi Alliance®.

WPA™, WPA2™, and Wi-Fi Protected Setup™ are trademarks of Wi-Fi Alliance®.

Mopria™ and the Mopria™ Logo are registered and/or unregistered trademarks and service marks of Mopria Alliance, Inc. in the United States and other countries. Unauthorised use is strictly prohibited.

Each company whose software title is mentioned in this manual has a Software Licence Agreement specific to its proprietary programs.

Any trade names and product names of companies appearing on Brother products, related documents and any other materials are all trademarks or registered trademarks of those respective companies.



Related Information

- [Before You Use Your Machine](#)
-

Important Notes

- Check support.brother.com for Brother driver and software updates.
- To keep your machine performance up to date, check support.brother.com for the latest firmware upgrade. Otherwise, some of your machine's functions may not be available.
- Do not use this product outside the country of purchase as it may violate the wireless telecommunication and power regulations of that country.
- Windows 10 in this document represents Windows 10 Home, Windows 10 Pro, Windows 10 Education and Windows 10 Enterprise.
- Windows 11 in this document represents Windows 11 Home, Windows 11 Pro, Windows 11 Education and Windows 11 Enterprise.
- Windows Server 2008 in this document represents Windows Server 2008 and Windows Server 2008 R2.
- In this User's Guide, the illustrations of the DCP-T420W are used unless otherwise specified.
- The screens in this User's Guide are for illustration purposes only and may differ from the actual screens.
- Unless otherwise specified, the screens in this manual are from Windows 10 and macOS v10.15.x. Screens on your computer may vary depending on your operating system.
- The contents of this guide and the specifications of this product are subject to change without notice.
- In this document XXX-XXXX represents your machine's model name.



Related Information

- [Before You Use Your Machine](#)
-

Introduction to Your Machine

- [Before Using Your Machine](#)
- [Control Panel Overview](#)
- [LED Patterns and Indications](#)
- [Access Brother Utilities \(Windows\)](#)
- [USB Port Location on Your Brother Machine](#)

Before Using Your Machine

Before attempting any printing operation, confirm the following:

- Make sure you have installed the correct software and drivers for your machine.
- For USB cable users: Make sure the interface cable is physically secure.

Selecting the correct type of paper

For high quality printing, it is important to select the correct type of paper. Be sure to read the information about acceptable paper before buying paper, and to determine the printable area depending on the settings in the printer driver or in the application you use to print.

Firewall (Windows) (DCP-T420W/DCP-T425W/DCP-T426W)

If your computer is protected by a firewall and you are unable to network print or network scan, you may need to configure the firewall settings. If you are using the Windows Firewall and you installed the drivers using the steps in the installer, the necessary firewall settings have been already set. If you are using any other personal firewall software, see the User's Guide for your software or contact the software manufacturer.



Related Information

- [Introduction to Your Machine](#)
-

Control Panel Overview

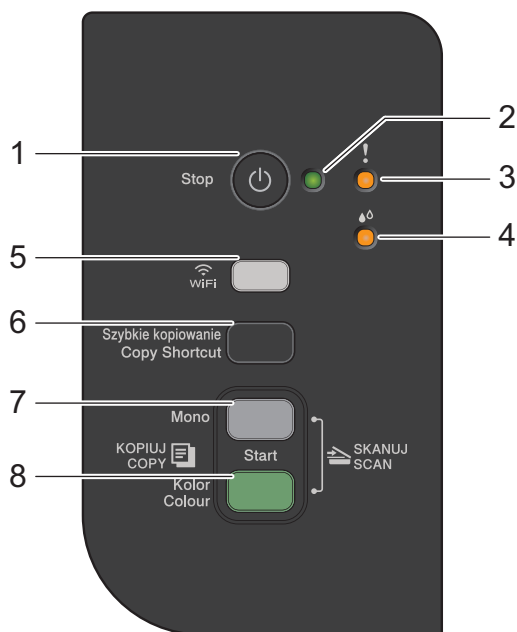

1. (Stop) Power On/Off

- Press to stop an operation.
- Press to exit from a selected mode.
- Press to turn on the machine.

Press and hold down to turn off the machine and cancel all of the remaining operations. The **Power LED** blinks and stays on for a few seconds before turning itself off.

If you turn off the machine using , it will still clean the print head periodically to maintain print quality. To prolong print head life, provide better ink efficiency, and maintain print quality, keep your machine connected to a power source at all times.

2. Power LED

Indicates the machine's status.

3. Warning LED

Indicates when the machine detects an error or is in Reset Mode.

4. Ink LED

Indicates when the machine detects an ink error or is in Maintenance Mode.

5. WiFi Button/LED (DCP-T420W/DCP-T425W/DCP-T426W)

- Press the button by itself or simultaneously with another button to configure the wireless settings or print network reports. Use only when the machine is idle.
- Press this button and **Colour Start** simultaneously to restart the Wi-Fi if you cannot connect to your wireless network.
- Press simultaneously with (**Stop**) to access the Wi-Fi Mode.
- Indicates the wireless network status.

| | |
|--|------------|
| | Connected |
| | Connecting |
| | Off |

6. Copy Shortcut

- Press to make a 2 in 1 ID copy.
If necessary, one of the specific copy functions can be set as a function for this button using Web Based Management. By default, 2 in 1 ID copy is set.
- Press simultaneously with  (**Stop**) to access the Maintenance Mode.

7. Mono Start

- Press to start making copies in monochrome.
- Press simultaneously with **Colour Start** to start scanning documents (in colour or monochrome, depending on the scan setting).
- Press simultaneously with  (**Stop**) to access the Reset Mode.

8. Colour Start

Press to start making copies in full colour.







Related Information

- [Introduction to Your Machine](#)
-

LED Patterns and Indications

The LEDs on your machine's control panel light up or blink to indicate machine status.

| LED | Description |
|---|----------------------|
|  | The LED is off. |
|  | The LED is lit. |
|  | The LED is blinking. |

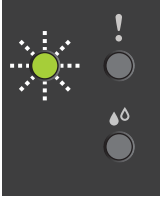
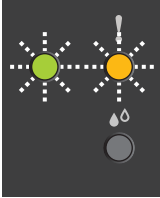
| LED | Status | Description |
|---|-------------------------------------|---|
|  (Lit) | Standby | The machine is ready to print. |
|  (Blinking) | Busy | The machine is processing a print job. |
| | Sleep (blinking slowly and faintly) | In Sleep mode (Power Save mode), the machine acts as if it is turned off, but it can still receive data. When you send a print job, the machine wakes up. |
| | Warming Up (Low Temperature) | The machine is warming up. |
| | Cooling Down (High Temperature) | The machine is cooling down. |
| | Data Remaining | There is print data in the machine's memory. To cancel the job and clear it from machine memory, press Stop . |
|  (Blinking alternately) | Job Cancelled | The machine is cancelling the print job. |



Related Information

- [Introduction to Your Machine](#)

Related Topics:

- [Error and Maintenance LED Indications](#)

Access Brother Utilities (Windows)

Brother Utilities is an application launcher that offers convenient access to all Brother applications installed on your computer.

1. Do one of the following:

- Windows 10

Click  > **Brother** > **Brother Utilities**.

- Windows 8.1

Move your mouse to the lower left corner of the **Start** screen and click  (if using a touch-based device, swipe up from the bottom of the **Start** screen to bring up the **Apps** screen).

When the **Apps** screen appears, tap or click  (**Brother Utilities**).

- Windows 7

Click  (**Start**) > **All Programs** > **Brother** > **Brother Utilities**.

2. Select your machine.

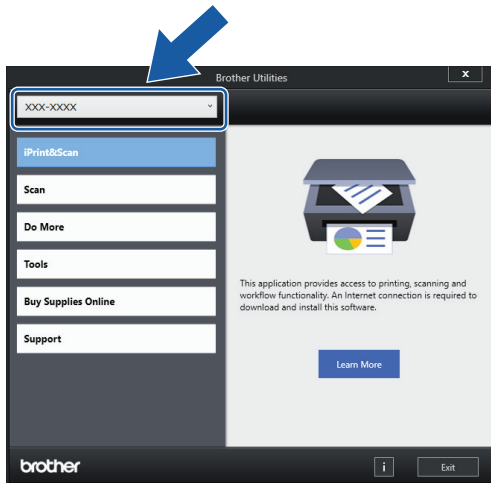

3. Select the operation you want to use.

Related Information

- Introduction to Your Machine
 - Uninstall the Brother Software and Drivers (Windows)

Uninstall the Brother Software and Drivers (Windows)

1. Do one of the following:

- Windows 10

Click  > **Brother** > **Brother Utilities**.

- Windows 8.1

Move your mouse to the lower left corner of the **Start** screen and click  (if using a touch-based device, swipe up from the bottom of the **Start** screen to bring up the **Apps** screen).

When the **Apps** screen appears, tap or click  (**Brother Utilities**).

- Windows 7

Click  (**Start**) > **All Programs** > **Brother** > **Brother Utilities**.

2. Click the drop-down list, and then select your model name (if not already selected). Click **Tools** in the left navigation bar, and then click **Uninstall**.

Follow the instructions in the dialog box to uninstall the software and drivers.

Related Information

- [Access Brother Utilities \(Windows\)](#)

USB Port Location on Your Brother Machine

The USB port is located under the document cover.

To install the driver and software necessary to use your machine, go to your model's **Downloads** page at support.brother.com.

(Windows) Or, use the Brother installation disc to set up your machine (not available in all countries).

1. Lift the document cover.

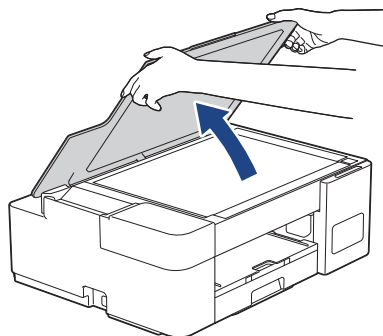

2. Locate the correct port under the document cover as shown.

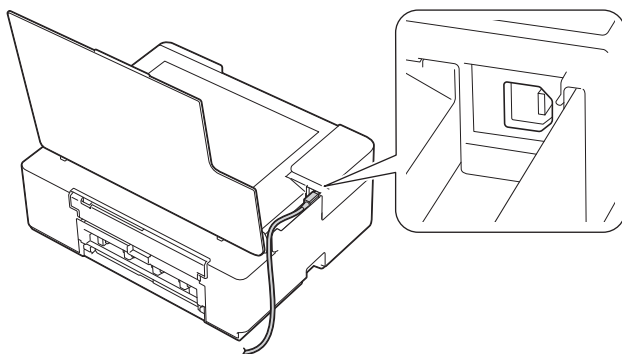

 Carefully guide the cable through the cable channel and out the back of the machine.

3. Gently close the document cover.

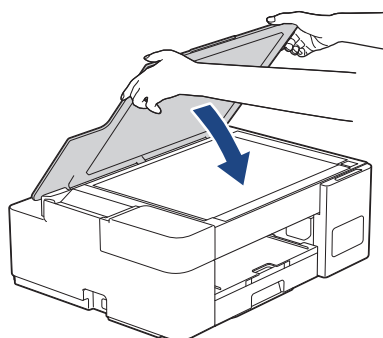

Related Information

- [Introduction to Your Machine](#)

Paper Handling

- [Load Paper](#)
- [Load Documents](#)

Load Paper

- [Load Paper in the Paper Tray](#)
- [Load Paper in the Manual Feed Slot](#)
- [Unprintable Area](#)
- [Paper Settings](#)
- [Acceptable Paper and Other Print Media](#)
- [Error and Maintenance LED Indications](#)
- [Paper Handling and Printing Problems](#)

Load Paper in the Paper Tray

- [Load Cut-Sheet Paper or Photo 2L Paper in the Paper Tray](#)
- [Load Photo Paper in the Paper Tray](#)
- [Load Envelopes in the Paper Tray](#)

Load Cut-Sheet Paper or Photo 2L Paper in the Paper Tray

- Load only one size and type of paper in the paper tray at a time.
- When you load a different paper size in the tray, you must change the paper size setting on your computer.

1. If the paper support flap (1) is open, close it, and then close the paper support (2).

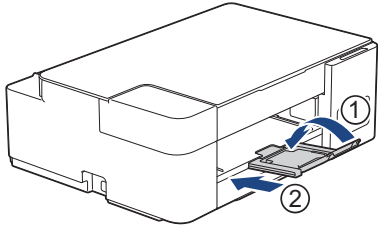

2. Pull the paper tray completely out of the machine.

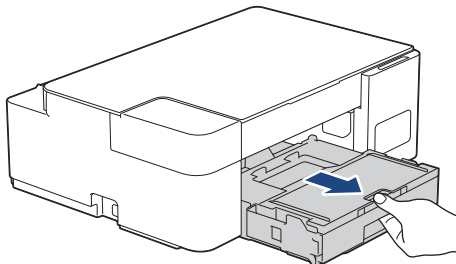

3. Lift the output paper tray cover (1).

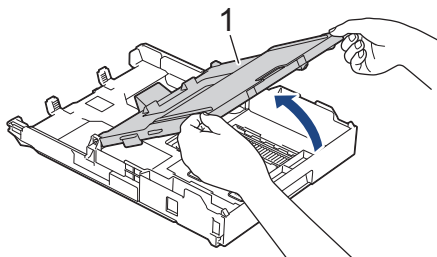

4. Gently press and slide the paper width guides (1) and then the paper length guide (2) to fit the paper size.

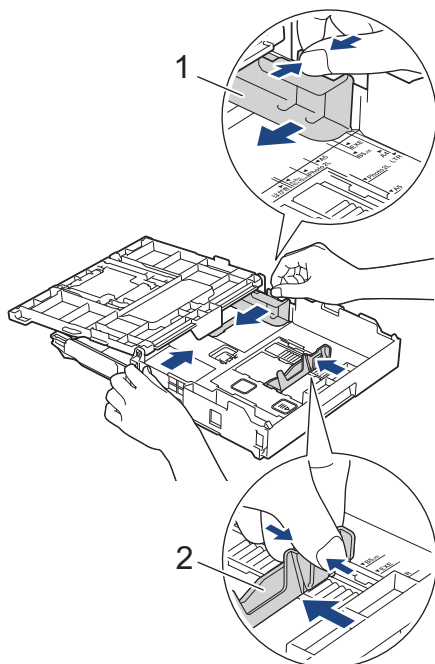

5. Fan the stack of paper well to avoid paper jams and misfeeds.

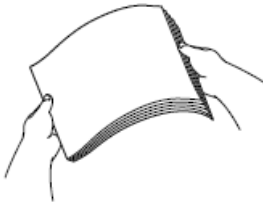

Always make sure the paper is not curled or wrinkled.

6. Gently load paper in the paper tray with the printing surface **face down**.

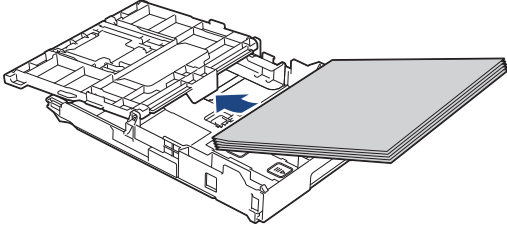

Make sure the paper is flat in the tray and the paper length guide (1) touches the edges of the paper.

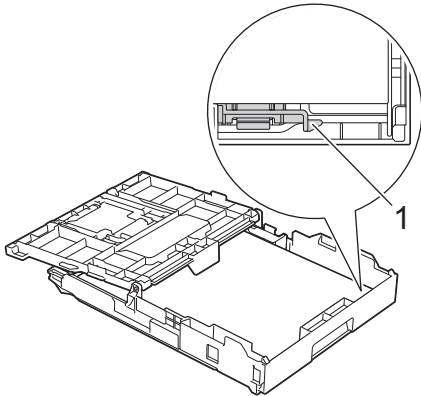

IMPORTANT

- Be careful not to push the paper in too far; it may lift at the back of the tray and cause paper feed problems.
- Loading more than 20 sheets of Photo 2L (13 x 18 cm) paper may cause paper jams.



To add paper before the tray is empty, remove the paper from the tray and combine it with the paper you are adding. Always fan the stack of paper well to prevent the machine from feeding multiple pages.

7. Gently adjust the paper width guides (1) to fit the paper.

Make sure the paper width guides touch the edges of the paper.

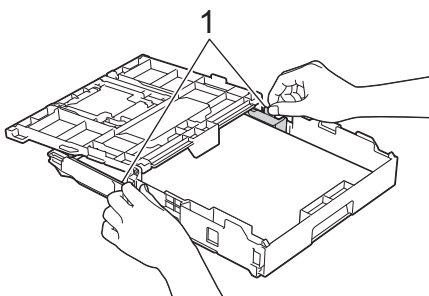

8. Close the output paper tray cover.

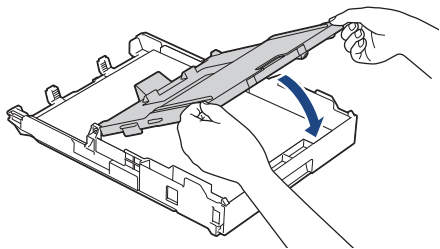

9. Slowly push the paper tray completely into the machine.

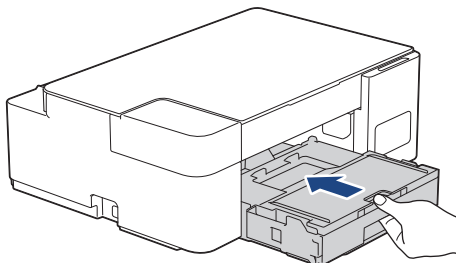

10. Pull out the paper support (1) until it locks into place, and then unfold the paper support flap (2).

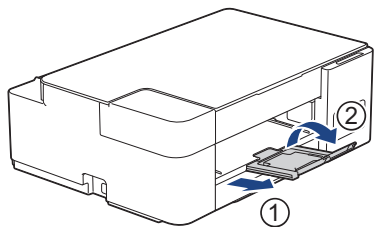

 **Related Information**

- [Load Paper in the Paper Tray](#)

Related Topics:

- [Choose the Right Print Media](#)
-

Load Photo Paper in the Paper Tray

- Load only one size and type of paper in the paper tray at a time.
- When you load a different paper size in the tray, you must change the paper size setting on your computer.

1. If the paper support flap (1) is open, close it, and then close the paper support (2).

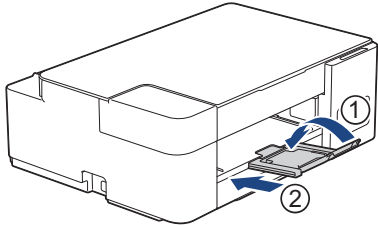

2. Pull the paper tray completely out of the machine.

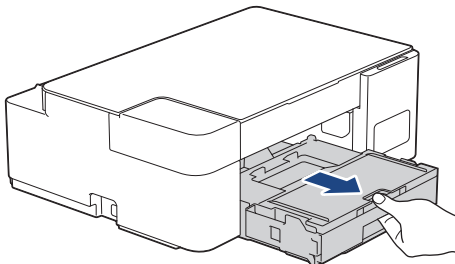

3. Lift the output paper tray cover (1).

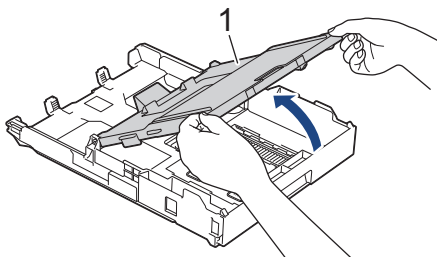

4. Gently press and slide the paper width guides (1) to fit the paper size, and then lift the stopper (2).

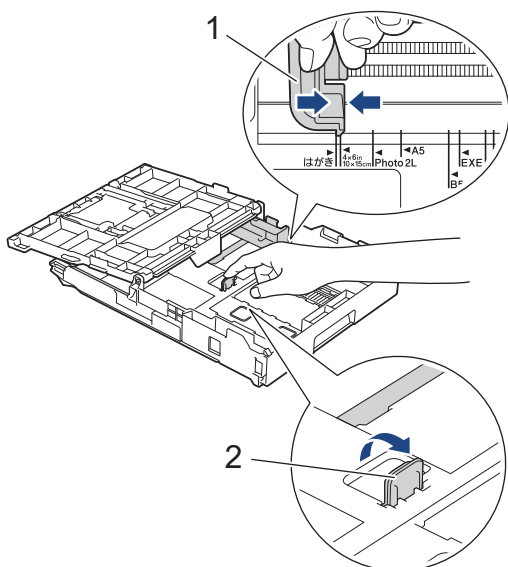

5. Close the output paper tray cover.

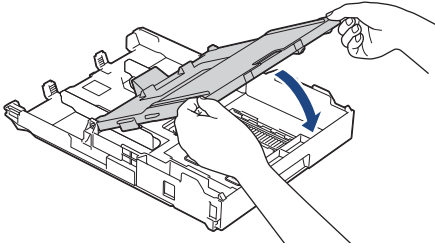

6. Load up to 20 sheets of photo paper with the printing surface **face down**.
Loading more than 20 sheets of photo paper may cause paper jams.

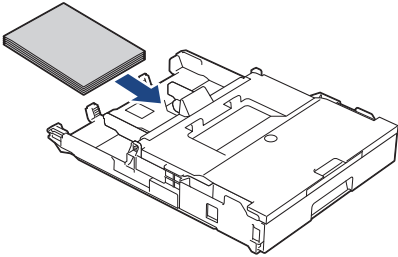

7. Lift the output paper tray cover.
8. Gently adjust the paper width guides (1) to fit the paper.
Make sure the paper width guides touch the edges of the paper and the paper is flat in the tray.

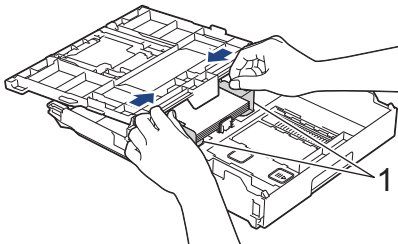

9. Close the output paper tray cover.
10. Slowly push the paper tray completely into the machine.

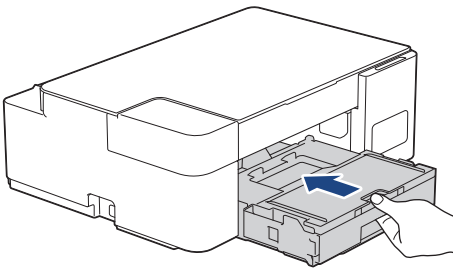

11. Pull out the paper support (1) until it locks into place, and then unfold the paper support flap (2).

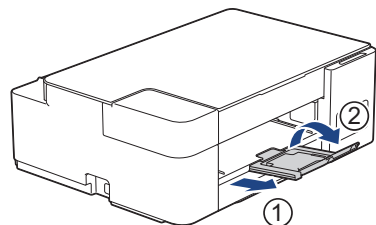

✓ Related Information

- [Load Paper in the Paper Tray](#)

Related Topics:

- [Choose the Right Print Media](#)

Load Envelopes in the Paper Tray

- You can load envelopes in a variety of sizes. See *Related Information: Paper Type and Paper Size for Each Operation*.
- When you load envelopes in the tray, you must change the paper size setting on your computer.
- Before loading envelopes in the tray, press the corners and sides of the envelopes to make them as flat as possible.

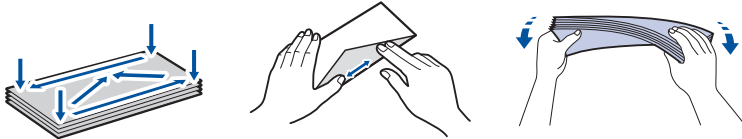

1. If the paper support flap (1) is open, close it, and then close the paper support (2).

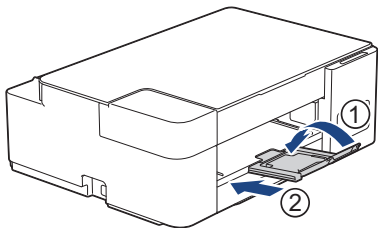

2. Pull the paper tray completely out of the machine.

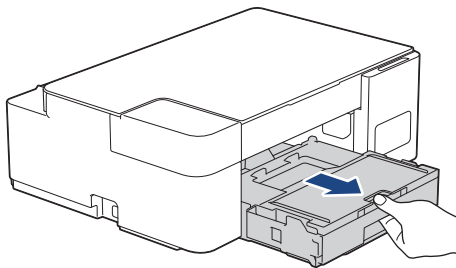

3. Lift the output paper tray cover (1).

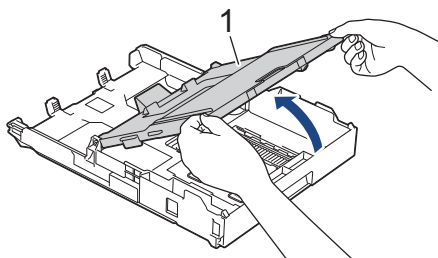

4. Load up to 10 envelopes in the paper tray with the printing surface **face down**. Loading more than 10 envelopes may cause paper jams.

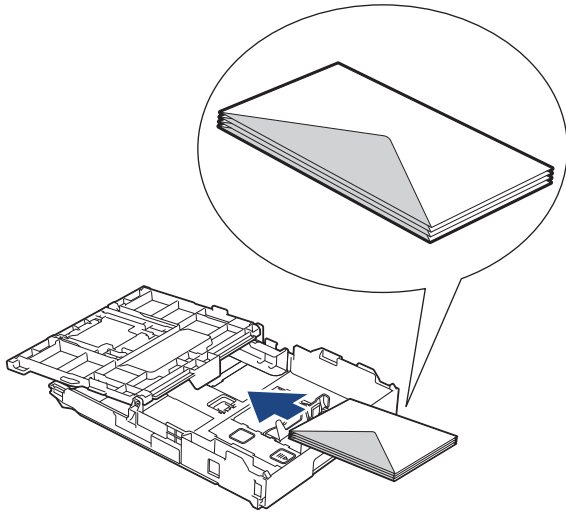

5. Gently press and slide the paper width guides (1) and paper length guide (2) to fit the size of the envelopes. Make sure the envelopes are flat in the tray.

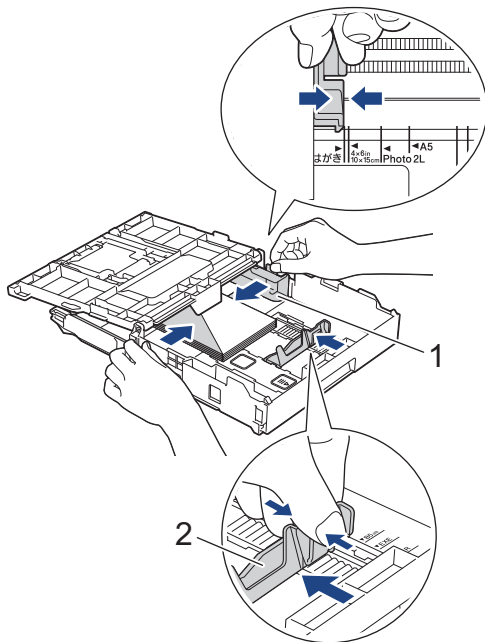

IMPORTANT

If envelopes are multi-feeding, load one envelope in the paper tray at a time.

6. Close the output paper tray cover.

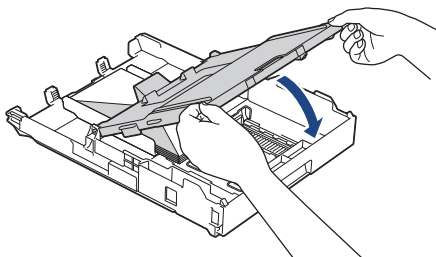

7. Slowly push the paper tray completely into the machine.

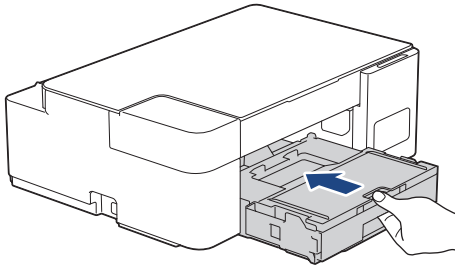

8. Pull out the paper support (1) until it locks into place, and then unfold the paper support flap (2).

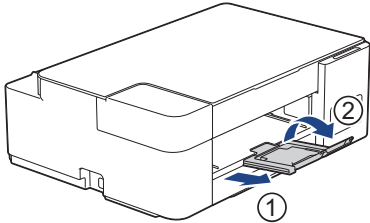

Related Information

- [Load Paper in the Paper Tray](#)

Related Topics:

- [Choose the Right Print Media](#)
 - [Paper Type and Paper Size for Each Operation](#)
-

Load Paper in the Manual Feed Slot

Load special print media in this slot, **one sheet of paper** at a time.



The machine automatically turns on Manual Feed mode when you put paper in the manual feed slot.

1. Open the manual feed slot cover.

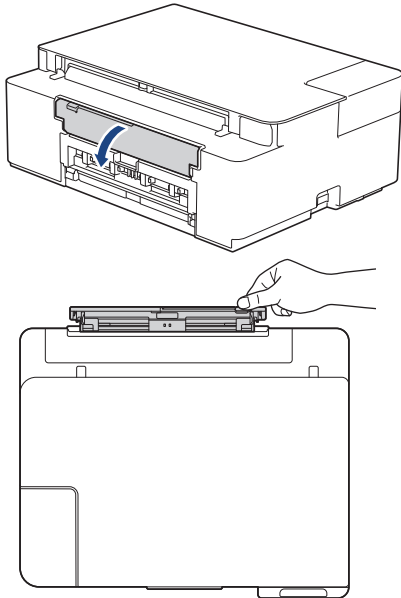

2. Lift the paper support.

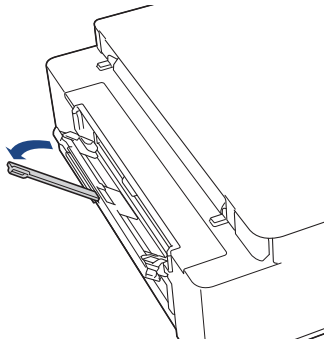

3. Slide the manual feed slot paper guides to fit the width of the paper you are using.

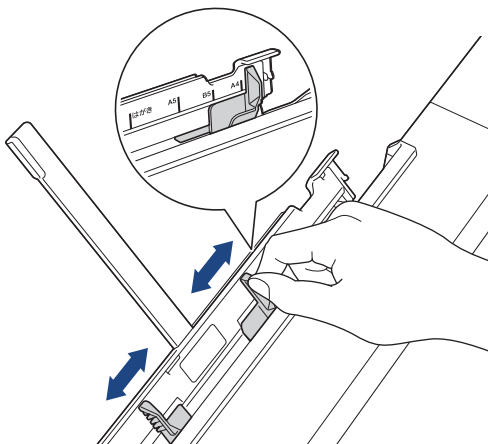

4. Load only **one sheet of paper** in the manual feed slot with the printing surface **face up**.

Using both hands, adjust the manual feed slot paper guides to make sure there is no gap between them and the paper.

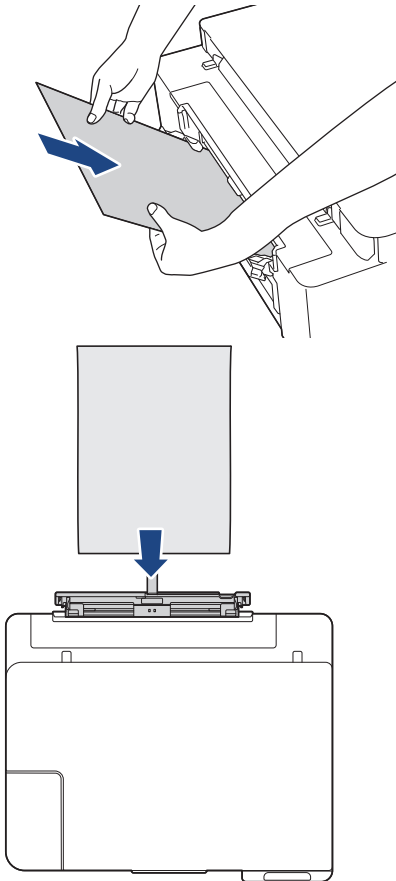

When using envelopes, load the envelopes with the printing surface **face up** and the flap on the left as shown in the illustration.

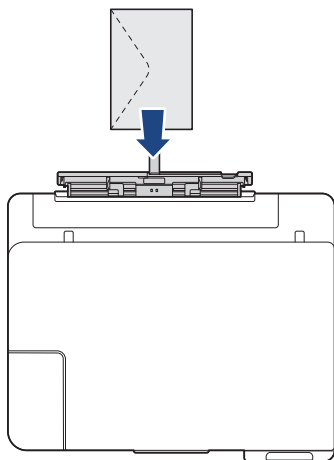

IMPORTANT

- DO NOT load more than **one sheet of paper** in the manual feed slot at any time. Doing this may cause a paper jam. When printing multiple pages, do not load the next sheet of paper until both the **Power LED** and the **Warning LED** are lit.
- DO NOT load paper in the manual feed slot when you are printing from the paper tray. Doing this may cause a paper jam.

-
5. Using both hands, push **one sheet of paper** into the manual feed slot until the front edge touches the paper feed rollers. Release the paper when you feel the machine pull it. The **Power LED** blinks three times to indicate the manual feed slot is ready.

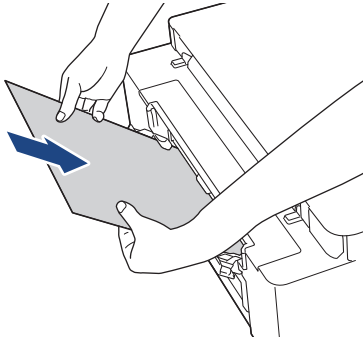

When loading an envelope, or a sheet of thick paper, push the media into the manual feed slot until you feel the paper feed rollers pull it.

6. Pull out the paper support (1) until it locks into place, and then unfold the paper support flap (2).

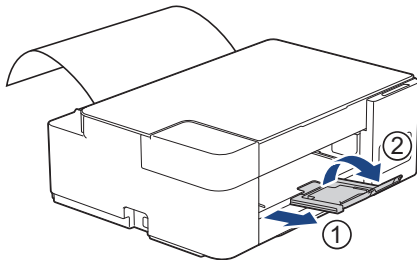

- If the document does not fit on one sheet, both the **Power LED** and the **Warning LED** light up. Place another sheet of paper in the manual feed slot, and then press **Mono Start** or **Colour Start**.
 - Make sure printing has finished before you close the manual feed slot cover.
 - When paper is placed in the manual feed slot, the machine always prints from the manual feed slot.
 - The machine will eject paper loaded in the manual feed slot if a test page or report is printing.
 - The machine will eject paper loaded in the manual feed slot during the machine's cleaning process. Wait until the machine finishes its cleaning, and then load paper in the manual feed slot.
-



Related Information

- [Load Paper](#)

Related Topics:

- [Choose the Right Print Media](#)
 - [Error and Maintenance LED Indications](#)
-

Unprintable Area

The unprintable area depends on the settings in the application you are using. The figures below show the unprintable areas on cut-sheet paper and envelopes. The machine can print in the shaded areas of cut-sheet paper only when the Borderless print feature is available and turned on.

Cut-Sheet Paper

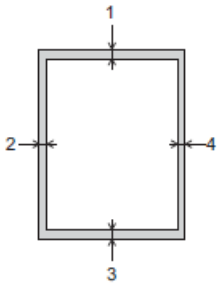

Envelopes

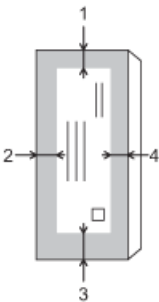

| | Top (1) | Left (2) | Bottom (3) | Right (4) |
|-----------|---------|----------|------------|-----------|
| Cut-Sheet | 3 mm | 3 mm | 3 mm | 3 mm |
| Envelopes | 12 mm | 3 mm | 12 mm | 3 mm |



The Borderless print feature is not available for envelopes and 2-sided printing.



Related Information

- [Load Paper](#)

Related Topics:

- [Paper Handling and Printing Problems](#)

Paper Settings

- [Change the Paper Size Settings](#)

Change the Paper Size Settings

1. Start Brother iPrint&Scan.

- Windows

Launch  (Brother iPrint&Scan).

- Mac

In the **Finder** menu bar, click **Go > Applications**, and then double-click the iPrint&Scan icon.

The Brother iPrint&Scan screen appears.

2. If your Brother machine is not selected, click the **Select your Machine** button, and then select your model name from the list. Click **OK**.

3. Click  (**Machine Settings**) to configure the settings.

4. If required, type the password in the **Login** field, and then click **Login**.



The default password to manage this machine's settings is located on the back of the machine and marked "Pwd".

5. Go to the navigation menu, and then click **Copy > Copy Options**.



Start from , if the navigation menu is not shown on the left side of the screen.

6. Select the **Paper Size** option.

7. Click **Submit**.



For high quality printing, it is important to select the correct type of paper. Be sure to read the information about acceptable paper before buying paper, and to determine the printable area depending on the settings in the printer driver or in the application you use to print.



Related Information

- [Paper Settings](#)

Related Topics:

- [Acceptable Paper and Other Print Media](#)
- [Copy a Document](#)
- [Access Web Based Management](#)
- [Brother iPrint&Scan](#)

Acceptable Paper and Other Print Media

The print quality can be affected by the type of paper you use in the machine.

To get the best print quality for the settings you have selected, always set the Paper Type to match the type of paper you load.

You can use plain paper, inkjet paper (coated paper), glossy paper, recycled paper, and envelopes.

We recommend testing various paper types before buying large quantities.

For best results, use Brother paper.

- When you print on inkjet paper (coated paper) and glossy paper, be sure to select the correct print media in the printer driver or in the application you use to print.
- When you print on photo paper, load one extra sheet of the same photo paper in the paper tray.
- When using photo paper, remove each sheet at once to prevent smudging or paper jams.
- Avoid touching the printed surface of the paper immediately after printing; the surface may not be completely dry and may stain your fingers.



Related Information

- [Load Paper](#)
 - [Recommended Print Media](#)
 - [Handle and Use Print Media](#)
 - [Choose the Right Print Media](#)

Related Topics:

- [Change the Paper Size Settings](#)
- [Paper Handling and Printing Problems](#)

Recommended Print Media

For the best print quality, we recommend using the Brother paper listed in the table.

Brother paper may not be available in all countries.

If Brother paper is not available in your country, we recommend testing various paper types before purchasing large quantities.

Brother paper

| Paper Type | Item |
|-------------------------|---------|
| A4 Plain | BP60PA |
| A4 Glossy Photo | BP71GA4 |
| A4 Inkjet (Matte) | BP60MA |
| 10 x 15 cm Glossy Photo | BP71GP |



Related Information

- [Acceptable Paper and Other Print Media](#)

Handle and Use Print Media

- Store paper in its original packaging and keep it sealed. Keep the paper flat and away from moisture, direct sunlight and heat.
- Avoid touching the shiny (coated) side of photo paper.
- Some envelope sizes require that you set margins in the application. Make sure you do a test print first before printing many envelopes.

IMPORTANT

DO NOT use the following types of paper:

- Damaged, curled, wrinkled, or irregularly shaped

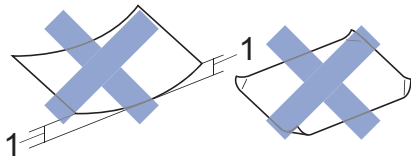

1. **2 mm or greater curl may cause jams to occur.**

- Extremely shiny or highly textured
- Paper that cannot be arranged uniformly when stacked
- Paper made with a short grain

DO NOT use envelopes that:

- Are loosely constructed
- Have windows
- Are embossed (have raised writing on them)
- Have clasps or staples
- Are pre-printed on the inside
- Are self-adhesive
- Have double flaps

Self-adhesive Double flaps

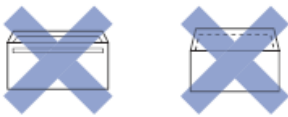

You may experience paper feed problems caused by the thickness, size and flap shape of the envelopes you are using.



Related Information

- [Acceptable Paper and Other Print Media](#)

Choose the Right Print Media

- Paper Type and Paper Size for Each Operation
- Paper Capacity of the Paper Trays
- Paper Weight and Thickness
- Load Cut-Sheet Paper or Photo 2L Paper in the Paper Tray
- Load Photo Paper in the Paper Tray
- Load Envelopes in the Paper Tray
- Load Paper in the Manual Feed Slot

Paper Type and Paper Size for Each Operation

| Paper Type | Paper Size | | Usage | |
|------------|-------------|------------------|-------|---------|
| | | | Copy | Printer |
| Cut-Sheet | A4 | 210 x 297 mm | Yes | Yes |
| | Letter | 215.9 x 279.4 mm | Yes | Yes |
| | Executive | 184.1 x 266.7 mm | - | Yes |
| | A5 | 148 x 210 mm | Yes | Yes |
| | A6 | 105 x 148 mm | - | Yes |
| Cards | Photo | 10 x 15 cm | Yes | Yes |
| | Photo L | 9 x 13 cm | - | Yes |
| | Photo 2L | 13 x 18 cm | - | Yes |
| | Index Card | 13 x 20 cm | - | Yes |
| Envelopes | C5 Envelope | 162 x 229 mm | - | Yes |
| | DL Envelope | 110 x 220 mm | - | Yes |
| | Com-10 | 104.7 x 241.3 mm | - | Yes |
| | Monarch | 98.4 x 190.5 mm | - | Yes |



Related Information

- [Choose the Right Print Media](#)

Related Topics:

- [Load Envelopes in the Paper Tray](#)

Paper Capacity of the Paper Trays

| | Paper Size | Paper Types | No. of sheets |
|------------------|--|--|------------------|
| Paper Tray | A4, Letter, Executive, A5, A6, Envelopes (C5, Com-10, DL, Monarch), Photo (4" x 6" / (10 x 15 cm), Photo 2L (5" x 7" / (13 x 18 cm), Index card (5" x 8" / (13 x 20 cm)) | Plain Paper, Recycled Paper | 150 ¹ |
| | | Inkjet Paper | 20 |
| | | Glossy Paper, Photo | 20 |
| | | Index Card | 30 |
| | | Envelopes | 10 |
| Manual Feed Slot | A4, Letter, Executive, A5, A6, Envelopes (C5, Com-10, DL, Monarch), Photo (4" x 6" / (10 x 15 cm), Photo L (3.5" x 5" / (9 x 13 cm), Photo 2L (5" x 7" / (13 x 18 cm), Index card (5" x 8" / (13 x 20 cm)) | Plain Paper, Inkjet Paper, Glossy Paper, Recycled Paper, Photo, Index Card and Envelopes | 1 |

¹ When using plain paper 80 g/m²



Related Information

- [Choose the Right Print Media](#)

Paper Weight and Thickness

| Paper Type | | Weight | Thickness |
|------------|-----------------------------|----------------------------|-----------------|
| Cut-Sheet | Plain Paper, Recycled Paper | 64 to 120 g/m ² | 0.08 to 0.15 mm |
| | Inkjet Paper | 64 to 200 g/m ² | 0.08 to 0.25 mm |
| | Glossy Paper ^{1 2} | Up to 220 g/m ² | Up to 0.25 mm |
| Cards | Photo Card ^{1 2} | Up to 220 g/m ² | Up to 0.25 mm |
| | Index Card | Up to 120 g/m ² | Up to 0.15 mm |
| Envelopes | | 80 to 95 g/m ² | Up to 0.52 mm |

¹ BP71 260 g/m² paper is specially designed for Brother inkjet machines.

² Up to 300 g/m² for Manual Feed Slot



Related Information

- [Choose the Right Print Media](#)

Related Topics:

- [Paper Handling and Printing Problems](#)

Load Documents

- [Load Documents on the Scanner Glass](#)
- [Unscannable Area](#)

Load Documents on the Scanner Glass

Use the scanner glass to copy or scan one page at a time.

Document Sizes Supported

| | |
|---------|----------------|
| Length: | Up to 297 mm |
| Width: | Up to 215.9 mm |
| Weight: | Up to 2 kg |

1. Lift the document cover.
2. Place the document **face down** in the lower right corner of the scanner glass as shown in the illustration.

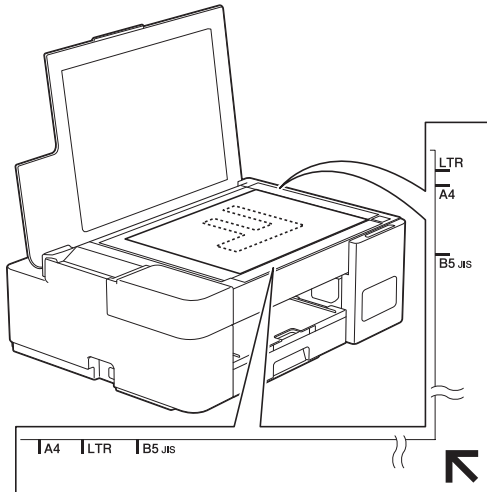

3. Close the document cover.

IMPORTANT

If you are scanning a book or thick document, DO NOT forcefully close or press on the document cover.

✓ Related Information

- [Load Documents](#)

Related Topics:

- [Copy a Document](#)
- [Other Problems](#)

Unscannable Area

The unscannable area of a page depends on the settings in the application you are using. The figures below show the typical unscannable measurements.

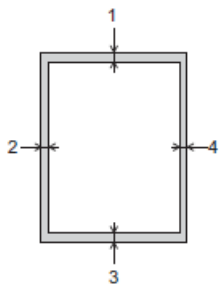

| Usage | Document Size | Top (1) Bottom (3) | Left (2) Right (4) |
|-------|-----------------|-----------------------|-----------------------|
| Copy | All paper sizes | 3 mm | 3 mm |
| Scan | | 1 mm | 1 mm |



Related Information

- [Load Documents](#)

Print

- [Print from Your Computer \(Windows\)](#)
- [Print Using Brother iPrint&Scan \(Windows/Mac\)](#)
- [Print an Email Attachment](#)

Print from Your Computer (Windows)

- [Print a Photo \(Windows\)](#)
- [Print a Document \(Windows\)](#)
- [Cancel a Print Job \(Windows\)](#)
- [Print More Than One Page on a Single Sheet of Paper \(N in 1\) \(Windows\)](#)
- [Print as a Poster \(Windows\)](#)
- [Print on Both Sides of the Paper Manually \(Manual 2-sided Printing\) \(Windows\)](#)
- [Print as a Booklet Manually \(Windows\)](#)
- [Print a Colour Document in Greyscale \(Windows\)](#)
- [Prevent Smudged Printouts and Paper Jams \(Windows\)](#)
- [Use a Preset Print Profile \(Windows\)](#)
- [Change the Default Print Settings \(Windows\)](#)
- [Print Settings \(Windows\)](#)

Print a Photo (Windows)



1. Select the print command in your application.
2. Select **Brother XXX-XXXX Printer** (where XXX-XXXX is the name of your model), and then click the printing properties or preferences button.
The printer driver window appears.
3. Make sure you have loaded the correct media in the paper tray.

IMPORTANT

- For best results, use Brother paper.
- When you print on photo paper, load one extra sheet of the same photo paper in the paper tray.

4. Click the **Basic** tab.
5. Click the **Media Type** drop-down list, and then select the type of paper you are using.

IMPORTANT

To get the best print quality for the settings you have selected, always set the **Media Type** option to match the type of paper you load.

6. Click the **Paper Size** drop-down list, and then select your paper size.
7. Select the **Borderless** checkbox, if needed.
8. For **Colour / Greyscale**, select **Colour**.
9. In the **Orientation** field, select the **Portrait** or **Landscape** option to set the orientation of your printout.



If your application contains a similar setting, we recommend that you set the orientation using the application.

10. Type the number of copies (1-999) you want in the **Copies** field.
11. Change other printer settings, if needed.
12. Click **OK**.
13. Complete your print operation.



Related Information

- [Print from Your Computer \(Windows\)](#)

Related Topics:

- [Print Settings \(Windows\)](#)

Print a Document (Windows)

1. Select the print command in your application.
2. Select **Brother XXX-XXXX Printer** (where XXX-XXXX is the name of your model), and then click the printing properties or preferences button.
The printer driver window appears.
3. Make sure you have loaded the correct size paper in the paper tray.
4. Click the **Basic** tab.
5. Click the **Media Type** drop-down list, and then select the type of paper you are using.

IMPORTANT

To get the best print quality for the settings you have selected, always set the **Media Type** option to match the type of paper you load.

6. Click the **Paper Size** drop-down list, and then select your paper size.
7. For **Colour / Greyscale**, select the **Colour** or **Greyscale** option.
8. In the **Orientation** field, select the **Portrait** or **Landscape** option to set the orientation of your printout.



If your application contains a similar setting, we recommend that you set the orientation using the application.

9. Type the number of copies (1-999) you want in the **Copies** field.
10. To print multiple pages on a single sheet of paper or print one page of your document on multiple sheets, click the **Multiple Page** drop-down list, and then select your options.
11. Change other printer settings, if needed.
12. Click **OK**.
13. Complete your print operation.



Related Information

- [Print from Your Computer \(Windows\)](#)

Related Topics:

- [Print Settings \(Windows\)](#)

Cancel a Print Job (Windows)

If a print job was sent to the print queue and did not print, or was sent to the print queue in error, you may have to delete it to allow subsequent jobs to print.

1. Double-click the printer icon  in the task tray.
2. Select the print job you want to cancel.
3. Click the **Document** menu.
4. Select **Cancel**.
5. Click **Yes**.



Related Information

- [Print from Your Computer \(Windows\)](#)

Related Topics:

- [Monitor Machine Status from Your Computer \(Windows\)](#)
-

Print More Than One Page on a Single Sheet of Paper (N in 1) (Windows)



1. Select the print command in your application.
2. Select **Brother XXX-XXXX Printer** (where XXX-XXXX is the name of your model), and then click the printing properties or preferences button.
The printer driver window appears.
3. Click the **Basic** tab.
4. In the **Orientation** field, select the **Portrait** or **Landscape** option to set the orientation of your printout.



If your application contains a similar setting, we recommend that you set the orientation using the application.

5. Click the **Multiple Page** drop-down list, and then select the **2 in 1**, **4 in 1**, **9 in 1**, or **16 in 1** option.
6. Click the **Page Order** drop-down list, and then select your page order.
7. Click the **Border Line** drop-down list, and then select your border line type.
8. Change other printer settings, if needed.
9. Click **OK**, and then complete your print operation.



Related Information

- [Print from Your Computer \(Windows\)](#)

Related Topics:

- [Print Settings \(Windows\)](#)

Print as a Poster (Windows)

Enlarge your print size and print the document in poster mode.

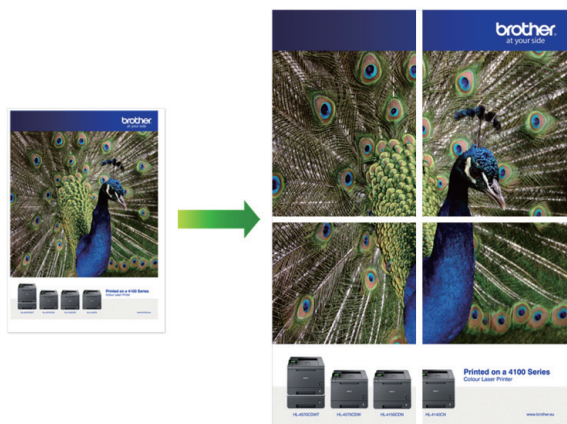

1. Select the print command in your application.
2. Select **Brother XXX-XXXX Printer** (where XXX-XXXX is the name of your model), and then click the printing properties or preferences button.
The printer driver window appears.
3. Click the **Basic** tab.
4. Click the **Multiple Page** drop-down list, and then select the **1 in 2x2 Pages** or **1 in 3x3 Pages** option.
5. Change other printer settings, if needed.
6. Click **OK**.
7. Complete your print operation.

✓ Related Information

- [Print from Your Computer \(Windows\)](#)

Related Topics:

- [Print Settings \(Windows\)](#)

Print on Both Sides of the Paper Manually (Manual 2-sided Printing) (Windows)

The machine prints all the odd-numbered pages on one side of the paper first. Then, a pop-up message on your computer screen instructs you to reload the odd pages into the machine so it can print the even-numbered pages.



- Before reloading the paper, fan and straighten it to avoid paper jams.
- Very thin or thick paper is not recommended.
- If the paper is thin, it may wrinkle.
- The 2-sided printing function may not be suitable for all types of documents and images. If you experience repeat paper jams or poor print quality during 2-sided printing, we recommend using 1-sided printing.

1. Select the print command in your application.
2. Select **Brother XXX-XXXX Printer** (where XXX-XXXX is the name of your model), and then click the printing properties or preferences button.
The printer driver window appears.
3. Click the **Basic** tab.
4. In the **Orientation** field, select the **Portrait** or **Landscape** option to set the orientation of your printout.



If your application contains a similar setting, we recommend that you set the orientation using the application.

5. Click the **2-sided / Booklet** drop-down list, and then select **2-sided (Manual)**.
6. Click the **2-sided Settings** button.
7. Select one of the options from the **2-sided Type** menu.

When 2-sided is selected, four types of 2-sided binding are available for each orientation:

| Option for Portrait | Description |
|--------------------------|-------------|
| Long Edge (Left) | |
| Long Edge (Right) | |

| Option for Portrait | Description |
|---------------------|-------------|
|---------------------|-------------|

Short Edge (Top)

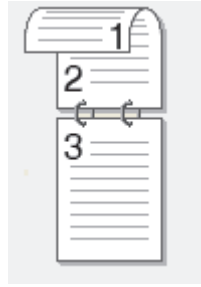

Short Edge (Bottom)

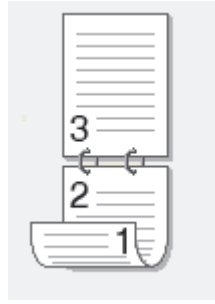

| Option for Landscape | Description |
|----------------------|-------------|
|----------------------|-------------|

Long Edge (Top)



Long Edge (Bottom)

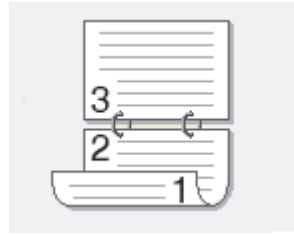

Short Edge (Right)

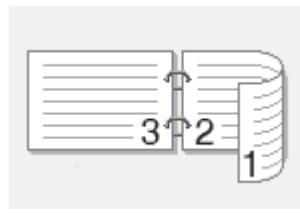

Short Edge (Left)

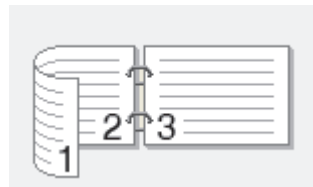

8. Select the **Binding Offset** checkbox to specify the offset for binding in inches or millimetres.
9. Click **OK** to return to the printer driver window.
10. Change other printer settings, if needed.



The Borderless feature is not available when using this option.

11. Click **OK**, and then start printing.

12. Click **OK** to print the first side of the pages.

The machine prints all the odd numbered pages first. Then, the printing stops and a pop-up message on your computer screen instructs you to reload the paper.

13. Reload the paper.

14. Click **OK**.

The even numbered pages will be printed.

If the paper is not feeding correctly, it may be curled. Remove the paper, straighten it, and put it back in the paper tray.



Related Information

- [Print from Your Computer \(Windows\)](#)

Related Topics:

- [Print as a Booklet Manually \(Windows\)](#)
-

Print as a Booklet Manually (Windows)

Use this option to print a document in booklet format using 2-sided printing. The document's pages will be arranged according to the correct page number and will allow you to fold at the centre of the print output without having to change the order of the printed pages.

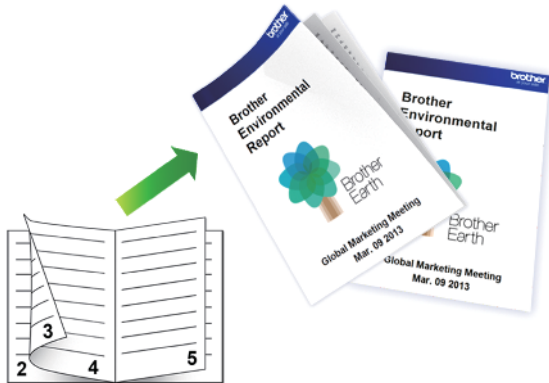

- Before reloading the paper, fan and straighten it to avoid paper jams.
- Very thin or thick paper is not recommended.
- If the paper is thin, it may wrinkle.
- The 2-sided printing function may not be suitable for all types of documents and images. If you experience repeat paper jams or poor print quality during 2-sided printing, we recommend using 1-sided printing.

1. Select the print command in your application.
2. Select **Brother XXX-XXXX Printer** (where XXX-XXXX is the name of your model), and then click the printing properties or preferences button.
The printer driver window appears.
3. Click the **Basic** tab.
4. In the **Orientation** field, select the **Portrait** or **Landscape** option to set the orientation of your printout.



If your application contains a similar setting, we recommend that you set the orientation using the application.

5. Click the **2-sided / Booklet** drop-down list, and then select the **Booklet (Manual)** option.
6. Click the **2-sided Settings** button.
7. Select one of the options from the **2-sided Type** menu.

There are two types of 2-sided binding directions available for each orientation:

| Option for Portrait | Description |
|----------------------|-------------|
| Left Binding | |
| Right Binding | |

| Option for Landscape | Description |
|----------------------|-------------|
|----------------------|-------------|

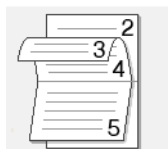

Top Binding

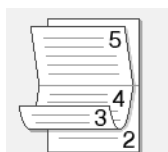

Bottom Binding



8. Select one of the options from the **Booklet Printing Method** menu.

| Option | Description |
|--------------------------|--|
| All Pages at Once | Every page is printed in booklet format (four pages to every piece of paper, two pages per side). Fold your printout in the middle to create the booklet.  |
| Divide into Sets | This option prints the whole booklet in smaller individual booklet sets, allowing you to fold at the centre of the smaller individual booklet sets without having to change the order of the printed pages. You can specify the number of sheets in each smaller booklet set (from 1-15). This option can be helpful when folding a printed booklet that has a large number of pages.  |

9. Select the **Binding Offset** checkbox to specify the offset for binding in inches or millimetres.

10. Click **OK** to return to the printer driver window.

11. Change other printer settings, if needed.



The Borderless feature is not available when using this option.

12. Click **OK**, and then start printing.

13. Click **OK** to print the first side of the pages.

The machine prints all the odd numbered pages first. Then, the printing stops and a pop-up message on your computer screen instructs you to reload the paper.

14. Reload the paper.

15. Click **OK**.

The even numbered pages are printed.

If the paper is not feeding correctly, it may be curled. Remove the paper, straighten it, and put it back in the paper tray.



Related Information

- [Print from Your Computer \(Windows\)](#)

Related Topics:

- [Print on Both Sides of the Paper Manually \(Manual 2-sided Printing\) \(Windows\)](#)

Print a Colour Document in Greyscale (Windows)

Greyscale mode makes the print processing speed faster than colour mode. If your document contains colour, selecting Greyscale mode prints your document in 256 levels of greyscale.

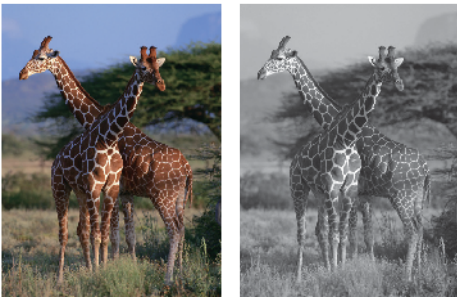

1. Select the print command in your application.
2. Select **Brother XXX-XXXX Printer** (where XXX-XXXX is the name of your model), and then click the printing properties or preferences button.
The printer driver window appears.
3. Click the **Basic** tab.
4. For **Colour / Greyscale**, select **Greyscale**.
5. Change other printer settings, if needed.
6. Click **OK**.
7. Complete your print operation.



Related Information

- [Print from Your Computer \(Windows\)](#)

Prevent Smudged Printouts and Paper Jams (Windows)

Some types of print media may need more drying time. Change the **Reduce Smudge** option if you have problems with smudged printouts or paper jams.

1. Select the print command in your application.
2. Select **Brother XXX-XXXX Printer** (where XXX-XXXX is the name of your model), and then click the printing properties or preferences button.

The printer driver window appears.

3. Click the **Advanced** tab.
4. Click the **Other Print Options** button.
5. Select the **Reduce Smudge** option on the left side of the screen.
6. Select one of the following options:

| Media Type | Option | Description |
|--------------|----------|---|
| Plain Paper | Off / On | Select Off to print at normal speed, using a standard amount of ink. Select On to print at a slower speed, using less ink. Printouts may be lighter than they appear in Print Preview. |
| Glossy Paper | Off / On | Select Off to print at normal speed, using a standard amount of ink. Select On to print at a slower speed, using less ink. Printouts may be lighter than they appear in Print Preview. |

7. Click **OK** to return to the printer driver window.
8. Click **OK**.
9. Complete your print operation.



Related Information

- [Print from Your Computer \(Windows\)](#)

Related Topics:

- [Paper Handling and Printing Problems](#)
- [Change the Print Options to Improve Your Print Results](#)

Use a Preset Print Profile (Windows)

Print Profiles are presets designed to give you quick access to frequently-used printing configurations.

1. Select the print command in your application.
2. Select **Brother XXX-XXXX Printer** (where XXX-XXXX is the name of your model), and then click the printing properties or preferences button.
The printer driver window appears.
3. Click the **Print Profiles** tab.

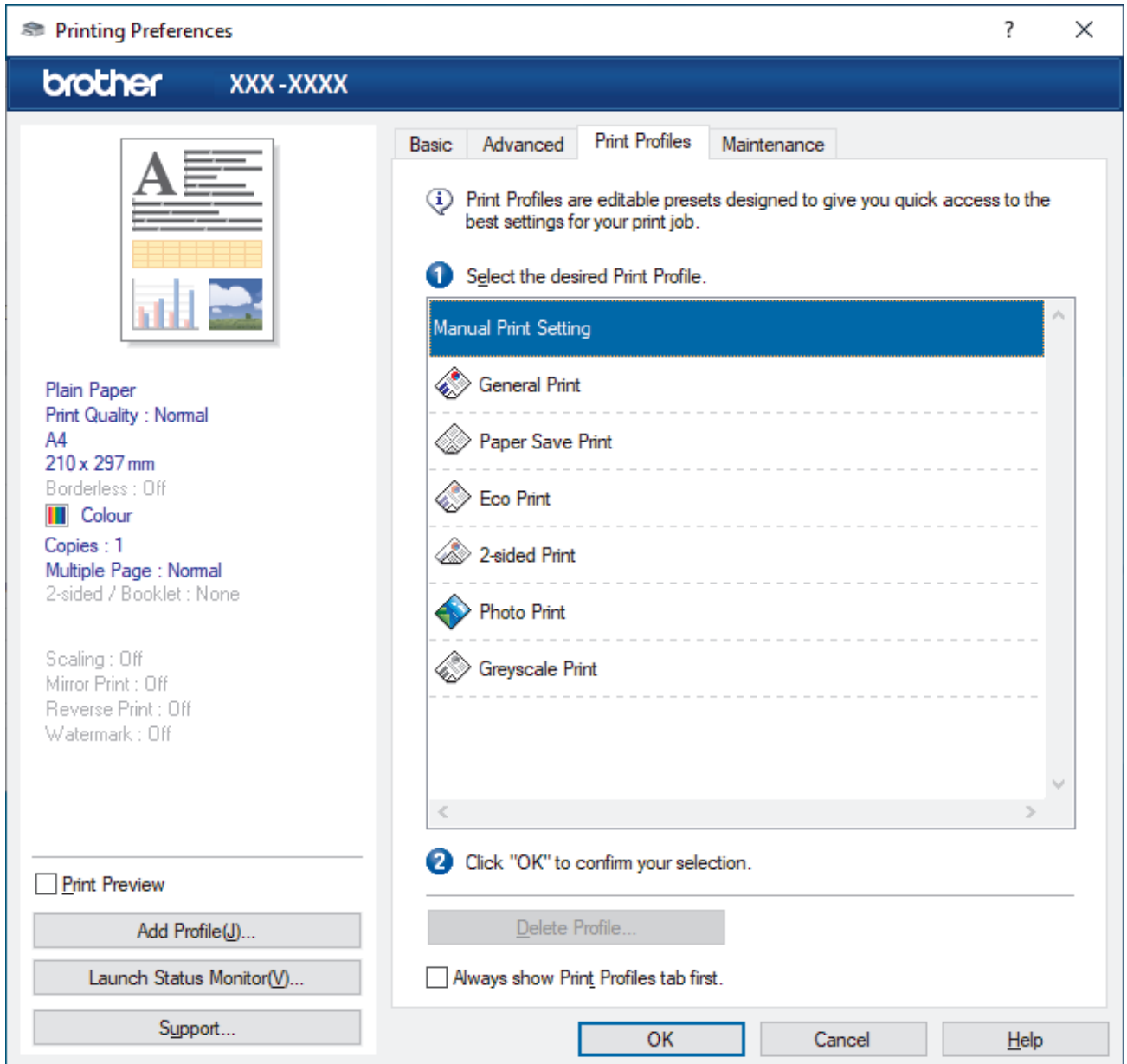

4. Select your profile from the print profile list.
The profile settings are shown on the left side of the printer driver window.
5. Do one of the following:
 - If the settings are correct for your print job, click **OK**.
 - To change the settings, go back to the **Basic** or **Advanced** tab, change settings, and then click **OK**.



To display the **Print Profiles** tab at the front of the window the next time you print, select the **Always show Print Profiles tab first**. checkbox.



Related Information

- [Print from Your Computer \(Windows\)](#)
 - [Create or Delete Your Print Profile \(Windows\)](#)

Related Topics:

- [Print Settings \(Windows\)](#)
-

Create or Delete Your Print Profile (Windows)

Add up to 20 new print profiles with customised settings.

1. Select the print command in your application.
2. Select **Brother XXX-XXXX Printer** (where XXX-XXXX is the name of your model), and then click the printing properties or preferences button.

The printer driver window appears.

3. Do one of the following:

To create a new print profile:

- a. Click the **Basic** tab and the **Advanced** tab, and configure the print settings you want for the new Print Profile.
 - b. Click the **Print Profiles** tab.
 - c. Click **Add Profile**.
- The **Add Profile** dialog box appears.
- d. Type the new profile name in the **Name** field.
 - e. Click the icon you want to use to represent this profile from the icon list.
 - f. Click **OK**.

The new Print Profile name is added to the list in the **Print Profiles** tab.

To delete a print profile that you created:

- a. Click the **Print Profiles** tab.
 - b. Click **Delete Profile**.
- The **Delete Profile** dialog box appears.
- c. Select the profile you want to delete.
 - d. Click **Delete**.
 - e. Click **Yes**.
 - f. Click **Close**.





Related Information

- [Use a Preset Print Profile \(Windows\)](#)

Change the Default Print Settings (Windows)

When you change an application's print settings, the changes only apply to documents printed with that application. To change print settings for all Windows applications, you must configure the printer driver properties.

1. Do one of the following:
 - For Windows 10, Windows Server 2016, and Windows Server 2019
Click  > **Windows System** > **Control Panel**. In the **Hardware and Sound** group, click **View devices and printers**.
 - For Windows 8.1
Move your mouse to the lower right corner of your desktop. When the menu bar appears, click **Settings**, and then click **Control Panel**. In the **Hardware and Sound** group, click **View devices and printers**.
 - For Windows Server 2012 R2
Click **Control Panel** on the **Start** screen. In the **Hardware** group, click **View devices and printers**.
 - For Windows Server 2012
Move your mouse to the lower right corner of your desktop. When the menu bar appears, click **Settings**, and then click **Control Panel**. In the **Hardware** group, click **View devices and printers**.
 - For Windows 7 and Windows Server 2008 R2
Click  (**Start**) > **Devices and Printers**.
 - For Windows Server 2008
Click  (**Start**) > **Control Panel** > **Hardware and Sound** > **Printers**.
2. Right-click the **Brother XXX-XXXX Printer** icon (where XXX-XXXX is the name of your model), and then select **Printer properties**. If printer driver options appear, select your printer driver.
The printer properties dialog box appears.
3. Click the **General** tab, and then click the **Printing Preferences...** or **Preferences...** button.
The printer driver dialog box appears.
4. Select the print settings you want to use as defaults for all of your Windows programs.
5. Click **OK**.
6. Close the printer properties dialog box.



Related Information

- [Print from Your Computer \(Windows\)](#)

Related Topics:

- [Print Settings \(Windows\)](#)

Print Settings (Windows)

- >> Basic Tab
- >> Advanced Tab

Basic Tab

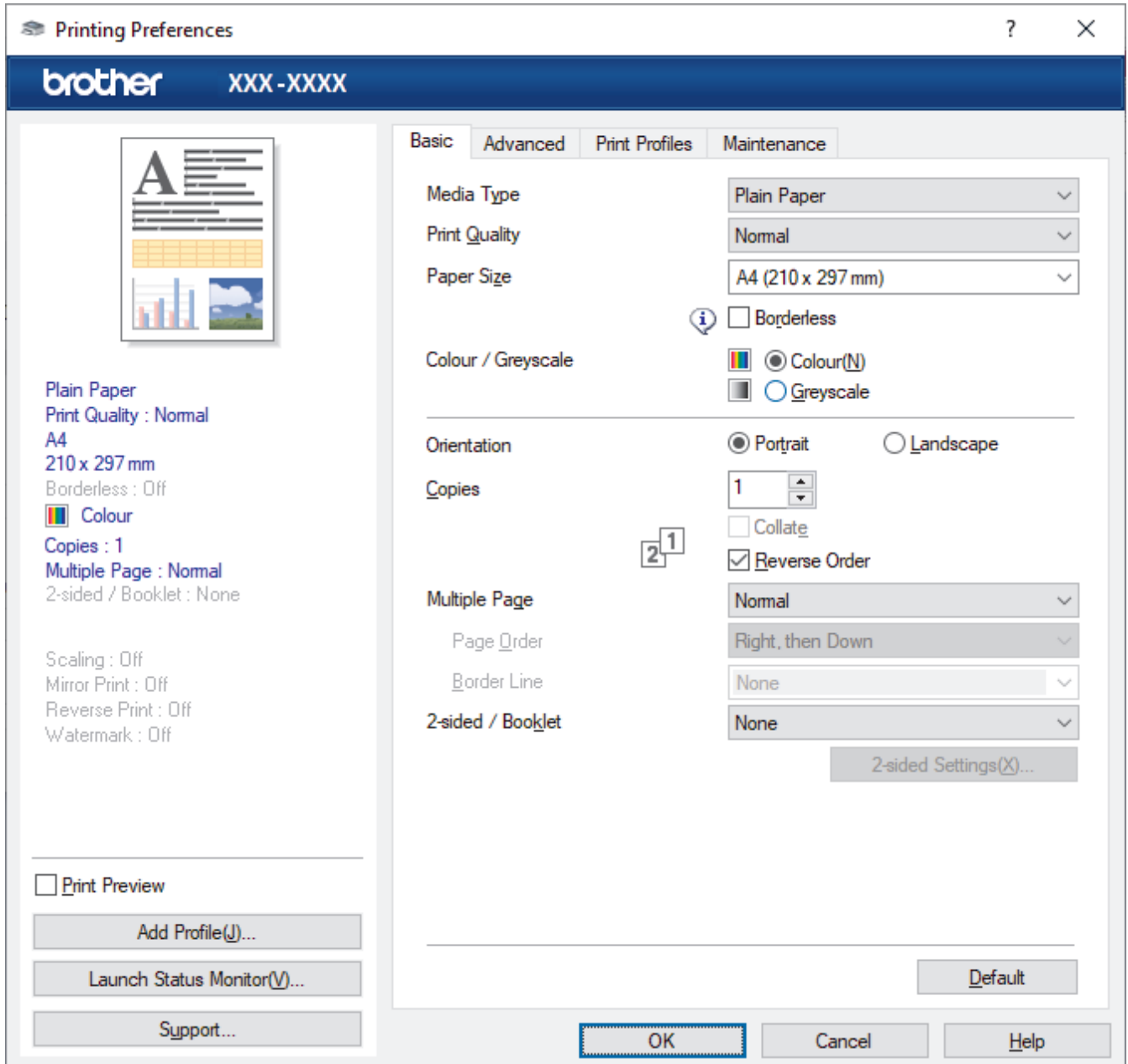

1. Media Type

Select the media type you want to use. To achieve the best print results, the machine automatically adjusts its print settings according to the selected media type.

2. Print Quality

Select the print quality you want. Because print quality and speed are related, the higher the quality, the longer it will take to print the document.

3. Paper Size

Select the paper size you want to use. You can either choose from standard paper sizes or create a custom paper size.

Borderless

Select this option to print photos without borders. Because the image data is created slightly larger than the paper size you are using, this will cause some cropping of the photo edges.

You may not be able to select the Borderless option for some combinations of media type and quality, or from some applications.

4. Colour / Greyscale

Select colour or greyscale printing. The print speed is faster in greyscale mode than it is in colour mode. If your document contains colour and you select greyscale mode, your document will be printed using 256 levels of greyscale.

5. Orientation

Select the orientation (portrait or landscape) of your printout.

If your application contains a similar setting, we recommend that you set the orientation using the application.

6. Copies

Type the number of copies (1-999) that you want to print in this field.

Collate

Select this option to print sets of multi-page documents in the original page order. When this option is selected, one complete copy of your document will print, and then reprint according to the number of copies you choose. If this option is not selected, then each page will print according to the number of copies chosen before the next page of the document is printed.

Reverse Order

Select this option to print your document in reverse order. The last page of your document will be printed first.

7. Multiple Page

Select this option to print multiple pages on a single sheet of paper, or print one page of your document on multiple sheets.

Page Order

Select the page order when printing multiple pages on a single sheet of paper.

Border Line

Select the type of border to use when printing multiple pages on a single sheet of paper.

8. 2-sided / Booklet

Select this option to print on both sides of the paper, or print a document in booklet format using 2-sided printing.

2-sided Settings button

Click this button to select the type of 2-sided binding. Four types of 2-sided bindings are available for each orientation.

Advanced Tab

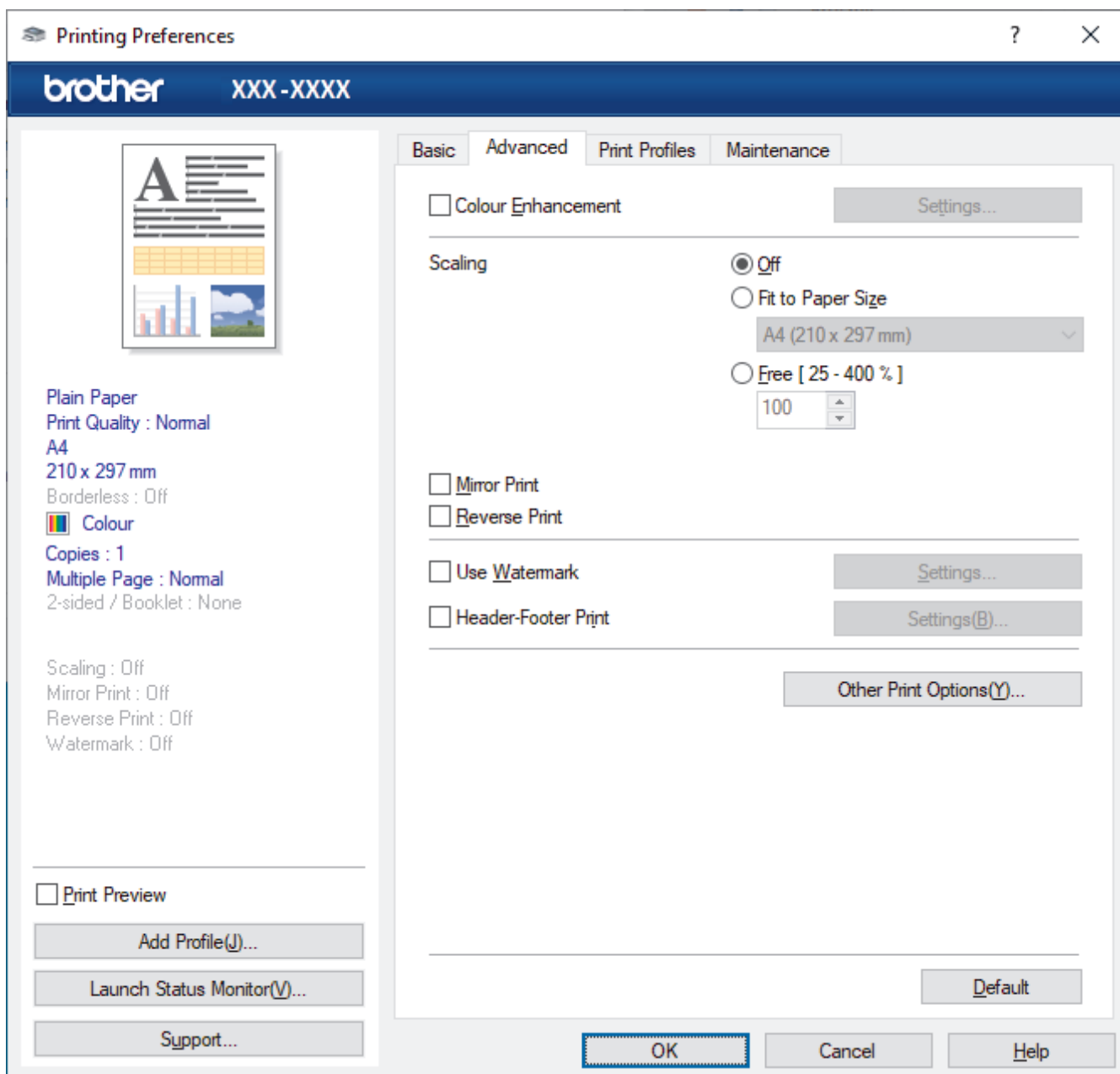

1. Colour Enhancement

Select this option to use the Colour Enhancement feature. This feature analyses your image to improve its sharpness, white balance and colour density. This process may take several minutes depending on the image size and your computer's specifications.

2. Scaling

Select these options to enlarge or reduce the size of the pages in your document.

Fit to Paper Size

Select this option to enlarge or reduce the document pages to fit a specified paper size. When you select this option, select the paper size you want from the drop-down list.

Free [25 - 400 %]

Select this option to enlarge or reduce the document pages manually. When you select this option, type a value into the field.

3. Mirror Print

Select this option to reverse the printed image on the page horizontally from left to right.

4. Reverse Print

Select this option to rotate the printed image 180 degrees.

5. Use Watermark

Select this option to print a logo or text on your document as a watermark. Select one of the preset watermarks, add a new watermark, or use an image file you have created.

6. Header-Footer Print

Select this option to print the date, time and PC login user name on the document.

7. Other Print Options button

Advanced Colour Settings

Select the method that the machine uses to arrange dots to express halftones.

The printout colour can be adjusted to achieve the closest match to what appears on your computer screen.

Advanced Quality Settings

Select this option to print your documents at the highest quality.

Reduce Smudge

Some types of print media may need more drying time. Change this option if you have problems with smudged printouts or paper jams.

Retrieve Printer's Colour Data

Select this option to optimise the print quality using the machine's factory settings, which are set specifically for your Brother machine. Use this option when you have replaced the machine or changed the machine's network address.

Print Archive

Select this option to save the print data as a PDF file to your computer.

Reduce Ink Density

Select this feature to conserve ink. Printouts use less ink and are lighter than they appear in Print Preview.



Related Information

- [Print from Your Computer \(Windows\)](#)

Related Topics:

- [Error and Maintenance LED Indications](#)
 - [Paper Handling and Printing Problems](#)
 - [Print a Photo \(Windows\)](#)
 - [Print a Document \(Windows\)](#)
 - [Print More Than One Page on a Single Sheet of Paper \(N in 1\) \(Windows\)](#)
 - [Print as a Poster \(Windows\)](#)
 - [Use a Preset Print Profile \(Windows\)](#)
 - [Change the Default Print Settings \(Windows\)](#)
 - [Change the Print Options to Improve Your Print Results](#)
-

Print Using Brother iPrint&Scan (Windows/Mac)

- [Print Photos or Documents Using Brother iPrint&Scan \(Windows/Mac\)](#)
- [Print More Than One Page on a Single Sheet of Paper Using Brother iPrint&Scan \(N in 1\) \(Windows/Mac\)](#)
- [Print a Colour Document in Greyscale Using Brother iPrint&Scan \(Windows/Mac\)](#)

Print Photos or Documents Using Brother iPrint&Scan (Windows/Mac)



1. Make sure you have loaded the correct media in the paper tray.

IMPORTANT

For photo printing:

- For best results, use Brother paper.
- When you print on photo paper, load one extra sheet of the same photo paper in the paper tray.

2. Start Brother iPrint&Scan.

- Windows

Launch  (Brother iPrint&Scan).

- Mac

In the **Finder** menu bar, click **Go > Applications**, and then double-click the iPrint&Scan icon.

The Brother iPrint&Scan screen appears.

3. If your Brother machine is not selected, click the **Select your Machine** button, and then select your model name from the list. Click **OK**.
4. Click **Print**.
5. Do one of the following:
 - Windows
Click **Photo** or **Document**.
 - Mac
Click **Photo** or **PDF**.
6. Select the file you want to print, and then do one of the following:
 - Windows
Click **Next**.
 - Mac
Click **Open**.

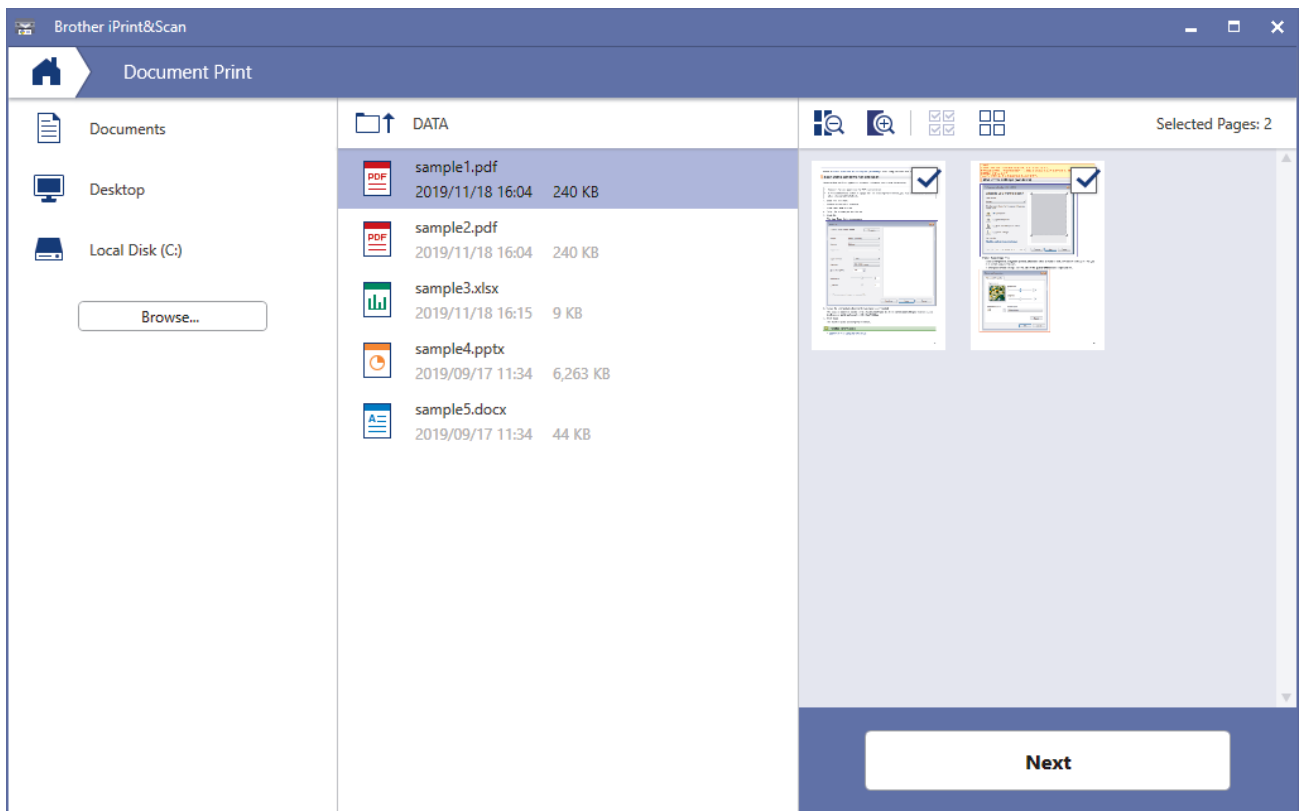

- The actual screen may differ depending on the version of the application.
- Use the latest application. See *Related Information*.
- When printing documents with many pages, you can also select the pages you want to print.

7. Change other printer settings, if needed.

8. Click **Print**.

IMPORTANT

For photo printing:

To get the best print quality for the settings you have selected, always set the **Media Type** option to match the type of paper you load.



Related Information

- [Print Using Brother iPrint&Scan \(Windows/Mac\)](#)

Related Topics:

- [Brother iPrint&Scan Overview for Windows and Mac](#)

Print More Than One Page on a Single Sheet of Paper Using Brother iPrint&Scan (N in 1) (Windows/Mac)



1. Launch  (**Brother iPrint&Scan**).

The Brother iPrint&Scan screen appears.

2. If your Brother machine is not selected, click the **Select your Machine** button, and then select your model name from the list. Click **OK**.
3. Click **Print**.
4. Do one of the following:
 - Windows
Click **Document**.
 - Mac
Click **PDF**.
5. Select the file you want to print, and then do one of the following:
 - Windows
Click **Next**.
 - Mac
Click **Open**.



When printing documents with many pages, you can also select the pages you want to print.

6. Click the **Layout** drop-down list, and then select the number of pages to print on each sheet.
7. Change other printer settings, if needed.
8. Click **Print**.





Related Information

- [Print Using Brother iPrint&Scan \(Windows/Mac\)](#)

Print a Colour Document in Greyscale Using Brother iPrint&Scan (Windows/Mac)

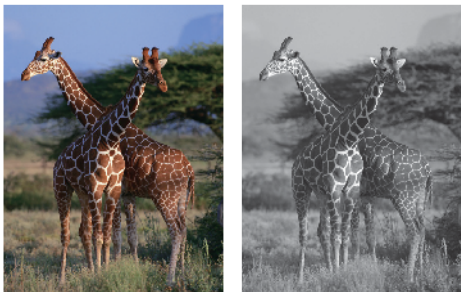
Greyscale mode makes the print processing speed faster than colour mode. If your document contains colour, selecting Greyscale mode prints your document in 256 levels of greyscale.



1. Start Brother iPrint&Scan.
 - Windows
Launch  (Brother iPrint&Scan).
 - Mac
In the **Finder** menu bar, click **Go > Applications**, and then double-click the iPrint&Scan icon.
The Brother iPrint&Scan screen appears.
2. If your Brother machine is not selected, click the **Select your Machine** button, and then select your model name from the list. Click **OK**.
3. Click **Print**.
4. Do one of the following:
 - Windows
Click **Photo** or **Document**.
 - Mac
Click **Photo** or **PDF**.
5. Select the file you want to print, and then do one of the following:
 - Windows
Click **Next**.
 - Mac
Click **Open**.



When printing documents with many pages, you can also select the pages you want to print.

6. Click the **Colour / Mono** drop-down list, and then select the **Mono** option.
7. Change other printer settings, if needed.
8. Click **Print**.



Related Information

- [Print Using Brother iPrint&Scan \(Windows/Mac\)](#)

Print an Email Attachment

Related Models: DCP-T420W/DCP-T425W/DCP-T426W

You can print files by emailing them to your Brother machine.

- You can attach up to 10 documents, 20 MB in total, to an email.
- This feature supports the following formats:
 - Document files: PDF, TXT, and Microsoft Office files
 - Image files: JPEG, BMP, GIF, PNG, and TIFF
- The machine prints both the email content and attachments by default. To print only email attachments, change the settings as necessary.

1. Start Brother iPrint&Scan.

- Windows

Launch  (**Brother iPrint&Scan**).

- Mac

In the **Finder** menu bar, click **Go > Applications**, and then double-click the iPrint&Scan icon.

The Brother iPrint&Scan screen appears.

2. If your Brother machine is not selected, click the **Select your Machine** button, and then select your model name from the list. Click **OK**.

3. Click  (**Machine Settings**) to configure the settings.

4. If required, type the password in the **Login** field, and then click **Login**.



The default password to manage this machine's settings is located on the back of the machine and marked "Pwd".

5. Go to the navigation menu, and then click **Online Functions > Online Functions Settings**.



Start from , if the navigation menu is not shown on the left side of the screen.

6. Click the **I accept the terms and conditions** button.

The machine prints the Instruction Sheet.

7. Send your email to the email address included on the sheet. The machine prints the email attachments.



To change the settings, including email address and printer settings, click the **Advanced Settings web page** link.



Related Information

- [Print](#)

Related Topics:

- [Access Web Based Management](#)

Scan

- [Scan Using the Buttons on Your Brother Machine](#)
- [Scan Using Brother iPrint&Scan \(Windows/Mac\)](#)
- [Scan from Your Computer \(Windows\)](#)
- [Scan from Your Computer \(Mac\)](#)



Scan Using the Buttons on Your Brother Machine

- [Scan Using the Buttons on Your Brother Machine](#)
- [Scan to an Editable Text File Using OCR](#)
- [Save Scanned Data as an Email Attachment](#)
- [Web Services for Scanning on Your Network \(Windows 7, Windows 8.1, and Windows 10\)](#)

Scan Using the Buttons on Your Brother Machine

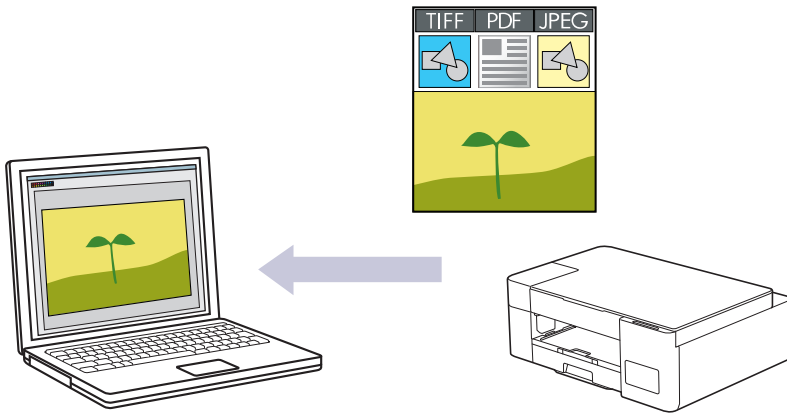

Send scanned photos or graphics directly to your computer.



1. Before scanning for the first time, do the following:
 - a. Start Brother iPrint&Scan.
 - Windows
Launch  (Brother iPrint&Scan).
 - Mac
In the **Finder** menu bar, click **Go > Applications**, and then double-click the iPrint&Scan icon.
The Brother iPrint&Scan screen appears.
 - b. If your Brother machine is not selected, click the **Select your Machine** button, and then select your model name from the list. Click **OK**.
 - c. Click  (**Machine Settings**) to configure the settings.
 - d. If required, type the password in the **Login** field, and then click **Login**.

 The default password to manage this machine's settings is located on the back of the machine and marked "Pwd".

- e. Go to the navigation menu, and then click **Scan > Scan to PC**.

 Start from , if the navigation menu is not shown on the left side of the screen.

- f. Select the scan type you want to use from the **Scan to** drop-down list.
 - g. (DCP-T420W/DCP-T425W/DCP-T426W) Select the computer name where you want to send data from the **PC Name** drop-down list.
 - h. Click **Submit**.
2. Load your document.
 3. Press **Mono Start** and **Colour Start** simultaneously.

If you are requested to select a scanning application, select Brother iPrint&Scan from the list.

Related Information

- [Scan Using the Buttons on Your Brother Machine](#)
 - [Change Scan Settings Using Brother iPrint&Scan](#)

Related Topics:

- [Access Web Based Management](#)
-

Change Scan Settings Using Brother iPrint&Scan

Brother iPrint&Scan allows you to change the machine's Scan Button settings.

1. Start Brother iPrint&Scan.

- Windows

Launch  (Brother iPrint&Scan).

- Mac

In the **Finder** menu bar, click **Go > Applications**, and then double-click the iPrint&Scan icon.

The Brother iPrint&Scan screen appears.

2. If your Brother machine is not selected, click the **Select your Machine** button, and then select your model name from the list. Click **OK**.
3. Click the **Machine Scan Settings** button, and then follow the on-screen instructions to change the scan settings, such as document size, colour, and resolution.



Related Information

- [Scan Using the Buttons on Your Brother Machine](#)

Scan to an Editable Text File Using OCR

Your machine can convert characters in a scanned document to text using optical character recognition (OCR) technology. You can edit this text using your preferred text-editing application.

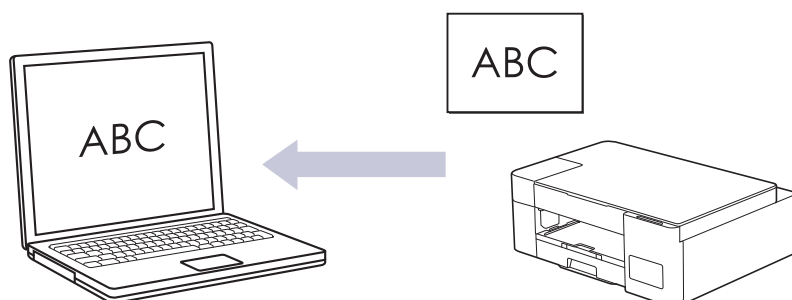

The Scan to OCR feature is available for certain languages.

1. Start Brother iPrint&Scan.
 - Windows
Launch  (**Brother iPrint&Scan**).
 - Mac
In the **Finder** menu bar, click **Go > Applications**, and then double-click the iPrint&Scan icon.
The Brother iPrint&Scan screen appears.
2. Click **Machine Scan Settings**.
3. Click **OCR**.
4. Configure the scan settings, and then click **OK**.
5. Do one of the following:
 - Windows
Click **Close**.
 - Mac
Click **OK**.
6. Load your document.
7. Press **Mono Start** and **Colour Start** simultaneously.

Related Information

- [Scan Using the Buttons on Your Brother Machine](#)

Related Topics:

- [Scan Using the Buttons on Your Brother Machine](#)

Save Scanned Data as an Email Attachment

Send the scanned data from your machine to your email application as an attachment.

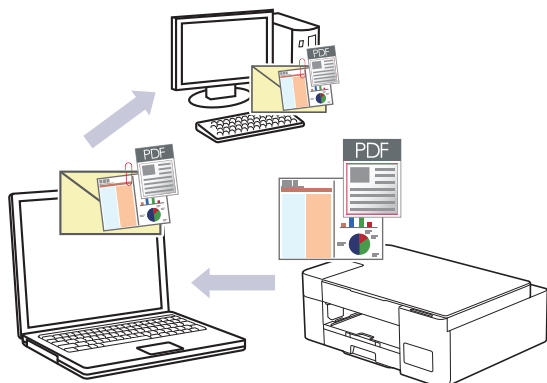

To scan to email using the machine's Scan Button, make sure you select one of these applications in Brother iPrint&Scan:

- Windows: Microsoft Outlook
- Mac: Apple Mail

For other applications and Webmail services, use the Scan to Image or Scan to File feature to scan a document, and then attach the scanned file to an email message.

1. Start Brother iPrint&Scan.
 - Windows
Launch  (Brother iPrint&Scan).
 - Mac
In the **Finder** menu bar, click **Go > Applications**, and then double-click the iPrint&Scan icon.
The Brother iPrint&Scan screen appears.
2. Click **Machine Scan Settings**.
3. Click **E-mail**.
4. Configure the scan settings, and then click **OK**.
5. Do one of the following:
 - Windows
Click **Close**.
 - Mac
Click **OK**.
6. Load your document.
7. Press **Mono Start** and **Colour Start** simultaneously.



Related Information

- [Scan Using the Buttons on Your Brother Machine](#)

Related Topics:

- [Scan Using the Buttons on Your Brother Machine](#)

Web Services for Scanning on Your Network (Windows 7, Windows 8.1, and Windows 10)

Related Models: DCP-T420W/DCP-T425W/DCP-T426W

The Web Services protocol enables Windows 7, Windows 8.1 and Windows 10 users to scan using a Brother machine on the network. You must install the driver via Web Services.

- [Use Web Services to Install Drivers Used for Scanning \(Windows 7, Windows 8.1, and Windows 10\)](#)
- [Scan Using Web Services from Your Machine \(Windows 7, Windows 8.1, and Windows 10\)](#)
- [Configure Scan Settings for Web Services](#)

Use Web Services to Install Drivers Used for Scanning (Windows 7, Windows 8.1, and Windows 10)

Related Models: DCP-T420W/DCP-T425W/DCP-T426W

- Make sure you have installed the correct software and drivers for your machine.
- Verify that the host computer and the Brother machine are on the same subnet, or that the router is correctly configured to pass data between the two devices.
- You must configure the IP address on your Brother machine before you configure this setting.

1. Do one of the following:

- Windows 10

Click  > **Windows System** > **Control Panel**. In the **Hardware and Sound** group, click **Add a device**.

- Windows 8.1

Move your mouse to the lower right corner of your desktop. When the menu bar appears, click **Settings** > **Change PC settings** > **PC and devices** > **Devices** > **Add a device**.

The machine's Web Services Name appears.

- Windows 7

Click  (**Start**) > **Control Panel** > **Network and Internet** > **View network computers and devices**.

The machine's Web Services Name appears with the printer icon.

Right-click the machine you want to install.



- The Web Services Name for the Brother machine is your model name and the MAC Address (Ethernet Address) of your machine (for example, Brother XXX-XXXX (where XXX-XXXX is the name of your model) [XXXXXXXXXXXX] (MAC Address / Ethernet Address)).

- Windows 8.1/Windows 10

Move your mouse over the machine name to display the machine's information.

2. Do one of the following:

- Windows 8.1/Windows 10

Select the machine you want to install, and then follow the on-screen instructions.

- Windows 7

Click **Install** in the displayed menu.



To uninstall drivers, click **Uninstall** or  (**Remove device**).



Related Information



- [Web Services for Scanning on Your Network \(Windows 7, Windows 8.1, and Windows 10\)](#)

Scan Using Web Services from Your Machine (Windows 7, Windows 8.1, and Windows 10)

Related Models: DCP-T420W/DCP-T425W/DCP-T426W

If you have installed the driver for scanning via Web Services, you can access the Web Services scanning menu using Web Based Management.

If the insufficient memory error occurs, select a smaller size in the **Paper size** setting or a lower resolution in the **Resolution (DPI)** setting.

1. Launch  (**Brother iPrint&Scan**).
The Brother iPrint&Scan screen appears.
2. If your Brother machine is not selected, click the **Select your Machine** button, and then select your model name from the list. Click **OK**.
3. Click  (**Machine Settings**) to configure the settings.
4. If required, type the password in the **Login** field, and then click **Login**.



The default password to manage this machine's settings is located on the back of the machine and marked "Pwd".

5. Go to the navigation menu, and then click **Scan > Scan to PC**.



Start from , if the navigation menu is not shown on the left side of the screen.

6. Select the **WS Scan** option from the **Scan to** drop-down list.
7. Select the computer name where you want to send data from the **PC Name** drop-down list.
8. Click **Submit**.
9. Load your document.
10. Press **Mono Start** and **Colour Start** simultaneously.



Related Information



- [Web Services for Scanning on Your Network \(Windows 7, Windows 8.1, and Windows 10\)](#)

Related Topics:

- [Change Scan Settings Using Brother iPrint&Scan](#)
- [Access Web Based Management](#)

Configure Scan Settings for Web Services

Related Models: DCP-T420W/DCP-T425W/DCP-T426W

1. Do one of the following:
 - Windows 10
Click  > **Windows System** > **Control Panel**. In the **Hardware and Sound** group, click **View devices and printers**.
 - Windows 8.1
Move your mouse to the lower right corner of your desktop. When the menu bar appears, click **Settings**, and then click **Control Panel**. In the **Hardware and Sound** group, click **View devices and printers**.
 - Windows 7
Click  (**Start**) > **Devices and Printers**.
2. Right-click the machine icon, and then select **Scan profiles....** The **Scan Profiles** dialog box appears.
3. Select the scan profile you want to use.
4. Make sure the scanner selected in the **Scanner** list is a machine that supports Web Services for scanning, and then click the **Set as Default** button.
5. Click **Edit...**
The **Edit Default Profile** dialog box appears.
6. Select the **Source**, **Paper size**, **Colour format**, **File type**, **Resolution (DPI)**, **Brightness** and **Contrast** settings.
7. Click the **Save Profile** button.
These settings will be applied when you scan using the Web Services protocol.

If you are requested to select a scanning application, select Windows Fax and Scan from the list.



Related Information

- [Web Services for Scanning on Your Network \(Windows 7, Windows 8.1, and Windows 10\)](#)

Scan Using Brother iPrint&Scan (Windows/Mac)

1. Start Brother iPrint&Scan.

- Windows

Launch  (Brother iPrint&Scan).

- Mac

In the **Finder** menu bar, click **Go > Applications**, and then double-click the iPrint&Scan icon.

The Brother iPrint&Scan screen appears.

2. If your Brother machine is not selected, click the **Select your Machine** button, and then select your model name from the list. Click **OK**.
3. Click the **Scan** icon, and then follow the on-screen instructions to scan your documents.



Related Information

- [Scan](#)

Related Topics:

- [Change Scan Settings Using Brother iPrint&Scan](#)
-

Scan from Your Computer (Windows)

There are several ways you can use your computer to scan photos and documents on your machine. Use the software applications we provide or use your favourite scanning application.

- [Scan Using Nuance™ PaperPort™ 14SE or Other Windows Applications](#)
- [Scan Using Windows Fax and Scan](#)

Scan Using Nuance™ PaperPort™ 14SE or Other Windows Applications

You can use the Nuance™ PaperPort™ 14SE application for scanning.

- To download the Nuance™ PaperPort™ 14SE application, click  (**Brother Utilities**), select **Do More** in the left navigation bar, and then click **PaperPort**.
- Nuance™ PaperPort™ 14SE supports Windows 7, Windows 8.1, Windows 10 and Windows 11.
- For detailed instructions on using each application, click the application's **Help** menu, and then click **Getting Started Guide** in the **Help** ribbon.



The instructions for scanning in these steps are for PaperPort™ 14SE. For other Windows applications, the steps will be similar. PaperPort™ 14SE supports both TWAIN and WIA drivers; the TWAIN driver (recommended) is used in these steps.

Depending on the model of your machine, Nuance™ PaperPort™ 14SE may not be included. If it is not included, you can use other software applications that support scanning.

1. Load your document.

2. Start PaperPort™ 14SE.

Do one of the following:

- Windows 10

Click  > **Nuance PaperPort 14 > PaperPort**.

- Windows 8.1

Click  (**PaperPort**).

- Windows 7

Using your computer, click  (**Start**) > **All Programs > Nuance PaperPort 14 > PaperPort**.

3. Click the **Desktop** menu, and then click **Scan Settings** in the **Desktop** ribbon.

The **Scan or Get Photo** panel appears on the left side of the screen.

4. Click **Select**.

5. From the available Scanners list, select **TWAIN: TW-Brother XXX-XXXX** or **TWAIN: TW-Brother XXX-XXXX LAN** (where XXX-XXXX is the name of your model).

6. Select the **Display scanner dialog box** checkbox in the **Scan or Get Photo** panel.

7. Click **Scan**.

The Scanner Setup dialog box appears.

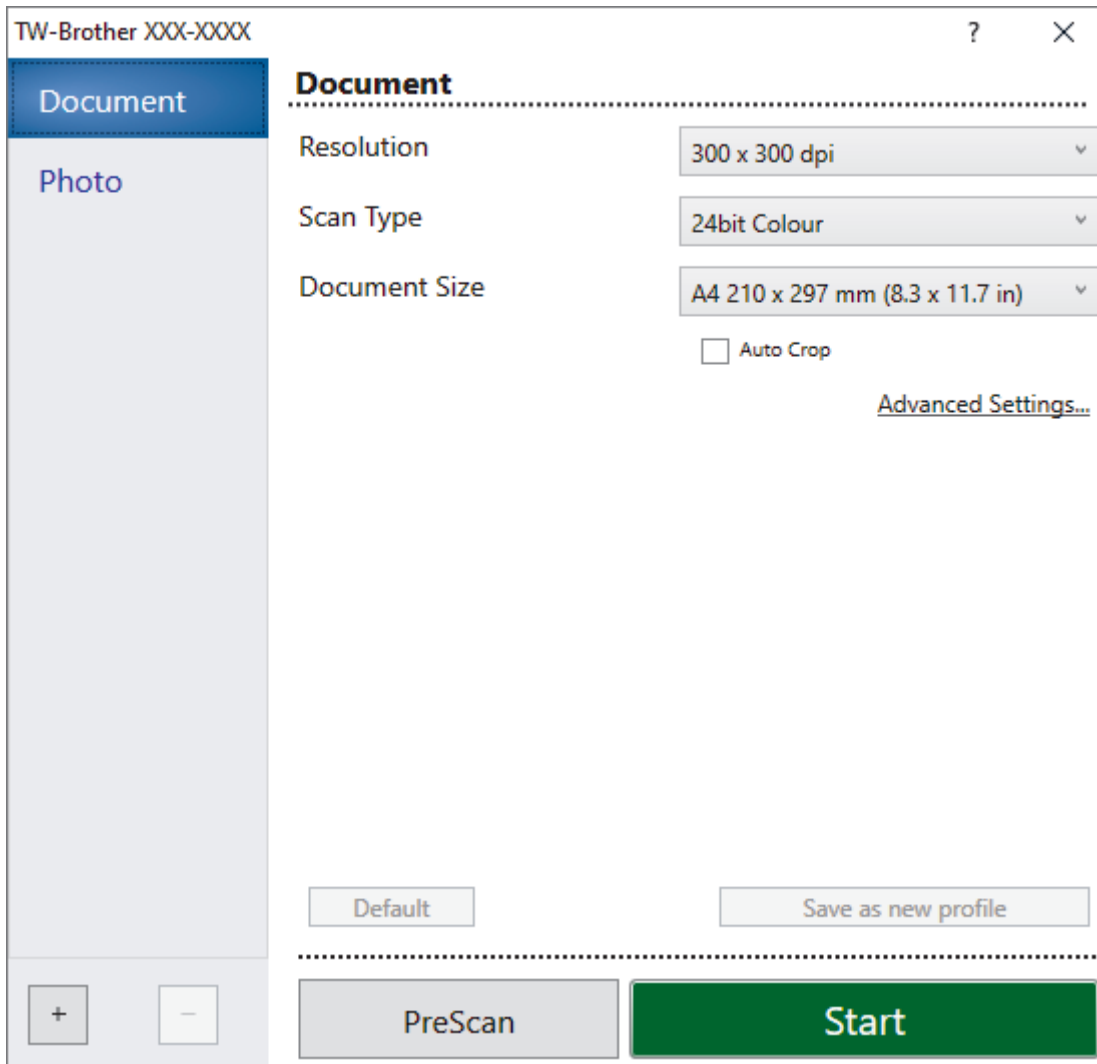



8. Adjust the settings in the Scanner Setup dialog box, if needed.
9. Click the **Document Size** drop-down list, and then select your document size.
10. Click **PreScan** to preview your image and crop unwanted portions before scanning.
11. Click **Start**.
The machine starts scanning.

✓ Related Information

- [Scan from Your Computer \(Windows\)](#)
- [TWAIN Driver Settings \(Windows\)](#)

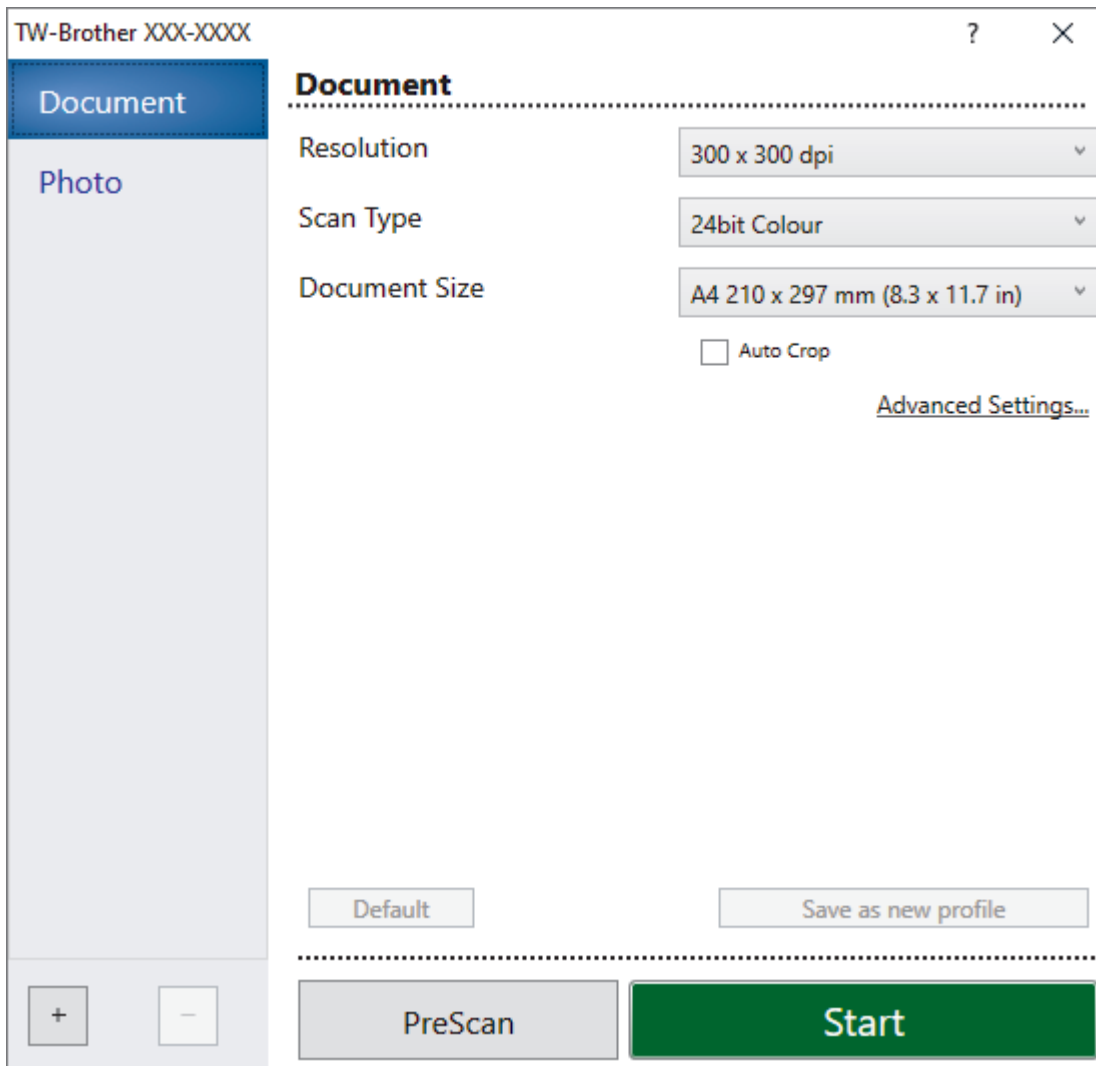
TWAIN Driver Settings (Windows)



 Note that the item names and assignable values will vary depending on the machine.

1. Scan

Select the **Photo** or **Document** option depending on the type of document you want to scan.

| Scan (Image Type) | | Resolution | Scan Type |
|-------------------|----------------------------------|---------------|---------------------|
| Photo | Use for scanning photo images. | 300 x 300 dpi | 24bit Colour |
| Document | Use for scanning text documents. | 300 x 300 dpi | 24bit Colour |

2. Resolution

Select a scanning resolution from the **Resolution** drop-down list. Higher resolutions take more memory and transfer time, but produce a finer scanned image.

3. Scan Type

Select from a range of scan colour depths.

- **Black & White**

Use for text or line art images.

- **Grey (Error Diffusion)**

Use for photographic images or graphics. (Error Diffusion is a method for creating simulated grey images without using true grey dots. Black dots are put in a specific pattern to give a grey appearance.)

- **True Grey**

Use for photographic images or graphics. This mode is more accurate because it uses up to 256 shades of grey.

- **24bit Colour**

Use to create an image with the most accurate colour reproduction. This mode uses up to 16.8 million colours to scan the image, but it requires the most memory and has the longest transfer time.

4. Document Size

Select the exact size of your document from a selection of preset scan sizes.

If you select **Custom**, the **Custom Document Size** dialog box appears and you can specify the document size.

5. Auto Crop

Scan multiple documents placed on the scanner glass. The machine will scan each document and create separate files or a single multi-page file.

6. Advanced Settings

Configure advanced settings by clicking the **Advanced Settings** link in the Scanner Setup dialog box.

- **Document Correction**

- **Rotate Image**

Rotate the scanned image.

- **Edge Fill**

Fill in the edges on four sides of the scanned image using the selected colour and range.

- **Image Quality**

- **Diffusion Adjustment -Grey**

Adjust the diffusion when selecting the **Grey (Error Diffusion)** option from the **Scan Type** drop-down list.

- **Colour Tone Adjustment**

Adjust the colour tone

- **Background Processing**

- **Remove Bleed-through / Pattern**

Prevent bleed-through.

- **Remove Background Colour**

Remove the base colour of documents to make the scanned data more legible.

- **Colour Drop**

Select a colour to remove from the scanned image.

- **Edge Emphasis**

Sharpen the characters in the original.

- **Reduce Noise**

Improve and enhance the quality of your scanned images with this selection. The **Reduce Noise** option is available when selecting the **24bit Colour** option and the **300 x 300 dpi**, **400 x 400 dpi**, or **600 x 600 dpi** scan resolution.

- **B&W Image Quality**

- **B&W Threshold Adjustment**

Adjust the threshold to generate a monochrome image.

- **Character Correction**

Correct the broken or incomplete characters of the original to make them easier to read.

- **B&W Inversion**

Invert black and white in the monochrome image.

- **Feed Control**

- **Continuous Scan**

- Select this option to scan multiple pages. After a page is scanned, select whether to continue scanning or finish.



Related Information

- [Scan Using Nuance™ PaperPort™ 14SE or Other Windows Applications](#)
-

Scan Using Windows Fax and Scan

Windows Fax and Scan application is another option that you can use for scanning.

Windows Fax and Scan uses the WIA scanner driver.

1. Load your document.
2. Launch Windows Fax and Scan.
3. Click **File > New > Scan**.
4. Select the scanner you want to use.
5. Click **OK**.

The **New Scan** dialog box appears.

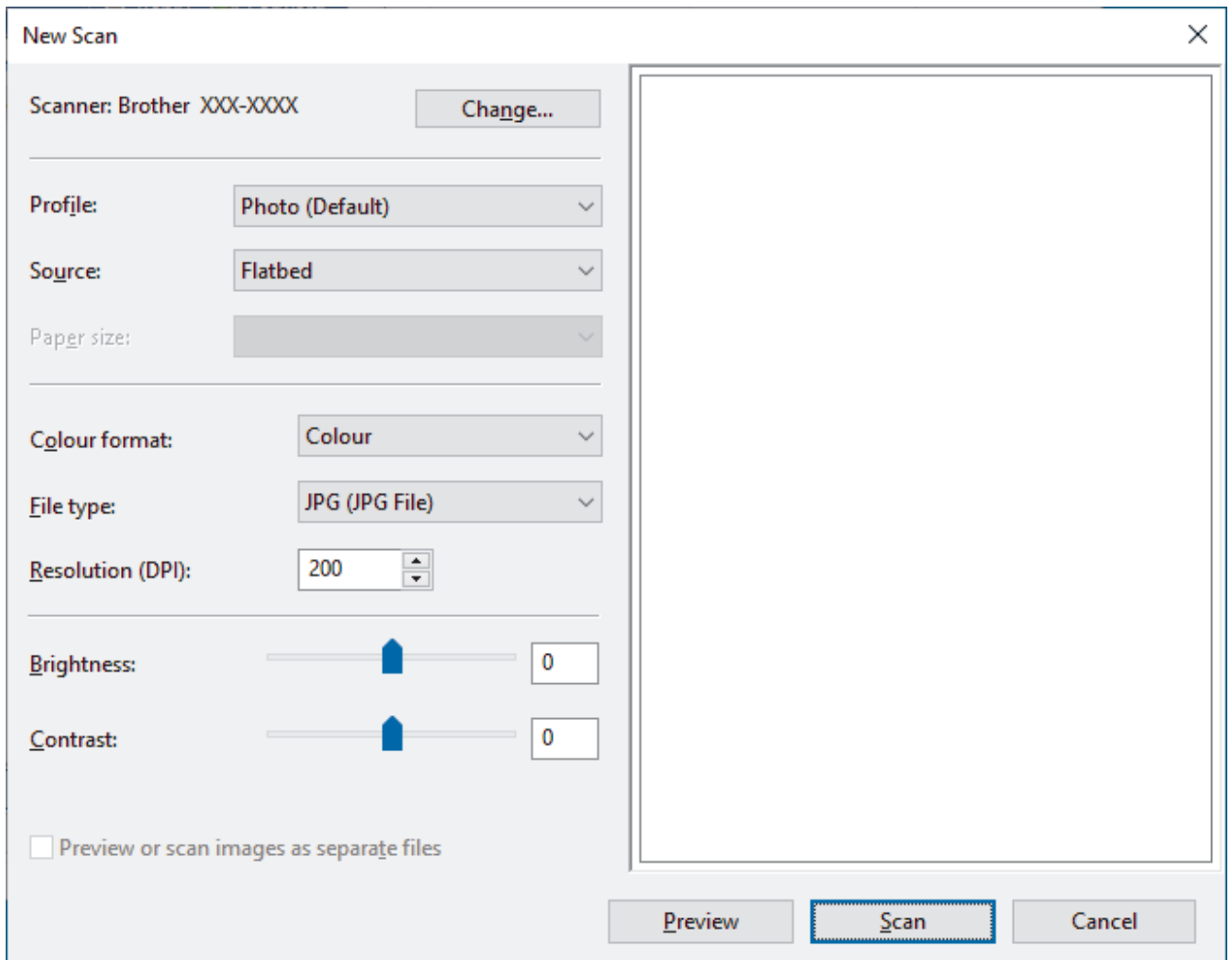

6. Adjust the settings in the dialog box, if needed.

The scanner resolution can be set to a maximum of 1200 dpi. If you want to scan at higher resolutions, use the **Scanner Utility** software from **Brother Utilities**.

7. Click **Scan**.

The machine starts scanning the document.

✓ Related Information

- [Scan from Your Computer \(Windows\)](#)
 - [WIA Driver Settings \(Windows\)](#)

WIA Driver Settings (Windows)

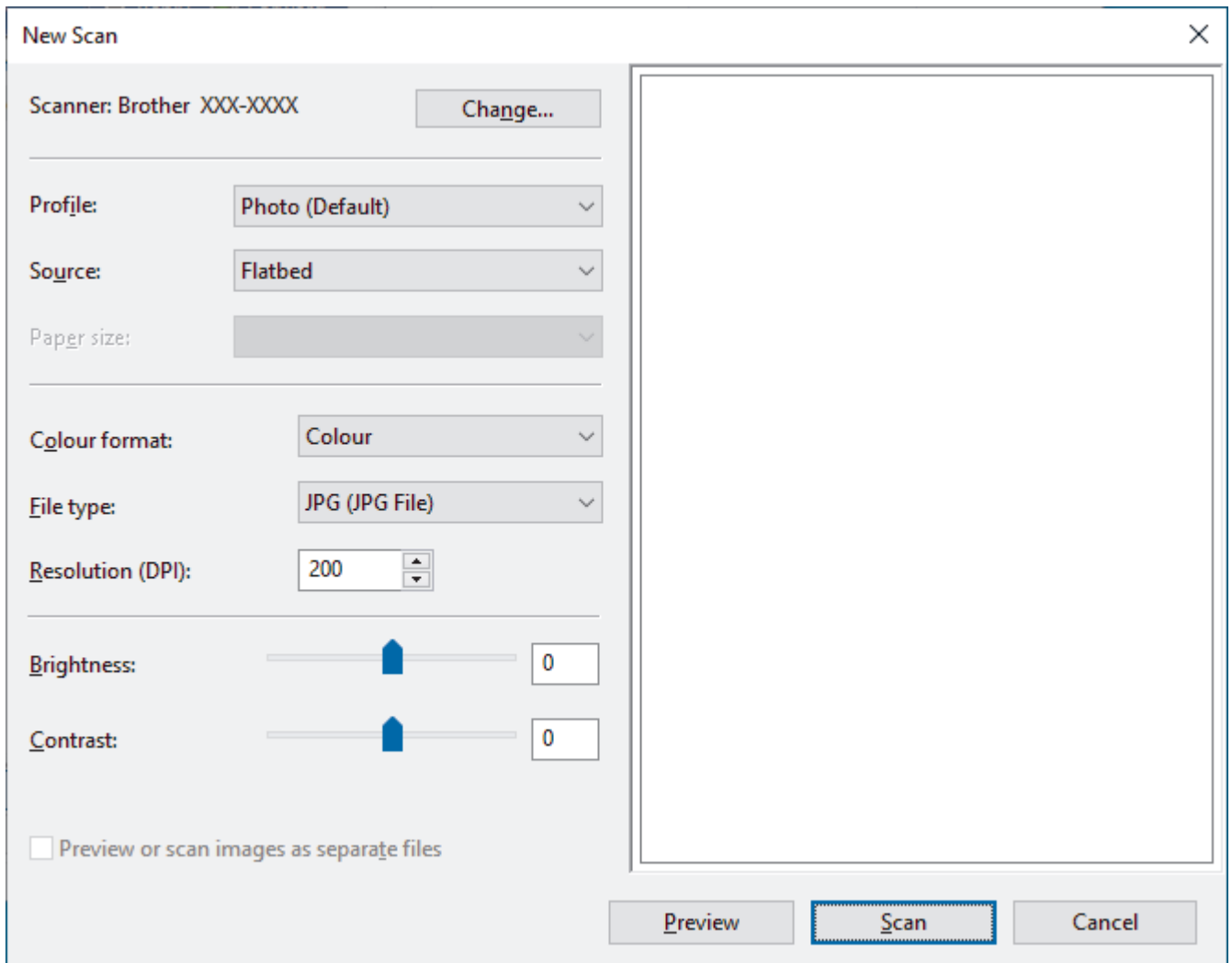

Profile

Select the scan profile you want to use from the **Profile** drop-down list.

Source

Select the **Flatbed** or **Feeder (Scan one side)** option from the drop-down list.

Paper size

The **Paper size** option is available if you select the **Feeder (Scan one side)** as the **Source** option.

Colour format

Select a scan colour format from the **Colour format** drop-down list.

File type

Select a file format from the **File type** drop-down list.

Resolution (DPI)

Set a scanning resolution in the **Resolution (DPI)** field. Higher resolutions take more memory and transfer time, but produce a finer scanned image.

Brightness

Set the **Brightness** level by dragging the slider to the right or left to lighten or darken the image. If the scanned image is too light, set a lower brightness level and scan the document again. If the image is too dark,

set a higher brightness level and scan the document again. You can also type a value in the field to set the brightness level.

Contrast

Increase or decrease the **Contrast** level by moving the slider to the right or left. An increase emphasises dark and light areas of the image, while a decrease reveals more details in grey areas. You can also type a value in the field to set the contrast level.



Related Information

- [Scan Using Windows Fax and Scan](#)

Scan from Your Computer (Mac)

- [Scan Using Apple Image Capture \(ICA Driver\)](#)

Scan Using Apple Image Capture (ICA Driver)

The Apple Image Capture application uses the ICA scanner driver.

To use the ICA scanner driver, go to your model's **Downloads** page at support.brother.com and download **Scanner Driver (ICA)**.

1. Launch the **Image Capture** application.
2. Select your Brother machine from the **DEVICES** list on the left side of the screen.

(DCP-T420W/DCP-T425W/DCP-T426W)

If you connected your Brother machine to your computer with a USB cable, you will see the machine in the **DEVICES** area. If connected via network, you will see it in the **SHARED** area.

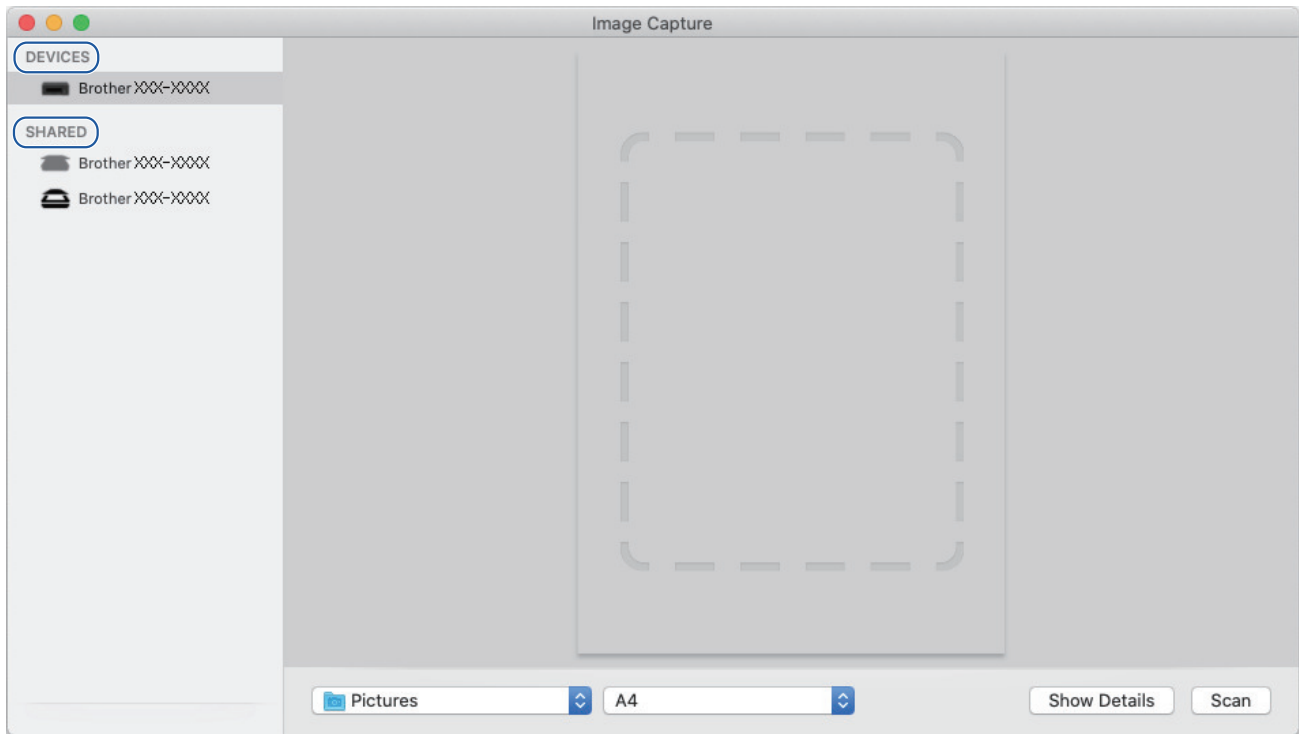

3. Load your document.
4. If you want to change the scan settings, click the **Show Details** button, and then configure the settings.
5. Select the destination folder or destination application from the **Scan To** pop-up menu.
6. Click **Scan**.

The machine starts scanning.



You can crop the image manually by dragging the mouse pointer over the portion you want to scan.



Related Information

- [Scan from Your Computer \(Mac\)](#)

Copy

- [Copy Overview](#)
- [Copy a Document](#)
- [Copy an ID Card](#)
- [Change the Copy Shortcut Button Settings Using Web Based Management](#)
- [Copy Using Brother iPrint&Scan](#)

Copy Overview

To make copies, do one of the following:

- Use the Brother iPrint&Scan application.
- Use your machine's **Mono Start/Colour Start** button.
- Use your machine's **Copy Shortcut** button. To change the button's settings, use Web Based Management.

| Available Copy Options | | Brother Machine | | Brother iPrint&Scan |
|--------------------------|----------------|-------------------------|---------------|---------------------|
| | | Mono Start/Colour Start | Copy Shortcut | |
| Number of Copies | | Yes | Yes | Yes |
| Color/Mono | | Yes | Yes | Yes |
| Quality | | Yes | Yes | Yes |
| Page Layout | 2in1 ID | No | Yes | Yes |
| | 2in1 | No | Yes | Yes |
| | 4in1 | No | No | Yes |
| | Poster | No | No | Yes |
| Enlarge/Reduce | Fit to Page | No | Yes | Yes |
| | A4→A5 | No | Yes | Yes |
| | Other Settings | No | No | Yes |
| Paper Size | | No | No | Yes |
| Paper Type | | No | No | Yes |
| Density | | No | No | Yes |
| Remove Background Colour | | No | No | Yes |



Related Information

- [Copy](#)

Related Topics:

- [Brother iPrint&Scan](#)
- [What is Web Based Management?](#)

Copy a Document

1. Make sure you have loaded the correct size paper in the paper tray.
2. Load your document.
3. Press **Mono Start** or **Colour Start**.



- If you want to copy with the best quality, press and hold **Mono Start** or **Colour Start** for two seconds.
- To make multiple copies, press **Mono Start** or **Colour Start** as many times as you want to make copies.
- To make multiple copies with the best quality:
 - a. Press and hold **Mono Start** or **Colour Start** for two seconds to make the first copy.
 - b. Press **Mono Start** or **Colour Start** once for each additional copy.
- To interrupt copying, press  (**Stop**).



Related Information

- [Copy](#)

Related Topics:

- [Load Documents on the Scanner Glass](#)
- [Copy Settings](#)
- [Change the Paper Size Settings](#)

Copy an ID Card

Use the 2 in 1 ID feature to copy both sides of an identification card onto one page, keeping the original card size.



- Make sure the paper size is set to A4 or Letter.
 - You may copy an identification card to the extent permitted under applicable laws. For more detailed information, see the *Product Safety Guide*.
1. Place your identification card **face down** near the lower-right corner of the scanner glass as shown.

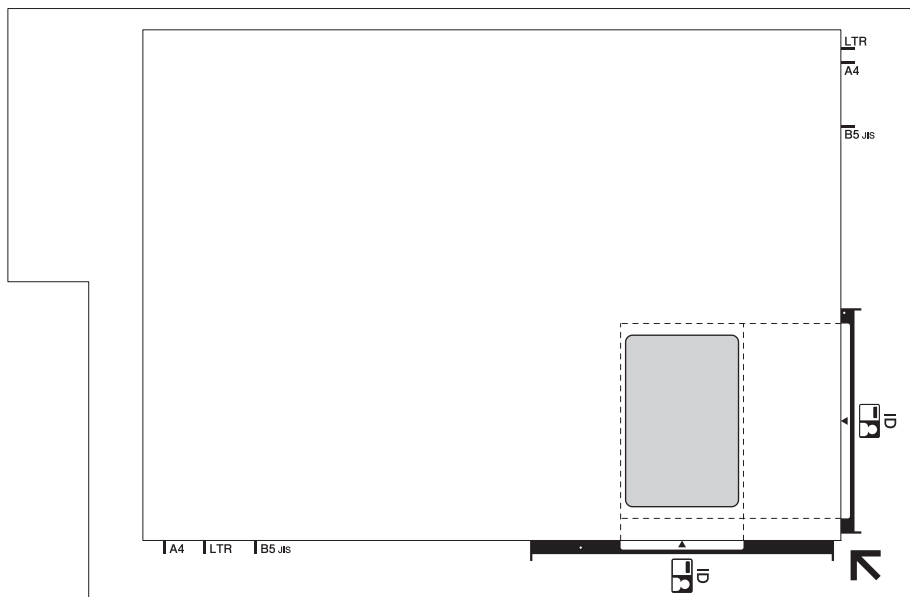

2. Press **Copy Shortcut**.
The machine starts scanning one side of the identification card.
3. After the machine has scanned the first side, the **Power LED** blinks slowly. Turn over the identification card and press **Copy Shortcut** to scan the other side.



You can change the **Copy Shortcut** button settings using Web Based Management.



✓ Related Information

- [Copy](#)

Related Topics:



- [Change the Copy Shortcut Button Settings Using Web Based Management](#)

Change the Copy Shortcut Button Settings Using Web Based Management

1. Start Brother iPrint&Scan.
 - Windows
Launch  (Brother iPrint&Scan).
 - Mac
In the **Finder** menu bar, click **Go > Applications**, and then double-click the iPrint&Scan icon.
The Brother iPrint&Scan screen appears.
2. If your Brother machine is not selected, click the **Select your Machine** button, and then select your model name from the list. Click **OK**.
3. Click  (**Machine Settings**) to configure the settings.
4. If required, type the password in the **Login** field, and then click **Login**.

 The default password to manage this machine's settings is located on the back of the machine and marked "Pwd".

5. Go to the navigation menu, and then click **Copy > Copy Shortcut**.

 Start from , if the navigation menu is not shown on the left side of the screen.

6. Select the copy preset you want to use as **Copy Shortcut** from the **Copy Preset** drop-down list.

| Option | Description |
|-------------------------------------|---|
| 2in1 ID (2in1 ID Horizontal) | Copy Layout: 2in1 ID (2in1 ID Horizontal) |
| 2in1 ID (2in1 ID Vertical) | Copy Layout: 2in1 ID (2in1 ID Vertical) |
| 2in1 | Copy Layout: 2in1 |
| Continuous Copy | Continuous Copy (Max 99 pages) |
| Best Quality, A4→A5 | Quality: Best, Reduce: A4→A5 |
| Fit to Page | Enlarge/Reduce: Fit to Page |

7. Select the **Colour Setting** option.
8. Click **Submit**.

 When selecting the **2in1 ID (2in1 ID Horizontal)**, **2in1 ID (2in1 ID Vertical)**, or **2in1** option:
After the machine has scanned the first side, the **Power LED** blinks slowly. Turn over the identification card and press **Copy Shortcut** to scan the other side.

Related Information

- [Copy](#)

Related Topics:

- [Copy an ID Card](#)
- [Access Web Based Management](#)

Copy Using Brother iPrint&Scan



- [Make Page Layout Copies \(N in 1 or Poster\)](#)
- [Copy Settings](#)





Make Page Layout Copies (N in 1 or Poster)

The N in 1 copy feature saves paper by copying two or four pages of your document onto one page of the copy. The poster feature divides your document into sections, then enlarges the sections so you can assemble them into a poster.



- Make sure the paper size is set to A4 or Letter.
 - You can make only one Poster copy at a time.
1. Load your document.
 2. Start Brother iPrint&Scan.
 - Windows
Launch  (Brother iPrint&Scan).
 - Mac
In the **Finder** menu bar, click **Go > Applications**, and then double-click the iPrint&Scan icon.
The Brother iPrint&Scan screen appears.
 3. Click **Copy**.
 4. Select the **Page Layout** option you want.

| Option | Description |
|-----------------|---|
| Off(1in1) | - |
| 2in1(Portrait) |  |
| 2in1(Landscape) |  |

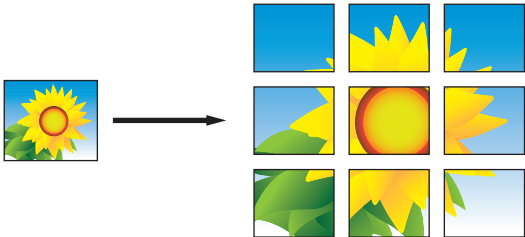
| Option | Description |
|--------------------|--|
| 2in1 ID Vertical |  |
| 2in1 ID Horizontal |  |
| 4in1(Portrait) |  |
| 4in1(Landscape) |  |
| Poster(3x3) |  |

5. Click **Copy**.
6. For making a N in 1 copy, do the following:
 - a. Place the next page on the scanner glass, and then click **Continue** to scan the page.
 - b. After scanning all the pages, click **Finish**.



You can use Brother iPrint&Scan for mobile devices as well as Brother iPrint&Scan for Windows/Mac.

✓ Related Information

- [Copy Using Brother iPrint&Scan](#)

Related Topics:

- [Copy Settings](#)

Copy Settings

You can configure the copy settings in the **Copy** screen.

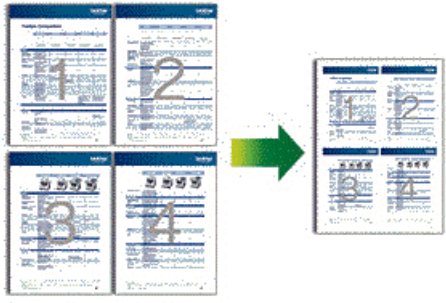
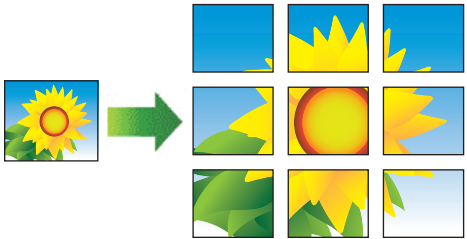
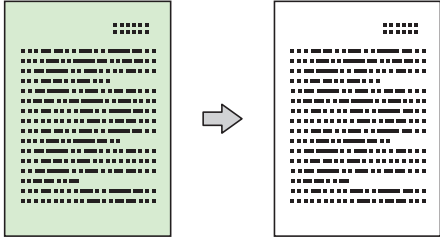
| Option | Description | |
|---|--|---|
| Copies | Enter the number of copies (1-99). | |
| Colour / Mono | Colour | Makes copies in full colour. |
| | Mono | Makes copies in monochrome. |
| Enlarge/Reduce | 100% | - |
| | Scaling | Select an option to enlarge or reduce the size of the pages in your document. |
| | Fit to Page | Adjusts the copy size to fit on the paper size you have set. |
| | Custom(25-400%) | Enter an enlargement or reduction ratio. |
| Density | Increase the density to make the text darker. Decrease the density to make the text lighter. | |
| Paper Size | Select a paper size. If copying on paper other than A4 size, you must change the Paper Size setting. | |
| Page Layout | Make N in 1, 2 in 1 ID, or Poster copies. | |
| | <p>4 in 1</p>  | <p>Poster</p>  |
| Quality | Select the Copy resolution for your type of document. | |
| Paper Type | Select a paper type. If copying on special paper, set the machine for the type of paper you are using to get the best print quality. | |
| Remove Color Background or Remove Black Background | Removes the document's background colour in copies. The white becomes more apparent. This saves some ink and may make certain copies easier to read. | |
| |  | |



Related Information

- [Copy Using Brother iPrint&Scan](#)

Related Topics:

- [Copy a Document](#)

-
- Make Page Layout Copies (N in 1 or Poster)
-

Network

Related Models: DCP-T420W/DCP-T425W/DCP-T426W

- [Supported Basic Network Features](#)
- [Configure Network Settings](#)
- [Wireless Network Settings](#)
- [Network Features](#)
- [Brother Management Tools](#)

Supported Basic Network Features

Related Models: DCP-T420W/DCP-T425W/DCP-T426W

The print server supports various features depending on the operating system. Use this table to see which network features and connections are supported by each operating system.

| Operating Systems | Windows | Windows Server | macOS |
|-----------------------------------|---------|----------------|-------|
| Printing | Yes | Yes | Yes |
| Scanning | Yes | No | Yes |
| Web Based Management ¹ | Yes | Yes | Yes |
| Status Monitor | Yes | No | No |
| Driver Deployment Wizard | Yes | Yes | No |

¹ The default password to manage this machine's settings is located on the back of the machine and marked "Pwd". We recommend immediately changing the default password to protect your machine from unauthorised access.



When connecting your machine to an outside network such as the Internet, make sure your network environment is protected by a separate firewall or other means in order to prevent information leaks due to inadequate settings or unauthorised access by malicious third parties.



Related Information

- [Network](#)

Related Topics:

- [Set or Change a Login Password for Web Based Management](#)

Configure Network Settings

Related Models: DCP-T420W/DCP-T425W/DCP-T426W

- [Configure Network Settings Using the Control Panel](#)
- [Change Machine Settings Using Web Based Management](#)

Configure Network Settings Using the Control Panel

Related Models: DCP-T420W/DCP-T425W/DCP-T426W

To configure the machine for your network, use the control panel buttons.

Network Settings

| Function | Button 1 | Button 2 | Instructions |
|--|------------------------|---|-----------------------------------|
| Enable the One Push Method of Wi-Fi Protected Setup™ (WPS). | WiFi Button/LED | - | Press the button three times. |
| Enable the PIN Method of Wi-Fi Protected Setup™ (WPS). | WiFi Button/LED | - | Press the button five times. |
| Enter Wi-Fi Mode. | WiFi Button/LED |  | Press the buttons simultaneously. |
| Set Wireless Direct to On. Print the Wireless Direct Information Sheet. | WiFi Button/LED | Copy Shortcut | Press the buttons simultaneously. |
| Print the Network Configuration Report Sheet. | WiFi Button/LED | Mono Start | Press the buttons simultaneously. |
| Restart Wi-Fi and Wireless Direct. Use this function to solve wireless network problems. | WiFi Button/LED | Colour Start | Press the buttons simultaneously. |

Wi-Fi Mode

| Function | Button | Instructions |
|------------------------------------|------------------------|--|
| Print the WLAN Report. | WiFi Button/LED | Press the button once. |
| Enable or disable Wireless Direct. | Copy Shortcut | Press the button once. |
| Enable or disable Wi-Fi. | Mono Start | Press the button once. |
| Reset the Network settings. | Colour Start | Press and hold the button for two seconds. |

Related Information

- [Configure Network Settings](#)

Wireless Network Settings

Related Models: DCP-T420W/DCP-T425W/DCP-T426W

- [Use the Wireless Network](#)
- [Use Wireless Direct](#)
- [Enable/Disable Wireless LAN](#)
- [Print the WLAN Report](#)

Use the Wireless Network

Related Models: DCP-T420W/DCP-T425W/DCP-T426W

- [Before Configuring Your Machine for a Wireless Network](#)
- [Configure Your Machine for a Wireless Network Using the Setup Wizard from Your Computer](#)
- [Configure Your Machine for a Wireless Network Using the Setup Wizard from Your Mobile Device](#)
- [Configure Your Machine for a Wireless Network Using the One Push Method of Wi-Fi Protected Setup™ \(WPS\)](#)
- [Configure Your Machine for a Wireless Network Using the PIN Method of Wi-Fi Protected Setup™ \(WPS\)](#)

Before Configuring Your Machine for a Wireless Network

Related Models: DCP-T420W/DCP-T425W/DCP-T426W

Before attempting to configure a wireless network, confirm the following:

- To achieve optimum results with normal everyday document printing, place your machine as close to the wireless LAN access point/router as possible with minimal obstructions. Large objects and walls between the two devices and interference from other electronic devices can affect the data transfer speed of your documents.

Due to these factors, wireless may not be the best method of connection for all types of documents and applications. If you are printing large files, such as multi-page documents with mixed text and large graphics, you may want to consider selecting USB for the fastest print speed.

- If there is a signal in the vicinity, wireless LAN allows you to freely make a LAN connection. However, if security settings are not correctly configured, the signal may be intercepted by malicious third-parties, possibly resulting in:
 - Theft of personal or confidential information
 - Improper transmission of information to parties impersonating the specified individuals
 - Dissemination of transcribed communication contents that were intercepted



Make sure you know your wireless router/access point's Network Name (SSID) and Network Key (Password). If you cannot find this information, consult the manufacturer of your wireless router/access point, your system administrator, or Internet provider. Brother cannot provide this information.



Related Information

- [Use the Wireless Network](#)

Configure Your Machine for a Wireless Network Using the Setup Wizard from Your Computer

Related Models: DCP-T420W/DCP-T425W/DCP-T426W

1. Do one of the following:
 - Windows
Download the installer from your model's **Downloads** page at support.brother.com.
 - Mac
 - a. Download the installer from your model's **Downloads** page at support.brother.com.
 - b. Start the installer, and then double-click the **Start Here Mac** icon.
2. Follow the on-screen instructions.
3. Select **Wireless Network Connection (Wi-Fi)**, and then click **Next**.
4. Follow the on-screen instructions.

You have completed the wireless network setup.



Related Information

- [Use the Wireless Network](#)

Configure Your Machine for a Wireless Network Using the Setup Wizard from Your Mobile Device

Related Models: DCP-T420W/DCP-T425W/DCP-T426W

1. Do one of the following:
 - Android™ Devices
Download and install Brother iPrint&Scan from Google Play™.
 - All iOS supported devices including iPhone, iPad and iPod touch
Download and install Brother iPrint&Scan from the App Store.
2. Start Brother iPrint&Scan, and then follow the on-screen instructions to connect your mobile device to your Brother machine.



Related Information

- [Use the Wireless Network](#)

Configure Your Machine for a Wireless Network Using the One Push Method of Wi-Fi Protected Setup™ (WPS)

Related Models: DCP-T420W/DCP-T425W/DCP-T426W

If your wireless access point/router supports WPS (Push Button Configuration), you can use **WiFi Button/LED** on your machine's control panel to configure your wireless network settings.

1. Press **WiFi Button/LED** three times.
The **WiFi Button/LED** starts blinking.
2. Press the WPS button on your wireless access point/router.

If your wireless device is connected successfully, the **Power LED** and **WiFi Button/LED** are lit.

You have completed the wireless network setup. To install the drivers and software necessary to use your machine, go to your model's **Downloads** page at support.brother.com.

(Windows) Or, use the Brother installation disc to set up your machine (not available in all countries).

Related Information

- [Use the Wireless Network](#)

Configure Your Machine for a Wireless Network Using the PIN Method of Wi-Fi Protected Setup™ (WPS)

Related Models: DCP-T420W/DCP-T425W/DCP-T426W

If your wireless LAN access point/router supports WPS, you can use the Personal Identification Number (PIN) Method to configure your wireless network settings.

The PIN Method is one of the connection methods developed by the Wi-Fi Alliance®. By submitting a PIN created by an Enrollee (your machine) to the Registrar (a device that manages the wireless LAN), you can set up the wireless network and security settings. For more information on how to access WPS mode, see the instructions provided with your wireless access point/router.

Type A

Connection when the wireless LAN access point/router (1) doubles as the Registrar.

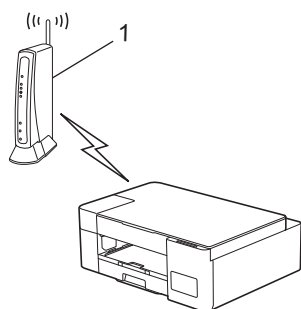

Type B

Connection when another device (2), such as a computer, is used as the Registrar.

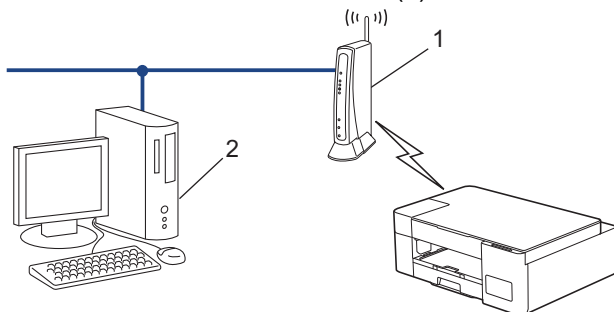

1. Press **WiFi Button/LED** five times.
The **WiFi Button/LED** starts blinking, and the machine prints an eight-digit PIN.
2. Using a computer connected to the network, in your browser's address bar, type the IP address of the device you are using as the Registrar. (For example: <http://192.168.1.2>)
3. Go to the WPS settings page and type the PIN, and then follow the on-screen instructions.



- The Registrar is usually the wireless LAN access point/router.
- The settings page may differ depending on the brand of wireless LAN access point/router. For more information, see the instructions supplied with your wireless LAN access point/router.

If you are using a Windows 7, Windows 8.1, or Windows 10 computer as a Registrar, complete the following steps:

4. Do one of the following:
 - Windows 10
Click  > **Windows System** > **Control Panel**. In the **Hardware and Sound** group, click **Add a device**.
 - Windows 8.1

Move your mouse to the lower right corner of your desktop. When the menu bar appears, click **Settings > Control Panel > Hardware and Sound > Devices and Printers > Add a device**.

- Windows 7

Click  **(Start) > Devices and Printers > Add a device**.



-
- To use a Windows 7, Windows 8.1, or Windows 10 computer as a Registrar, you must register it to your network in advance. For more information, see the instructions supplied with your wireless LAN access point/router.
 - If you use Windows 7, Windows 8.1, or Windows 10 as a Registrar, you can install the printer driver after the wireless configuration by following the on-screen instructions. To install the driver and software necessary to use your machine, go to your model's **Downloads** page at support.brother.com.
Use the Brother installation disc to set up your machine (not available in all countries).
-

5. Select your machine and click **Next**.
6. Type the PIN, and then click **Next**.
7. (Windows 7) Select your network, and then click **Next**.
8. Click **Close**.



Related Information

- [Use the Wireless Network](#)
-

Use Wireless Direct

Related Models: DCP-T420W/DCP-T425W/DCP-T426W

- [Wireless Direct Overview](#)
- [Configure Your Wireless Direct Network](#)

Wireless Direct Overview

Related Models: DCP-T420W/DCP-T425W/DCP-T426W

Wireless Direct allows you to configure a secured wireless network between your Brother machine and your wireless device (computer, smartphone, tablet, or similar), without using a wireless router/access point. You can configure a wireless network by manually setting a Network Name (SSID) and Network Key (Password).

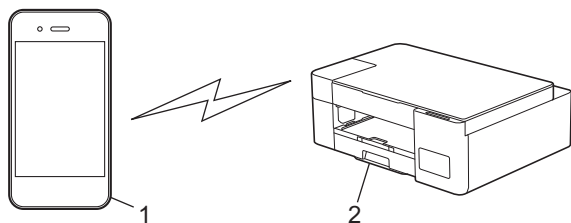

1. Wireless device
2. Your Brother machine

✓ Related Information

- [Use Wireless Direct](#)

Configure Your Wireless Direct Network

Related Models: DCP-T420W/DCP-T425W/DCP-T426W

1. Press **WiFi Button/LED** and **Copy Shortcut** simultaneously.
Wireless Direct is enabled and the machine starts printing the Wireless Direct Information Sheet.
2. Activate the Wi-Fi function on your wireless device and search for your Brother machine.
3. Select your Brother machine's SSID (Network Name) on your wireless device (DIRECT-xxDCP-xxxx_BRxxxx).
4. Enter the Network Key (Password) when prompted.



- The SSID and Network Key are printed on the Wireless Direct Information Sheet.
- To disable Wireless Direct:
 - a. Press **WiFi Button/LED** and  (**Stop**) simultaneously.

The **Power LED**, **Warning LED**, and **Ink LED** light up for one second, and then the **WiFi Button/LED** starts blinking.

- b. Press **Copy Shortcut**.



Related Information

- [Use Wireless Direct](#)

Enable/Disable Wireless LAN

Related Models: DCP-T420W/DCP-T425W/DCP-T426W

1. Press **WiFi Button/LED** and  (**Stop**) simultaneously.

The **Power LED**, **Warning LED**, and **Ink LED** light up for one second, and then the **WiFi Button/LED** starts blinking.

2. Press **Mono Start** to enable Wi-Fi.
 - When Wi-Fi is enabled, the **Power LED** blinks once, and then the **Power LED** and **WiFi Button/LED** are lit.
 - When Wi-Fi is disabled, the **Power LED** blinks twice, and then the **Power LED** is lit.

Related Information

- [Wireless Network Settings](#)

Print the WLAN Report

Related Models: DCP-T420W/DCP-T425W/DCP-T426W

The WLAN Report shows your machine's wireless status. If the wireless connection fails, check the error code on the printed report.

1. Press **WiFi Button/LED** and  (**Stop**) simultaneously.

The **Power LED**, **Warning LED**, and **Ink LED** light up for one second, and then the **WiFi Button/LED** starts blinking.

2. Press **WiFi Button/LED**.

Your Brother machine starts printing the WLAN Report.



Related Information

- [Wireless Network Settings](#)
 - [Wireless LAN Report Error Codes](#)

Related Topics:

- [If You Are Having Difficulty with Your Machine's Network](#)

Wireless LAN Report Error Codes

Related Models: DCP-T420W/DCP-T425W/DCP-T426W

If the Wireless LAN Report shows that the connection failed, check the error code on the printed report and see the corresponding instructions in the table:

| Error Code | Problem and Recommended Solutions |
|------------|--|
| TS-01 | The wireless feature is not ON. Check the following point and try to set up your wireless connection again: Turn the wireless feature ON. |
| TS-02 | The wireless access point/router cannot be detected. Check the following points and try to set up your wireless connection again: <ol style="list-style-type: none"> 1. Turn your wireless access point/router off, wait for 10 seconds, and then turn it on again. 2. Temporarily place your machine closer to the wireless router/access point when you are configuring the wireless settings. 3. If your wireless router/access point is using MAC address filtering, confirm the MAC address of the Brother machine is allowed in the filter. You can find the MAC address by printing the Network Configuration Report. 4. If you manually entered the Network Name (SSID) and security information (authentication method / encryption method / Network Key (Password)), the information may be incorrect. Check the Network Name and security information and re-enter the correct information. 5. Your Brother machine may not support a 5 GHz SSID/ESSID. Make sure your wireless access point/router is set to 2.4 GHz or 2.4 GHz / 5 GHz mixed mode. For more information, see the documentation provided with your wireless router/access point. |
| TS-04 | Your Brother machine does not support the authentication and encryption methods used by the selected wireless router/access point. Change the authentication and encryption methods of the wireless router/access point. Your Brother machine supports the following authentication and encryption methods: <ul style="list-style-type: none"> • WPA-Personal TKIP / AES • WPA2-Personal TKIP / AES • Open WEP or None (without encryption) • Shared key WEP If your issue is not solved, the Network Name (SSID) or security settings you entered may be incorrect. Check all wireless network settings are correct for your network. |
| TS-05 | The Network Name (SSID) and Network Key (Password) are incorrect. Check the following points and try to set up your wireless connection again: <ol style="list-style-type: none"> 1. Confirm the Network Name (SSID) and Network Key (Password). Brother cannot provide this information. If your Network Key contains upper-case and lower-case letters, make sure you type them correctly. 2. If you cannot find the Network Name (SSID) and security information, see the documentation provided with your wireless router/access point, or contact the router manufacturer, your system administrator, or Internet service provider. 3. If your wireless router/access point uses WEP encryption with multiple WEP keys, write down and use only the first WEP key. |

| Error Code | Problem and Recommended Solutions |
|------------|---|
| TS-06 | <p>The wireless security information (Authentication method / Encryption method / Network Key) is incorrect. Check the following points and try to set up your wireless connection again:</p> <ol style="list-style-type: none"> 1. Confirm the Network Key. If your Network Key contains upper-case and lower-case letters, make sure you type them correctly. Brother cannot provide this information. 2. Confirm whether the authentication method entered and the authentication method or encryption method supported by the wireless router/access point are the same. 3. If the network key, authentication method, and encryption method have been confirmed, restart your wireless router/access point and Brother machine. 4. If the machine is still unable to connect and your router supports WPS, try connecting with WPS. To set up your wireless connection using WPS, you must enable WPS on the Brother machine and wireless router/access point. |
| TS-07 | <p>The machine cannot detect a wireless router/access point that has WPS enabled. Check the following points and try again:</p> <ol style="list-style-type: none"> 1. To check if your wireless router/access point supports WPS, look for the WPS symbol displayed on the router/access point. For more information, see the documentation provided with your wireless router/access point. 2. To set up your wireless connection using WPS, you must configure both your Brother machine and the wireless router/access point. 3. If you do not know how to set up your wireless router/access point using WPS, see the documentation provided with your wireless router/access point, or contact the router manufacturer, your system administrator, or Internet service provider. |
| TS-08 | <p>Two or more wireless access points that have WPS enabled are detected. Check the following points and try again:</p> <ol style="list-style-type: none"> 1. Make sure that only one wireless router/access point within range has WPS enabled, and then try to connect again. 2. Try to connect again after a few minutes to avoid interference from other access points/routers. |



How to confirm wireless security information (SSID/authentication method/encryption method/Network Key) of your WLAN access point/router:

1. The default security settings may be provided on a label attached to the WLAN access point/router. Or the manufacturer's name or model number of the WLAN access point/router may be used as the default security settings.
2. See the documentation provided with your WLAN access point/router for information on how to find the security settings.
 - If the WLAN access point/router is set to not broadcast the SSID, the SSID will not automatically be detected. You will have to manually enter the SSID name.
 - The Network key may also be described as the Password, Security Key, or Encryption Key.

If you do not know the SSID and wireless security settings of your WLAN access point/router or how to change the configuration, see the documentation provided with your WLAN access point/router, ask the manufacturer of your access point/router or ask your Internet provider or network administrator.



Related Information

- [Print the WLAN Report](#)

Related Topics:

- [If You Are Having Difficulty with Your Machine's Network](#)
- [Print the Network Configuration Report](#)

Network Features

Related Models: DCP-T420W/DCP-T425W/DCP-T426W

- [Print the Network Configuration Report](#)
- [Reset the Network Settings to Factory Settings](#)

Print the Network Configuration Report

Related Models: DCP-T420W/DCP-T425W/DCP-T426W

The Network Configuration Report lists the network configuration, including the network print server settings.



- **Node Name:** The Node Name appears on the current Network Configuration Report. The default Node Name is "BRWxxxxxxxxxxxx" (where "xxxxxxxxxxxx" is your machine's MAC Address / Ethernet Address.)
- If the IP Address on the Network Configuration Report shows 0.0.0.0, wait for one minute and try printing it again.
- You can find your machine's settings, such as the IP address, subnet mask, node name, and MAC Address on the report, for example:
 - IP address: 192.168.0.5
 - Subnet mask: 255.255.255.0
 - Node name: BRN000ca0000499
 - MAC Address: 00-0c-a0-00-04-99

1. Press **WiFi Button/LED** and **Mono Start** simultaneously.
The machine starts printing the Network Configuration Report.



Related Information

- [Network Features](#)

Related Topics:

- [Access Web Based Management](#)
- [Check the Brother Machine's Network Settings](#)
- [Use the Network Connection Repair Tool \(Windows\)](#)
- [If You Are Having Difficulty with Your Machine's Network](#)

Reset the Network Settings to Factory Settings

Related Models: DCP-T420W/DCP-T425W/DCP-T426W

You can use the buttons on the control panel to reset your machine to its factory settings. This resets all information, such as the password and IP address.



You can also reset the print server to its factory settings using Web Based Management.

1. Press **WiFi Button/LED** and  (**Stop**) simultaneously.

The **Power LED**, **Warning LED**, and **Ink LED** light up for one second, and then the **WiFi Button/LED** starts blinking.

2. Press and hold **Colour Start** for two seconds.
3. Wait until the machine restarts and the Power LED indicator lights up before disconnecting the machine from the power source.



Related Information

- [Network Features](#)

Brother Management Tools

Related Models: DCP-T420W/DCP-T425W/DCP-T426W

Use one of Brother's management tools to configure your Brother machine's network settings. Go to your model's **Downloads** page at support.brother.com to download the tools.



Related Information

- [Network](#)
-

Security

Related Models: DCP-T420W/DCP-T425W/DCP-T426W

- [Before Using Network Security Features](#)
- [Configure Certificates for Device Security](#)
- [Use SSL/TLS](#)

Before Using Network Security Features

Related Models: DCP-T420W/DCP-T425W/DCP-T426W

Your machine employs some of the latest network security and encryption protocols available today. These network features can be integrated into your overall network security plan to help protect your data and prevent unauthorised access to the machine.



We recommend disabling the FTP and TFTP protocols. Accessing the machine using these protocols is not secure.



Related Information

- [Security](#)

Configure Certificates for Device Security

Related Models: DCP-T420W/DCP-T425W/DCP-T426W

You must configure a certificate to manage your networked machine securely using SSL/TLS. You must use Web Based Management to configure a certificate.

- [Supported Security Certificate Features](#)
- [Step by Step Guide for Creating and Installing a Certificate](#)
- [Create a Self-signed Certificate](#)
- [Create CSR and Install a Certificate from a Certificate Authority \(CA\)](#)
- [Import and Export the Certificate and Private Key](#)
- [Manage Multiple Certificates](#)

Supported Security Certificate Features

Related Models: DCP-T420W/DCP-T425W/DCP-T426W

Your machine supports the use of multiple security certificates, which allows secure authentication and communication with the machine. The following security certificate features can be used with the machine:

SSL/TLS communication

The Brother machine supports the following:

- Pre-installed certificate

Your machine has a pre-installed self-signed certificate. This certificate enables you to use SSL/TLS communication without creating or installing a different certificate.



The pre-installed self-signed certificate protects your communication up to a certain level. We recommend using a certificate that is issued by a trusted organisation for better security.

- Self-signed certificate

This print server issues its own certificate. Using this certificate, you can easily use the SSL/TLS communication without creating or installing a different certificate from a CA.

- Certificate from a Certificate Authority (CA)

There are two methods for installing a certificate from a CA. If you already have a certificate from a CA or if you want to use a certificate from an external trusted CA:

- When using a Certificate Signing Request (CSR) from this print server.
- When importing a certificate and a private key.



- If you are going to use SSL/TLS communication, we recommend contacting your system administrator first.
- When you reset the print server back to its default factory settings, the certificate and the private key that are installed will be deleted. If you want to keep the same certificate and the private key after resetting the print server, export them before resetting, and then reinstall them.



Related Information

- [Configure Certificates for Device Security](#)

Step by Step Guide for Creating and Installing a Certificate

Related Models: DCP-T420W/DCP-T425W/DCP-T426W

There are two options when choosing a security certificate: use a self-signed certificate or use a certificate from a Certificate Authority (CA).

Option 1

Self-Signed Certificate

1. Create a self-signed certificate using Web Based Management.
2. Install the self-signed certificate on your computer.

Option 2

Certificate from a CA

1. Create a Certificate Signing Request (CSR) using Web Based Management.
2. Install the certificate issued by the CA on your Brother machine using Web Based Management.
3. Install the certificate on your computer.



Related Information

- [Configure Certificates for Device Security](#)

Create a Self-signed Certificate

Related Models: DCP-T420W/DCP-T425W/DCP-T426W

1. Start your web browser.
2. Type "https://machine's IP address" in your browser's address bar (where "machine's IP address" is the machine's IP address).

For example:

https://192.168.1.2



If you are using a Domain Name System or enable a NetBIOS name, you can type another name, such as "SharedPrinter" instead of the IP address.

For example:

https://SharedPrinter

If you enable a NetBIOS name, you can also use the node name.

For example:

https://brnxxxxxxxxxxxx

The NetBIOS name can be found in the Network Configuration Report.

3. If required, type the password in the **Login** field, and then click **Login**.



The default password to manage this machine's settings is located on the back of the machine and marked "Pwd".

4. Go to the navigation menu, and then click **Network > Security > Certificate**.



Start from , if the navigation menu is not shown on the left side of the screen.

5. Click **Create Self-Signed Certificate**.
6. Enter a **Common Name** and a **Valid Date**.
 - The length of the **Common Name** is less than 64 bytes. Enter an identifier, such as an IP address, node name, or domain name to use when accessing this machine through SSL/TLS communication. The node name is displayed by default.
 - A warning will appear if you use the IPPS or HTTPS protocol and enter a different name in the URL than the **Common Name** that was used for the self-signed certificate.
7. Select your setting from the **Public Key Algorithm** drop-down list. The default setting is **RSA(2048bit)**.
8. Select your setting from the **Digest Algorithm** drop-down list. The default setting is **SHA256**.
9. Click **Submit**.



Related Information

- [Configure Certificates for Device Security](#)

Related Topics:

- [Access Web Based Management](#)

Create CSR and Install a Certificate from a Certificate Authority (CA)

Related Models: DCP-T420W/DCP-T425W/DCP-T426W

If you already have a certificate from an external trusted CA, you can store the certificate and private key on the machine and manage them by importing and exporting. If you do not have a certificate from an external trusted CA, create a Certificate Signing Request (CSR), send it to a CA for authentication, and install the returned certificate on your machine.

- [Create a Certificate Signing Request \(CSR\)](#)
- [Install a Certificate on Your Machine](#)

Create a Certificate Signing Request (CSR)

Related Models: DCP-T420W/DCP-T425W/DCP-T426W

A Certificate Signing Request (CSR) is a request sent to a Certificate Authority (CA) to authenticate the credentials contained within the certificate.

We recommend installing a Root Certificate from the CA on your computer before creating the CSR.

1. Start your web browser.
2. Type "https://machine's IP address" in your browser's address bar (where "machine's IP address" is the machine's IP address).

For example:

https://192.168.1.2



If you are using a Domain Name System or enable a NetBIOS name, you can type another name, such as "SharedPrinter" instead of the IP address.

For example:

https://SharedPrinter

If you enable a NetBIOS name, you can also use the node name.

For example:

https://brnxxxxxxxxxxxx

The NetBIOS name can be found in the Network Configuration Report.

3. If required, type the password in the **Login** field, and then click **Login**.



The default password to manage this machine's settings is located on the back of the machine and marked "Pwd".

4. Go to the navigation menu, and then click **Network > Security > Certificate**.



Start from , if the navigation menu is not shown on the left side of the screen.

5. Click **Create CSR**.
6. Type a **Common Name** (required) and add other information about your **Organization** (optional).



- Your company details are required so that a CA can confirm your identity and verify it to the outside world.
- The length of the **Common Name** must be less than 64 bytes. Enter an identifier, such as an IP address, node name, or domain name to use when accessing this printer through SSL/TLS communication. The node name is displayed by default. The **Common Name** is required.
- A warning will appear if you type a different name in the URL than the Common Name that was used for the certificate.
- The length of the **Organization**, the **Organization Unit**, the **City/Locality** and the **State/Province** must be less than 64 bytes.
- The **Country/Region** should be a two character ISO 3166 country code.
- If you are configuring an X.509v3 certificate extension, select the **Configure extended partition** checkbox, and then select **Auto (Register IPv4)** or **Manual**.

7. Select your setting from the **Public Key Algorithm** drop-down list. The default setting is **RSA(2048bit)**.
8. Select your setting from the **Digest Algorithm** drop-down list. The default setting is **SHA256**.
9. Click **Submit**.

The CSR appears on your screen. Save the CSR as a file or copy and paste it into an online CSR form offered by a Certificate Authority.

10. Click **Save**.

11. Click ▼ next to **Save**, and then specify the location where you want to save the file.



- Follow your CA's policy regarding the method to send a CSR to your CA.
 - If you are using the Enterprise root CA of Windows Server 2008/2008 R2/2012/2012 R2/2016/2019, we recommend using the Web Server for the certificate template to securely create the Client Certificate. For more detailed information, visit support.brother.com, to see the **FAQs & Troubleshooting** page of your model. Search for "SSL".
-



Related Information

- [Create CSR and Install a Certificate from a Certificate Authority \(CA\)](#)

Related Topics:

- [Access Web Based Management](#)
-

Install a Certificate on Your Machine

Related Models: DCP-T420W/DCP-T425W/DCP-T426W

When you receive a certificate from a CA, follow the steps below to install it into the print server:

Only a certificate issued with your machine's CSR can be installed onto the machine. When you want to create another CSR, make sure that the certificate is installed before creating another CSR. Create another CSR only after installing the certificate on the machine. If you do not, the CSR you create before installing will be invalid.

1. Start your web browser.
2. Type "https://machine's IP address" in your browser's address bar (where "machine's IP address" is the machine's IP address).

For example:

https://192.168.1.2



If you are using a Domain Name System or enable a NetBIOS name, you can type another name, such as "SharedPrinter" instead of the IP address.

For example:

https://SharedPrinter

If you enable a NetBIOS name, you can also use the node name.

For example:

https://brnxxxxxxxxxxxx

The NetBIOS name can be found in the Network Configuration Report.

3. If required, type the password in the **Login** field, and then click **Login**.



The default password to manage this machine's settings is located on the back of the machine and marked "Pwd".

4. Go to the navigation menu, and then click **Network > Security > Certificate**.



Start from , if the navigation menu is not shown on the left side of the screen.

5. Click **Install Certificate**.
6. Browse to the file that contains the certificate issued by the CA, and then click **Submit**.

The certificate has been created successfully and saved in your machine's memory successfully.

To use SSL/TLS communication, the Root Certificate from the CA must be installed on your computer. Contact your network administrator.



Related Information

- [Create CSR and Install a Certificate from a Certificate Authority \(CA\)](#)

Related Topics:

- [Access Web Based Management](#)

Import and Export the Certificate and Private Key

Related Models: DCP-T420W/DCP-T425W/DCP-T426W

Store the certificate and private key on your machine and manage them by importing and exporting them.

- [Import a Certificate and Private Key](#)
- [Export the Certificate and Private Key](#)

Import a Certificate and Private Key

Related Models: DCP-T420W/DCP-T425W/DCP-T426W

1. Start your web browser.
2. Type "https://machine's IP address" in your browser's address bar (where "machine's IP address" is the machine's IP address).

For example:

https://192.168.1.2



If you are using a Domain Name System or enable a NetBIOS name, you can type another name, such as "SharedPrinter" instead of the IP address.

For example:

https://SharedPrinter

If you enable a NetBIOS name, you can also use the node name.

For example:

https://brnxxxxxxxxxxxx

The NetBIOS name can be found in the Network Configuration Report.

3. If required, type the password in the **Login** field, and then click **Login**.



The default password to manage this machine's settings is located on the back of the machine and marked "Pwd".

4. Go to the navigation menu, and then click **Network > Security > Certificate**.



Start from ☰, if the navigation menu is not shown on the left side of the screen.

5. Click **Import Certificate and Private Key**.
6. Browse to the file you want to import.
7. Type the password if the file is encrypted, and then click **Submit**.

The certificate and private key are imported to your machine.



Related Information

- [Import and Export the Certificate and Private Key](#)

Related Topics:

- [Access Web Based Management](#)

Export the Certificate and Private Key

Related Models: DCP-T420W/DCP-T425W/DCP-T426W

1. Start your web browser.
2. Type "https://machine's IP address" in your browser's address bar (where "machine's IP address" is the machine's IP address).

For example:

https://192.168.1.2



If you are using a Domain Name System or enable a NetBIOS name, you can type another name, such as "SharedPrinter" instead of the IP address.

For example:

https://SharedPrinter

If you enable a NetBIOS name, you can also use the node name.

For example:

https://brnxxxxxxxxxxxx

The NetBIOS name can be found in the Network Configuration Report.

3. If required, type the password in the **Login** field, and then click **Login**.



The default password to manage this machine's settings is located on the back of the machine and marked "Pwd".

4. Go to the navigation menu, and then click **Network > Security > Certificate**.



Start from , if the navigation menu is not shown on the left side of the screen.

5. Click **Export** shown with **Certificate List**.
6. Enter the password if you want to encrypt the file.
If a blank password is used, the output is not encrypted.
7. Enter the password again for confirmation, and then click **Submit**.
8. Click ▼ next to **Save**, and then specify the location where you want to save the file.

The certificate and private key are exported to your computer.

You can also import the certificate to your computer.



Related Information

- [Import and Export the Certificate and Private Key](#)

Related Topics:

- [Access Web Based Management](#)

Manage Multiple Certificates

Related Models: DCP-T420W/DCP-T425W/DCP-T426W

The Multiple Certificate feature allows you to use Web Based Management to manage each certificate installed on your machine. In Web Based Management, navigate to the **Certificate** screen to view certificate content, delete, or export your certificates.

| | Maximum Number of Certificates Stored on Brother Machine |
|---|--|
| Self-signed Certificate or Certificate Issued by a CA | 2 |

We recommend storing fewer certificates than allowed, reserving an empty spot in case of certificate expiration. When a certificate expires, import a new certificate into the reserved spot, and then delete the expired certificate. This ensures that you avoid configuration failure.

Related Information

- [Configure Certificates for Device Security](#)

Use SSL/TLS

Related Models: DCP-T420W/DCP-T425W/DCP-T426W

- [Introduction to SSL/TLS](#)
- [Manage Your Network Machine Securely Using SSL/TLS](#)
- [Print Documents Securely Using SSL/TLS](#)

Introduction to SSL/TLS

Related Models: DCP-T420W/DCP-T425W/DCP-T426W

Secure Socket Layer (SSL) or Transport Layer Security (TLS) is an effective method of protecting data sent over a local or wide area network (LAN or WAN). It works by encrypting data, such as a print job, sent over a network, so anyone trying to capture it will not be able to read it.

SSL/TLS will work with other forms of security such as WPA keys and firewalls.



Related Information

- [Use SSL/TLS](#)
 - [Brief History of SSL/TLS](#)
 - [Benefits of Using SSL/TLS](#)

Brief History of SSL/TLS

Related Models: DCP-T420W/DCP-T425W/DCP-T426W

SSL/TLS was originally created to secure web traffic information, particularly data sent between web browsers and servers. For example, when you use Internet Explorer for Internet Banking and you see https:// and the little padlock icon in the web browser, you are using SSL. SSL grew to work with additional applications, such as Telnet, printer, and FTP software, in order to become a universal solution for online security. Its original design intentions are still being used today by many online retailers and banks to secure sensitive data, such as credit card numbers, customer records, etc.

SSL/TLS uses extremely high levels of encryption and is trusted by banks all over the world.



Related Information

- [Introduction to SSL/TLS](#)

Benefits of Using SSL/TLS

Related Models: DCP-T420W/DCP-T425W/DCP-T426W

The primary benefit of using SSL/TLS is to guarantee secure printing over an IP network by restricting unauthorised users from reading data sent to the machine. SSL's key selling point is that it can be used to print confidential data securely. For example, an HR department in a large company may be printing wage slips on a regular basis. Without encryption, the data contained on these wages slips can be read by other network users. However, with SSL/TLS, anyone trying to capture the data will see a confusing page of code and not the actual wage slip.



Related Information

- [Introduction to SSL/TLS](#)

Manage Your Network Machine Securely Using SSL/TLS

Related Models: DCP-T420W/DCP-T425W/DCP-T426W

- [Configure a Certificate for SSL/TLS and Available Protocols](#)
- [Access Web Based Management Using SSL/TLS](#)
- [Install the Self-signed Certificate for Windows users with Administrator Rights](#)
- [Configure Certificates for Device Security](#)

Configure a Certificate for SSL/TLS and Available Protocols

Related Models: DCP-T420W/DCP-T425W/DCP-T426W

Configure a certificate on your machine using Web Based Management before you use SSL/TLS communication.

1. Start your web browser.
2. Type "https://machine's IP address" in your browser's address bar (where "machine's IP address" is the machine's IP address).

For example:

https://192.168.1.2



If you are using a Domain Name System or enable a NetBIOS name, you can type another name, such as "SharedPrinter" instead of the IP address.

For example:

https://SharedPrinter

If you enable a NetBIOS name, you can also use the node name.

For example:

https://brnxxxxxxxxxxxx

The NetBIOS name can be found in the Network Configuration Report.

3. If required, type the password in the **Login** field, and then click **Login**.



The default password to manage this machine's settings is located on the back of the machine and marked "Pwd".

4. Go to the navigation menu, and then click **Network > Network > Protocol**.



Start from , if the navigation menu is not shown on the left side of the screen.

5. Click **HTTP Server Settings**.
6. Select the certificate you want to configure from the **Select the Certificate** drop-down list.
7. Click **Submit**.
8. Click **Yes** to restart your print server.



Related Information

- [Manage Your Network Machine Securely Using SSL/TLS](#)

Related Topics:

- [Access Web Based Management](#)
- [Print Documents Securely Using SSL/TLS](#)

Access Web Based Management Using SSL/TLS

Related Models: DCP-T420W/DCP-T425W/DCP-T426W

To manage your network machine securely, you must use management utilities with security protocols.



- To use HTTPS protocol, HTTPS must be enabled on your machine. The HTTPS protocol is enabled by default.
- You can change the HTTPS protocol settings using the Web Based Management screen.

1. Start your web browser.
2. Type "https://machine's IP address" in your browser's address bar (where "machine's IP address" is the machine's IP address).

For example:

https://192.168.1.2

3. If required, type the password in the **Login** field, and then click **Login**.



The default password to manage this machine's settings is located on the back of the machine and marked "Pwd".

4. You can now access the machine using HTTPS.



Related Information

- [Manage Your Network Machine Securely Using SSL/TLS](#)





Related Topics:

- [Access Web Based Management](#)

Install the Self-signed Certificate for Windows users with Administrator Rights

Related Models: DCP-T420W/DCP-T425W/DCP-T426W

The following steps are for Microsoft Internet Explorer. If you use another web browser, consult the documentation for your web browser to get help with installing certificates.

1. Do one of the following:
 - Windows 10, Windows Server 2016, and Windows Server 2019
Click  > **Windows Accessories**.
 - Windows 8.1
Right-click the  (**Internet Explorer**) icon on the taskbar.
 - Windows Server 2012 and Windows Server 2012 R2
Click  (**Internet Explorer**), and then right-click the  (**Internet Explorer**) icon that appears on the taskbar.
 - Windows 7 and Windows Server 2008
Click  (**Start**) > **All Programs**.
2. Right-click **Internet Explorer**, and then click **Run as administrator**.



If the **More** option appears, click **More**.

If the **User Account Control** screen appears, click **Yes**.

3. Type "https://machine's IP address" in your browser's address bar to access your machine (where "machine's IP address" is the machine's IP address or the node name that you assigned for the certificate).
4. Click **More information**.
5. Click **Go on to the webpage (not recommended)**.
6. Click **Certificate error**, and then click **View certificates**.

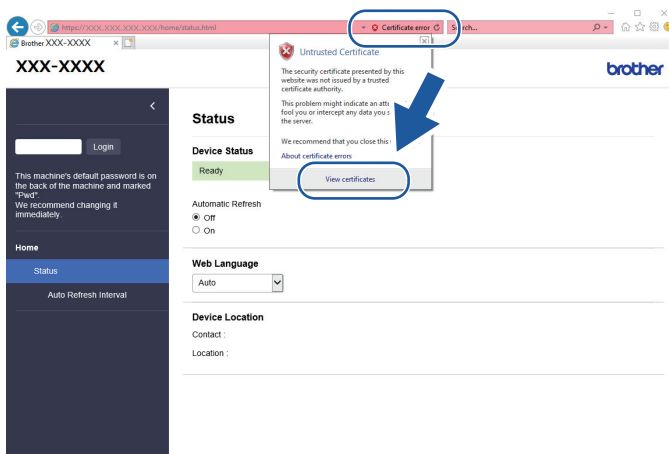

7. Click **Install Certificate...**
8. When the **Certificate Import Wizard** appears, click **Next**.
9. Select **Place all certificates in the following store**, and then click **Browse...**
10. Select **Trusted Root Certification Authorities**, and then click **OK**.

-
11. Click **Next**.
 12. Click **Finish**.
 13. Click **Yes**, if the fingerprint (thumbprint) is correct.
 14. Click **OK**.



Related Information

- [Manage Your Network Machine Securely Using SSL/TLS](#)
-

Print Documents Securely Using SSL/TLS

Related Models: DCP-T420W/DCP-T425W/DCP-T426W

- [Print Documents Using SSL/TLS](#)
- [Configure Certificates for Device Security](#)
- [Configure a Certificate for SSL/TLS and Available Protocols](#)

Print Documents Using SSL/TLS

Related Models: DCP-T420W/DCP-T425W/DCP-T426W

To print documents securely with IPP protocol, use the IPPS protocol.

1. Start your web browser.
2. Type "https://machine's IP address" in your browser's address bar (where "machine's IP address" is the machine's IP address).

For example:

https://192.168.1.2



If you are using a Domain Name System or enable a NetBIOS name, you can type another name, such as "SharedPrinter" instead of the IP address.

For example:

https://SharedPrinter

If you enable a NetBIOS name, you can also use the node name.

For example:

https://brnxxxxxxxxxxxx

The NetBIOS name can be found in the Network Configuration Report.

3. If required, type the password in the **Login** field, and then click **Login**.



The default password to manage this machine's settings is located on the back of the machine and marked "Pwd".

4. Go to the navigation menu, and then click **Network > Network > Protocol**.



Start from , if the navigation menu is not shown on the left side of the screen.

5. Make sure the **IPP** checkbox is selected.



If the **IPP** checkbox is not selected, select the **IPP** checkbox, and then click **Submit**.

Restart your machine to activate the configuration.

After the machine restarts, return to the machine's web page, go to the navigation menu, and then click **Network > Protocol**.

6. Click **HTTP Server Settings**.
7. Select the **HTTPS(Port 443)** checkbox in the **IPP**, and then click **Submit**.
8. Restart your machine to activate the configuration.

Communication using IPPS cannot prevent unauthorised access to the print server.



Related Information

- [Print Documents Securely Using SSL/TLS](#)

Related Topics:

- [Access Web Based Management](#)

Mobile Connect

Related Models: DCP-T420W/DCP-T425W/DCP-T426W

- [Mopria™ Print Service and Mopria™ Scan](#)
- [Brother iPrint&Scan Overview for Mobile Devices](#)
- [Print an Email Attachment](#)

Mopria™ Print Service and Mopria™ Scan

Related Models: DCP-T420W/DCP-T425W/DCP-T426W

Mopria™ Print Service is a print feature and Mopria™ Scan is a scan feature on Android™ mobile devices developed by the Mopria Alliance™. With this service, you can connect to the same network as your machine to print and scan without additional setup.

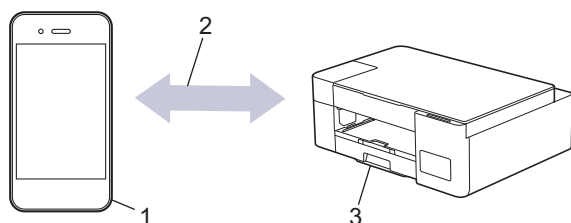

1. Android™ Mobile Device
2. Wi-Fi® Connection
3. Your Machine

You must download the Mopria™ Print Service or Mopria™ Scan from Google Play™ and install it on your Android™ device. Before using this service, you must turn it on.

Related Information

- [Mobile Connect](#)

Brother iPrint&Scan

- [Brother iPrint&Scan Overview for Windows and Mac](#)
- [Brother iPrint&Scan Overview for Mobile Devices](#)

Brother iPrint&Scan Overview for Windows and Mac

Use Brother iPrint&Scan for Windows and Mac to print and scan from your computer.

The following screen shows an example of Brother iPrint&Scan for Windows. The actual screen may differ depending on the version of the application.

- For Windows
Go to your model's **Downloads** page at support.brother.com to download the latest application.
- For Mac
Download and install Brother iPrint&Scan from the App Store.

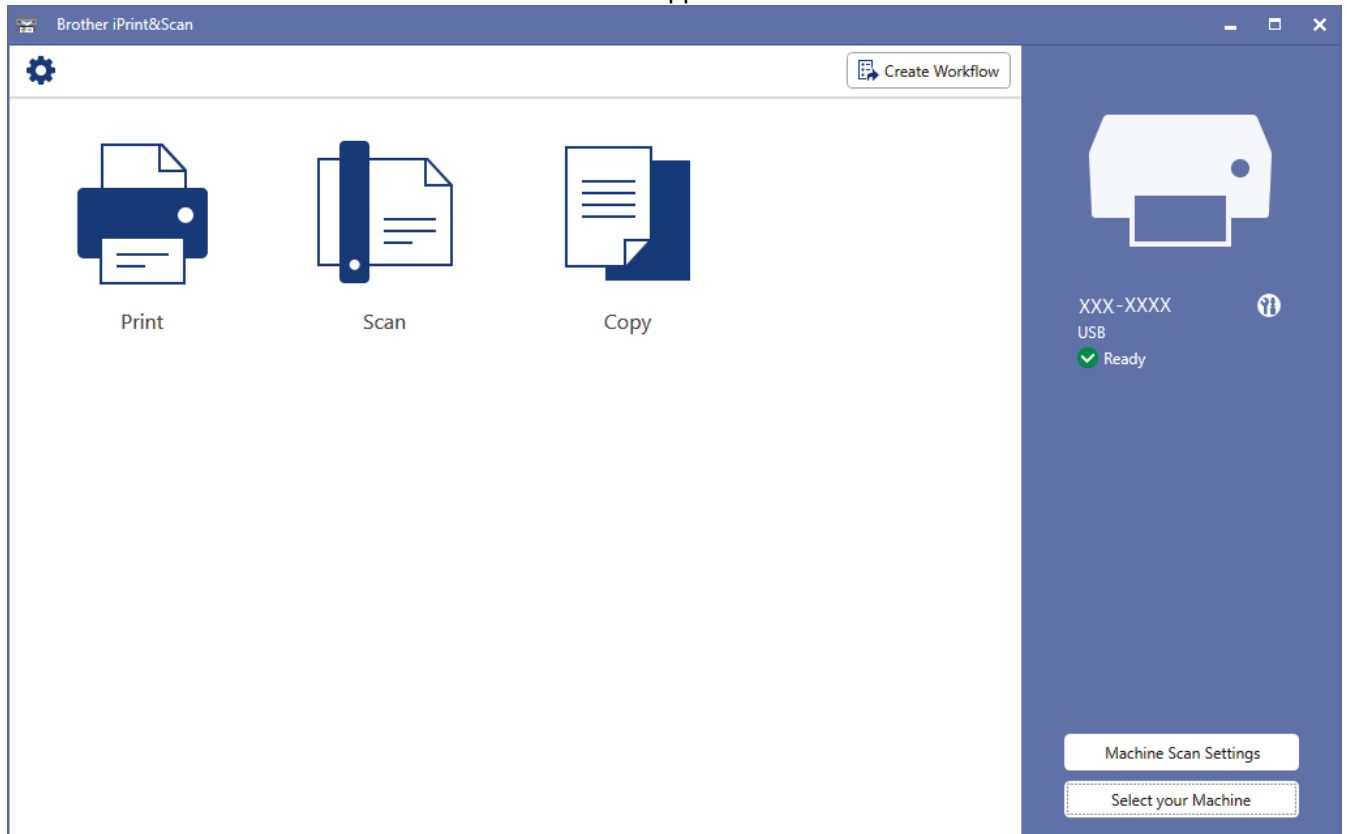

If prompted, install the driver and software necessary to use your machine. Download the installer from your model's **Downloads** page at support.brother.com.

✓ Related Information

- [Brother iPrint&Scan](#)

Related Topics:

- [Scan Using Brother iPrint&Scan \(Windows/Mac\)](#)
- [Copy Using Brother iPrint&Scan](#)

Brother iPrint&Scan Overview for Mobile Devices

Related Models: DCP-T420W/DCP-T425W/DCP-T426W

Use Brother iPrint&Scan to print and scan from various mobile devices.

- For Android™ Devices

Brother iPrint&Scan allows you to use features of your Brother machine directly from your Android™ device.

Download and install Brother iPrint&Scan from the Google Play™ Store app.

- For all iOS supported devices including iPhone, iPad and iPod touch

Brother iPrint&Scan allows you to use features of your Brother machine directly from your iOS device.

Download and install Brother iPrint&Scan from the App Store.

For more detailed information, visit support.brother.com/ips.

NOTE

You can also use Brother Mobile Connect application to print and scan on your mobile device.



Related Information

- [Brother iPrint&Scan](#)

Related Topics:

- [Configure Your Machine for a Wireless Network Using the Setup Wizard from Your Mobile Device](#)

Troubleshooting

If you think there is a problem with your machine, first check each of the items below, then try to identify the problem, and follow our troubleshooting tips.

You can correct most problems yourself. If you need additional help, visit support.brother.com for the latest FAQs and troubleshooting tips:

1. Visit support.brother.com.
2. Click **FAQs & Troubleshooting** and search for your model name.

First, check the following:

- The machine's power cord is connected correctly and the machine's power is on.
- All of the machine's protective parts have been removed.
- The Jam Clear Cover is fully closed.
- Paper is inserted correctly in the paper tray.
- The interface cables are securely connected to the machine and the computer, or the wireless connection is set up on both the machine and your computer.
- (For network models) The access point (for wireless), router, or hub is turned on and its link indicator is blinking.

If you did not solve the problem with the checks, identify the problem by checking the LED patterns and indications, and then see *Related Information*.



Related Information

- [Error and Maintenance LED Indications](#)
- [Printer Jam or Paper Jam](#)
- [If You Are Having Difficulty with Your Machine](#)
- [Check the Machine Information](#)
- [Reset Your Machine](#)

Related Topics:

- [Paper Handling and Printing Problems](#)
- [Other Problems](#)
- [Network Problems](#)



Error and Maintenance LED Indications

As with any sophisticated office product, errors may occur and supply items may have to be replaced. If this happens, your machine identifies the error or required routine maintenance and indicates this with the LEDs on the control panel. The LED indications are explained in this table.





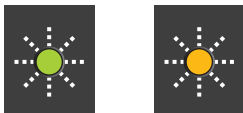

You can correct most errors and perform routine maintenance yourself. If you need more tips, go to your model's [FAQs & Troubleshooting](#) page at support.brother.com.

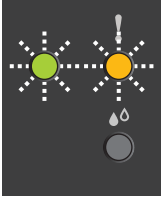

Related Information references are at the bottom of this page.

| LED | Description |
|---|----------------------|
|  | The LED is off. |
|  | The LED is lit. |
|  | The LED is blinking. |

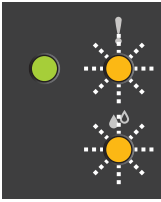
| LED | Status | Cause | Action |
|---|-------------------|---|--|
|  | Tray not detected | The paper tray is not completely inserted. | Slowly push the paper tray completely into the machine. |
| | | Paper or a foreign object has prevented the paper tray from being inserted correctly. | Pull the paper tray out of the machine, and remove the jammed paper or foreign object. If you cannot find or remove the jammed paper, see <i>Related Information: Printer Jam or Paper Jam</i> . |
| | No paper fed | The machine is out of paper or paper is not correctly loaded in the paper tray. | Do one of the following: <ul style="list-style-type: none"> Refill the paper tray, and then press Mono Start or Colour Start. Remove and reload the paper, and then press Mono Start or Colour Start. See <i>Related Information: Load Paper</i> . |
| | | The paper was not inserted in the centre position of the manual feed slot. | Remove the paper and reinsert it in the centre of the manual feed slot, and then press Mono Start or Colour Start . See <i>Related Information: Load Paper in the Manual Feed Slot</i> . |
| | | The paper in the manual feed slot does not stay straight when fed. | Using both hands, adjust the manual feed slot paper guides to make sure there is no gap between them and the paper, and then press Mono Start or Colour Start . See <i>Related Information: Load Paper in the Manual Feed Slot</i> . |

| LED | Status | Cause | Action |
|--|------------------|--|---|
| | | The Jam Clear Cover is not closed correctly. | Make sure the Jam Clear Cover is closed evenly at both ends. <i>See Related Information: Paper is Jammed Inside the Machine.</i> |
| | | Paper dust has accumulated on the surface of the paper pick-up rollers. | Clean the paper pick-up rollers. <i>See Related Information: Clean the Paper Pick-up Rollers.</i> |
|  <p>(blinking simultaneously)</p> | Paper jam | The paper is jammed in the machine. | Gently remove the jammed paper. <i>See Related Information: Printer Jam or Paper Jam.</i> Make sure the paper guides are set to the correct paper size. After completing these actions, press  (Stop). |
| | | More than one sheet of paper was placed in the manual feed slot. -OR- Another sheet of paper was placed in the manual feed slot before both the Power LED and the Warning LED light up. | Do not put more than one sheet of paper in the manual feed slot at any one time. Wait until both the Power LED and the Warning LED light up to load another sheet of paper before you feed the next sheet of paper in the manual feed slot. After checking the above, press Mono Start or Colour Start . <i>See Related Information: Load Paper in the Manual Feed Slot.</i> |
| | | Paper dust has accumulated on the surface of the paper pick-up rollers. | Clean the paper pick-up rollers. <i>See Related Information: Clean the Paper Pick-up Rollers.</i> |
|  | Wrong paper size | The paper size setting does not match the size of paper in the tray. -OR- You did not set the paper guides in the tray to the indicators for the paper size you are using. | If you are printing from your computer, make sure the paper size you selected in the printer driver or in the application you use to print matches the size of paper in the tray. <i>See Related Information: Print Settings (Windows).</i> |
|  | Check ink level | A certain amount of ink is consumed during this operation. Look through the window of the ink tank to confirm the actual amount of remaining ink. | If the remaining ink level is at or below the lower line under the minimum fill mark, refill the ink tank. When finished, press  (Stop). <i>See Related Information: Refill the Ink Tanks.</i> |
|  | Out of memory | The machine's memory is full. | If a copy operation is in progress: <ul style="list-style-type: none"> Press  (Stop) and wait until the other operations that are in progress finish, and then try again. Press Mono Start or Colour Start to copy the pages scanned so far. |

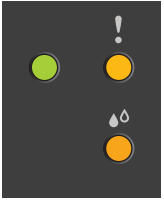
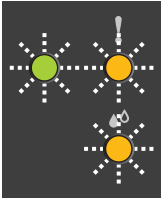
| LED | Status | Cause | Action |
|---|--|---|--|
| | (Blinking three times) Operation rejected | The machine cannot perform this operation now. | Wait a few minutes, and then try again. |
|  | InkBox full | The ink absorber box is full. These components are periodic maintenance items that may require replacement after a period of time to ensure optimum performance from your Brother machine. Because these components are periodic maintenance items, the replacement is not covered under the warranty. The need to replace these items and the time period before replacement is dependent on the number of purges and flushes required to clean the ink system. These boxes acquire amounts of ink during the different purging and flushing operations. The number of times a machine purges and flushes for cleaning varies depending on different situations. For example, frequently powering the machine on and off will cause numerous cleaning cycles since the machine automatically cleans upon power up. | The ink absorber box must be replaced. Contact Brother customer service or your local Brother Authorised Service Centre to have your machine serviced. |
|  | Machine error | The machine has a mechanical problem. | Disconnect the machine from the power for several minutes, and then reconnect it. |



Related Information

- [Troubleshooting](#)

Related Topics:

- [Refill the Ink Tanks](#)
- [Load Paper](#)
- [Load Paper in the Manual Feed Slot](#)
- [Printer Jam or Paper Jam](#)
- [Clean the Paper Pick-up Rollers](#)
- [Print Settings \(Windows\)](#)
- [Paper is Jammed Inside the Machine](#)
- [LED Patterns and Indications](#)

Printer Jam or Paper Jam

Locate and remove the jammed paper.

- [Paper is Jammed Inside the Machine](#)
- [Error and Maintenance LED Indications](#)
- [Paper Handling and Printing Problems](#)

Paper is Jammed Inside the Machine

If the paper is jammed, follow these steps:

1. Unplug the machine from the electrical socket.
2. Pull the paper tray (1) completely out of the machine.

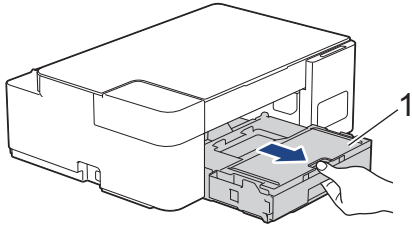

3. Slowly pull the jammed paper (1) out of the machine.

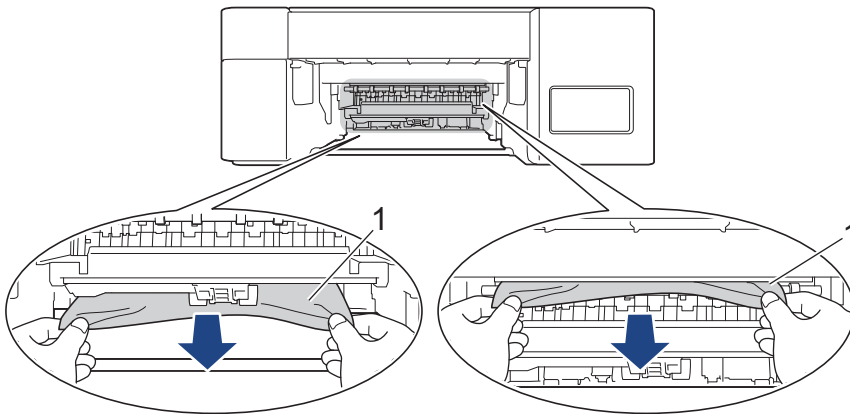

IMPORTANT

Be careful, as ink can easily get on your hands. If ink gets on your skin or clothing, immediately wash it off with soap or detergent.

4. Make sure you look carefully inside (1) for any scraps of paper.

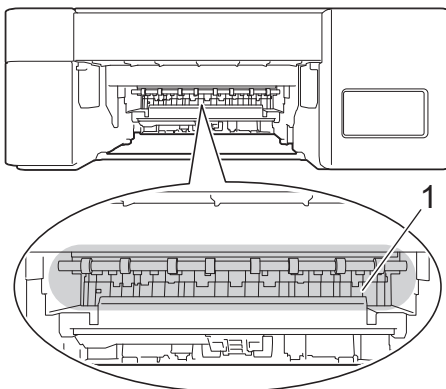

5. Push down on the Jam Clear Cover (1) on the back of the machine, and then open it (2).

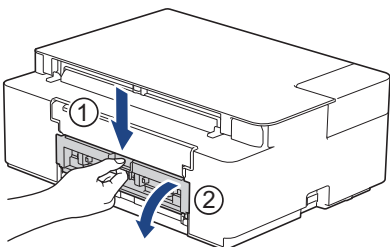

6. Slowly pull the jammed paper out of the machine.

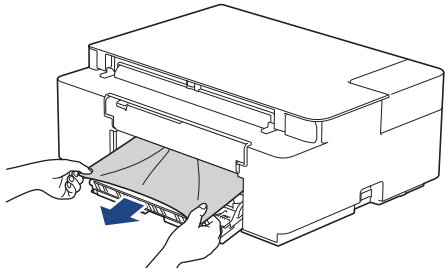

7. Close the Jam Clear Cover. Make sure the cover is closed completely.

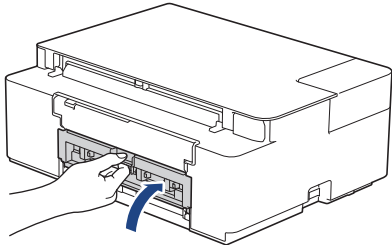

8. Push the paper tray firmly back in the machine.

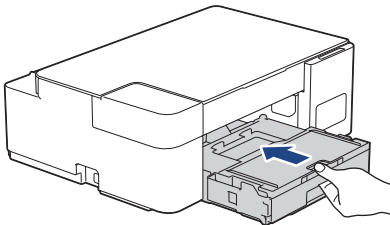

9. While holding the paper tray in the machine, pull out the paper support (1) until it locks into place, and then unfold the paper support flap (2).

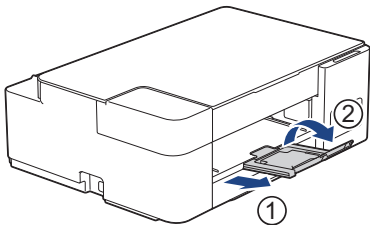

10. Reconnect the power cord.



Additional paper jam clear operations

If the **Power LED** and the **Warning LED** continue to blink and you repeatedly experience paper jams, do the following:

1. Unplug the machine from the electrical socket and open the manual feed slot cover.
2. Load one sheet of thick A4 or Letter sized paper, such as glossy paper, in the manual feed slot. Insert the paper deep into the manual feed slot.

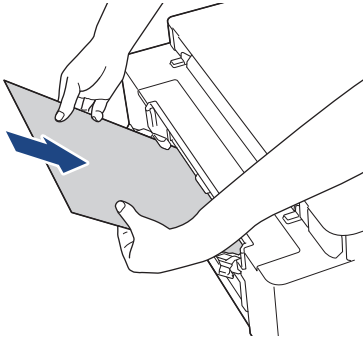

3. Re-connect the power cord.

The paper you placed in the manual feed slot will be fed through the machine and ejected. If the thick paper is pushing any jammed paper out, remove the jammed paper.

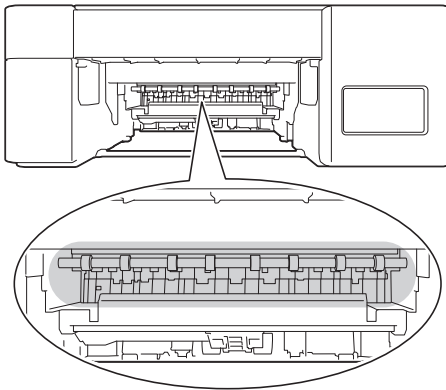

Related Information

- [Printer Jam or Paper Jam](#)

Related Topics:

- [Error and Maintenance LED Indications](#)

If You Are Having Difficulty with Your Machine



For technical help, you must contact Brother customer support.

If you think there is a problem with your machine, check the following topics. You can correct most problems yourself.

If you need additional help, go to your model's **FAQs & Troubleshooting** page at support.brother.com.

- [Paper Handling and Printing Problems](#)
- [Other Problems](#)
- [Network Problems](#)

Paper Handling and Printing Problems



If, after reading this table, you still need help, see the latest **FAQs & Troubleshooting** tips at support.brother.com.



>> [Printing Difficulties](#)

>> [Print Quality Difficulties](#)

>> [Paper Handling Difficulties](#)







Printing Difficulties

| Difficulties | Suggestions |
|--------------|--|
| No printout | <p>(Windows)</p> <p>Check that the correct printer driver has been installed and selected.</p> <p>Check to see if the machine's LEDs are indicating an error. See <i>Related Information: Error and Maintenance LED Indications</i>.</p> <p>Check that the machine is online:</p> <ul style="list-style-type: none"> Windows 10, Windows Server 2016, and Windows Server 2019 Click  > Windows System > Control Panel. In the Hardware and Sound group, click View devices and printers. Right-click the Brother XXX-XXXX Printer (where XXX-XXXX is the name of your model). Click See what's printing. If printer driver options appear, select your printer driver. Click Printer in the menu bar and make sure Use Printer Offline is not selected. Windows 8.1 Move your mouse to the lower right corner of your desktop. When the menu bar appears, click Settings > Control Panel. In the Hardware and Sound group, click View devices and printers. Right-click the Brother XXX-XXXX Printer (where XXX-XXXX is the name of your model). Click See what's printing. If printer driver options appear, select your printer driver. Click Printer in the menu bar and make sure Use Printer Offline is not selected. Windows Server 2012 R2 Click Control Panel on the Start screen. In the Hardware group, click View devices and printers. Right-click the Brother XXX-XXXX Printer (where XXX-XXXX is the name of your model). Click See what's printing. If printer driver options appear, select your printer driver. Click Printer in the menu bar and make sure Use Printer Offline is not selected. Windows Server 2012 Move your mouse to the lower right corner of your desktop. When the menu bar appears, click Settings > Control Panel. In the Hardware group, click View devices and printers. Right-click the Brother XXX-XXXX Printer (where XXX-XXXX is the name of your model). Click See what's printing. If printer driver options appear, select your printer driver. Click Printer in the menu bar and make sure Use Printer Offline is not selected. Windows 7 and Windows Server 2008 R2 Click  (Start) > Devices and Printers. Right-click Brother XXX-XXXX Printer (where XXX-XXXX is the name of your model) and click See what's printing. If printer driver options appear, select your printer driver. Click Printer in the menu bar. Make sure Use Printer Offline is not selected. Windows Server 2008 Click  (Start) > Control Panel > Hardware and Sound > Printers. Right-click Brother XXX-XXXX Printer (where XXX-XXXX is the name of your model). Make sure Use Printer Online is not listed. If it is listed, click this option to set the driver Online. |

| Difficulties | Suggestions |
|--|--|
| | <p>Look through the window of the ink tank to confirm the actual amount of remaining ink.</p> <p>If the remaining ink level is at or below the lower line under the minimum fill mark, refill the ink tank.</p> <p>See <i>Related Information: Refill the Ink Tanks</i>.</p> <p>If old, unprinted data remains in the printer driver spooler, it will prevent new print jobs from printing. Open the printer icon and delete all data as follows:</p> <ul style="list-style-type: none"> • Windows 10, Windows Server 2016, and Windows Server 2019 Click  > Windows System > Control Panel. In the Hardware and Sound group, click View devices and printers > Printers. • Windows 8.1 Move your mouse to the lower right corner of your desktop. When the menu bar appears, click Settings > Control Panel. In the Hardware and Sound group, click View devices and printers > Printers. • Windows Server 2012 R2 Click Control Panel on the Start screen. In the Hardware group, click View devices and printers > Printers. • Windows Server 2012 Move your mouse to the lower right corner of your desktop. When the menu bar appears, click Settings > Control Panel. In the Hardware group, click View devices and printers > Printers. • Windows 7 and Windows Server 2008 R2 Click /Start > Devices and Printers > Printers and Faxes. • Windows Server 2008 Click  (Start) > Control Panel > Hardware and Sound > Printers. |
| The headers or footers appear when the document is displayed on the screen but do not appear when the document is printed. | There is an unprintable area on the top and bottom of the page. Adjust the top and bottom margins in your document to allow for this. See <i>Related Information: Unprintable Area</i> . |
| Cannot perform 'Page Layout' printing. | (Windows) Check that the paper size setting in the application and in the printer driver are the same. |
| Print speed is too slow. | <p>(Windows)</p> <p>Try changing the printer driver setting. The highest resolution needs longer data processing, sending, and printing time. Try the other quality settings in the printer driver as follows:</p> <p>In the printer driver, clear the Colour Enhancement checkbox on the Advanced tab.</p> <p>Turn the Borderless feature off. Borderless printing is slower than normal printing. See <i>Related Information: Print Settings (Windows)</i>.</p> <p>Turn the Quiet Mode setting off. Print speed is slower in Quiet Mode. See <i>Related Information: Reduce Printing Noise</i>.</p> <p>Make sure the Media Type setting in the printer driver or in the application you use to print matches the type of paper you are using. See <i>Related Information: Print Settings (Windows)</i>.</p> |

Print Quality Difficulties

| Difficulties | Suggestions |
|--------------------|---|
| Poor print quality | Check the print quality. See <i>Related Information: Check the Print Quality</i> . |

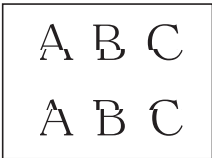
| Difficulties | Suggestions |
|--|---|
| | <p>Make sure the Media Type setting in the printer driver or in the application you use to print matches the type of paper you are using. See <i>Related Information: Print Settings (Windows)</i>.</p> <p>Make sure the ink is fresh. The following may cause ink to clog:</p> <ul style="list-style-type: none"> • The expiration date written on the bottle package has passed. • The ink bottle may not have been stored correctly before use. Store the ink bottle on a level surface in a cool, dark place. • The ink bottle cap may not be tightly secured. <p>Make sure you are using one of the recommended types of paper. See <i>Related Information: Acceptable Paper and Other Print Media</i>.</p> <p>The recommended environment for your machine is between 20°C to 33°C.</p> |
| <p>White lines appear in text or graphics.</p>  | <p>Clean the print head. See <i>Related Information: Clean the Print Head from Your Brother Machine</i>. See <i>Related Information: Clean the Print Head Using Web Based Management</i>. See <i>Related Information: Clean the Print Head from Your Computer (Windows)</i>.</p> <p>Check and adjust the print alignment. See <i>Related Information: Check the Print Alignment from Your Brother Machine, Check the Print Alignment Using Web Based Management</i>.</p> <p>Try using the recommended types of paper. See <i>Related Information: Acceptable Paper and Other Print Media</i>.</p> <p>To prolong print head life, provide the best ink economy and maintain print quality, we do not recommend frequently unplugging the machine and/or leaving the machine unplugged for extended periods of time. We recommend using  (Stop) to power down the machine. Using  (Stop) allows minimal power to the machine, resulting in periodic, but less frequent, cleaning of the print head.</p> |
| <p>Dark lines appear at regular intervals.</p>  | <p>Check and adjust the print alignment. See <i>Related Information: Check the Print Alignment from Your Brother Machine</i>. See <i>Related Information: Check the Print Alignment Using Web Based Management</i>.</p> |
| <p>The machine prints blank pages.</p> | <p>Check the print quality. See <i>Related Information: Check the Print Quality</i>.</p> <p>To prolong print head life, provide the best ink economy and maintain print quality, we do not recommend frequently unplugging the machine and/or leaving the machine unplugged for extended periods of time. We recommend using  (Stop) to power down the machine. Using  (Stop) allows minimal power to the machine, resulting in periodic, but less frequent, cleaning of the print head.</p> |
| <p>Characters and lines are blurred.</p>  | <p>Check the printing alignment. See <i>Related Information: Check the Print Alignment from Your Brother Machine</i>. See <i>Related Information: Check the Print Alignment Using Web Based Management</i>.</p> <p>Change the print options. See <i>Related Information: Change the Print Options to Improve Your Print Results</i>.</p> |
| <p>Printed text or images are skewed.</p> | <p>Make sure the paper is loaded correctly in the paper tray and the paper guides are adjusted correctly.</p> |

| Difficulties | Suggestions |
|--|---|
| | See <i>Related Information: Load Paper</i> . |
| | Make sure the Jam Clear Cover is closed correctly. |
| There are smudges or stains at the top centre of the printed page. | Make sure the paper is not too thick or curled. See <i>Related Information: Acceptable Paper and Other Print Media</i> . |
| Printing appears dirty or ink seems to run. | Make sure you are using the recommended types of paper. Do not handle the paper until the ink is dry. See <i>Related Information: Acceptable Paper and Other Print Media</i> . |
| | Make sure the printing surface is face down in the paper tray. |
| | If you are using photo paper, make sure the glossy side of the photo paper is face down in the tray and you have set the correct paper type. If you are printing a photo from your computer, set the Media Type in the printer driver or in the application you use to print. |
| Ink is smudged or wet when using glossy photo paper. | Be sure to check the front and back of the paper. Place the glossy surface (printing surface) face down. |
| | If you use glossy photo paper, make sure the paper type setting is correct. |
| Stains appear on the reverse side or at the bottom of the page. | Make sure the printer platen is not dirty with ink. See <i>Related Information: Clean the Machine's Printer Platen</i> . |
| | Make sure you are using the paper support flap. See <i>Related Information: Load Paper</i> . |
| | Make sure the paper feed rollers are not dirty with ink. See <i>Related Information: Clean the Paper Feed Rollers</i> . |
| The printouts are wrinkled. | (Windows) In the printer driver, select the Advanced tab, click Other Print Options , and then click Advanced Colour Settings . Clear the Bi-Directional Printing checkbox. |

Paper Handling Difficulties

| Difficulties | Suggestions |
|--------------------------------------|--|
| The machine does not feed paper. | Make sure the paper tray is pushed in all the way until it locks into place. |
| | Make sure the Jam Clear Cover at the back of the machine is closed. |
| | If the Power LED and the Warning LED are still blinking, see <i>Related Information: Error and Maintenance LED Indications</i> . |
| | If the paper tray is empty, load a new stack of paper into the paper tray. |
| | If there is paper in the paper tray, make sure it is straight. If the paper is curled, straighten it. Sometimes it is helpful to remove the paper, turn the stack over and put it back in the paper tray. |
| | Reduce the amount of paper in the paper tray, and then try again. |
| | Clean the paper pick-up rollers. See <i>Related Information: Clean the Paper Pick-up Rollers</i> . |
| | Make sure that the paper is within specifications for the machine. See <i>Related Information: Paper Weight and Thickness</i> . |
| Photo paper does not feed correctly. | When you print on photo paper, load one extra sheet of the same photo paper in the paper tray. |
| Machine feeds multiple pages. | <ul style="list-style-type: none"> • Make sure the paper is loaded correctly in the paper tray. • Remove all the paper from the tray and fan the stack of paper well, then put it back in the tray. • Make sure you do not push the paper in too far. |

| Difficulties | Suggestions |
|--|---|
| | <p>See <i>Related Information: Load Paper</i>.</p> <p>Make sure the Jam Clear Cover is closed correctly. See <i>Related Information: Printer Jam or Paper Jam</i>.</p> <p>Make sure the Base Pad in the paper tray is not dirty. See <i>Related Information: Clean the Base Pad</i>.</p> |
| There is a paper jam. | <p>See <i>Related Information: Printer Jam or Paper Jam</i>. Make sure the paper guides are set to the correct paper size.</p> <p>Use the jam prevention settings. For copying: See <i>Related Information: Change the Print Options to Improve Your Print Results</i>. For printing: See <i>Related Information: Change the Print Options to Improve Your Print Results</i>. See <i>Related Information: Prevent Smudged Printouts and Paper Jams (Windows)</i>.</p> |
| The paper jams when you use 2-sided print. | <p>If paper jams occur frequently during 2-sided printing, the paper feed rollers may be stained with ink. Clean the paper feed rollers. See <i>Related Information: Clean the Paper Feed Rollers</i>.</p> |



Related Information

- [If You Are Having Difficulty with Your Machine](#)

Related Topics:

- [Troubleshooting](#)
- [Refill the Ink Tanks](#)
- [Unprintable Area](#)
- [Check the Print Quality](#)
- [Acceptable Paper and Other Print Media](#)
- [Clean the Print Head from Your Brother Machine](#)
- [Clean the Print Head Using Web Based Management](#)
- [Clean the Print Head from Your Computer \(Windows\)](#)
- [Load Paper](#)
- [Clean the Machine's Printer Platen](#)
- [Clean the Paper Feed Rollers](#)
- [Clean the Paper Pick-up Rollers](#)
- [Printer Jam or Paper Jam](#)
- [Paper Weight and Thickness](#)
- [Print Settings \(Windows\)](#)
- [Prevent Smudged Printouts and Paper Jams \(Windows\)](#)
- [Clean the Base Pad](#)
- [Change the Print Options to Improve Your Print Results](#)
- [Reduce Printing Noise](#)
- [Error and Maintenance LED Indications](#)
- [Check the Print Alignment from Your Brother Machine](#)
- [Check the Print Alignment Using Web Based Management](#)

Other Problems

- >> [Copying Difficulties](#)
- >> [Scanning Difficulties](#)
- >> [Software Difficulties](#)

Copying Difficulties

| Difficulties | Suggestions |
|--|---|
| Black marks or spots appear in copies. | Black marks or spots on copies are typically caused by dirt or correction fluid on the scanner glass. Clean the scanner glass and white plastic above it. <i>See Related Information: Clean the Scanner.</i> |
| Copies are blank. | Make sure you are loading the document correctly. <i>See Related Information: Load Documents on the Scanner Glass.</i> |
| Fit to Page does not work correctly. | Make sure the document is not skewed on the scanner glass. Reposition the document and try again. |
| Copy speed is too slow. | To copy with normal quality, briefly press Mono Start or Colour Start (do not press and hold). If you press and hold Mono Start or Colour Start for two seconds, the machine makes a copy of the best quality, which will take more time. |

Scanning Difficulties

| Difficulties | Suggestions |
|---|--|
| TWAIN or WIA errors appear when starting to scan. (Windows) | Make sure the Brother TWAIN or WIA driver is selected as the primary source in your scanning application. For example, in Nuance™ PaperPort™ 14SE, click Desktop > Scan Settings > Select to choose the Brother TWAIN/WIA driver. |
| OCR does not work. | Try increasing the scanning resolution. |

Software Difficulties

| Difficulties | Suggestions |
|---|--|
| Cannot print. | Uninstall the drivers (Windows) and the Brother software and reinstall the latest version of both. |
| "The device is busy." appears on the computer screen. | Make sure the machine's LEDs are not indicating any errors. |

✓ Related Information

- [If You Are Having Difficulty with Your Machine](#)

Related Topics:

- [Troubleshooting](#)
- [Clean the Scanner](#)
- [Load Documents on the Scanner Glass](#)
- [Change the Print Options to Improve Your Print Results](#)

Network Problems

Related Models: DCP-T420W/DCP-T425W/DCP-T426W

- [Use the Network Connection Repair Tool \(Windows\)](#)
- [Check the Brother Machine's Network Settings](#)
- [If You Are Having Difficulty with Your Machine's Network](#)

Use the Network Connection Repair Tool (Windows)

Related Models: DCP-T420W/DCP-T425W/DCP-T426W

Use the Network Connection Repair Tool to fix the Brother machine's network settings. It will assign the correct IP address and Subnet Mask.

Make sure your machine is turned on and is connected to the same network as your computer.

1. Launch  (**Brother Utilities**), and then click the drop-down list and select your model name (if not already selected).
2. Click **Tools** in the left navigation bar, and then click **Network Connection Repair Tool**.
3. Follow the on-screen instructions.
4. Check the diagnosis by printing the Network Configuration Report.



The Network Connection Repair Tool will start automatically if you select the **Enable Connection Repair Tool** option in the Status Monitor. Right-click the Status Monitor screen, and then click **Other Settings > Enable Connection Repair Tool**. This is not recommended when your network administrator has set the IP address to Static, since it will automatically change the IP address.

If the correct IP address and the Subnet Mask are still not assigned even after using the Network Connection Repair Tool, ask your network administrator for this information.



Related Information

- [Network Problems](#)

Related Topics:

- [Print the Network Configuration Report](#)
- [If You Are Having Difficulty with Your Machine's Network](#)

Check the Brother Machine's Network Settings

Related Models: DCP-T420W/DCP-T425W/DCP-T426W

- [Print the Network Configuration Report](#)
- [Configure Network Settings](#)

If You Are Having Difficulty with Your Machine's Network

Related Models: DCP-T420W/DCP-T425W/DCP-T426W



For technical help, you must contact Brother customer support.

If you think there is a problem with your machine, check the following topics. You can correct most problems yourself.

If you need additional help, go to your model's **FAQs & Troubleshooting** page at support.brother.com.

>> [I Cannot Complete the Wireless Network Setup Configuration](#)

>> [My Brother Machine Cannot Print or Scan over the Network](#)

>> [I Want to Check that My Network Devices are Working Correctly](#)

I Cannot Complete the Wireless Network Setup Configuration

Turn your wireless router off and back on. Then, try to configure the wireless settings again. If you are unable to resolve the problem, follow the instructions below:

Investigate the problem using the WLAN Report.

| Cause | Action | Interface |
|---|--|-----------|
| Your security settings (SSID/ Network Key) are not correct. | <p>Confirm the security settings using Wireless Setup Helper. For more information and to download the utility, go to your model's Downloads page at support.brother.com.</p> <p>Select and confirm that you are using the correct security settings.</p> <ul style="list-style-type: none"> - See the instructions supplied with your wireless LAN access point/router for information on how to find the security settings. - The manufacturer's name or model number of the wireless LAN access point/router may be used as the default security settings. - Consult with the access point/router manufacturer, your Internet provider, or network administrator. | Wireless |
| Your Brother machine's MAC address is not allowed. | <p>Confirm that the Brother machine's MAC Address is allowed in the filter.</p> | Wireless |
| Your wireless LAN access point/router is in stealth mode (not broadcasting the SSID). | <ul style="list-style-type: none"> • Enter the correct SSID name or Network Key manually. • Check the SSID name or the Network Key in the instructions supplied with your wireless LAN access point/router and reconfigure the wireless network setup. | Wireless |



For Windows

If your wireless connection has been interrupted, and you have checked and tried all of the above, we recommend using the Network Connection Repair Tool.

My Brother Machine Cannot Print or Scan over the Network

If you can no longer print or scan via the network, press **WiFi Button/LED** and **Colour Start** simultaneously to restart the Wi-Fi.

| Cause | Action | Interface |
|---|---|-----------|
| Your security software blocks your machine's access to the network. (The Network scanning feature does not work.) | <ul style="list-style-type: none"> • Windows <p>Configure the third-party Security/Firewall Software to allow Network scanning. To add port 54925 for Network scanning, type the information below:</p> <ul style="list-style-type: none"> - In Name: Type any description, for example Brother NetScan. | Wireless |

| Cause | Action | Interface |
|---|---|-----------|
| | <ul style="list-style-type: none"> - In Port number: Type 54925. Type 137. Type 161. - In Protocol: UDP is selected. <p>See the instruction manual that came with your third-party Security/Firewall Software or contact the software manufacturer.</p> <ul style="list-style-type: none"> • Mac (Brother iPrint&Scan) In the Finder menu bar, click Go > Applications, and then double-click the Brother iPrint&Scan icon. The Brother iPrint&Scan window appears. Click the Select your Machine button, and then follow the on-screen instructions to reselect your network machine. | |
| Your security software blocks your machine's access to the network. | <p>Some security software might block access without showing a security alert dialog box even after successful installation.</p> <p>To allow access, see the instructions for your security software or ask the software manufacturer.</p> | Wireless |
| Your Brother machine was not assigned an available IP address. | <ul style="list-style-type: none"> • Confirm the IP address and the Subnet Mask. Verify that both the IP addresses and Subnet Masks of your computer and the Brother machine are correct and located on the same network. For more information about how to verify the IP address and the Subnet Mask, ask your network administrator. • Windows Confirm the IP address and the Subnet Mask using the Network Connection Repair Tool. • Mac Check your network devices using the ping command. For more information on how to confirm your network settings, see <i>Related Information: Check Network Devices Using the Ping Command</i>. | Wireless |
| The failed print job is still in your computer's print queue. (Windows) | <ul style="list-style-type: none"> • If the failed print job is still in your computer's print queue, delete it. • Otherwise, double-click the printer icon in the following folder and cancel all documents: <ul style="list-style-type: none"> - Windows 10, Windows Server 2016, and Windows Server 2019 Click  > Windows System > Control Panel. In the Hardware and Sound group, click View devices and printers. - Windows 8.1 Move your mouse to the lower right corner of your desktop. When the menu bar appears, click Settings > Control Panel. In the Hardware and Sound group, click View devices and printers. - Windows Server 2012 R2 Click Control Panel on the Start screen. In the Hardware group, click View devices and printers. - Windows Server 2012 Move your mouse to the lower right corner of your desktop. When the menu bar appears, click Settings > Control Panel. In the Hardware group, click View devices and printers > Printers. - Windows 7 and Windows Server 2008 R2 Click  (Start) > Devices and Printers. - Windows Server 2008 | Wireless |

| Cause | Action | Interface |
|--|--|-----------|
| | Click Start > Control Panel > Printers . | |
| Your Brother machine is not connected to the wireless network. | Print the WLAN Report to check the error code on the printed report. | Wireless |

If you have checked and tried all of the above, but your Brother machine still cannot print and scan, uninstall the drivers (Windows) and the Brother software and reinstall the latest version of both.

I Want to Check that My Network Devices are Working Correctly

| Check | Action | Interface |
|--|--|-----------|
| Check that your Brother machine, access point/router, or network hub is turned on. | <p>Check the following:</p> <ul style="list-style-type: none"> The power cord is connected correctly and the Brother machine is turned on. The access point/router or hub is turned on and its link indicator is blinking. All protective packaging has been removed from the machine. The document cover and Jam Clear Cover are fully closed. Paper is inserted correctly in the paper tray. | Wireless |
| Check that you can "ping" the Brother machine from your computer. | <p>Ping the Brother machine from your computer using the IP address or the node name in the Windows command prompt or Mac Terminal application:</p> <p>ping <ipaddress> or <nodename>.</p> <ul style="list-style-type: none"> Successful: Your Brother machine is working correctly and connected to the same network as your computer. Unsuccessful: Your Brother machine is not connected to the same network as your computer. <p>Windows: Ask your administrator about the IP address and the subnet mask, and then use the Network Connection Repair Tool.</p> <p>Mac: Confirm that the IP address and the Subnet Mask are set correctly.</p> | Wireless |
| Check that your Brother machine is connected to the wireless network. | Print the WLAN Report to check the error code on the printed report. | Wireless |

If you have checked and tried all of the above but you are still having problems, see the instructions supplied with your wireless LAN access point/router to find the SSID (Network Name) and the Network Key (Password) information and set them correctly.

Related Information

- [Network Problems](#)
 - [Check Network Devices Using the Ping Command](#)

Related Topics:

- [Print the WLAN Report](#)
- [Print the Network Configuration Report](#)
- [Use the Network Connection Repair Tool \(Windows\)](#)
- [Wireless LAN Report Error Codes](#)



Check Network Devices Using the Ping Command

Related Models: DCP-T420W/DCP-T425W/DCP-T426W

Check the IP addresses of both your computer and your Brother machine, and then confirm whether the network is operating correctly.

- >> [Configure the IP Address on your computer \(Windows\)](#)
- >> [Configure the IP Address on your computer \(Mac\)](#)
- >> [Configure the IP Address on your Brother machine](#)

Configure the IP Address on your computer (Windows)

1. Do one of the following:
 - Windows 10
Click  > **Windows System** > **Command Prompt**.
 - Windows 8.1
Move your mouse to the lower right corner of your desktop. When the menu bar appears, click **Search** > **Command Prompt**.
 - Windows7
Click  (**Start**) > **All Programs** > **Accessories** > **Command Prompt**.
2. Type "ipconfig" and then press the Enter key on your keyboard.
3. Confirm the values for the IPv4 address and subnet mask.
4. Type "exit" and then press the Enter key on your keyboard.

Configure the IP Address on your computer (Mac)

1. Select **System Preferences** from the Apple menu.
2. Click **Network** > **Advanced** > **TCP/IP**.
3. Confirm the values for the IPv4 address and subnet mask.

Configure the IP Address on your Brother machine

Print the Network Configuration Report, and confirm the values for the IP address and subnet mask.

```
<IP Settings >
IP Address          192.168.11.250      (set manually)
Subnet Mask         255.255.255.0
IP Gateway          192.168.100.200
Boot Method         STATIC
Boot Tries          3
IP Filter           Disabled
```

Check the IP addresses for both your computer and your Brother machine. Confirm that the network address portions are the same. For example, if the subnet mask is "255.255.255.0", it is normal for only the host address portions to be different.



| | Network Address | Host Address | |
|-------------|-----------------|--------------|---|
| IP Address | 192.168.100. | 250 | Set the final number, which corresponds to "0" in the subnet mask, to 1–254. |
| Subnet Mask | 255.255.255. | 0 | Usually, there are no problems when the subnet mask is "255.255.255.0". Use the same value for all of your computers. |



Related Information

- [If You Are Having Difficulty with Your Machine's Network](#)
-

Check the Machine Information

1. Start Brother iPrint&Scan.
 - Windows
Launch  (**Brother iPrint&Scan**).
 - Mac
In the **Finder** menu bar, click **Go > Applications**, and then double-click the iPrint&Scan icon.
The Brother iPrint&Scan screen appears.
2. If your Brother machine is not selected, click the **Select your Machine** button, and then select your model name from the list. Click **OK**.
3. Click  (**Machine Settings**) to configure the settings.
4. If required, type the password in the **Login** field, and then click **Login**.



The default password to manage this machine's settings is located on the back of the machine and marked "Pwd".

5. Go to the navigation menu, and then click **General > Maintenance Information**.



Start from , if the navigation menu is not shown on the left side of the screen.

6. Check your Brother machine's serial number, firmware version, and page counter.



You can also check your Brother machine's serial number and firmware version with the Print Quality Check Sheet.



Related Information

- [Troubleshooting](#)

Related Topics:

- [Check the Print Quality](#)
 - [Access Web Based Management](#)
-

Reset Your Machine

The following reset functions are available.

>> [Machine Reset](#)

>> [Network \(DCP-T420W/DCP-T425W/DCP-T426W\)](#)

>> [All Settings](#)

Machine Reset

You can reset all the machine's settings that you have changed, such as Date and Time.

1. Press  (**Stop**) and **Mono Start** simultaneously.

The **Power LED**, **Warning LED**, and **Ink LED** light up for one second, and then the **Warning LED** starts blinking.

2. Press and hold **Mono Start** for two seconds.
3. Wait until the machine restarts and the Power LED indicator lights up before disconnecting the machine from the power source.

Network (DCP-T420W/DCP-T425W/DCP-T426W)

Reset the print server back to its default factory settings (includes Password and IP Address information).

1. Press **WiFi Button/LED** and  (**Stop**) simultaneously.

The **Power LED**, **Warning LED**, and **Ink LED** light up for one second, and then the **WiFi Button/LED** starts blinking.

2. Press and hold **Colour Start** for two seconds.
3. Wait until the machine restarts and the Power LED indicator lights up before disconnecting the machine from the power source.

All Settings

Use this reset function to reset all machine's settings to the settings originally set at the factory.

Brother strongly recommends you perform this operation when you dispose of the machine.

1. Press  (**Stop**) and **Mono Start** simultaneously.

The **Power LED**, **Warning LED**, and **Ink LED** light up for one second, and then the **Warning LED** starts blinking.

2. Press and hold **Colour Start** for two seconds.
3. Wait until the machine restarts and the Power LED indicator lights up before disconnecting the machine from the power source.

Related Information

- [Troubleshooting](#)

Routine Maintenance

- [Refill the Ink Tanks](#)
- [Clean Your Brother Machine](#)
- [Check Your Brother Machine](#)
- [Check the Print Alignment from Your Brother Machine](#)
- [Check the Print Alignment Using Web Based Management](#)
- [Change the Print Options to Improve Your Print Results](#)
- [Pack and Ship Your Brother Machine](#)

Refill the Ink Tanks

Make sure to confirm the actual amount of remaining ink visually by looking through the window (1) of the ink tank. If the remaining ink level is at or below the lower line (2) under the minimum fill mark, refill the ink tank.

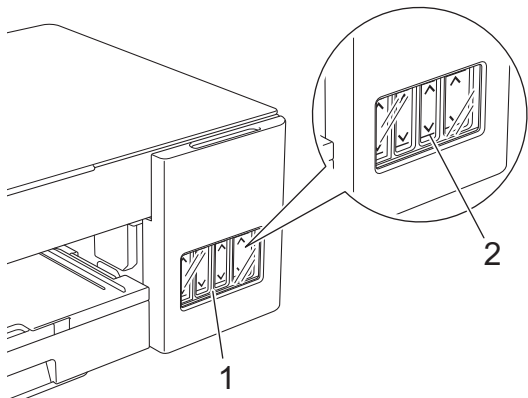

The ink below the lower line is necessary to prevent air from drying out and damaging the print head assembly. Refill the ink tank when the remaining ink level is at or below the lower line.

CAUTION

If ink gets into your eyes, rinse them with water immediately. If left as it is, it may cause red eye or mild inflammation. In case of any abnormality, consult your doctor.

IMPORTANT

- We recommend using genuine Brother supplies to ensure stable print quality and performance. Although not all non-genuine supplies may cause quality issues, it is possible that some may adversely affect print quality or cause machine malfunction. Brother may charge for repairing your machine if it is proven that non-genuine supplies caused the damage, even if the machine is still covered by the warranty.
- Check the ink bottle model name on the label. Using the incorrect ink may cause damage to the machine.

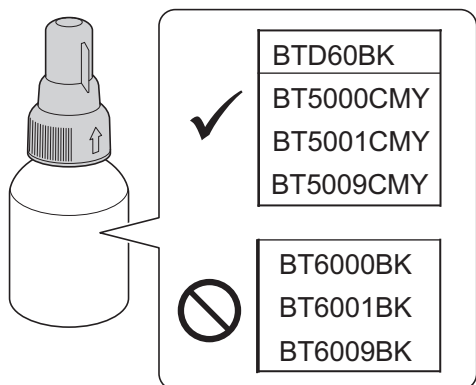

1. Open the ink tank cover (1).

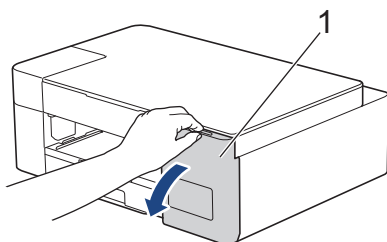

2. Remove the ink tank cap for the colour you want to refill, and place it on the back of the cover, as shown.

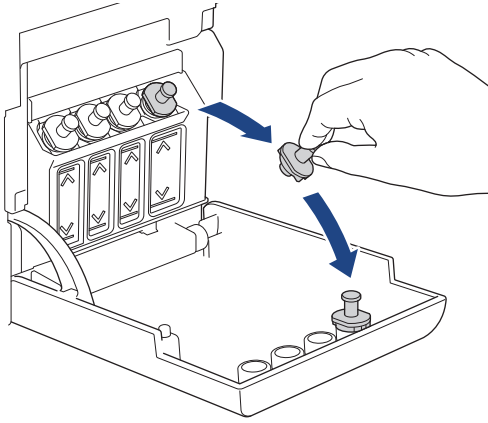

NOTE

Be careful to avoid touching any ink when handling the ink tank cap.

3. Remove the ink bottle cap, remove the film from the ink bottle, and then replace the cap.

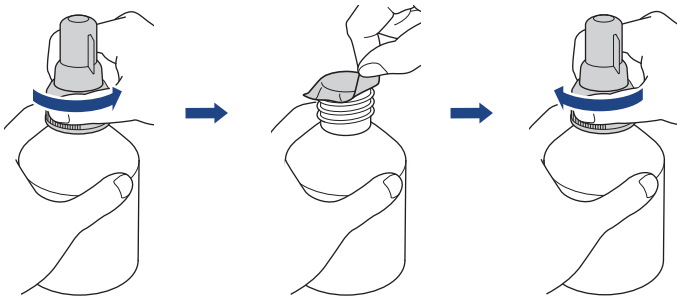

IMPORTANT

- Replace the ink bottle cap tightly. Otherwise, the ink may leak.
- DO NOT shake the ink bottles. If ink stains your skin or clothing, wash with soap or detergent at once.

4. Remove the nozzle cap, as shown.

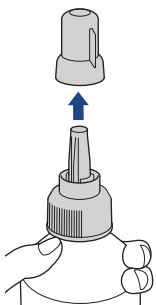

5. Make sure that the colour of the ink tank cap matches the ink colour you want to refill.

Keep the nozzle close to the ink tank opening and insert the bottle nozzle firmly into the ink tank so that the ink does not spill.

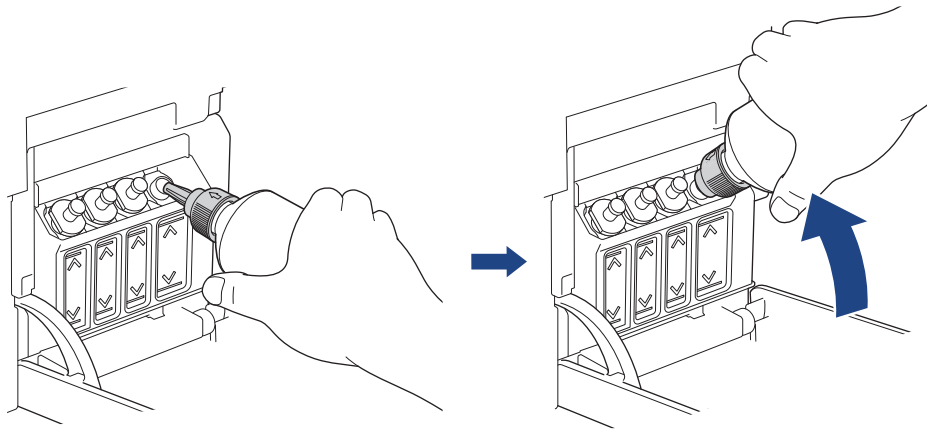

To fill the ink tank faster, insert the bottle nozzle firmly into the ink tank so that the arrow mark shown on the ink bottle in the illustration is up.

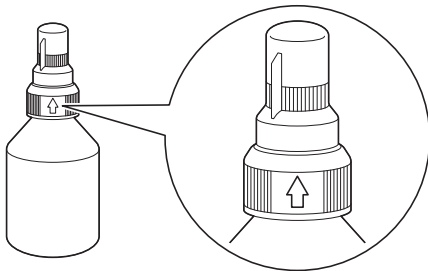

6. The bottle is self-standing, and the ink fills automatically until the bottle is empty or until the ink reaches the maximum fill mark line.

To fill the ink tank faster, squeeze the bottle on both sides.

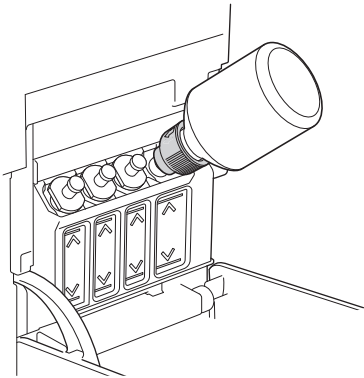

IMPORTANT

Be careful not to fill the ink past the upper line above the maximum fill mark.

NOTE

- Be careful not to spill any ink when you refill the ink tank.
- Refill with all of the ink in the bottle, if it does not exceed the upper line.

7. Keep the nozzle close to the ink tank opening and turn the nozzle up and remove the bottle from the ink tank so that the ink does not spill.

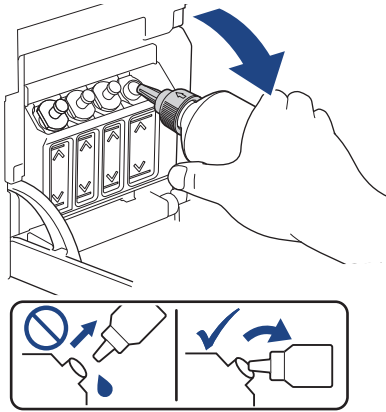

8. Replace the nozzle cap.

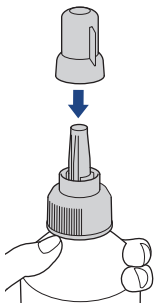

NOTE

- If any ink remains in the ink bottle, seal the cap tightly and store the ink bottle upright on a level surface in a cool, dark place.
- Avoid tilting the ink bottle or storing it on its side; it may leak.

9. Reattach the ink tank cap.

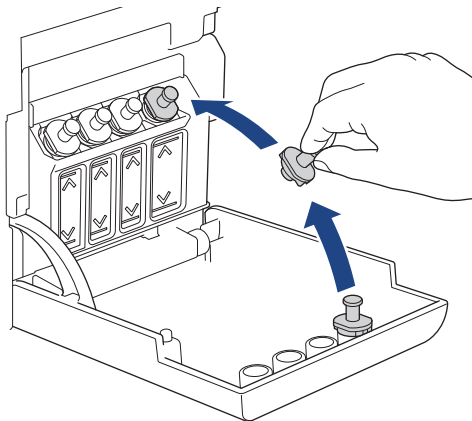

10. Repeat these steps for each ink tank you want to refill.

11. Close the ink tank cover.

If the **Ink LED** is blinking, press  (**Stop**).

IMPORTANT

- If you accidentally mix the colours by filling the wrong ink tank, contact Brother customer service or your local Brother dealer.

-
- If you have opened an ink bottle, use it within six months. Use unopened ink bottles by the expiration date written on the bottle package.
-



Related Information

- [Routine Maintenance](#)

Related Topics:

- [Error and Maintenance LED Indications](#)
 - [Paper Handling and Printing Problems](#)
-

Clean Your Brother Machine

- [Clean the Scanner](#)
- [Clean the Print Head from Your Brother Machine](#)
- [Clean the Print Head Using Web Based Management](#)
- [Clean the Print Head from Your Computer \(Windows\)](#)
- [Clean the Outside of the Machine](#)
- [Clean the Machine's Printer Platen](#)
- [Clean the Paper Feed Rollers](#)
- [Clean the Base Pad](#)
- [Clean the Paper Pick-up Rollers](#)

Clean the Scanner

1. Unplug the machine from the electrical socket.
2. Lift the document cover (1). Clean the scanner glass (2) and the white plastic (3) with a soft lint-free cloth moistened with water.

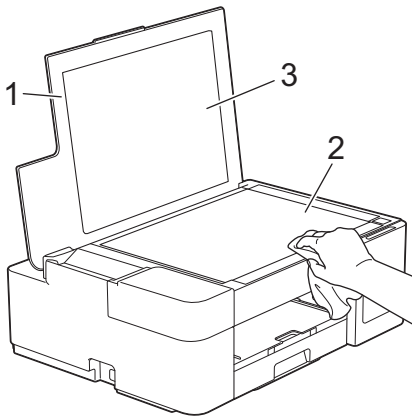

If you feel dirt or debris, clean the glass again. You may need to repeat the cleaning process three or four times. To test, make a copy after each cleaning attempt.



Related Information

- [Clean Your Brother Machine](#)

Related Topics:

- [Other Problems](#)

Clean the Print Head from Your Brother Machine

To maintain good print quality, the machine automatically cleans the print head when needed. If there is a print quality problem, start the cleaning process manually.

- Clean the print head if there is a horizontal line or a blank space in the text or graphics on printed pages. Depending on the problem colour, select to clean Black only or all four colours at once.
- Cleaning the print head consumes ink.
- Cleaning too often uses ink unnecessarily.

IMPORTANT

DO NOT touch the print head. Touching the print head may cause permanent damage and may void the print head's warranty.

1. Press  (**Stop**) and **Copy Shortcut** simultaneously.

The **Power LED**, **Warning LED**, and **Ink LED** light up for one second, and then the **Ink LED** starts blinking.

2. Do one of the following:
 - To clean all four colours, press **Colour Start**. After the cleaning, the machine prints the Print Quality Check Sheet.
 - To clean black only, press **Mono Start**. After the cleaning, the machine prints the Print Quality Check Sheet.

NOTE

If you clean the print head several times and the print has not improved, try the Special cleaning method, which cleans the print head with more force.

1. Make sure all ink tanks are filled more than halfway, as this method consumes a large amount of ink.
2. Press  (**Stop**) and **Copy Shortcut** simultaneously.
3. Press and hold **Mono Start** and **Colour Start** simultaneously, for five seconds.
The machine starts cleaning.



- Use the Special cleaning method only if you previously cleaned the print head several times and the print quality did not improve.
- If you start the cleaning with low ink amount, it may cause damage to the machine. Check each ink tank level before starting the cleaning and refill each ink tank as necessary.
- You can also clean the print head from your computer.



Related Information

- [Clean Your Brother Machine](#)

Related Topics:

- [Paper Handling and Printing Problems](#)
- [Clean the Print Head Using Web Based Management](#)
- [Clean the Print Head from Your Computer \(Windows\)](#)

Clean the Print Head Using Web Based Management

To maintain good print quality, the machine automatically cleans the print head when needed. If there is a print quality problem, start the cleaning process manually.

1. Start Brother iPrint&Scan.

- Windows

Launch  (**Brother iPrint&Scan**).

- Mac

In the **Finder** menu bar, click **Go > Applications**, and then double-click the iPrint&Scan icon.

The Brother iPrint&Scan screen appears.

2. If your Brother machine is not selected, click the **Select your Machine** button, and then select your model name from the list. Click **OK**.

3. Click  (**Machine Settings**) to configure the settings.

4. If required, type the password in the **Login** field, and then click **Login**.



The default password to manage this machine's settings is located on the back of the machine and marked "Pwd".

5. Go to the navigation menu, and then click **General > Print Head Cleaning**.



Start from , if the navigation menu is not shown on the left side of the screen.

6. Select the **Normal**, **Strong**, or **Strongest** option for the cleaning strength you want. The **Special** option uses the most power in cleaning the print heads, but also consumes the most ink.

7. Click **Start**.



-
- The **Special** option requires a large amount of ink to clean the print head. Refill all ink tank levels to more than half before starting the print head cleaning.
 - Use the **Special** option only if you previously used the **Strongest** option and the print quality did not improve.
 - If you start the cleaning with low ink amount, it may cause damage to the machine. Check each ink tank level before starting the cleaning and refill each ink tank as necessary.
-

8. Click **Yes**.

The machine starts cleaning.



(Windows) You can also clean the print head using the printer driver.



Related Information

- [Clean Your Brother Machine](#)

Related Topics:

- [Paper Handling and Printing Problems](#)
 - [Clean the Print Head from Your Brother Machine](#)
 - [Clean the Print Head from Your Computer \(Windows\)](#)
 - [Access Web Based Management](#)
-

Clean the Print Head from Your Computer (Windows)

To maintain good print quality, the machine automatically cleans the print head when needed. If there is a print quality problem, start the cleaning process manually.

1. Do one of the following:

- For Windows 10, Windows Server 2016, and Windows Server 2019

Click  > **Windows System** > **Control Panel**. In the **Hardware and Sound** group, click **View devices and printers**.

- For Windows 8.1

Move your mouse to the lower right corner of your desktop. When the menu bar appears, click **Settings**, and then click **Control Panel**. In the **Hardware and Sound** group, click **View devices and printers**.

- For Windows Server 2012 R2

Click **Control Panel** on the **Start** screen. In the **Hardware** group, click **View devices and printers**.

- For Windows Server 2012

Move your mouse to the lower right corner of your desktop. When the menu bar appears, click **Settings**, and then click **Control Panel**. In the **Hardware** group, click **View devices and printers**.

- For Windows 7 and Windows Server 2008 R2

Click  (**Start**) > **Devices and Printers**.

- For Windows Server 2008

Click  (**Start**) > **Control Panel** > **Hardware and Sound** > **Printers**.

2. Right-click the **Brother XXX-XXXX Printer** icon (where XXX-XXXX is the name of your model), and then select **Printing preferences**. If printer driver options appear, select your printer driver.

The printer driver dialog box appears.

3. Click the **Maintenance** tab.

4. Select one of the following options:

| Option | Description |
|-------------------------------|---|
| Check Print Quality... | Use to print the test page and check the print quality. |
| Print Head Cleaning... | Use to start the cleaning process manually. Select if a line or blank spaces appear in text or graphics on the test page. |

5. Do one of the following:

- If you selected the **Check Print Quality...** option, click **Start**.

The machine prints the test page.

- If you selected the **Print Head Cleaning...** option, select the **Black only**, **Colour only**, or **All** option for the cleaning type, and then click **Next**.

6. Select the **Normal**, **Strong**, or **Strongest** option for the cleaning strength, and then click **Next**.

7. Click **Start**.

The machine starts cleaning.



If you start the cleaning with low ink amount, it may cause damage to the machine. Check each ink tank level before starting the cleaning and refill each ink tank as necessary.



Related Information

- [Clean Your Brother Machine](#)

Related Topics:

- [Paper Handling and Printing Problems](#)
 - [Clean the Print Head from Your Brother Machine](#)
 - [Clean the Print Head Using Web Based Management](#)
-

Clean the Outside of the Machine

IMPORTANT

- Cleaning with volatile liquids such as thinner or benzine will damage the outside surface of the machine.
- DO NOT use cleaning materials that contain ammonia.
- DO NOT use isopropyl alcohol to remove dirt from the control panel. It may crack the panel.

1. If the paper support flap is open, close it, and then close the paper support.
2. Pull the paper tray (1) completely out of the machine.

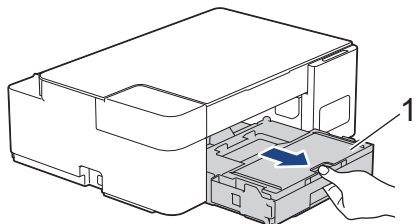

3. Wipe the outside of the machine with a dry, lint-free cloth to remove dust.

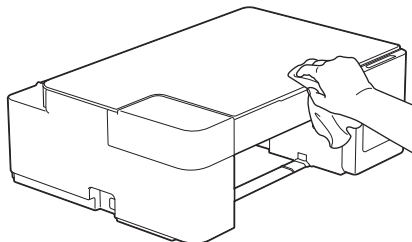

4. Lift the output paper tray cover and remove anything that is stuck inside the paper tray.

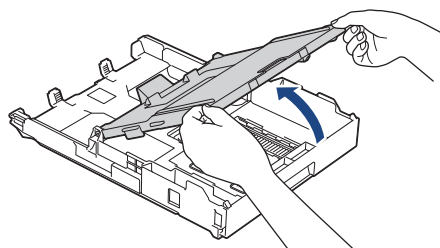

5. Wipe the inside and the outside of the paper tray with a dry, lint-free cloth to remove dust.

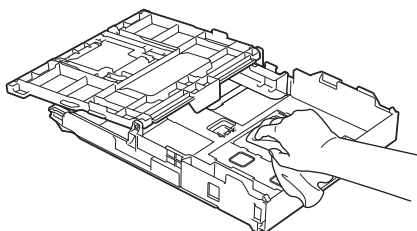

6. Close the output paper tray cover and slowly push the paper tray completely into the machine.



Related Information

- [Clean Your Brother Machine](#)

Clean the Machine's Printer Platen

WARNING

 Be sure to unplug the machine from the electrical socket before cleaning the printer platen to avoid an electrical shock.

1. Unplug the machine from the electrical socket.
2. If the paper support flap is open, close it, and then close the paper support.
3. Pull the paper tray (1) completely out of the machine.

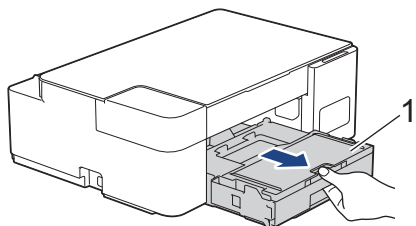

4. Clean the machine's printer platen (1) and the area around it, wiping off scattered ink with a dry, soft lint-free cloth.

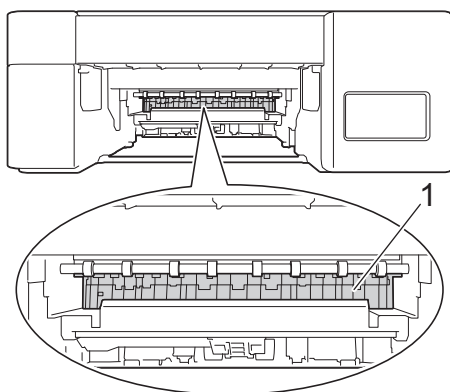

5. Slowly push the paper tray completely into the machine.
6. Reconnect the power cord.

Related Information

- [Clean Your Brother Machine](#)

Related Topics:

- [Paper Handling and Printing Problems](#)

Clean the Paper Feed Rollers

If the paper feed rollers are stained with ink or have a buildup of paper dust, it may cause paper feed problems.

WARNING

 Be sure to unplug the machine from the electrical socket before cleaning the paper feed rollers to avoid an electrical shock.

1. Unplug the machine from the electrical socket.
2. If the paper support flap is open, close it, and then close the paper support.
3. Pull the paper tray (1) completely out of the machine.

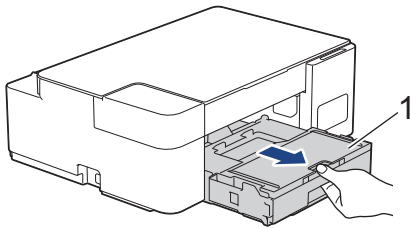

4. Clean the front and back sides of the Paper Feed Rollers (1) with a soft lint-free cloth moistened with water, using a side-to-side motion. After cleaning, wipe the rollers with a dry, soft lint-free cloth to remove all moisture.

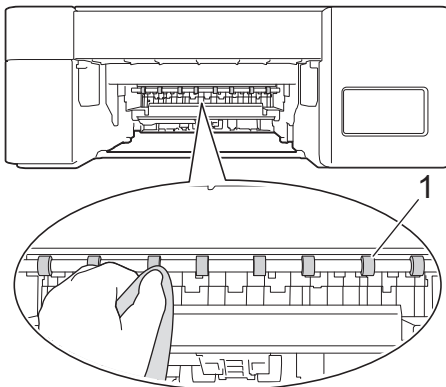

5. Slowly push the paper tray completely into the machine.
6. Reconnect the power cord.



Do not use the machine again until the rollers are dry. Using the machine before the rollers are dry may cause paper feed problems.



Related Information

- [Clean Your Brother Machine](#)

Related Topics:

- [Paper Handling and Printing Problems](#)

Clean the Base Pad

Cleaning the Base Pad periodically may prevent the machine from feeding multiple sheets of paper when there are only a few sheets of paper left in the tray.

1. If the paper support flap is open, close it, and then close the paper support.
2. Pull the paper tray (1) completely out of the machine.

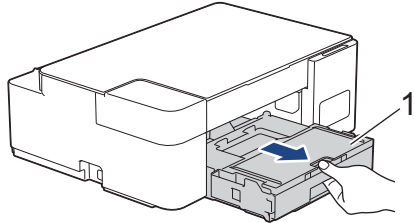

3. Clean the Base Pad (1) with a soft lint-free cloth moistened with water. After cleaning, wipe the pad with a dry, soft lint-free cloth to remove all moisture.

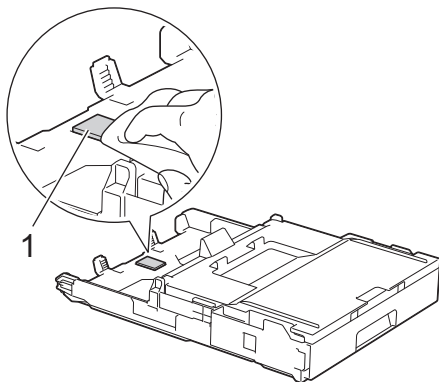

4. Slowly push the paper tray completely into the machine.

✓ Related Information

- [Clean Your Brother Machine](#)

Related Topics:

- [Paper Handling and Printing Problems](#)

Clean the Paper Pick-up Rollers

Cleaning the paper pick-up rollers periodically may prevent paper jams by ensuring that paper feeds correctly.

1. Unplug the machine from the electrical socket.
2. If the paper support flap (1) is open, close it, and then close the paper support (2).

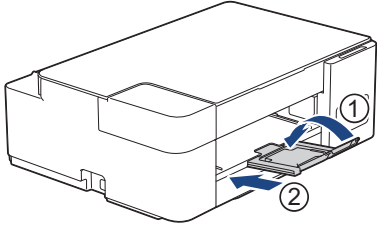

3. Pull the paper tray completely out of the machine.
4. Clean the Paper Pick-up Rollers (1) with a soft lint-free cloth moistened with water. Slowly turn the rollers so that the whole surface is cleaned. After cleaning, wipe the rollers with a dry, soft lint-free cloth to remove all moisture.

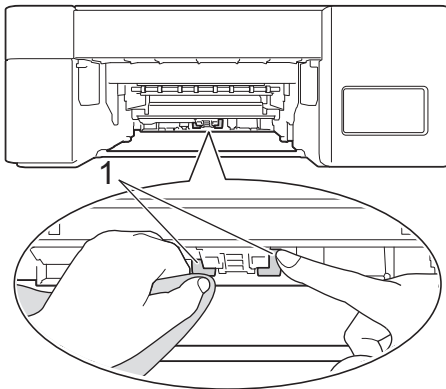

5. Slowly push the paper tray completely into the machine.
6. Reconnect the power cord.

✓ Related Information

- [Clean Your Brother Machine](#)

Related Topics:

- [Error and Maintenance LED Indications](#)
- [Paper Handling and Printing Problems](#)

Check Your Brother Machine

- [Check the Print Quality](#)
- [Monitor Machine Status from Your Computer \(Windows\)](#)
- [Monitor Machine Status Using Brother iPrint&Scan \(Windows/Mac\)](#)

Check the Print Quality

If faded or streaked colours and text appear or if text is missing on your printouts, the print head nozzles may be clogged. Print the Print Quality Check Sheet and look at the nozzle check pattern.

1. Press  (**Stop**) and **Copy Shortcut** simultaneously.

The **Power LED**, **Warning LED**, and **Ink LED** light up for one second, and then the **Ink LED** starts blinking.

2. Press **Copy Shortcut**.

The machine prints the Print Quality Check Sheet.

3. Check the quality of the four colour blocks on the sheet.

OK

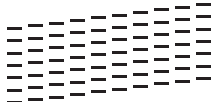

Poor

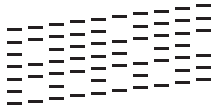

4. If the quality is poor, clean the print head. See *Related Information*.

IMPORTANT

DO NOT touch the print head. Touching the print head may cause permanent damage and may void the print head's warranty.



When a print head nozzle is clogged, the printed sample looks like this:



After the print head nozzle is cleaned, the horizontal lines are gone:



Related Information

- [Check Your Brother Machine](#)



Related Topics:

- [Paper Handling and Printing Problems](#)
- [Clean the Print Head from Your Brother Machine](#)

Monitor Machine Status from Your Computer (Windows)

The Status Monitor utility is a configurable software tool for monitoring the status of one or more machines; it allows you to get immediate notification of errors.

Do one of the following:

- Double-click the  icon in the task tray.
- Launch  (**Brother Utilities**), and then click the drop-down list and select your model name (if not already selected). Click **Tools** in the left navigation bar, and then click **Status Monitor**.

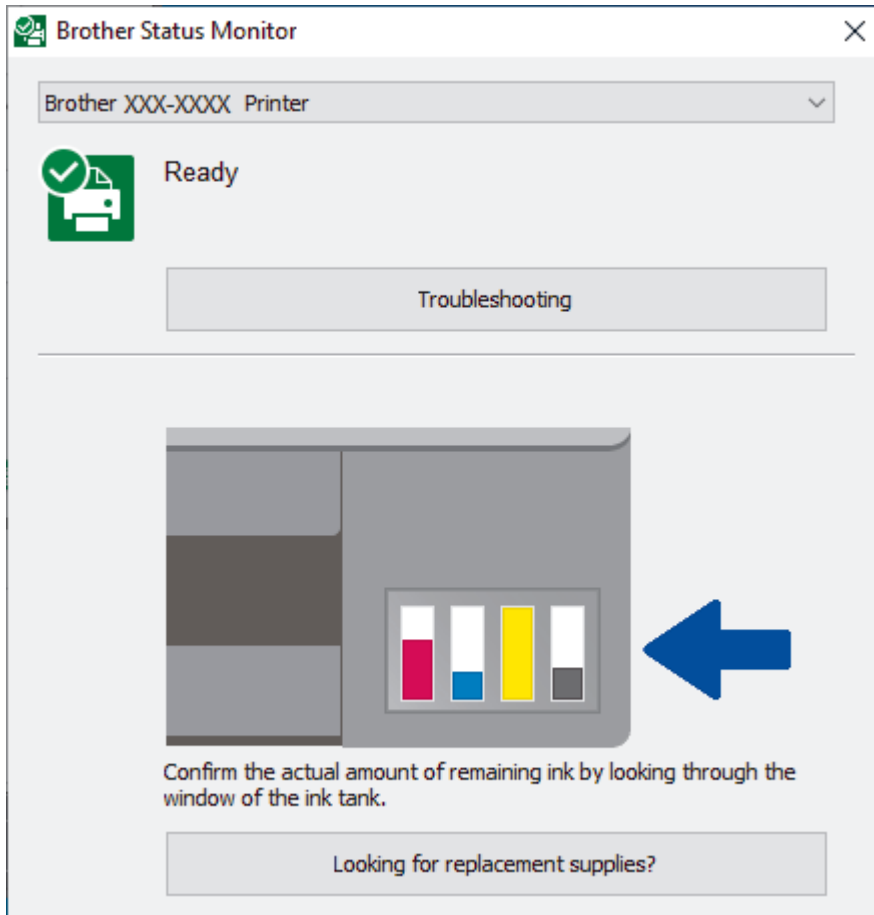

Troubleshooting

Click the **Troubleshooting** button to access the troubleshooting website.

Looking for replacement supplies?

Click the **Looking for replacement supplies?** button for more information on Brother original supplies.

Related Information

- [Check Your Brother Machine](#)
 - [Status Monitor Indicators and What They Mean \(Windows\)](#)
 - [Turn Off the Show Status Monitor Feature \(Windows\)](#)
 - [Turn Off the Status Monitor \(Windows\)](#)

Related Topics:

- [Cancel a Print Job \(Windows\)](#)

Status Monitor Indicators and What They Mean (Windows)

When you start up your computer, the **Brother Status Monitor** icon appears on the task tray.

- A green icon indicates the normal stand-by condition.



- A yellow icon indicates a warning.



- A red icon indicates an error has occurred.



- A grey icon indicates the machine is offline.



Related Information

- [Monitor Machine Status from Your Computer \(Windows\)](#)

Turn Off the Show Status Monitor Feature (Windows)

The Show Status Monitor feature lets you know if there is a problem with a device that your computer is monitoring. The default setting is **Only when printing from this PC**. To turn it off, follow these steps:

1. Right-click the  (**Brother Status Monitor**) icon or window, select the **Status Monitor Settings** option, and then click **Options**.

The **Options** window appears.

2. Click the **Basic** tab, and then select **Off** for **Show Status Monitor**.
3. Click **OK**.



Even if the Show Status Monitor feature is turned off, you can check the machine's status at any time by displaying the Status Monitor.



Related Information

- [Monitor Machine Status from Your Computer \(Windows\)](#)

Turn Off the Status Monitor (Windows)

1. Right-click the  (**Brother Status Monitor**) icon or window, and then select **Exit**.
2. Click **OK**.



Related Information

- [Monitor Machine Status from Your Computer \(Windows\)](#)
-

Monitor Machine Status Using Brother iPrint&Scan (Windows/Mac)

Brother iPrint&Scan allows you to monitor your Brother machine's status.

1. Start Brother iPrint&Scan.

- Windows

Launch  (Brother iPrint&Scan).

- Mac



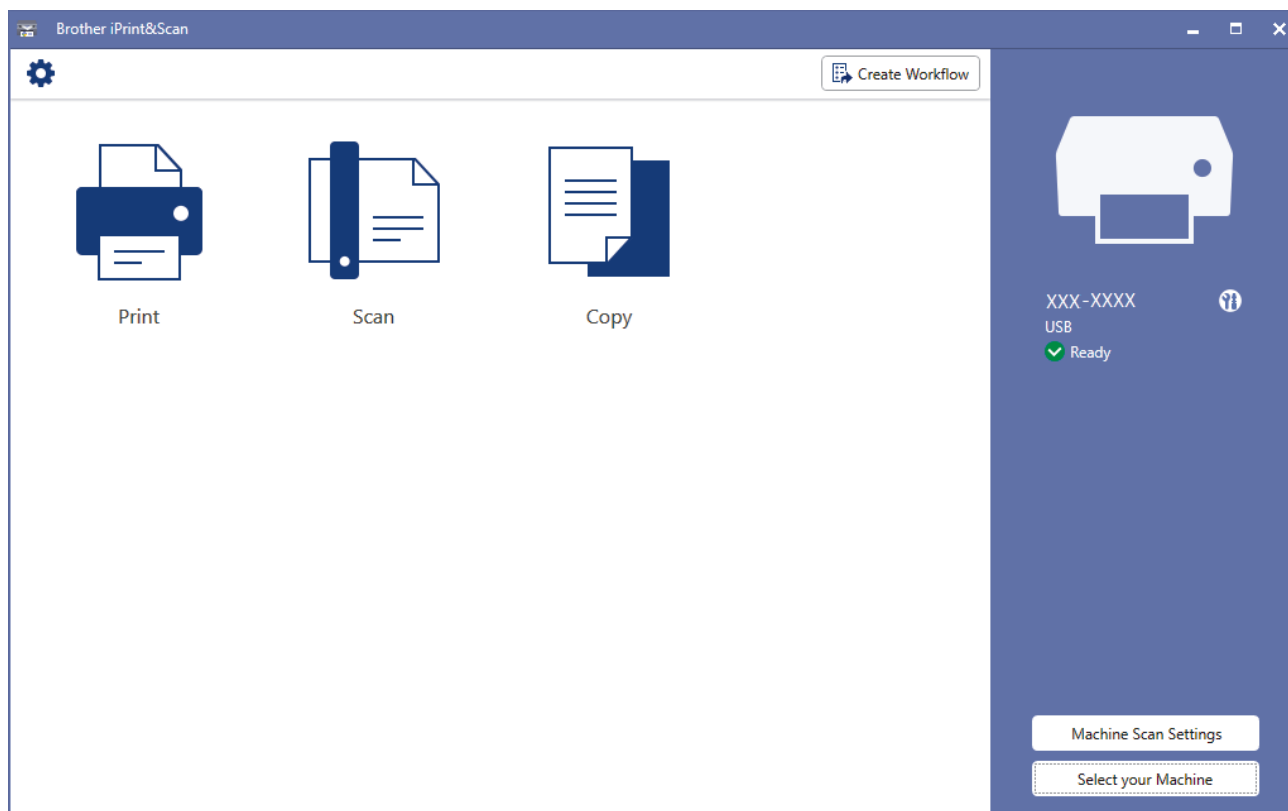

In the **Finder** menu bar, click **Go > Applications**, and then double-click the iPrint&Scan icon.

The Brother iPrint&Scan screen appears.

2. If your Brother machine is not selected, click the **Select your Machine** button, and then select your model name from the list. Click **OK**.



Status icons

| Icon | Description |
|---|---|
|  | A green icon indicates the normal stand-by condition. |
|  | A yellow icon indicates a warning. |
|  | A red icon indicates an error has occurred. |
|  | A grey icon indicates the machine is offline. |



The actual screen may differ depending on the version of the application.



Related Information

- [Check Your Brother Machine](#)
-

Check the Print Alignment from Your Brother Machine

After transporting the machine, adjust the print alignment if the text is blurred or images become faded, and adjust the paper feed to reduce dark lines.

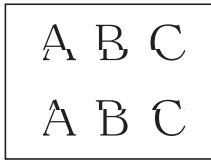
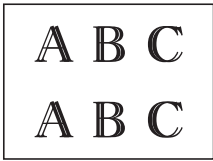

Before starting to check the print alignment, check the print quality. See *Related Information*.

1. Turn the machine off.
2. Press and hold **Mono Start** and turn the machine on, then hold **Mono Start** until the Adjustment Sheet is printed.

The **Power LED** blinks, and then the machine prints the Adjustment Sheet.

3. When the **Power LED** blinks slowly, place the Adjustment Sheet on the scanner glass so that the black square mark on the Adjustment Sheet is in the lower right corner.

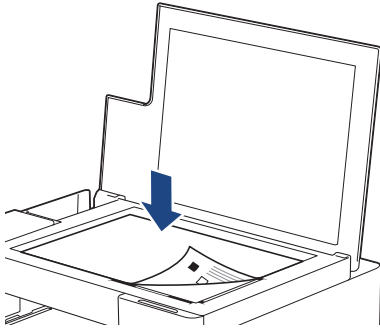

4. Press **Mono Start** or **Colour Start**.

The **Power LED** blinks while the machine starts scanning and performs automatic adjustment.



Immediately after scanning is finished, the LED indicates the adjustment results:

- When adjustment is OK:

The **Power LED** blinks quickly three times, and the machine returns to the standby condition.

- When there is an adjustment error:

The **Warning LED** and **Ink LED** blink quickly three times, and the machine returns to the standby condition.

You need to try this adjustment one more time from the beginning.

5. If the print quality has not improved, try the print adjustment again.



You can also check the print alignment from your computer.



Related Information

- [Routine Maintenance](#)



Related Topics:

- [Check the Print Alignment Using Web Based Management](#)
- [Check the Print Quality](#)

Check the Print Alignment Using Web Based Management

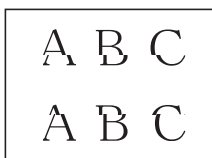
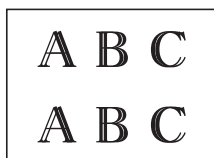

After transporting the machine, adjust the print alignment if the text is blurred or images become faded, and adjust the paper feed to reduce dark lines.



1. Start Brother iPrint&Scan.
 - Windows
Launch  (**Brother iPrint&Scan**).
 - Mac
In the **Finder** menu bar, click **Go > Applications**, and then double-click the iPrint&Scan icon.
The Brother iPrint&Scan screen appears.
2. If your Brother machine is not selected, click the **Select your Machine** button, and then select your model name from the list. Click **OK**.
3. Click  (**Machine Settings**) to configure the settings.
4. If required, type the password in the **Login** field, and then click **Login**.

 The default password to manage this machine's settings is located on the back of the machine and marked "Pwd".

5. Go to the navigation menu, and then click **General > Alignment**.

 Start from , if the navigation menu is not shown on the left side of the screen.

6. Follow the on-screen instructions.

Related Information

- [Routine Maintenance](#)

Related Topics:

- [Access Web Based Management](#)

Change the Print Options to Improve Your Print Results

If your printouts do not look the way you expect, change the print settings on your Brother machine to improve printout quality. Print speed may be slower when using these settings.



- These instructions allow you to improve your print results when you are using your machine for copying or printing from a mobile device.
- If you are experiencing poor print quality when printing from your computer, change your printer driver settings.

1. Start Brother iPrint&Scan.

- Windows

Launch  (**Brother iPrint&Scan**).

- Mac

In the **Finder** menu bar, click **Go > Applications**, and then double-click the iPrint&Scan icon.

The Brother iPrint&Scan screen appears.

2. If your Brother machine is not selected, click the **Select your Machine** button, and then select your model name from the list. Click **OK**.

3. Click  (**Machine Settings**) to configure the settings.

4. If required, type the password in the **Login** field, and then click **Login**.



The default password to manage this machine's settings is located on the back of the machine and marked "Pwd".

5. Go to the navigation menu, and then click **General > Print Options**.



Start from , if the navigation menu is not shown on the left side of the screen.

6. Configure the **Reduce Smudging** settings if you have problems with smudged printouts or paper jams.

7. Select **On** for **Enhance Print** if you have problems with blurred printouts.

8. Click **Submit**.



Related Information

- [Routine Maintenance](#)

Related Topics:

- [Paper Handling and Printing Problems](#)
- [Other Problems](#)
- [Prevent Smudged Printouts and Paper Jams \(Windows\)](#)
- [Print Settings \(Windows\)](#)
- [Access Web Based Management](#)

Pack and Ship Your Brother Machine

- When you transport the machine, use the packing materials that came with your machine. Do not tip or turn the product upside down. If you do not pack the machine correctly, any damage that may occur in transit may not be covered by your warranty.
- The machine should be adequately insured with the carrier.

IMPORTANT

It is important to allow the machine to “park” the print head after a print job. Listen carefully to the machine before unplugging it to make sure that all mechanical noises have stopped. Not allowing the machine to finish this parking process may lead to print problems and possible damage to the print head.

1. Unplug the machine from the electrical socket.
2. Lift the document cover.
3. Unplug the interface cable from the machine, if it is connected.
4. Close the document cover.

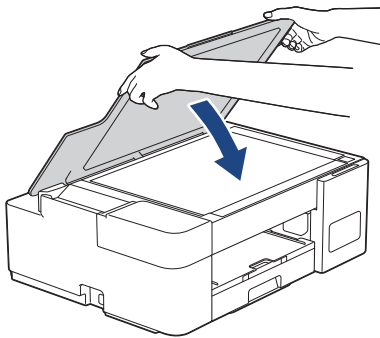

5. Open the ink tank cover.
6. Make sure the ink tank caps are installed correctly.
Push down on the ink tank caps to secure them tightly and then close the ink tank cover.

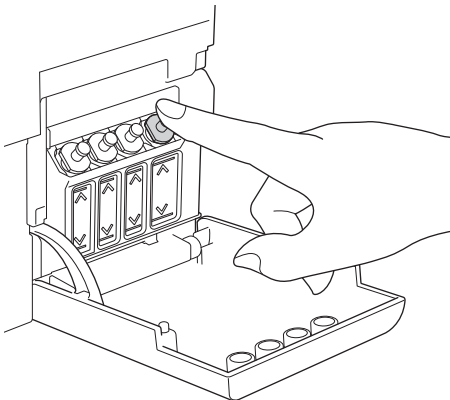

7. Wrap the machine in the bag.

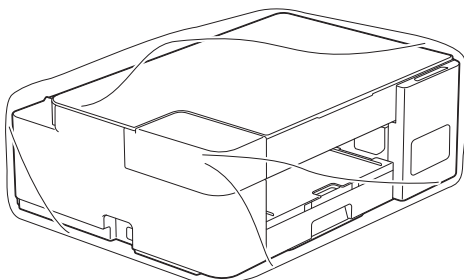

8. Pack the machine in the original carton with the original packing material as shown below.
Do not pack the used ink bottles in the carton.

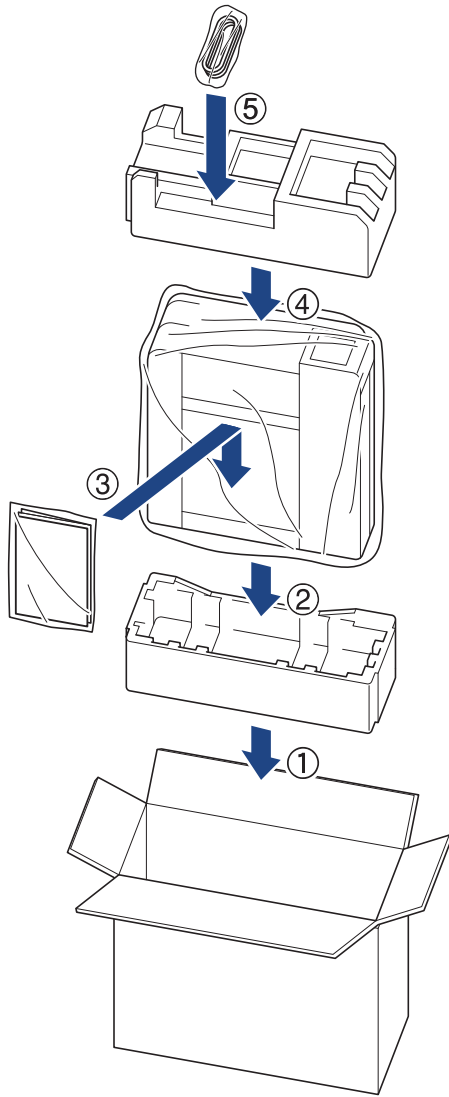

9. Close the carton and tape it shut.



Related Information

- [Routine Maintenance](#)

Machine Settings

Customise settings and features to make your machine a more efficient work tool.

- [Change Machine Settings Using Web Based Management](#)
- [In the Event of Power Failure \(Memory Storage\)](#)

Change Machine Settings Using Web Based Management

Web Based Management is a utility that uses a standard web browser to manage your machine using the Hyper Text Transfer Protocol (HTTP) or Hyper Text Transfer Protocol over Secure Socket Layer (HTTPS).

- [What is Web Based Management?](#)
- [Access Web Based Management](#)
- [Set or Change a Login Password for Web Based Management](#)
- [General Settings](#)

What is Web Based Management?

Web Based Management is a utility that uses a standard web browser to manage your machine using the Hyper Text Transfer Protocol (HTTP) or Hyper Text Transfer Protocol over Secure Socket Layer (HTTPS).



- We recommend Microsoft Internet Explorer 11/Microsoft Edge for Windows, Safari 10/11 for Mac, Chrome for Android (4.x or later), and Chrome/Safari for iOS (10.x or later). Make sure that JavaScript and Cookies are always enabled in whichever browser you use.
- (DCP-T420W/DCP-T425W/DCP-T426W) You must use the TCP/IP protocol on your network and have a valid IP address programmed into the print server and your computer.

XXX-XXXX

brother

The screenshot displays the Brother web-based management interface. On the left is a dark sidebar with a 'Logout' button and a warning about the default password. Below this is a menu with 'Home', 'Status', 'Auto Refresh Interval', 'General', 'Copy', 'Print', 'Scan', 'Administrator', 'Online Functions', and 'Network'. The 'Status' page is active, showing 'Status' as 'Ready' with a green bar. Below that, 'Device Status' is also 'Ready'. The 'Automatic Refresh' option is set to 'Off'. The 'Web Language' is set to 'Auto'. The 'Device Location' section has empty 'Contact' and 'Location' fields.

The actual screen may differ from the screen shown above.



Related Information

- [Change Machine Settings Using Web Based Management](#)

Access Web Based Management

- We recommend Microsoft Internet Explorer 11/Microsoft Edge for Windows, Safari 10/11 for Mac, Chrome for Android (4.x or later), and Chrome/Safari for iOS (10.x or later). Make sure that JavaScript and Cookies are always enabled in whichever browser you use.
- The default password to manage this machine's settings is located on the back of the machine and marked "**Pwd**". We recommend immediately changing the default password to protect your machine from unauthorised access. (DCP-T420W/DCP-T425W/DCP-T426W) You can also find the default password in the Network Configuration Report.
- (DCP-T420W/DCP-T425W/DCP-T426W)
We recommend using the HTTPS security protocol when configuring settings using Web Based Management.
- (DCP-T420W/DCP-T425W/DCP-T426W)
When you use HTTPS for Web Based Management configuration, your browser will display a warning dialog box. To avoid displaying the warning dialog box, you can install a self-signed certificate to use SSL/TLS communication. For more detailed information, see *Related Information*.

>> [Start from Brother iPrint&Scan \(Windows/Mac\)](#)

>> [Start from Your Web Browser \(DCP-T420W/DCP-T425W/DCP-T426W\)](#)

>> [Start from Brother Utilities \(Windows\)](#)

Start from Brother iPrint&Scan (Windows/Mac)

1. Start Brother iPrint&Scan.

- Windows

Launch  (**Brother iPrint&Scan**).

- Mac

In the **Finder** menu bar, click **Go > Applications**, and then double-click the iPrint&Scan icon.



The Brother iPrint&Scan screen appears.

2. If your Brother machine is not selected, click the **Select your Machine** button, and then select your model name from the list. Click **OK**.

3. Click  (**Machine Settings**).

Web Based Management appears.

4. If required, type the password in the **Login** field, and then click **Login**.

5. If you want to pin the navigation menu on the left side of the screen, click  and then click .

You can now change the machine settings.



You can also access Web Based Management from Brother iPrint&Scan for mobile devices.

Start from Your Web Browser (DCP-T420W/DCP-T425W/DCP-T426W)

1. Start your web browser.

2. Type "https://machine's IP address" in your browser's address bar (where "machine's IP address" is the machine's IP address).

For example:

https://192.168.1.2



If you are using a Domain Name System or enable a NetBIOS name, you can type another name, such as "SharedPrinter" instead of the IP address.

For example:

https://SharedPrinter

If you enable a NetBIOS name, you can also use the node name.

For example:

https://brnxxxxxxxxxxxx

The NetBIOS name can be found in the Network Configuration Report.

3. If required, type the password in the **Login** field, and then click **Login**.
4. If you want to pin the navigation menu on the left side of the screen, click ☰ and then click ✖.

You can now change the machine settings.

Start from Brother Utilities (Windows)

1. Launch  (**Brother Utilities**), and then click the drop-down list and select your model name (if not already selected).
2. Click **Tools** in the left navigation bar, and then click **Machine Settings**.
Web Based Management appears.
3. If required, type the password in the **Login** field, and then click **Login**.
4. If you want to pin the navigation menu on the left side of the screen, click ☰ and then click ✖.

You can now change the machine settings.

(DCP-T420W/DCP-T425W/DCP-T426W)

If you change the protocol settings, you must restart the machine after clicking **Submit** to activate the configuration.

After configuring the settings, click **Logout**.



Related Information



- [Change Machine Settings Using Web Based Management](#)

Related Topics:

- [Print the Network Configuration Report](#)
- [Create a Self-signed Certificate](#)
- [Install the Self-signed Certificate for Windows users with Administrator Rights](#)

Set or Change a Login Password for Web Based Management

The default password to manage this machine's settings is located on the back of the machine and marked "Pwd". We recommend immediately changing the default password to protect your machine from unauthorised access.

1. Start Brother iPrint&Scan.
 - Windows
Launch  (Brother iPrint&Scan).
 - Mac
In the **Finder** menu bar, click **Go > Applications**, and then double-click the iPrint&Scan icon.
The Brother iPrint&Scan screen appears.
2. If your Brother machine is not selected, click the **Select your Machine** button, and then select your model name from the list. Click **OK**.
3. Click  (**Machine Settings**) to configure the settings.
4. Do one of the following:
 - If you have previously set your own password, type it, and then click **Login**.
 - If you have not previously set your own password, type the default login password, and then click **Login**.
5. Go to the navigation menu, and then click **Administrator > Login Password**.



Start from , if the navigation menu is not shown on the left side of the screen.

6. Following the on-screen guidelines, type your password in the **Enter New Password** field.
7. Retype the password in the **Confirm New Password** field.
8. Click **Submit**.



Related Information



- [Change Machine Settings Using Web Based Management](#)

General Settings

- [Set Sleep Mode Countdown](#)
- [Set the Machine to Power Off Automatically](#)
- [Set the Date and Time](#)
- [Reduce Printing Noise](#)
- [Change the Language Printed in the Reports and Sheets](#)

Set Sleep Mode Countdown

The Sleep Mode (or Power Save Mode) setting can reduce power consumption. When the machine is in Sleep Mode, it acts as if it is turned off. The machine will wake up and start printing when it receives a print job. Use these instructions to set a time delay (countdown) before the machine enters Sleep Mode.

- The timer will restart if any operation is carried out on the machine, such as receiving a print job.
 - The factory setting is five minutes.
1. Start Brother iPrint&Scan.
 - Windows
Launch  (Brother iPrint&Scan).
 - Mac
In the **Finder** menu bar, click **Go > Applications**, and then double-click the iPrint&Scan icon.
The Brother iPrint&Scan screen appears.
 2. If your Brother machine is not selected, click the **Select your Machine** button, and then select your model name from the list. Click **OK**.
 3. Click  (**Machine Settings**) to configure the settings.
 4. If required, type the password in the **Login** field, and then click **Login**.



The default password to manage this machine's settings is located on the back of the machine and marked "Pwd".

5. Go to the navigation menu, and then click **General > Sleep Time**.



Start from , if the navigation menu is not shown on the left side of the screen.

6. Enter the **Sleep Time** field (1-60).
7. Click **Submit**.



Related Information

- [General Settings](#)

Related Topics:

- [Set the Machine to Power Off Automatically](#)
 - [Access Web Based Management](#)
-

Set the Machine to Power Off Automatically

The Auto Power Off feature can reduce power consumption. Set the amount of time that the machine must be in Sleep Mode before it automatically powers off. When this feature is set to off, you must power off the machine manually.

To turn on the machine after the Auto Power Off feature has turned it Off, press  (**Stop**).



(DCP-T420W/DCP-T425W/DCP-T426W)

The machine does not power off automatically when:

- The machine is connected to a wireless network.
- Wi-Fi is set to On.

1. Start Brother iPrint&Scan.

- Windows

Launch  (**Brother iPrint&Scan**).

- Mac

In the **Finder** menu bar, click **Go > Applications**, and then double-click the iPrint&Scan icon.

The Brother iPrint&Scan screen appears.

2. If your Brother machine is not selected, click the **Select your Machine** button, and then select your model name from the list. Click **OK**.

3. Click  (**Machine Settings**) to configure the settings.

4. If required, type the password in the **Login** field, and then click **Login**.



The default password to manage this machine's settings is located on the back of the machine and marked "Pwd".

5. Go to the navigation menu, and then click **General > Auto Power Off**.



Start from , if the navigation menu is not shown on the left side of the screen.

6. Click the **Auto Power Off** drop-down list, and then select the option you want.

7. Click **Submit**.



Related Information



- [General Settings](#)

Related Topics:

- [Set Sleep Mode Countdown](#)
- [Access Web Based Management](#)



Set the Date and Time

Make sure the date and time setting is set correctly using Web Based Management, so the machine's time matches the time being used by the server providing authentication.

1. Start Brother iPrint&Scan.
 - Windows
Launch  (**Brother iPrint&Scan**).
 - Mac
In the **Finder** menu bar, click **Go > Applications**, and then double-click the iPrint&Scan icon.
The Brother iPrint&Scan screen appears.
2. If your Brother machine is not selected, click the **Select your Machine** button, and then select your model name from the list. Click **OK**.
3. Click  (**Machine Settings**) to configure the settings.
4. If required, type the password in the **Login** field, and then click **Login**.

 The default password to manage this machine's settings is located on the back of the machine and marked "Pwd".

5. Go to the navigation menu, and then click **Administrator > Date&Time**.

 Start from , if the navigation menu is not shown on the left side of the screen.

6. In the **Date** fields, enter the date.
7. In the **Time** fields, enter the time.
8. Click **Submit**.

Related Information

- [General Settings](#)

Related Topics:

- [Access Web Based Management](#)

Reduce Printing Noise

The Quiet Mode setting can reduce printing noise. When Quiet Mode is turned on, the print speed becomes slower.

The factory setting is Off.

1. Start Brother iPrint&Scan.

- Windows

Launch  (Brother iPrint&Scan).

- Mac

In the **Finder** menu bar, click **Go > Applications**, and then double-click the iPrint&Scan icon.

The Brother iPrint&Scan screen appears.

2. If your Brother machine is not selected, click the **Select your Machine** button, and then select your model name from the list. Click **OK**.
3. Click  (**Machine Settings**) to configure the settings.
4. If required, type the password in the **Login** field, and then click **Login**.



The default password to manage this machine's settings is located on the back of the machine and marked "Pwd".

5. Go to the navigation menu, and then click **Print > Print**.



Start from , if the navigation menu is not shown on the left side of the screen.

6. Select **On** (or **Off**) in the **Quiet Mode** option.
7. Click **Submit**.



Related Information

- [General Settings](#)



Related Topics:

- [Paper Handling and Printing Problems](#)
 - [Access Web Based Management](#)
-

Change the Language Printed in the Reports and Sheets



Change the language printed in the reports and sheets if needed.

This feature is not available for some countries.

1. Start Brother iPrint&Scan.
 - Windows
Launch  (Brother iPrint&Scan).
 - Mac
In the **Finder** menu bar, click **Go > Applications**, and then double-click the iPrint&Scan icon.
The Brother iPrint&Scan screen appears.
2. If your Brother machine is not selected, click the **Select your Machine** button, and then select your model name from the list. Click **OK**.
3. Click  (**Machine Settings**) to configure the settings.
4. If required, type the password in the **Login** field, and then click **Login**.

 The default password to manage this machine's settings is located on the back of the machine and marked "Pwd".

5. Go to the navigation menu, and then click **General > Local Language**.

 Start from , if the navigation menu is not shown on the left side of the screen.

6. Select your language from the **Local Language** drop-down list.
7. Click **Submit**.

Related Information

- [General Settings](#)

Related Topics:

- [Access Web Based Management](#)

In the Event of Power Failure (Memory Storage)

- Your menu settings are stored permanently and will not be lost.
- Temporary settings are lost.
- The date and time must be re-entered.



Related Information

- [Machine Settings](#)
-

Appendix

- [Specifications](#)
- [Supply Specifications](#)
- [Information Regarding Recycled Paper](#)
- [Brother Help and Customer Support](#)

Specifications

- >> General Specifications
- >> Document Size Specifications
- >> Print Media Specifications
- >> Copy Specifications
- >> Scanner Specifications
- >> Printer Specifications
- >> Interface Specifications
- >> Network Specifications
- >> Computer Requirements Specifications

General Specifications

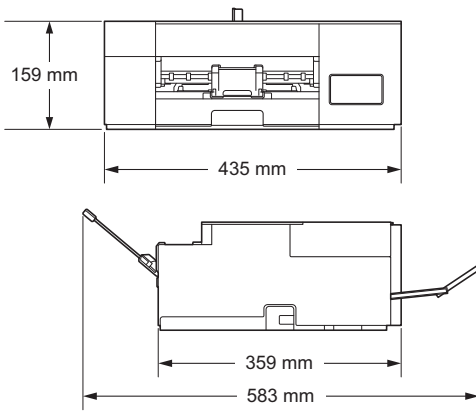
| | | |
|---------------------------------------|-----------------------|---|
| Printer Type | | Inkjet |
| Print Head | Mono | Piezo with 210 nozzles x 1 |
| | Colour | DCP-T220/DCP-T225/DCP-T226/DCP-T420W/DCP-T425W/ DCP-T426W Piezo with 70 nozzles x 3 |
| Memory Capacity | | 64 MB |
| Power Source | | AC 220 to 240 V 50/60 Hz |
| Power Consumption ¹ | | <ul style="list-style-type: none"> • DCP-T220/DCP-T225/DCP-T226 Copying²: Approx. 11 W Ready³: Approx. 2.5 W Sleep³: Approx. 0.7 W Power Off^{3 4}: Approx. 0.2 W • DCP-T420W/DCP-T425W/DCP-T426W Copying²: Approx. 11 W Ready³: Approx. 2.5 W Sleep³: Approx. 0.7 W Power Off^{3 4}: Approx. 0.2 W |
| Dimensions | | <p>DCP-T220/DCP-T225/DCP-T226/DCP-T420W/DCP-T425W/ DCP-T426W</p>  |
| Weights | | <ul style="list-style-type: none"> • DCP-T220/DCP-T225/DCP-T226 6.4 kg • DCP-T420W/DCP-T425W/DCP-T426W 6.4 kg |
| Noise Level | Sound Pressure | Operating 53.5 dB (A) (Approx.) ⁵ |

| | | |
|--------------------|---------------------------|----------------------------------|
| Temperature | Operating | 10 to 35°C |
| | Best Print Quality | 20 to 33°C |
| Humidity | Operating | 20 to 80% (without condensation) |
| | Best Print Quality | 20 to 80% (without condensation) |

- 1 Measured when the machine is connected to the USB interface. Power consumption varies slightly depending on the usage environment or part wear.
- 2 When single-sided printing, resolution: standard / document: ISO/IEC 24712 printed pattern.
- 3 Measured according to IEC 62301 Edition 2.0.
- 4 Even when the machine is turned off, it will automatically turn itself on periodically for print head maintenance, and then turn itself off.
- 5 Noise depends on printing conditions.

Document Size Specifications

| | | |
|----------------------|-----------------------------|---------------|
| Document Size | Scanner Glass Width | Max. 215.9 mm |
| | Scanner Glass Length | Max. 297 mm |

Print Media Specifications

| | | | |
|----------------------------------|-------------------------|--|---|
| Paper Input | Paper Tray | Paper Type ¹ | Plain Paper, Inkjet Paper (coated paper), Glossy Paper, Recycled Paper |
| | | Paper Size | A4, Letter, Executive, A5, A6, Envelopes (C5, Com-10, DL, Monarch), Photo (4" x 6")/(10 x 15 cm), Photo 2L (5" x 7")/(13 x 18 cm), Index card (5" x 8")/(13 x 20 cm) |
| | | Maximum Paper Capacity | Up to 150 sheets of 80 g/m ² plain paper |
| | Manual Feed Slot | Paper Type ¹ | Plain Paper, Inkjet Paper (coated paper), Glossy Paper, Recycled Paper |
| | | Paper Size | A4, Letter, Executive, A5, A6, Envelopes (C5, Com-10, DL, Monarch), Photo (4" x 6")/(10 x 15 cm), Photo L (3.5" x 5")/(9 x 13 cm), Photo 2L (5" x 7")/(13 x 18 cm), Index card (5" x 8")/(13 x 20 cm) |
| | | Maximum Paper Capacity | Up to 1 sheet |
| Paper Output ¹ | | Up to 50 sheets of 80 g/m ² Plain Paper (face up print delivery to the output paper tray) | |

- 1 For glossy paper, remove any printed pages from the output paper tray immediately to avoid smudging.

Copy Specifications

| | |
|--------------------------|--|
| Colour/Monochrome | Yes/Yes |
| Copy Width | 204 mm ¹ |
| Multiple Copies | Stacks up to 99 pages |
| Enlarge/Reduce | 25% to 400% (in increments of 1%) ² |
| Resolution | Prints up to 1200 × 1800 dpi |

- 1 When copying on A4 size paper.
- 2 When copying using Brother iPrint&Scan.

Scanner Specifications

| | |
|---|--|
| Colour/Monochrome | Yes/Yes |
| TWAIN Compliant | Yes (Windows 7 SP1 / Windows 8.1 / Windows 10 / Windows 11) |
| WIA Compliant | Yes (Windows 7 SP1 / Windows 8.1 / Windows 10 / Windows 11) |
| Colour Depth | 30 bit colour processing (Input) 24 bit colour processing (Output) |
| Greyscale | 10 bit colour processing (Input) 8 bit colour processing (Output) |
| Resolution | Up to 19200 × 19200 dpi (interpolated) ^{1 2} Up to 1200 × 2400 dpi (optical) |
| Scanning Width and Length (Single-sided document) | Width: Up to 213.9 mm Length: Up to 295 mm |

¹ Maximum 1200 × 1200 dpi scanning with the WIA driver in Windows 7 SP1, Windows 8.1, Windows 10 and Windows 11 (resolution up to 19200 × 19200 dpi can be selected using the scanner utility).

² The scanning range may decrease as the scanning resolution increases.

Printer Specifications

| | |
|------------------------------------|---|
| Resolution | Up to 1200 × 6000 dpi (Windows only) |
| Printing Width ¹ | 204 mm Borderless ² : 210 mm |
| Borderless | A4, Letter, A6, Photo (10 x 15 cm), Photo L (9 x 13 cm), Photo 2L (13 x 18 cm), Index card (13 x 20 cm) |
| Print Speed | See your model's page on your local Brother website. |

¹ When printing on A4 size paper.

² When the Borderless feature is set to On.

Interface Specifications

| | |
|--|---|
| USB ^{1 2} | Use a USB 2.0 interface cable that is no longer than 2 m. |
| Wireless LAN (DCP-T420W/DCP-T425W/DCP-T426W) | IEEE 802.11b/g/n (Infrastructure) IEEE 802.11g/n (Wireless Direct) |

¹ Your machine has a USB 2.0 Hi-Speed interface. The machine can also be connected to a computer that has a USB 1.1 interface.

² Third party USB ports are not supported.

Network Specifications



(DCP-T420W/DCP-T425W/DCP-T426W)

You can connect your machine to a network for Network Printing and Network Scanning.

| | |
|---|---|
| Network Security (Wireless) (DCP-T420W/DCP-T425W/DCP-T426W) | SSL/TLS (IPPS, HTTPS) |
| Wireless Network Security (DCP-T420W/DCP-T425W/DCP-T426W) | SSID (32 characters), WEP 64/128 bit, WPA-PSK (TKIP/AES), WPA2-PSK (TKIP/AES) |
| Wireless Setup Support Utility | WPS Yes |

(DCP-T420W/DCP-T425W/
DCP-T426W)

Computer Requirements Specifications

Supported Operating Systems And Software Functions

| Computer Platform & Operating System Version | | PC Interface | | Processor | Hard Disk Space to Install ¹ | |
|--|--|----------------------|--|--|---|--------------------------------------|
| | | USB ² | WLAN(Wi-Fi) | | For Drivers | For Applications (Including Drivers) |
| Windows Operating System | Windows 7 SP1 ^{3 4} ⁵ | Printing Scanning | | 32 bit (x86) or 64 bit (x64) processor | 650 MB | 1.3 GB |
| | Windows 8.1 ^{3 4} | | | | | |
| | Windows 10 Home ^{3 4} | | | | | |
| | Windows 10 Pro ^{3 4} | | | | | |
| | Windows 10 Education ^{3 4} | | | | | |
| | Windows 10 Enterprise ^{3 4} | | | | | |
| | Windows 11 Home ^{3 4} | | | 64 bit (x64) processor | | |
| | Windows 11 Pro ^{3 4} | | | | | |
| | Windows 11 Education ^{3 4} | | | | | |
| | Windows 11 Enterprise ^{3 4} | | | | | |
| | | | | | | |
| Windows Server 2008 ⁵ | Printing Scanning | Printing | 32 bit (x86) or 64 bit (x64) processor | 80 MB | 80 MB | |
| Windows Server 2008 R2 ⁵ | | | | | | |
| Windows Server 2012 | | | | | | |
| Windows Server 2012 R2 | | | | | | |
| Windows Server 2016 | | | | | | |
| Windows Server 2019 | | | | | | |
| Windows Server 2022 | | | | | | |
| | | | | | | |
| Mac Operating System | macOS v10.15.x macOS v11 macOS v12 | Printing Scanning | | 64 bit processor | N/A | 550 MB |

¹ An Internet connection is required to install the software if the Brother installation disc is not supplied.

² Third party USB ports are not supported.

³ For WIA, 1200 x 1200 resolution. Brother Scanner Utility enables enhancing up to 19200 x 19200 dpi.

⁴ Nuance™ PaperPort™ 14SE supports Windows 7 SP1, Windows 8.1, Windows 10 and Windows 11.

⁵ Windows 7 SP1 / Windows Server 2008 / Windows Server 2008 R2 supported by Extend Security Updates until Jan 10, 2023.

For the latest driver updates, go to your model's **Downloads** page at support.brother.com.
All trademarks, brand and product names are the property of their respective companies.

Related Information

- [Appendix](#)
-

Supply Specifications

| | |
|-----------------------------------|---|
| Ink | The machine uses individual Black, Yellow, Cyan and Magenta ink tanks that are separate from the print head assembly. |
| Service Life of Ink Bottle | The first time you fill the tank the machine will use an amount of ink to fill the ink delivery tubes for high quality printouts. This process will only happen once. After this process is complete the ink bottles provided with your machine will have a lower yield than standard ink bottles (approximately 86% for Black and 94% for colour). With all following ink bottles you can print the specified number of pages. |
| Replacement Supplies | <Black Ink Bottle> BTD60BK <Yellow Ink Bottle> BT5000Y <Cyan Ink Bottle> BT5000C <Magenta Ink Bottle> BT5000M Black - Approximately 7500 pages ¹ Yellow, Cyan and Magenta - Approximately 5000 pages ¹ |

¹ Quoted approx. yields are extrapolated based on Brother original methodology using Test Patterns ISO/IEC 24712. Quoted approx. yields are not based on ISO/IEC 24711.

Related Information

- [Appendix](#)

Information Regarding Recycled Paper

- Recycled paper is of the same quality as paper made from original forest sources. Standards governing modern recycled paper ensure that it meets the highest quality requirements for different printing processes. The imaging equipment supplied by Brother is suitable for using with recycled paper meeting the EN 12281:2002 standard.
- Purchasing recycled paper saves natural resources and promotes the circular economy. Paper is made using cellulose fibres from wood. Collecting and recycling paper extends the life of fibres over multiple life cycles, making the best use of the resources.
- The recycled paper production process is shorter. The fibres have already been processed, so less water and energy, and fewer chemicals are used.
- Paper recycling has the benefit of saving carbon by diverting paper products from alternative disposal routes such as landfill and incineration. Landfill waste emits methane gas, which has a powerful greenhouse effect.



Related Information

- [Appendix](#)

Brother Help and Customer Support

If you need help with using your Brother product, visit support.brother.com for FAQs and troubleshooting tips. You can also download the latest software, drivers and firmware, to improve the performance of your machine, and user documentation, to learn how to get the most from your Brother product.

Further product and support information is available from your local Brother office website. Visit <https://global.brother/en/gateway> to find the contact details for your local Brother office and to register your new product.



Related Information

- [Appendix](#)
-

brother



CEE-ENG
Version B