



Online User's Guide

DCP-L5518DN
MFC-L5718DN
MFC-L5728DW

!CAUTION Before using this product, read carefully these instructions for correct operation.
Keep the User's Guide in a secure place for future reference.

Table of Contents

Before You Use Your Machine	1
Definitions of Notes	2
Trademarks	3
Open Source Licensing	4
Copyright and License	5
Important Notes.....	6
Introduction to Your Machine	7
Before Using Your Machine	8
Control Panel Overview	9
How to Navigate the Touchscreen LCD	15
How to Enter Text on Your Machine	16
Set the Main Home Screen	18
Access Brother Utilities (Windows)	19
Uninstall the Software and Drivers (Windows)	20
Input/Output Port Locations on Your Machine	21
Improve Machine Ventilation	22
Paper Handling	24
Load Paper.....	25
Load and Print Using the Paper Tray	26
Load and Print Using the Multi-purpose Tray (MP Tray)	34
Paper Settings.....	42
Change the Paper Size and Paper Type.....	43
Select the Paper Tray For Printing	44
Change the Check Paper Setting.....	45
Recommended Print Media.....	46
Load Documents	47
Load Documents in the Automatic Document Feeder (ADF)	48
Load Documents on the Scanner Glass.....	49
Unscannable and Unprintable Areas	50
Using Special Paper.....	51
Print	52
Print from Your Computer (Windows).....	53
Print a Document (Windows).....	54
Print Settings (Windows)	56
Secure Print (Windows).....	60
Change the Default Print Settings (Windows)	61
Print a Document Using the BR-Script3 Printer Driver (PostScript® 3™ Language Emulation) (Windows)	63
Monitor the Status of the Machine from Your Computer (Windows)	64
Print from Your Computer (Mac)	65
Print Using AirPrint	66
Print Data Directly from a USB Flash Drive	67
Compatible USB Flash Drives	68
Print Data Directly from a USB Flash Drive or Digital Camera Supporting Mass Storage	69
Create a PRN File for Direct Printing (Windows)	71

Print Duplicate Copies.....	72
Change Print Settings Using the Control Panel	73
Cancel a Print Job.....	74
Test Print	75
Scan.....	76
Scan Using the Scan Button on Your Machine	77
Scan Photos and Graphics.....	78
Save Scanned Data to a Folder as a PDF File	80
Save Scanned Data to a USB Flash Drive.....	82
Scan to an Editable Text File (OCR)	84
Save Scanned Data as an Email Attachment	86
Send Scanned Data to an Email Recipient	88
Scan to FTP	90
Scan to SSH Server (SFTP)	94
Scan to Network (Windows).....	101
Scan to SharePoint	107
Use the Web Services Protocol for Network Scanning (Windows 10 and Windows 11).....	111
Change the Scan Button Settings from Brother iPrint&Scan	115
Configure Certificates for Signed PDFs	116
Disable Scanning from Your Computer	118
Scan from Your Computer (Windows).....	119
Scan Using Brother iPrint&Scan (Windows/Mac).....	120
Scan Using Nuance™ PaperPort™ 14SE or Other Windows Applications.....	121
Scan Using Windows Fax and Scan	126
Scan from Your Computer (Mac).....	130
Configure Scan Settings Using Web Based Management.....	131
Set the Scan File Name Using Web Based Management.....	132
Set the Scan Job Email Report Using Web Based Management	133
Copy	134
Copy on One Side of the Paper (1-sided).....	135
Copy on Both Sides of the Paper (2-sided).....	137
Enlarge or Reduce Copied Images	139
Make N in 1 Copies Using the Page Layout Feature.....	140
Copy an ID Card	141
Copy Options	142
Fax	144
Send a Fax.....	145
Send a Fax	146
Send a 2-sided Fax from the ADF	148
Send a Fax Manually.....	149
Send a Fax at the End of a Conversation	150
Set the Fax Logic (Sending and Receiving Sequence).....	151
Send the Same Fax to More than One Recipient (Broadcasting)	152
Send a Fax at a Specified Time (Delayed Fax).....	154
Cancel a Fax in Progress	155
Check and Cancel a Pending Fax.....	156
Fax Options	157

Receive a Fax	158
Receive Mode Settings	159
Voice Operations and Fax Numbers	169
Voice Operations	170
Store Fax Numbers	172
Set up Broadcasting Groups	176
Combine Address Book Numbers	180
Telephone Services and External Devices.....	181
External and Extension Telephones	182
Multi-line Connections (PABX)	187
Fax Reports.....	188
Print a Fax Journal	189
PC-FAX	190
PC-FAX for Windows.....	191
PC-FAX for Mac(Sending only)	210
Network	211
Supported Basic Network Features	212
Configure Network Settings	213
Configure Network Details Using the Control Panel.....	214
Wireless Network Settings	215
Use the Wireless Network	216
Use Wi-Fi Direct®	229
Enable/Disable Wireless LAN	233
Print the WLAN Report.....	234
Network Features.....	238
Enable/Disable Web Based Management Using the Control Panel.....	239
Configure the Proxy Server Settings Using Web Based Management	240
Print the Network Configuration Report.....	241
Configure PC-FAX Receive Using Web Based Management	242
Fax Using the Internet (I-Fax)	243
Use the Send Fax to Server Feature.....	262
Configure and Operate LDAP Search	266
Synchronise Time with the SNTP Server Using Web Based Management	270
Gigabit Ethernet (Wired Network Only)	273
Reset the Network Settings to the Factory Settings.....	275
Security	276
Before Using Network Security Features	277
Disable Unnecessary Protocols	278
Configure Certificates for Device Security	279
Supported Security Certificate Features	280
How to Create and Install a Certificate	281
Create a Self-signed Certificate	282
Create a Certificate Signing Request (CSR) and Install a Certificate from a Certificate Authority (CA)	283
Import and Export the Certificate and Private Key	287
Import and Export a CA Certificate.....	290
Manage Multiple Certificates	293

Use SSL/TLS	294
Introduction to SSL/TLS	295
Manage Your Network Machine Securely Using SSL/TLS	298
Print Documents Securely Using SSL/TLS	302
Use SNMPv3.....	304
Manage Your Network Machine Securely Using SNMPv3	305
Use IPsec.....	306
Introduction to IPsec.....	307
Configure IPsec Using Web Based Management	308
Configure an IPsec Address Template Using Web Based Management	309
Configure an IPsec Template Using Web Based Management	311
Use IEEE 802.1x Authentication for a Wired or a Wireless Network	319
What Is IEEE 802.1x Authentication?	320
Configure IEEE 802.1x Authentication for a Wired or Wireless Network Using Web Based Management (Web Browser).....	321
IEEE 802.1x Authentication Methods.....	323
Use Active Directory Authentication.....	324
Introduction to Active Directory Authentication.....	325
Configure Active Directory Authentication Using Web Based Management	326
Log On to Change the Machine Settings Using the Machine's Control Panel (Active Directory Authentication)	328
Use LDAP Authentication.....	329
Introduction to LDAP Authentication	330
Configure LDAP Authentication Using Web Based Management.....	331
Log On to Change the Machine Settings Using the Machine's Control Panel (LDAP Authentication)	332
Use Secure Function Lock 3.0	333
Before Using Secure Function Lock 3.0.....	334
Configure Secure Function Lock 3.0 Using Web Based Management	335
Scan Using Secure Function Lock 3.0	336
Configure Public Mode for Secure Function Lock 3.0	337
Additional Secure Function Lock 3.0 Features.....	338
Send or Receive an Email Securely.....	339
Configure Email Sending or Receiving Using Web Based Management.....	340
Send an Email with User Authentication	341
Send or Receive an Email Securely Using SSL/TLS	342
Store Print Log to Network	343
Store Print Log to Network Overview	344
Configure the Store Print Log to Network Settings Using Web Based Management.....	345
Use the Store Print Log to Network's Error Detection Setting	347
Use Store Print Log to Network with Secure Function Lock 3.0.....	349
Lock the Machine Settings from the Control Panel	350
Setting Lock Overview.....	351
Use Global Network Detection Features.....	355
Enable Global IP Address Detection	356
Block Communications from the Global Network	357
Administrator.....	358
Network Features.....	359

Security Features	360
Network Security	361
User Authentication	363
Brother Management Tools	364
Mobile Connect	365
AirPrint	366
AirPrint Overview	367
Before Using AirPrint (macOS)	368
Print Using AirPrint	369
Scan Using AirPrint (macOS)	372
Send a Fax Using AirPrint (macOS)	373
Mopria™ Print Service and Mopria™ Scan	374
Brother Mobile Connect	375
WeChat Print	376
Brother iPrint&Scan	377
Access Brother iPrint&Scan (Windows/Mac)	378
Troubleshooting	379
Error and Maintenance Messages	380
Unable to Print or Scan -Transfer Your Faxes	386
Document Jams	390
Document is Jammed in the Top of the ADF Unit	391
Document is Jammed under the Document Cover	392
Remove Small Scraps of Paper Jammed in the ADF	393
Paper Jams	394
Clear Paper Jams	395
Paper is Jammed in the MP tray	396
Paper is Jammed in the Paper Tray	397
Paper is Jammed in the Back of the Machine	399
Paper is Jammed inside the Machine	401
Paper is Jammed in the 2-sided Tray	403
Printing Problems	406
Improve the Print Quality	409
Telephone and Fax Problems	414
Set Dial Tone Detection	417
Set Telephone Line Compatibility for Interference and VoIP Systems	418
Network Problems	419
Error Messages	420
Use the Network Connection Repair Tool (Windows)	422
Check Your Machine's Network Settings	423
I Cannot Complete the Wireless Network Setup Configuration	424
My Machine Cannot Print, Scan, or Use the PC-FAX Receive Function over the Network	426
I Want to Check that My Network Devices are Working Correctly	428
AirPrint Problems	429
Other Problems	430
Check the Machine Information	432
Reset Your Machine	433
Reset Functions Overview	434







Routine Maintenance	435
Replace Supplies	436
Replace the Toner Cartridge	438
Replace the Drum Unit	441
Clean the Machine	444
Clean the Scanner	446
Clean the Touchscreen LCD	448
Clean the Corona Wire	449
Clean the Drum Unit	451
Clean the Paper Pick-up Rollers	455
Check the Remaining Part Life	457
Pack the Machine and the Toner Cartridge Together	458
Replace Periodic Maintenance Parts	460
Machine Settings	461
Change Machine Settings from the Control Panel	462
In the Event of Power Failure (Memory Storage)	463
General Settings	464
Save Your Favourite Settings as a Shortcut	481
Print Reports	484
Settings and Features Tables	487
Change Machine Settings Using Web Based Management	523
What is Web Based Management?	524
Access Web Based Management	525
Set or Change a Login Password for Web Based Management	527
Set Up Your Machine's Address Book Using Web Based Management	528
Appendix	529
Specifications	530
Supplies	537
Accessories	538
Notice	539
Brother Help and Customer Support	540

Before You Use Your Machine

- [Definitions of Notes](#)
- [Trademarks](#)
- [Open Source Licensing](#)
- [Copyright and License](#)
- [Important Notes](#)

Definitions of Notes

We use the following symbols and conventions throughout this User's Guide:

 WARNING	WARNING indicates a potentially hazardous situation which, if not avoided, could result in death or serious injuries.
 CAUTION	CAUTION indicates a potentially hazardous situation which, if not avoided, may result in minor or moderate injuries.
IMPORTANT	IMPORTANT indicates a potentially hazardous situation which, if not avoided, may result in damage to property or loss of product functionality.
NOTE	NOTE specifies the operating environment, conditions for installation, or special conditions of use.
	Tips icons indicate helpful hints and supplementary information.
	Electrical Hazard icons alert you to possible electrical shock.
	Fire Hazard icons alert you to the possibility of a fire.
	Hot Surface icons warn you not to touch hot machine parts.
	Prohibition icons indicate actions you must not perform.
Bold	Bold style identifies buttons on the machine's control panel or computer screen.
<i>Italics</i>	Italicised style emphasises an important point or refers you to a related topic.
Courier New	Courier New font identifies messages shown on the machine's LCD.



Related Information

- [Before You Use Your Machine](#)

Trademarks

Apple, App Store, AirPrint, Mac, macOS, iPadOS, iPad, iPhone, iPod touch, and Safari are trademarks of Apple Inc., registered in the U.S. and other countries.

Nuance and PaperPort are trademarks or registered trademarks of Nuance Communications, Inc. or its affiliates in the United States and/or other countries.

Adobe®, Reader®, PostScript and PostScript 3 are either registered trademarks or trademarks of Adobe Systems Incorporated in the United States and/or other countries.

Wi-Fi®, Wi-Fi Alliance®, and Wi-Fi Direct® are registered trademarks of Wi-Fi Alliance®.

WPA™, WPA2™, WPA3™, Wi-Fi CERTIFIED, and Wi-Fi Protected Setup are trademarks of Wi-Fi Alliance®.

Android and Google Play are trademarks of Google LLC. Use of these trademarks is subject to Google Permissions.

Mopria™ and the Mopria™ Logo are registered and/or unregistered trademarks and service marks of Mopria Alliance, Inc. in the United States and other countries. Unauthorised use is strictly prohibited.

The Bluetooth® word mark is a registered trademark owned by Bluetooth SIG, Inc. and any use of such marks by Brother Industries, Ltd. is under license. Other trademarks and trade names are those of their respective owners.

Each company whose software title is mentioned in this manual has a Software Licence Agreement specific to its proprietary programs.

Software Trademarks

FlashFX® is a registered trademark of Datalight, Inc.

FlashFX® Pro™ is a trademark of Datalight, Inc.

FlashFX® Tera™ is a trademark of Datalight, Inc.

Reliance™ is a trademark of Datalight, Inc.

Reliance Nitro™ is a trademark of Datalight, Inc.

Datalight® is a registered trademark of Datalight, Inc.

Any trade names and product names of companies appearing on Brother products, related documents and any other materials are all trademarks or registered trademarks of those respective companies.



Related Information

- [Before You Use Your Machine](#)

Open Source Licensing

This product includes open source software.

To view Open Source Licensing Remarks and Copyright Information, go to your model's **Manuals** page at support.brother.com/manuals.



Related Information

- [Before You Use Your Machine](#)
-

Copyright and License

©2023 Brother Industries, Ltd. All rights reserved.

This product includes software developed by the following vendors:

This product includes the "KASAGO TCP/IP" software developed by ZUKEN ELMIC, Inc.

Copyright 1989-2020 Datalight, Inc., All Rights Reserved.

FlashFX® Copyright 1998-2020 Datalight, Inc.



Related Information

- [Before You Use Your Machine](#)

Important Notes

- Check support.brother.com/downloads for Brother driver and software updates.
- To keep your machine performance up to date, check support.brother.com/downloads for the latest firmware update. Otherwise, some of your machine's functions may not be available.
- Do not use this product outside the country of purchase as it may violate the wireless telecommunication and power regulations of that country.
- Before giving your machine to anyone else, replacing it, or disposing of it, we strongly recommend resetting it to its factory settings to remove all personal information.
- Windows 10 in this document represents Windows 10 Home, Windows 10 Pro, Windows 10 Education, and Windows 10 Enterprise.
- Windows 11 in this document represents Windows 11 Home, Windows 11 Pro, Windows 11 Education, and Windows 11 Enterprise.
- For macOS v13 Users:
This machine supports macOS v13.
For machine setup and software installation instructions, see the *Quick Setup Guide* included in the carton.
All features in macOS v11 and macOS v12 are available in the macOS v13 environment and work in a similar way.
- The screens or images in this User's Guide are for illustration purposes only and may differ from those of the actual products.
- Unless otherwise specified, the screens in this manual are from Windows 10. Screens on your computer may vary depending on your operating system.
- The contents of this document and the specifications of this product are subject to change without notice.



Related Information

- [Before You Use Your Machine](#)

Introduction to Your Machine

- [Before Using Your Machine](#)
- [Control Panel Overview](#)
- [How to Navigate the Touchscreen LCD](#)
- [How to Enter Text on Your Machine](#)
- [Set the Main Home Screen](#)
- [Access Brother Utilities \(Windows\)](#)
- [Input/Output Port Locations on Your Machine](#)
- [Improve Machine Ventilation](#)

Before Using Your Machine

Before attempting any printing operation, confirm the following:

- Make sure you have installed the correct software and drivers for your machine.
- For USB or network cable users: Make sure the interface cable is physically secure.

Simultaneous printing, scanning, and faxing

Your machine can print from your computer while sending or receiving a fax into memory or while scanning a document into the computer. Fax sending will not be stopped during printing from your computer. However, when the machine is copying or receiving a fax on paper, it pauses the printing operation, and then continues printing when copying or fax receiving has finished.



DCP models do not support the fax feature.

Firewall (Windows)

If your computer is protected by a firewall and you are unable to network print, network scan, or PC-FAX, you may need to configure the firewall settings. If you are using the Windows Firewall and you installed the drivers using the steps in the installer, the necessary firewall settings have been already set. If you are using any other personal firewall software, see the User's Guide for your software or contact the software manufacturer.



Related Information

- [Introduction to Your Machine](#)

Control Panel Overview

The control panel may vary depending on your model.

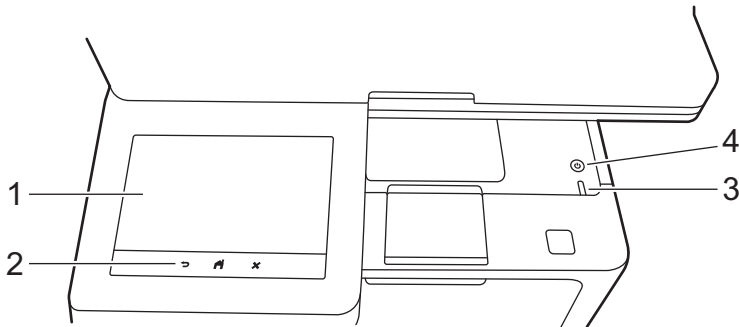

1. Touchscreen Liquid Crystal Display (LCD)

You can select from two types of screens to set as the Main Home screen: Home screens and Shortcuts screens. When a Home screen is displayed, swipe left or right or press ◀ or ▶ to display the other Home screens.

The Main Home screen displays the machine's status when the machine is idle. When displayed, this screen indicates that your machine is ready for the next command.

If Active Directory Authentication or LDAP Authentication is enabled, the machine's control panel is locked.

The available features vary depending on your model.

The Home screens provide access to features, such as Fax, Copy, and Scan.

Home screen: Screen 1

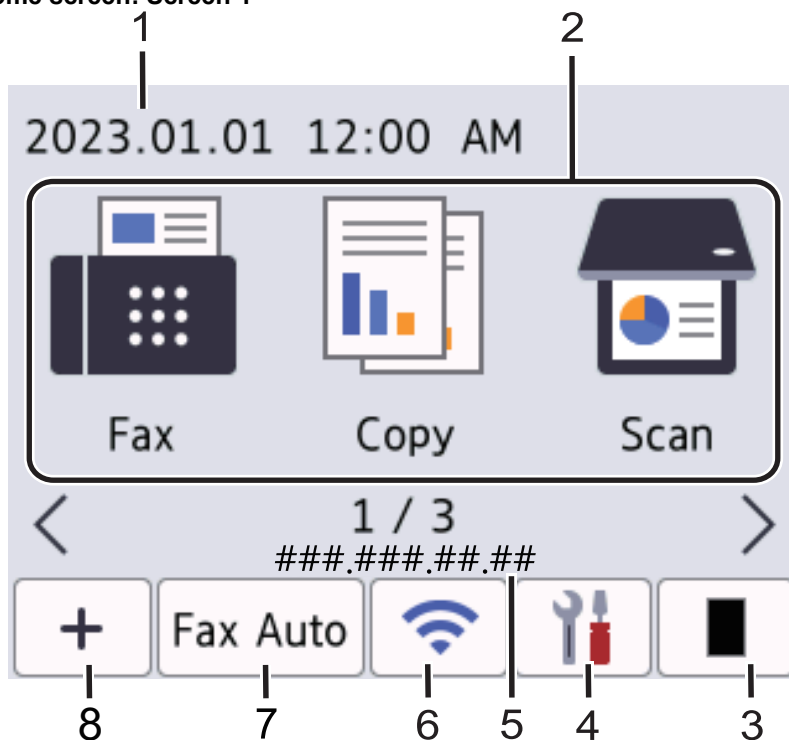

Home screen: Screen 2

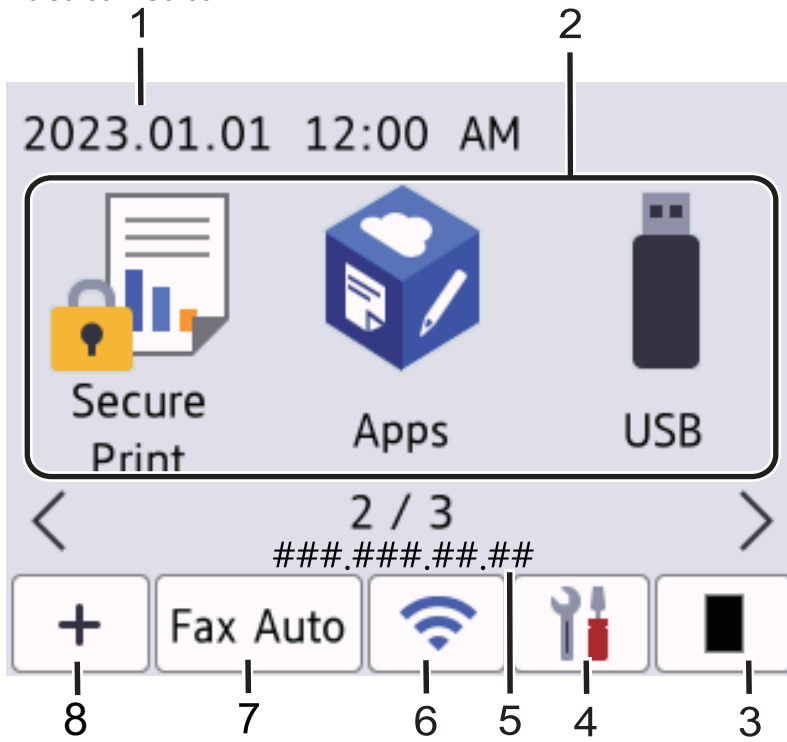

Home screen: Screen 3

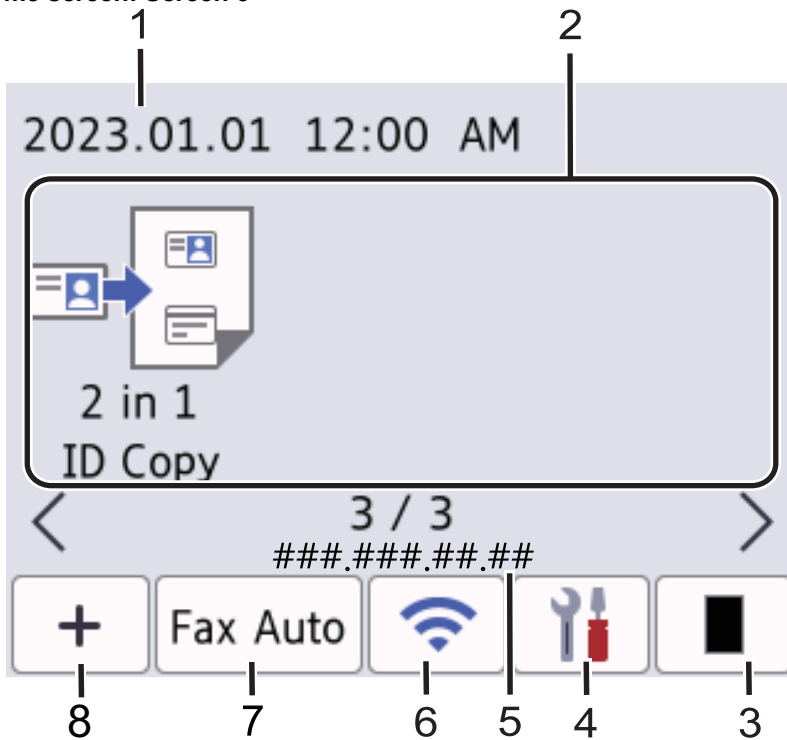

Shortcuts screen

Create Shortcuts for frequently used operations, such as sending a fax, making a copy, and scanning.





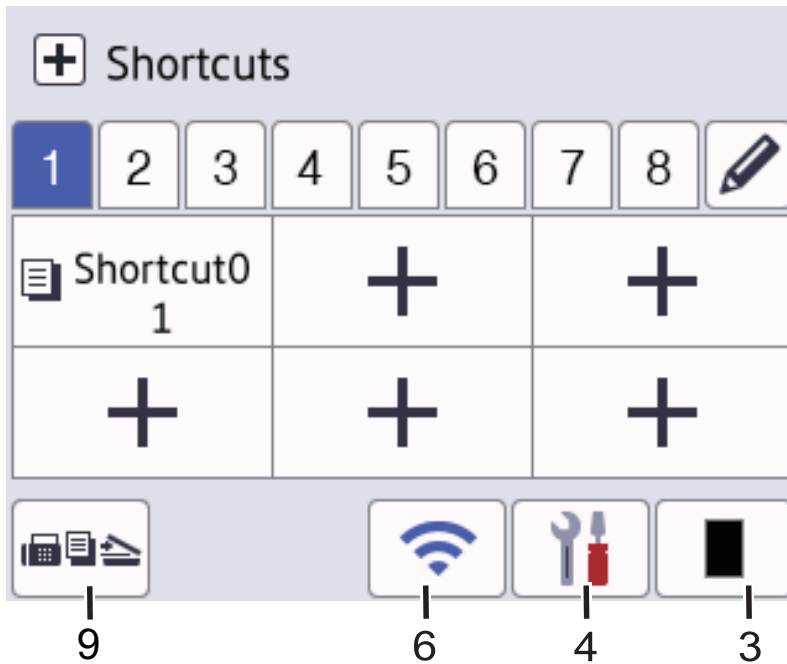



Eight Shortcuts tabs are available with six Shortcuts on each Shortcuts tab. A total of 48 Shortcuts are available.



1. **Date & Time**

Displays the date and time set on the machine.

2. **Function Icons**

-  **[Fax]** (MFC-L5718DN/MFC-L5728DW)
Press to access Fax mode.
-  **[Copy]**
Press to access Copy mode.
-  **[Scan]**
Press to access Scan mode.
-  **[Secure Print]**
Press to access the [Secure Print] option.
-  **[Apps]**
Press to connect your machine to the Brother Apps service.
-  **[USB]**
Press to access the USB menu and select [Scan to USB] or [Direct Print] options.
-  **[2 in 1 ID Copy]**
Press to access the 2 in 1 ID Copy option.

3. **(Toner)**

Displays the remaining toner life. Press to access the [Toner] menu.





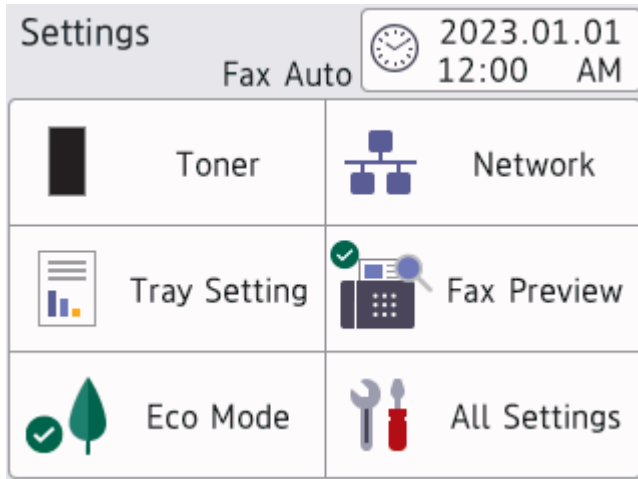

4. **(Settings)**

Press to access the [Settings] menu.



If the Setting Lock function has been turned on, a lock  icon appears on the LCD. You must unlock the machine to change the settings.



-  **Toner**
 - Displays the remaining toner life.
 - Press to access the [Toner] menu.
-  **Network**
 - Press to set up a network connection.
 - A four level indicator on the screen displays the current wireless signal strength if you are using a wireless connection.
-  **Fax Preview** (MFC-L5718DN/MFC-L5728DW)
Press to access the [Fax Preview] menu.
-  **Tray Setting**
Press to access the [Tray Setting] menu.
-  **Eco Mode**
Press to access the [Eco Mode] menu.
-  **All Settings**
Press to access all machine settings.
-  **Date & Time**
 - Displays the date and time set on the machine.
 - Press to access the [Date & Time] menu.

5. IP Address

If the IP Address setting in the Display Information menu has been turned on, your machine's IP Address appears on the Home screens.

-
6.  or  (**Wireless Status**) for wireless network models

Press to configure the wireless settings.

If you are using a wireless connection, a four-level indicator displays the current wireless signal strength.



-  (**Wired LAN Status**) for wired network models

Press to configure the Wired LAN settings.

The icon displays the current wired network status.

7. **Fax mode setting**

Press to change the Fax receive mode.



The machine will transfer the received fax data to the designated computer and the fax data will not remain in your machine in the PC-Fax mode. Machine will print received faxes if you turn on the backup print setting.

To change the backup print setting, press  [Settings] > [All Settings] > [Fax] > [Setup Receive] > [Receive Mode] > [PC Fax Receive]

-
8.  [Shortcuts]

Press to access the [Shortcuts] screen.

9.  (**Home screen**)

Press to access the Home screens.

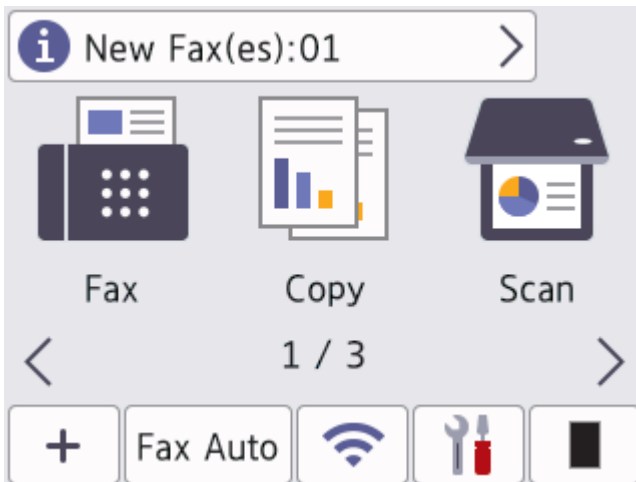

- **New Fax (MFC-L5718DN/MFC-L5728DW)**

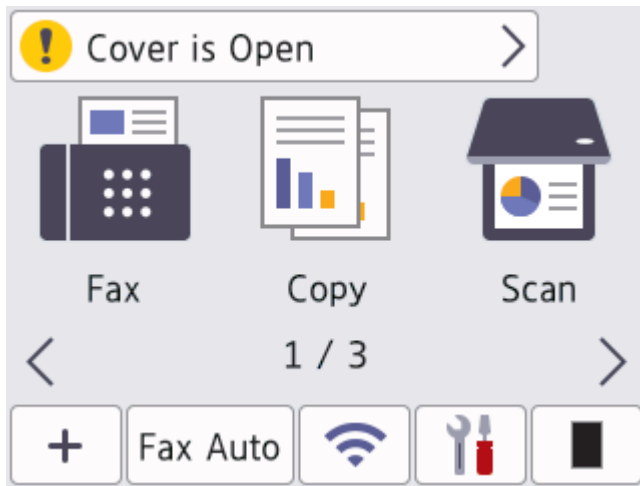

When [Fax Preview] is set to [On], the number of new faxes you received into the memory appears at the top of the screen.

- **Warning Icon**



The warning icon  appears when there is an error or maintenance message. Press the message area to view it, and then press  to return to the Main Home screen.

2. Touchpanel



(Back)

Press to go back to the previous menu.



(Home)

Press to return to the Main Home screen.





(Cancel)

Press to cancel an operation.

3. LED Power Indicator

The LED lights up depending on the machine's power status.

4. Power On/Off

- Turn the machine on by pressing .
- Turn the machine off by holding down . The LCD displays [Shutting Down] for a few seconds before the machine turns off. If you have an external telephone or TAD connected, it is still available.



Related Information

- [Introduction to Your Machine](#)

How to Navigate the Touchscreen LCD

Press your finger on the LCD to operate it. To display and access all the options, swipe left, right, up, and down, or press ◀, ▶, ▲, or ▼ on the LCD to scroll through them.

IMPORTANT

DO NOT press the LCD with a sharp object, such as a pen or stylus. It may damage the machine.

NOTE

DO NOT touch the LCD immediately after plugging in the power cord or turning the machine on. Doing this may cause an error.



This product uses fonts owned by ARPHIC TECHNOLOGY CO., LTD.



Related Information

- [Introduction to Your Machine](#)

How to Enter Text on Your Machine

- When you must enter text on your machine, a keyboard appears on the LCD.
- The characters that are available may differ depending on your country.
- The keyboard layout may differ depending on the operation you perform.
- The keyboard display may differ depending on your model.



- Press to cycle between letters, numbers, and special characters.
- Press to cycle between lowercase and uppercase letters.
- To move the cursor to the left or right, press ◀ or ▶.

Inserting spaces

- To enter a space, press [Space] or ▶.

Making corrections

- If you entered a character incorrectly and want to change it, press ◀ or ▶ to move the cursor to the incorrect character, and then press . Enter the correct character.
- To insert a character, press ◀ or ▶ to move the cursor to the correct place, and then enter the character.
- Press for each character you want to erase, or press and hold to erase all the characters.

✓ Related Information

- [Introduction to Your Machine](#)

Related Topics:



- [Configure Your Machine for a Wireless Network Using the Machine's Control Panel Setup Wizard](#)
- [Configure Your Machine for a Wireless Network When the SSID Is Not Broadcast](#)
- [Set Your Station ID](#)

-
- Set the Setting Lock Password
-

Set the Main Home Screen

You can change the LCD to display a specific Home screen or Shortcut screen.

When the machine is idle or you press , the touchscreen will return to the screen you set.

1. Press  [Settings] > [All Settings] > [General Setup] > [Screen Settings] > [Home Screen].
2. Swipe up or down or press ▲ or ▼ to display the screen settings, and then press the setting you want.
3. Press .

The LCD displays the screen you selected. You can change this main screen as needed.





Related Information

- [Introduction to Your Machine](#)
-

Access Brother Utilities (Windows)

Brother Utilities is an application launcher that offers convenient access to all Brother applications installed on your computer.

1. Do one of the following:
 - (Windows 11)
Click  > **All apps** > **Brother** > **Brother Utilities**.
 - (Windows 10)
Click  > **Brother** > **Brother Utilities**.
2. Select your machine.

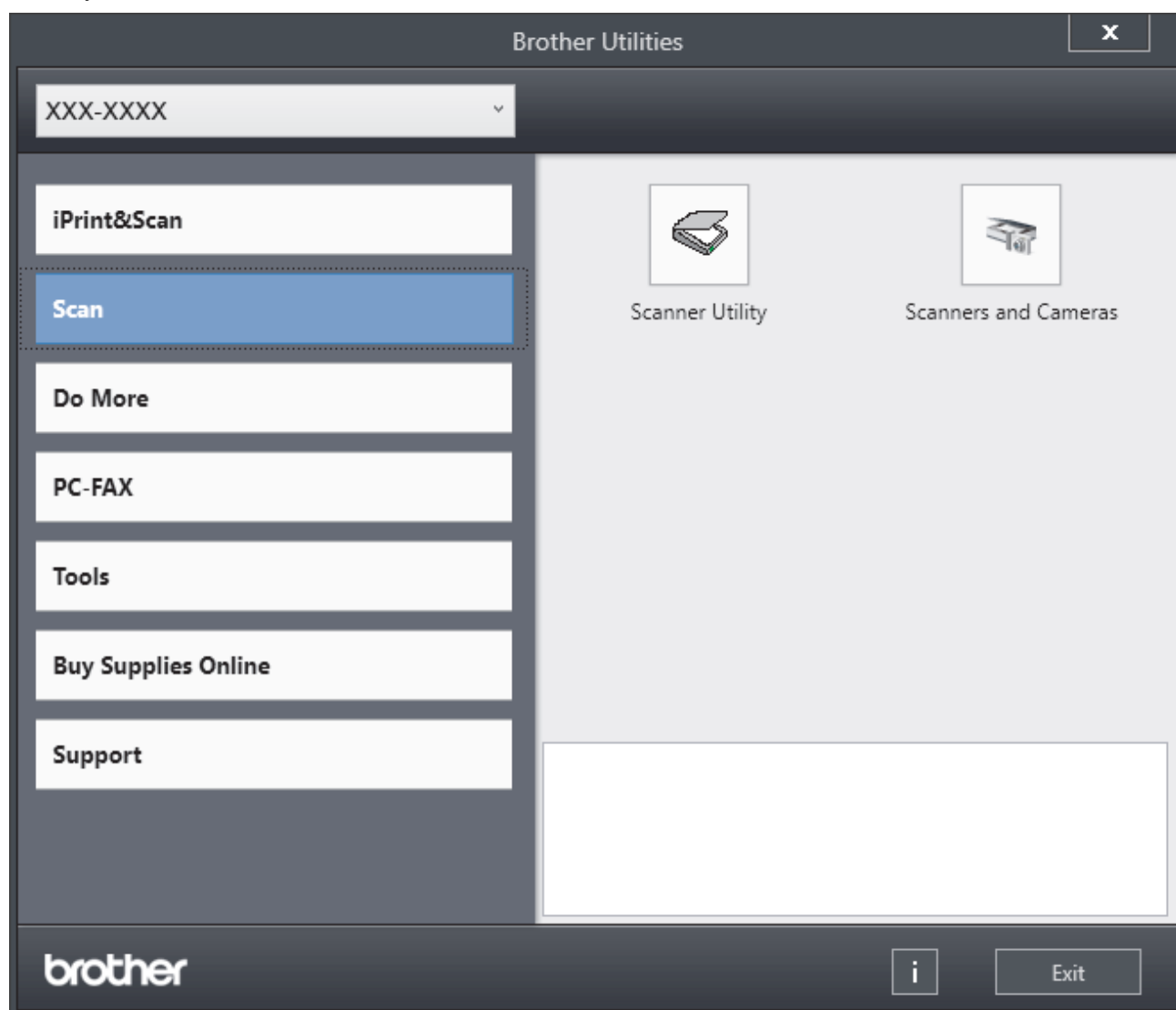



3. Choose the option you want.

✓ Related Information

- [Introduction to Your Machine](#)
 - [Uninstall the Software and Drivers \(Windows\)](#)

Uninstall the Software and Drivers (Windows)

1. Do one of the following:
 - Windows 11
Click  > **All apps** > **Brother** > **Brother Utilities**.
 - Windows 10
Click  > **Brother** > **Brother Utilities**.
2. Select your model from the drop-down list (if it is not already selected).
3. Click **Tools** in the left navigation bar.
 - If the **Software Update Notification** icon is visible, select it, and then click **Check now** > **Check for Software Updates** > **Update**. Follow the on-screen instructions.
 - If the **Software Update Notification** icon is not visible, go to the next step.
4. Click **Uninstall** in the **Tools** section of **Brother Utilities**.
Follow the instructions in the dialog box to uninstall the software and drivers.



Related Information

- [Access Brother Utilities \(Windows\)](#)

Input/Output Port Locations on Your Machine

The input/output ports are located on the front and back of the machine.

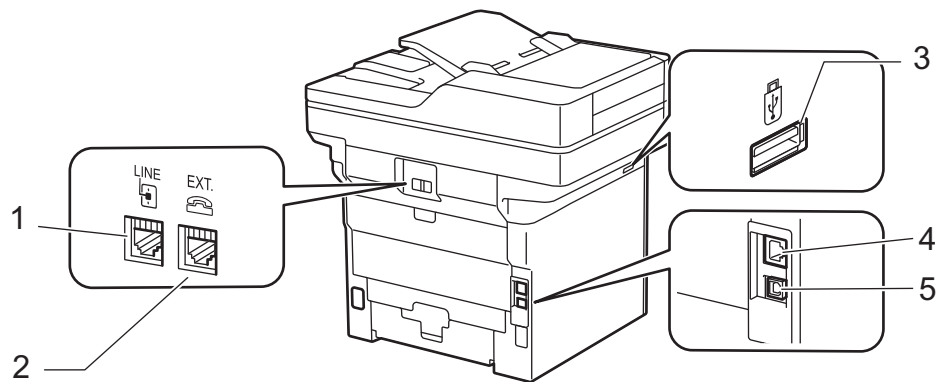

1. LINE socket (For MFC models)
2. EXT. socket (For MFC models)
3. USB accessory port (Front)
DCP-L5518DN/MFC-L5718DN/MFC-L5728DW
4. 10BASE-T / 100BASE-TX / 1000BASE-T port (For network models)
5. USB port

When connecting the USB or network cable, follow the instructions in the software/driver installer.

To install the necessary driver and software for operating your machine, go to your model's **Downloads** page at support.brother.com/downloads.

✓ Related Information

- [Introduction to Your Machine](#)

Improve Machine Ventilation

Rotate the main vent cover to redirect the flow of air from inside of the machine.

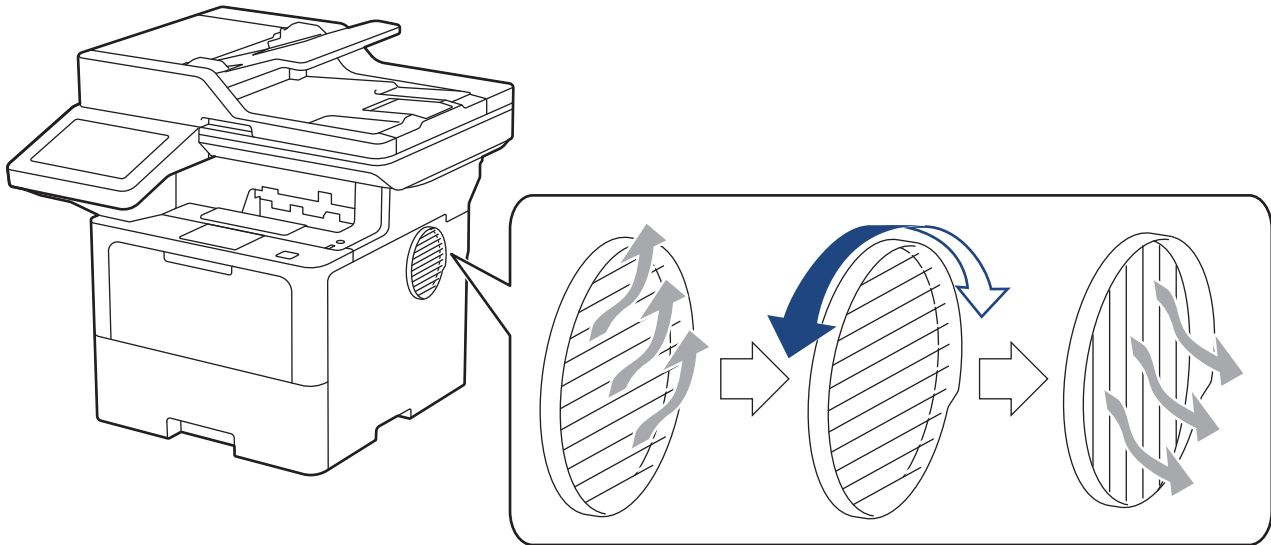

CAUTION

- Be careful not to get burned when rotating the vent. It may get hot.
- Keep a minimum gap around the product as shown in the illustration.

Front

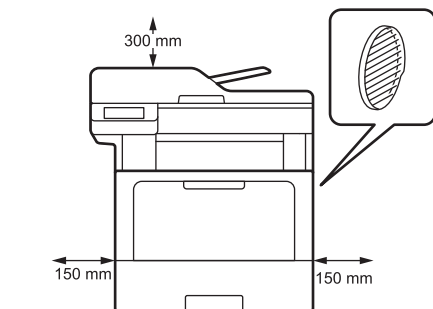

Side

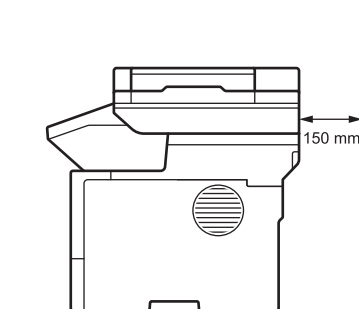

Front

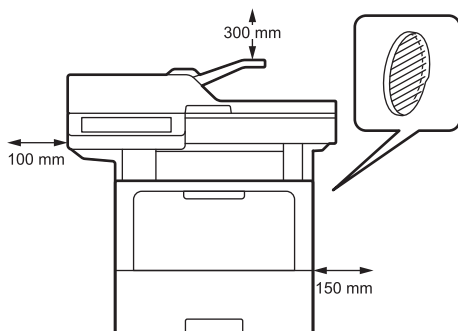

Side

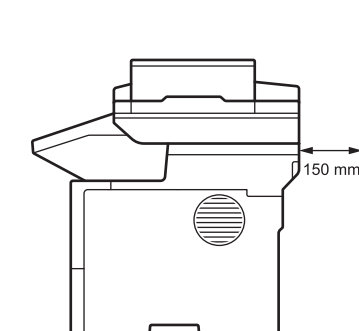

NOTE

DO NOT put the product in a location where any slot or opening is blocked or obstructed. These slots and openings are provided for ventilation.



Related Information

- [Introduction to Your Machine](#)
-

Paper Handling

- [Load Paper](#)
- [Paper Settings](#)
- [Recommended Print Media](#)
- [Load Documents](#)
- [Unscannable and Unprintable Areas](#)
- [Using Special Paper](#)

Load Paper

- [Load and Print Using the Paper Tray](#)
- [Load and Print Using the Multi-purpose Tray \(MP Tray\)](#)

Load and Print Using the Paper Tray

- [Load Paper in the Paper Tray](#)
- [Load and Print Thick Paper Using the Paper Tray](#)
- [Printing Problems](#)
- [Error and Maintenance Messages](#)

Load Paper in the Paper Tray

- If, when the Check Paper setting is set to On and you pull the paper tray out of the machine, a message appears on the LCD asking if you want to change the paper size and paper type, change these settings, if needed, following the LCD instructions.
- When you load a different size and type of paper in the tray, you must also change the Paper Size and Paper Type settings on the machine, or on your computer.

1. Pull the paper tray completely out of the machine.

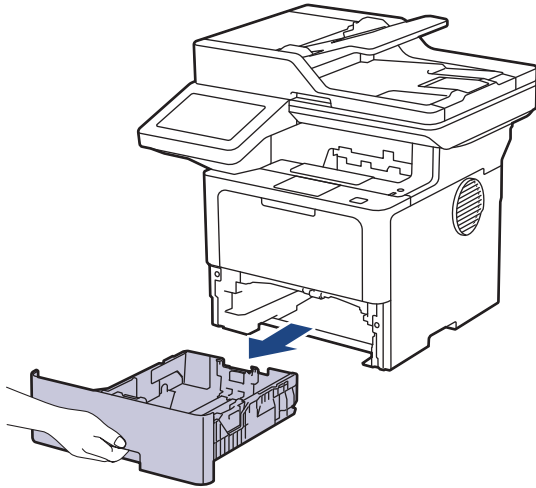

2. Press the green levers to slide the paper guides to fit the paper.

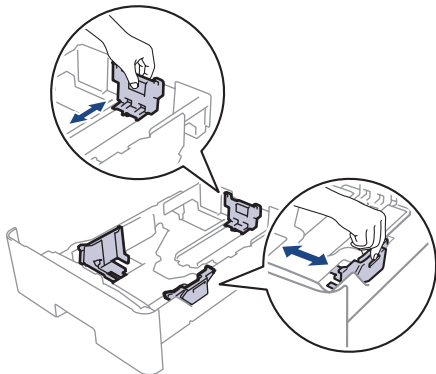



For Legal or Folio size paper, press the release button (1) in the bottom of the paper tray or the release lever (2) in the back of the tray, and then pull out the back of the paper tray. (Legal and Folio size paper are not available in some regions.)

For trays with a release button:

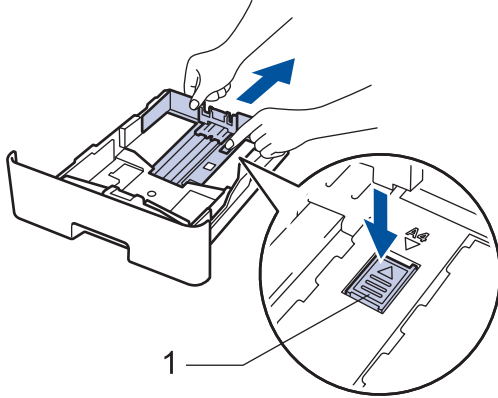

For trays with a release lever:

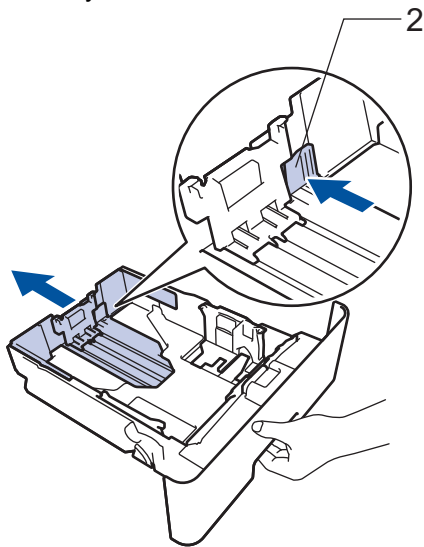

3. Fan the stack of paper well.
4. Load paper in the paper tray with the printing surface *face down*.



When you use letterhead or preprinted paper, load the paper in the correct orientation. See *Related Information: Change Machine Settings to Print on Letterhead or Preprinted Paper Using the Paper Tray*.

5. Make sure the paper is below the maximum paper mark (▼▼▼).
Overfilling the paper tray will cause paper jams.

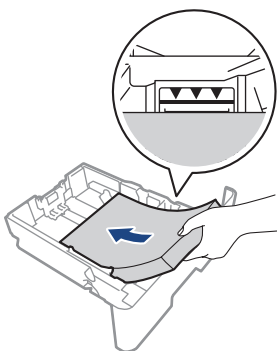

6. Slowly push the paper tray completely into the machine.

7. Lift the support flap to prevent paper from sliding off the output tray.

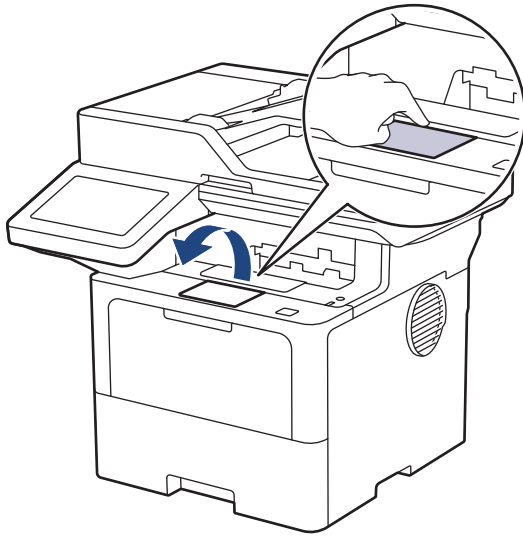

Related Information

- [Load and Print Using the Paper Tray](#)
 - [Change Machine Settings to Print on Letterhead or Preprinted Paper Using the Paper Tray](#)
-

Change Machine Settings to Print on Letterhead or Preprinted Paper Using the Paper Tray

When you use letterhead or preprinted paper for 2-sided printing, change the machine's settings.



- DO NOT load different sizes and types of paper in the paper tray at the same time. Doing this may cause the paper to jam or misfeed.
- If the print position is misaligned with the letterhead or preprinted objects, the print position is adjustable using the Print Position setting for the paper tray.
- Some preprinted paper may cause print stains, depending on the printing method and ink type.

Orientation

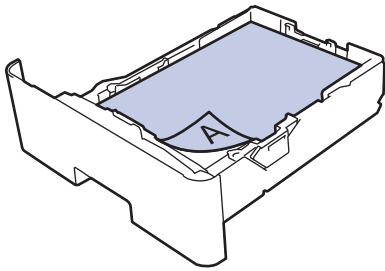
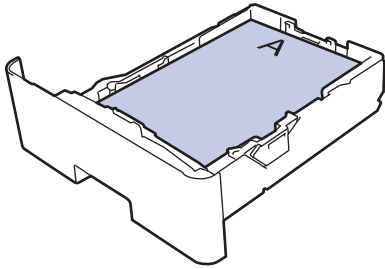
	<p>For 1-sided printing</p> <ul style="list-style-type: none">• face down• top edge towards the front of the paper tray
	<p>For automatic 2-sided printing (long edge binding)</p> <ul style="list-style-type: none">• face up• bottom edge towards the front of the paper tray

1. Press  [Settings] > [All Settings] > [Printer] > [2-sided] > [Single Image] > [2-sided Feed].



If your machine displays the [All Settings] menu on the Home screen, skip the [Settings] menu.

2. Press .



Related Information

- [Load Paper in the Paper Tray](#)

Load and Print Thick Paper Using the Paper Tray

- If, when the Check Paper setting is set to On and you pull the paper tray out of the machine, a message appears on the LCD asking if you want to change the paper size and paper type, change these settings, if needed, following the LCD instructions.
- When you load a different size and type of paper in the tray, you must also change the Paper Size and Paper Type settings on the machine, or on your computer.

1. Pull the paper tray completely out of the machine.

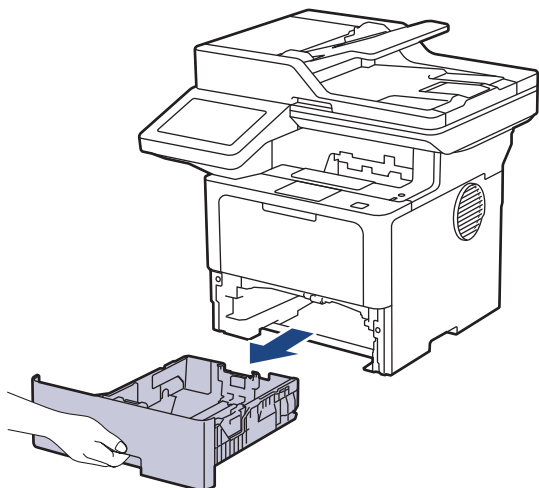

2. Press the green levers to slide the paper guides to fit the paper.

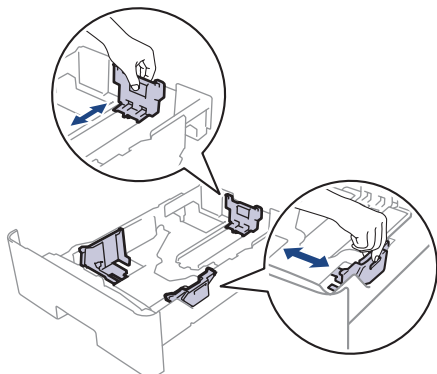



For Legal or Folio size paper, press the release button (1) in the bottom of the paper tray or the release lever (2) in the back of the tray, and then pull out the back of the paper tray. (Legal and Folio size paper are not available in some regions.)

For trays with a release button:

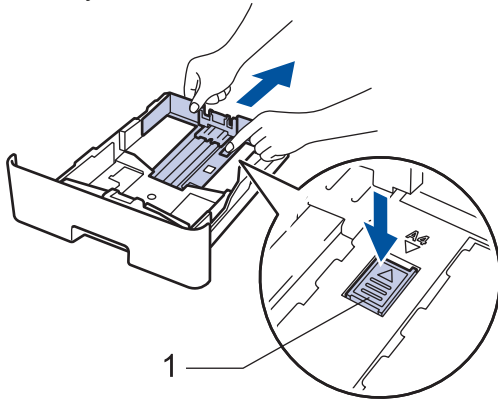

For trays with a release lever:

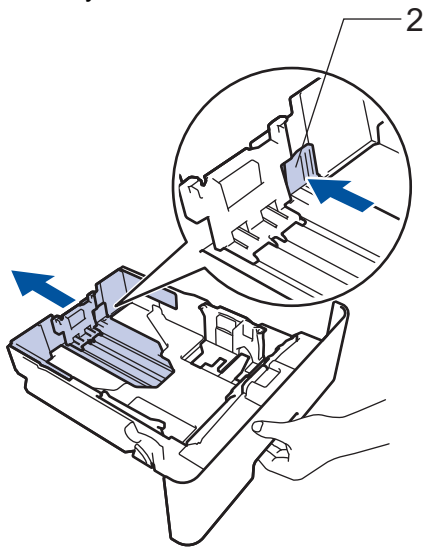

3. Fan the stack of paper well.
4. Load paper in the paper tray with the printing surface *face down*.



DO NOT load different sizes and types of paper in the paper tray at the same time. Doing this may cause the paper to jam or misfeed.

5. Make sure the paper is below the maximum paper mark (▼▼▼).
Overfilling the paper tray will cause paper jams.

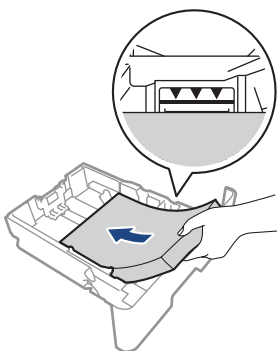

6. Slowly push the paper tray completely into the machine.

7. Open the machine's back cover (the face up output tray).

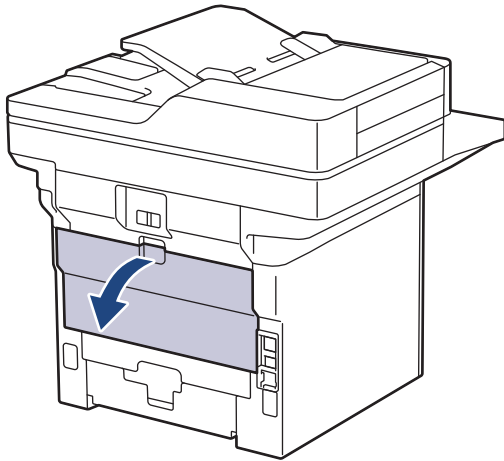

8. Send your print job to the machine.



Change your print preferences in the Print dialog box.

9. When finished, close the back cover (the face up output tray) until it locks in the closed position.



Related Information

- [Load and Print Using the Paper Tray](#)

Load and Print Using the Multi-purpose Tray (MP Tray)

- [Load Paper in the Multi-purpose Tray \(MP Tray\)](#)
- [Load and Print Labels Using the MP Tray](#)
- [Load and Print Envelopes Using the MP Tray](#)
- [Printing Problems](#)
- [Error and Maintenance Messages](#)

Load Paper in the Multi-purpose Tray (MP Tray)

When you load a different size and type of paper in the tray, you must also change the Paper Size and Paper Type settings on the machine, or on your computer.

- Plain Paper
- Thin Paper
- Thick Paper
- Recycled Paper
- Bond Paper
- Letterhead
- Coloured Paper

1. Lift the support flap to prevent paper from sliding off the face down output tray.

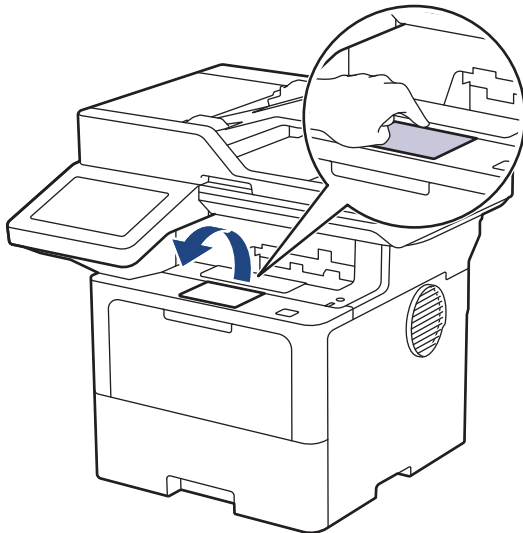

2. Open the MP tray and lower it gently.

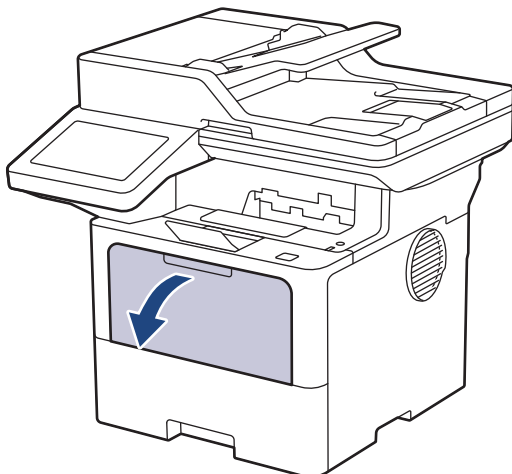

-
3. Extend the MP tray support.

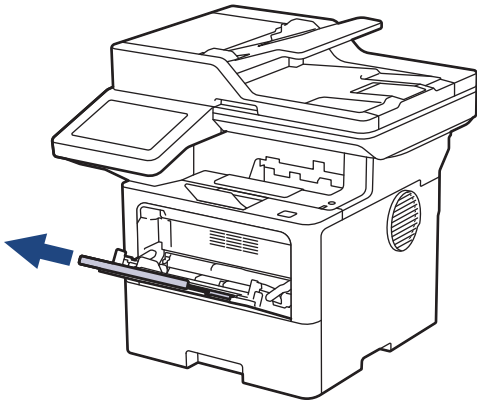

4. Slide the MP tray paper guides to fit the width of the paper you are using.

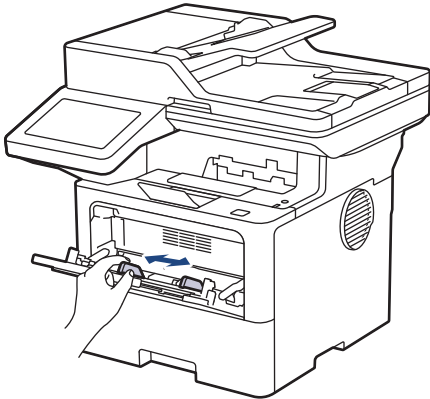

5. Load paper with the printing surface *face up* in the MP tray.

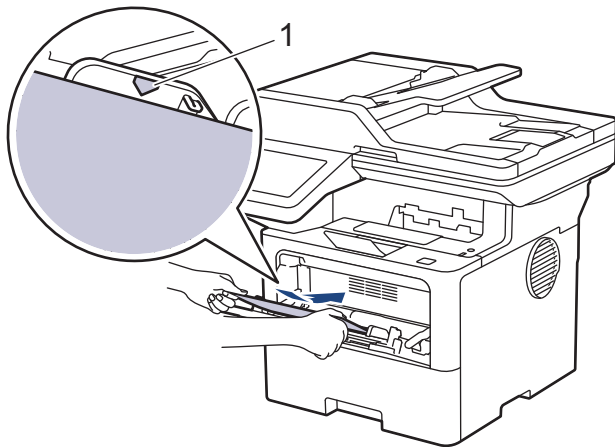

- Make sure the paper is below the maximum paper mark (1).
- When you use letterhead or preprinted paper, load the paper in the correct orientation. See *Related Information: Change Machine Settings to Print on Letterhead or Preprinted Paper Using the MP Tray*.

✓ Related Information

- [Load and Print Using the Multi-purpose Tray \(MP Tray\)](#)
 - [Change Machine Settings to Print on Letterhead or Preprinted Paper Using the MP Tray](#)

Change Machine Settings to Print on Letterhead or Preprinted Paper Using the MP Tray

When you use letterhead or preprinted paper for 2-sided printing, change the machine's settings.



- DO NOT load different sizes and types of paper in the paper tray at the same time. Doing this may cause the paper to jam or misfeed.
- If the print position is misaligned with the letterhead or preprinted objects, the print position is adjustable using the Print Position setting for the MP tray.
- Some preprinted paper may cause print stains, depending on the printing method and ink type.

Orientation

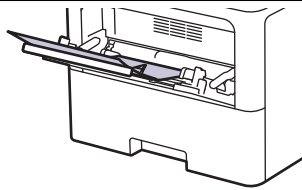
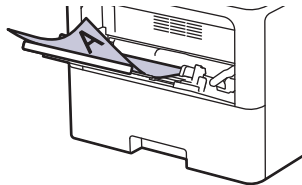
	For 1-sided printing <ul style="list-style-type: none">• face up• top edge first
	For automatic 2-sided printing (long edge binding) <ul style="list-style-type: none">• face down• bottom edge first

1. Press  [Settings] > [All Settings] > [Printer] > [2-sided] > [Single Image] > [2-sided Feed].



If your machine displays the [All Settings] menu on the Home screen, skip the [Settings] menu.

2. Press .



Related Information

- [Load Paper in the Multi-purpose Tray \(MP Tray\)](#)

Load and Print Labels Using the MP Tray

When you print on labels, open the back cover (face up output tray) and use the MP tray.

When you load a different size and type of paper in the tray, you must also change the Paper Size and Paper Type settings on the machine, or on your computer.

1. Open the machine's back cover (the face up output tray).

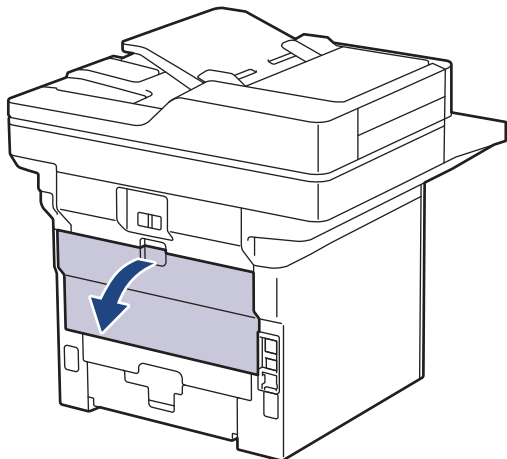

2. On the front of the machine, open the MP tray and lower it gently.

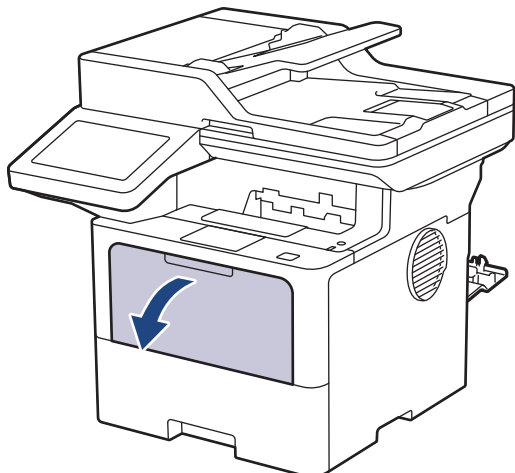

3. Extend the MP tray support.

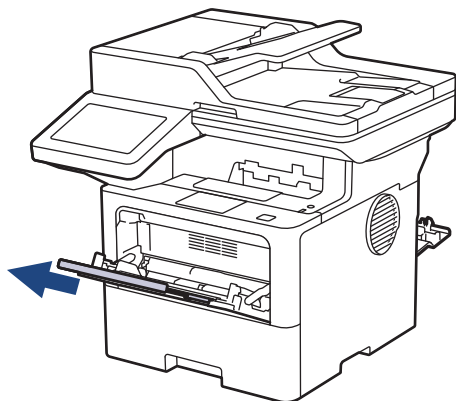

-
- Slide the MP tray paper guides to fit the width of the labels you are using.

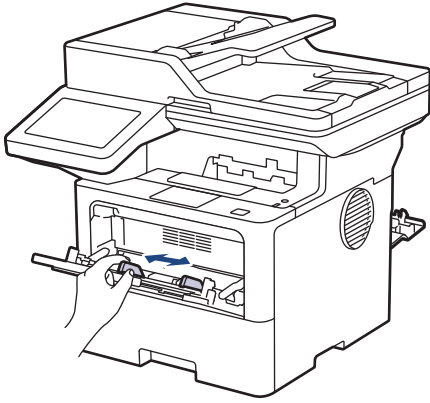

- Load labels with the printing surface *face up* in the MP tray.

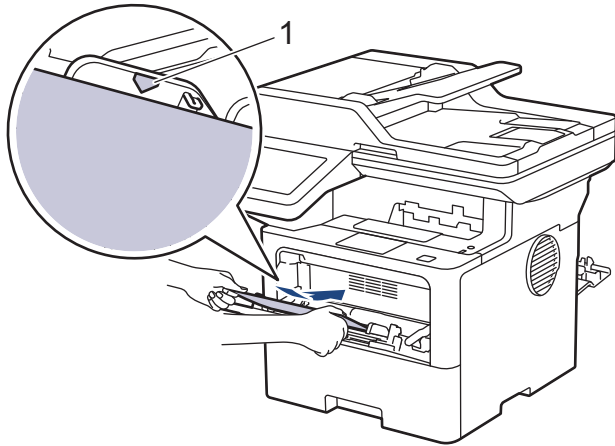

Make sure the labels are below the maximum paper mark (1).

- Change your print preferences in the Print screen.
- Send your print job to the machine.
- When finished, close the back cover (the face up output tray) until it locks in the closed position.



Related Information

- [Load and Print Using the Multi-purpose Tray \(MP Tray\)](#)
-

Load and Print Envelopes Using the MP Tray

Before loading, press the corners and sides of the envelopes to make them as flat as possible.

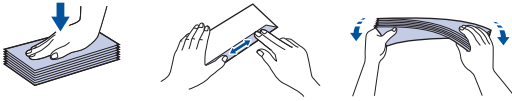

When you load a different size and type of paper in the tray, you must also change the Paper Size and Paper Type settings on the machine, or on your computer.

1. Open the machine's back cover (the face up output tray).

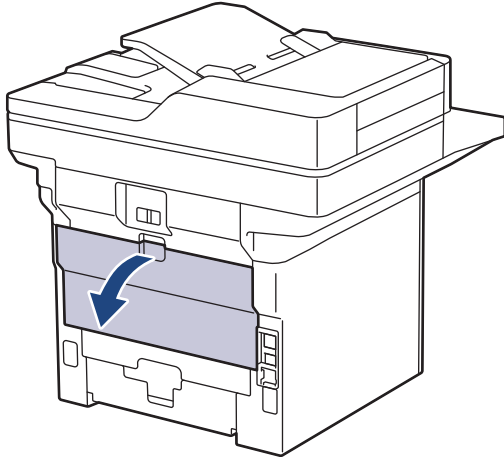

2. On the front of the machine, open the MP tray and lower it gently.

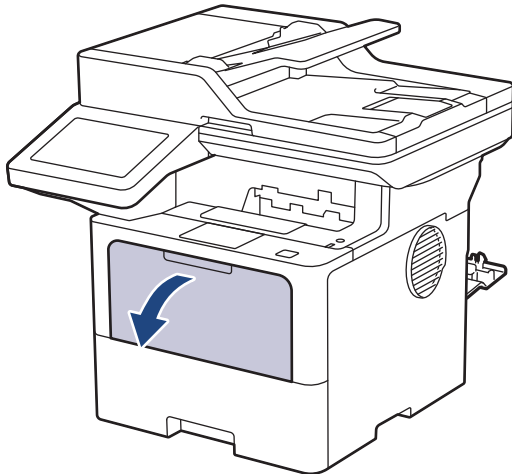

3. Extend the MP tray support.

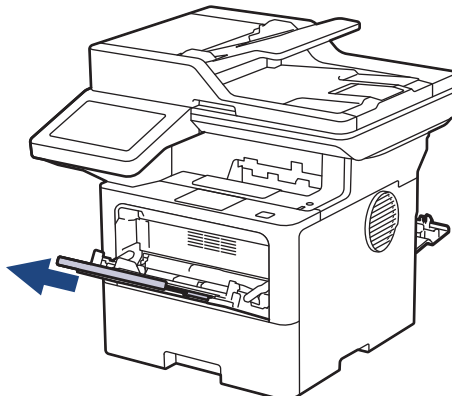

-
4. Slide the MP tray paper guides to fit the width of the envelopes that you are using.

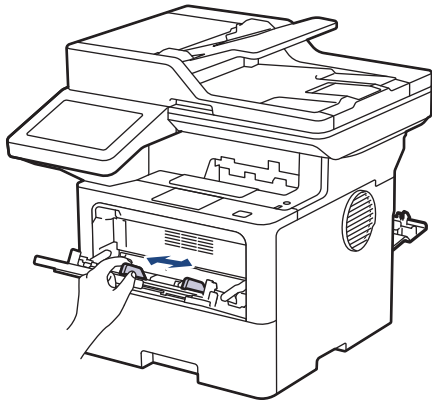

5. Load envelopes with the printing surface *face up* in the MP tray.

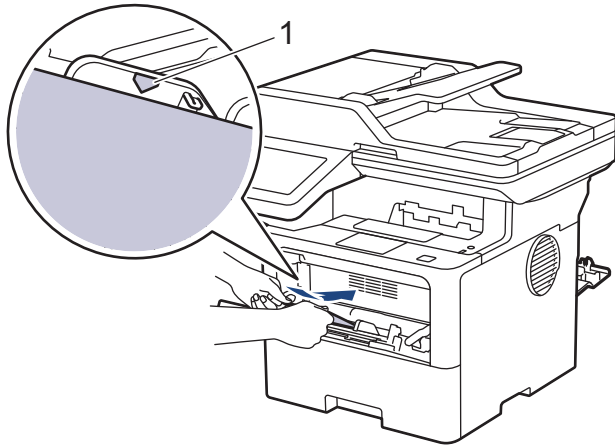

Load the envelopes in the MP tray with the printing surface face up. Make sure the envelopes are below the maximum paper mark (1).

6. Change your print preferences in the Print dialog box.

Settings	Options for Envelopes
Paper Size	Com-10 DL C5 Monarch
Media Type	Envelopes Env. Thick Env. Thin

7. Send your print job to the machine.
8. When finished, close the back cover (the face up output tray) until it locks in the closed position.



Related Information



- [Load and Print Using the Multi-purpose Tray \(MP Tray\)](#)
-

Paper Settings

- [Change the Paper Size and Paper Type](#)
- [Select the Paper Tray For Printing](#)
- [Change the Check Paper Setting](#)

Change the Paper Size and Paper Type

When you change the size and type of paper you load in the tray, you must also change the Paper Size and Paper Type settings on the LCD.

1. Press  [Settings] > [All Settings] > [General Setup] > [Tray Setting] > [Paper Type].
2. Press the option you want.
3. Swipe up or down or press ▲ or ▼ to display the paper type options, and then press the option you want.
4. Press .
5. Press [Paper Size].
6. Press the option you want.
7. Swipe up or down or press ▲ or ▼ to display the paper size options, and then press the option you want.
8. Press .



Related Information



- [Paper Settings](#)

Select the Paper Tray For Printing

Change the machine's default paper tray for printing copies, received faxes, and print jobs from your computer.



DCP models do not support the fax feature.

1. Press  [Settings] > [All Settings] > [General Setup] > [Tray Setting].
2. Swipe up or down or press ▲ or ▼ to display the [Tray Use: Copy], [Tray Use: Fax], or [Tray Use: Print] option, and then press the option you want.
3. Swipe up or down or press ▲ or ▼ to display the option you want, and then press it. For example, when you select the [MP>T1] option, the machine pulls paper from the MP tray until it is empty, and then from Tray 1.
4. Press .



- When you make a copy using the ADF and give priority to multiple trays, the machine looks for the tray with the most suitable paper and pulls paper from that tray.
- When you make a copy using the scanner glass, your document is copied from the higher priority tray even if more suitable paper is in another paper tray.
- (For models with facsimile function) Use the following sizes of paper for printing faxes: Letter, A4, Legal, Folio, Mexico Legal, or India Legal. When an appropriate size is not in any of the trays, the machine stores received faxes and [Size Mismatch] appears on the touchscreen.
- (For models with facsimile function) If the tray is out of paper and received faxes are in the machine's memory, [No Paper] appears on the touchscreen. Load paper in the empty tray.





Related Information

- [Paper Settings](#)

Change the Check Paper Setting

When the Check Paper setting is set to On and you pull the paper tray out of the machine, or load paper in the MP tray, a message appears on the LCD asking if you want to change the paper size and paper type.

The default setting is On.

1. Press  [Settings] > [All Settings] > [General Setup] > [Tray Setting] > [Check Paper].
2. Press [On] or [Off].
3. Press .



Related Information

- [Paper Settings](#)
-

Recommended Print Media

To get the best print quality, we recommend using the paper listed in the table.

Paper Type	Item
Plain Paper	APP Blue Flag Ship 70 g/m ² APP Gold Flag Ship 80 g/m ² Advanced Agro Double A 80 g/m ²



Related Information

- [Paper Handling](#)

Load Documents

You can send a fax, make copies, and scan from the Automatic Document Feeder (ADF) and from the scanner glass.

- [Load Documents in the Automatic Document Feeder \(ADF\)](#)
- [Load Documents on the Scanner Glass](#)

Load Documents in the Automatic Document Feeder (ADF)

Use the ADF when copying or scanning multi page, standard-sized documents.

- The ADF can hold the following sheets and feed each sheet individually:
(DCP-L5518DN/MFC-L5718DN/MFC-L5728DW)
Up to 50 sheets
- Use standard 80 g/m² paper.
- Make sure documents with correction fluid or written in ink are completely dry.

IMPORTANT

- DO NOT leave thick documents on the scanner glass. If you do this, the ADF may jam.
- DO NOT use paper that is curled, wrinkled, folded, ripped, stapled, paper-clipped, glued together, or taped.
- DO NOT use cardboard, newspaper, or fabric.
- To avoid damaging your machine while using the ADF, DO NOT pull on the document while it is feeding.

Supported Document Sizes

Length:	147.3 to 355.6 mm
Width:	105 to 215.9 mm
Weight:	64 to 90 g/m ²

1. Unfold the ADF document output support flap.

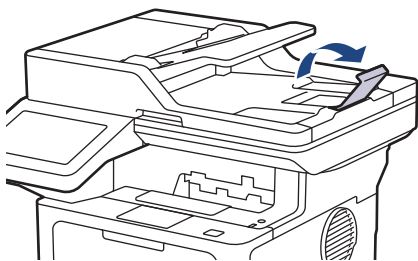

2. Fan the pages well.
3. Stagger the pages of your document and load it into the ADF *face up* and *top edge first*, as shown in the illustration.

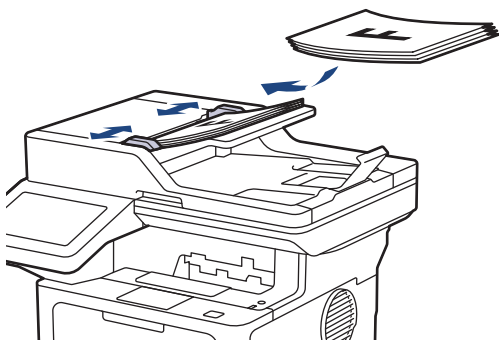

4. Adjust the paper guides to fit the width of your document.

✓ Related Information

- [Load Documents](#)

Load Documents on the Scanner Glass

Use the scanner glass to fax, copy, or scan one page at a time.

Supported Document Sizes

Length:	Up to 300 mm
Width:	Up to 216 mm
Weight:	Up to 2kg



To use the scanner glass, the ADF must be empty.

1. Lift the document cover.
2. Place the document on the scanner glass *face down*.

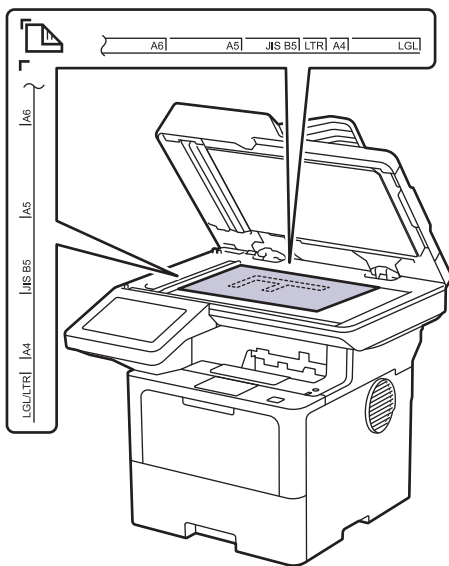

3. Place the corner of the page in the upper left corner of the scanner glass.

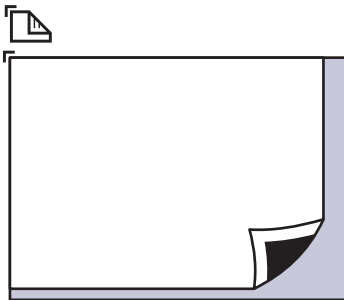

4. Close the document cover.
If the document is a book or is thick, gently press on the document cover.



Related Information

- [Load Documents](#)

Unscannable and Unprintable Areas

The measurements in the table below show the maximum unscannable and unprintable areas from the edges of the most commonly-used paper sizes. These measurements may vary depending on the paper size or settings in the application you are using.

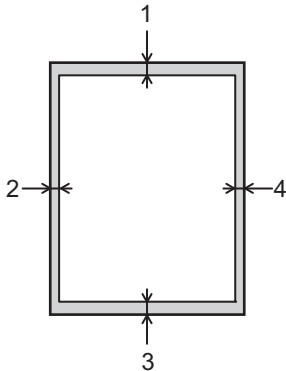

Do not attempt to scan, copy, or print in these areas. Any content included in such areas will not be reflected in the output.

Usage	Document Size	Top (1) Bottom (3)	Left (2) Right (4)
Fax (Sending)	Letter, Legal	3.0 mm	4.0 mm
	A4	3.0 mm	(ADF) 1.0 mm (Scanner Glass) 3.0 mm
Copy ¹	Letter, Legal	4.0 mm	4.0 mm
	A4	4.0 mm	3.0 mm
Scan	Letter	(ADF) 3.0 mm (Scanner Glass) 3.0 mm	(ADF) 3.0 mm (Scanner Glass) 3.0 mm
	A4	(ADF) 3.0 mm (Scanner Glass) 3.0 mm	(ADF) 3.0 mm (Scanner Glass) 3.0 mm
	Legal	(ADF) 3.0 mm (Scanner Glass) 3.0 mm	(ADF) 3.0 mm (Scanner Glass) 3.0 mm
Print	Letter, Legal	4.2 mm	4.2 mm
	A4	4.2 mm	4.2 mm

¹ A 1 in 1 copy and 100% document size copy



Related Information

- [Paper Handling](#)

Using Special Paper

Always test paper samples before purchasing them to ensure desirable performance.

- DO NOT use inkjet paper; it may cause a paper jam or damage your machine.
- If you use bond paper, paper with a rough surface, or paper that is wrinkled or creased, the paper may exhibit degraded performance.

Store paper in its original packaging and keep it sealed. Keep the paper flat and away from moisture, direct sunlight, and heat.

IMPORTANT

Some types of paper may not perform well or may cause damage to your machine.

DO NOT use paper:

- that is highly textured
- that is extremely smooth or shiny
- that is curled or warped
- that is coated or has a chemical finish
- that is damaged, creased, or folded
- that exceeds the recommended weight specification in this guide
- with tabs and staples
- with letterhead using low temperature dyes or thermography
- that is multipart or carbonless
- that is designed for inkjet printing

If you use any of the types of paper listed above, they may damage your machine. This damage is not covered under any Brother warranty or service agreement.



Related Information

- [Paper Handling](#)

Print

- [Print from Your Computer \(Windows\)](#)
- [Print from Your Computer \(Mac\)](#)
- [Print Data Directly from a USB Flash Drive](#)
- [Print Duplicate Copies](#)
- [Change Print Settings Using the Control Panel](#)
- [Cancel a Print Job](#)
- [Test Print](#)

Print from Your Computer (Windows)

- [Print a Document \(Windows\)](#)
- [Print Settings \(Windows\)](#)
- [Secure Print \(Windows\)](#)
- [Change the Default Print Settings \(Windows\)](#)
- [Print a Document Using the BR-Script3 Printer Driver \(PostScript® 3™ Language Emulation\) \(Windows\)](#)
- [Monitor the Status of the Machine from Your Computer \(Windows\)](#)

Print a Document (Windows)

1. Select the print command in your application.
2. Select your model's name, and then click the printing properties or preferences button.

The printer driver window appears.

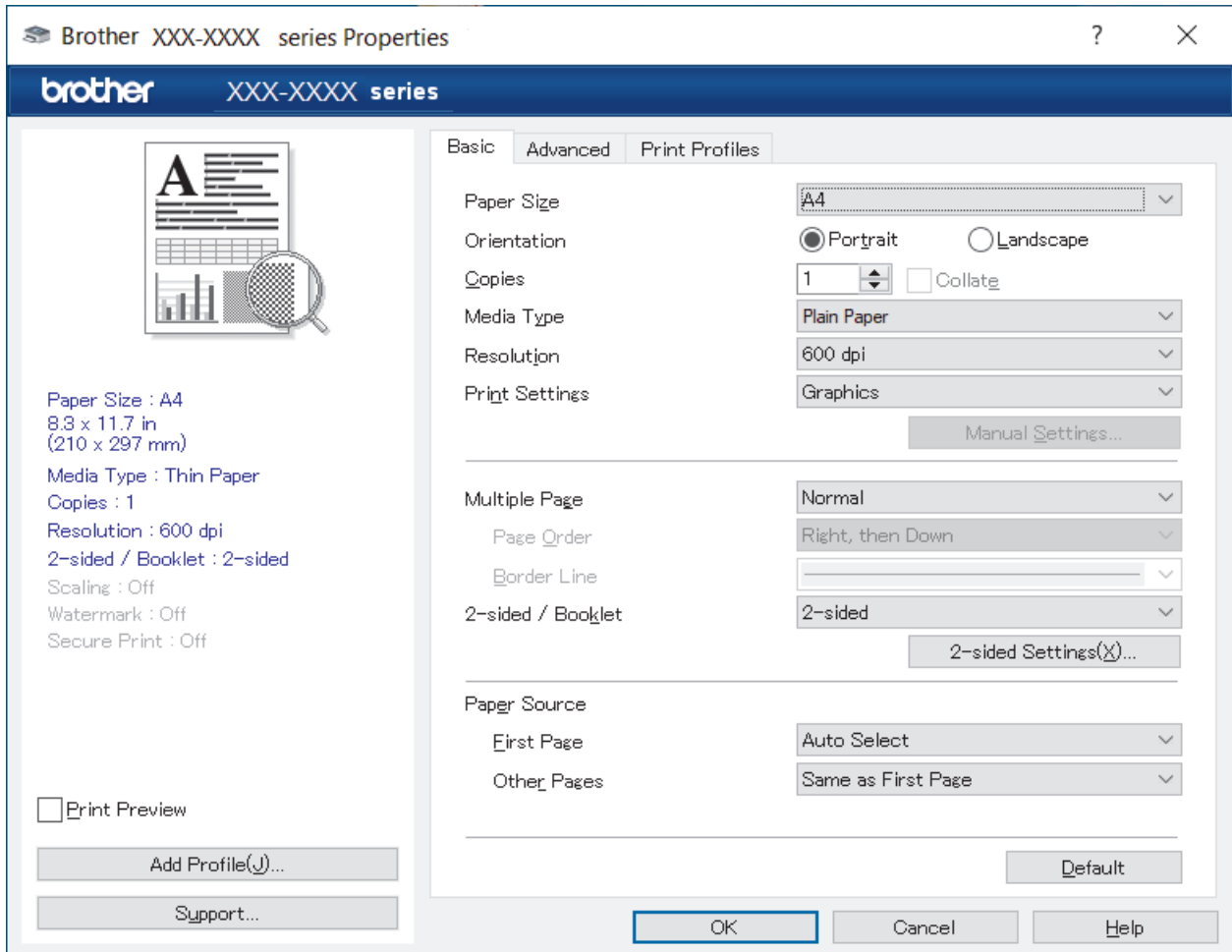

3. Make sure you have loaded the correct size paper in the paper tray.
4. Click the **Paper Size** drop-down list, and then select your paper size.
5. In the **Orientation** field, select the **Portrait** or **Landscape** option to set the orientation of your printout.



If your application contains a similar setting, we recommend that you set the orientation using the application.

6. Type the number of copies (1-999) you want in the **Copies** field.
7. Click the **Media Type** drop-down list, and then select the type of paper you are using.
8. To print multiple pages on a single sheet of paper or print one page of your document on multiple sheets, click the **Multiple Page** drop-down list, and then select your options.
9. Change other printer settings, if needed.
10. Click **OK**.
11. Complete your print operation.



Related Information

- [Print from Your Computer \(Windows\)](#)

Related Topics:

- [Print Settings \(Windows\)](#)
-

Print Settings (Windows)

- >> Basic Tab
- >> Advanced Tab

Basic Tab

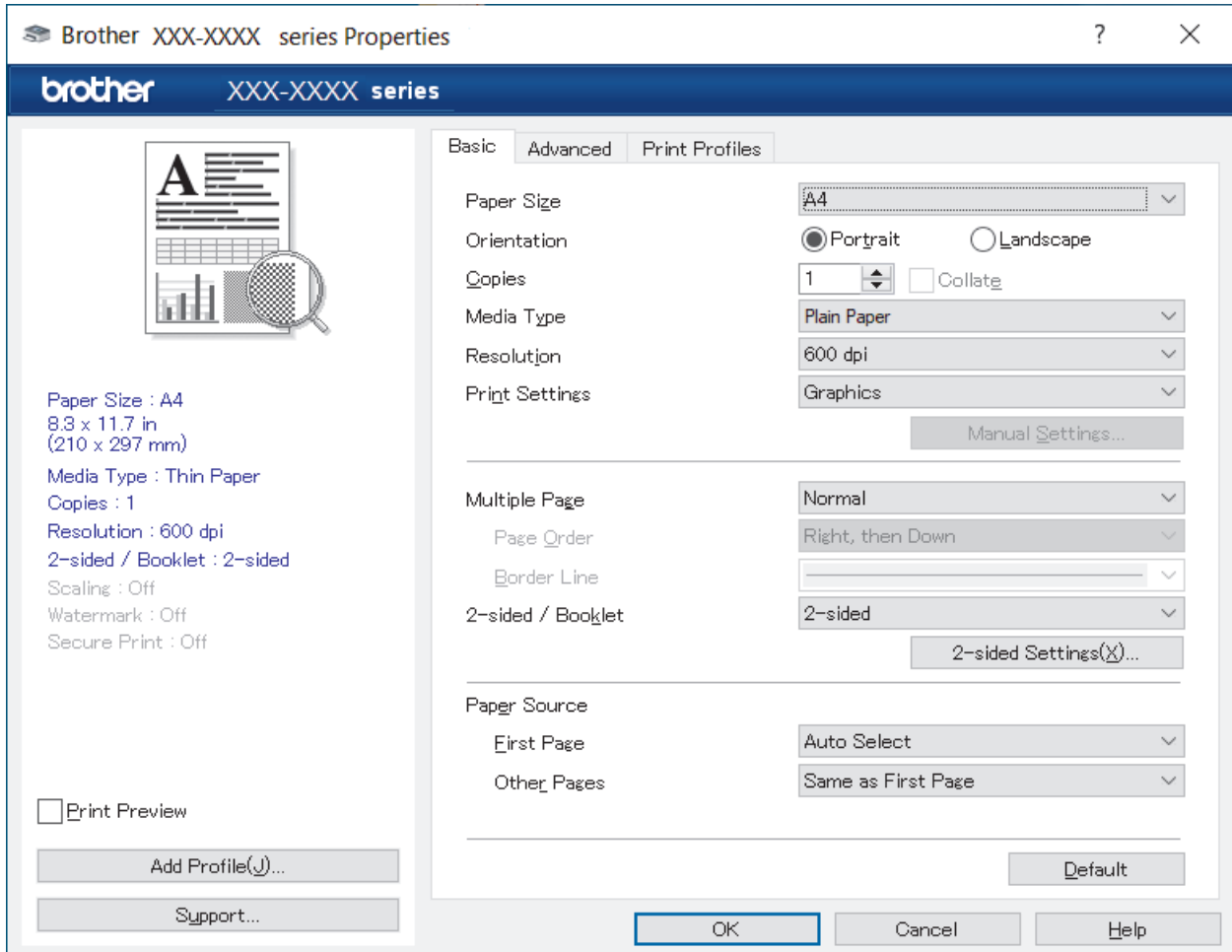

1. Paper Size

Select the paper size you want to use. You can either choose from standard paper sizes or create a custom paper size.

2. Orientation

Select the orientation (portrait or landscape) of your printout.

If your application contains a similar setting, we recommend that you set the orientation using the application.

3. Copies

Type the number of copies (1-999) that you want to print in this field.

Collate

Select this option to print sets of multi-page documents in the original page order. When this option is selected, one complete copy of your document will print, and then reprint according to the number of copies you choose. If this option is not selected, then each page will print according to the number of copies chosen before the next page of the document is printed.

4. Media Type

Select the media type you want to use. To achieve the best print results, the machine automatically adjusts its print settings according to the selected media type.

5. Resolution

Select the print resolution. As print resolution and speed are related, the higher the resolution, the longer it will take to print the document.

6. Print Settings

Select the type of document you want to print.

Manual Settings...

Specify additional settings such as brightness, contrast, and other settings.

Graphics

Use Printer Halftone

Select this option to use the printer driver to express halftones.

Brightness

Adjust the brightness.

Contrast

Adjust the contrast.

Graphics Quality

Select either Graphics or Text for the best print quality, based on the type of document you are printing.

Improve Grey Printing

Select this option to improve the image quality of shaded areas.

Improve Pattern Printing

Select this option to improve the pattern printing if printed fills and patterns are different from the fills and patterns you see on your computer screen.

Improve Thin Line

Select this option to improve the image quality of thin lines.

Use System Halftone

Select this option to use Windows to express halftones.

TrueType Mode

Mode

Select how the fonts are processed for printing.

7. Multiple Page

Select this option to print multiple pages on a single sheet of paper, or print one page of your document on multiple sheets.

Page Order

Select the page order when printing multiple pages on a single sheet of paper.

Border Line

Select the type of border to use when printing multiple pages on a single sheet of paper.

8. 2-sided / Booklet

Select this option to print on both sides of the paper, or print a document in booklet format using 2-sided printing.

2-sided Settings

Click this button to select the type of 2-sided binding. Four types of 2-sided bindings are available for each orientation.

9. Paper Source

Select the paper source setting according to your print conditions or purpose.

First Page

Select the paper source to use for printing the first page.

Other Pages

Select the paper source to use for printing the second and subsequent pages.

Advanced Tab

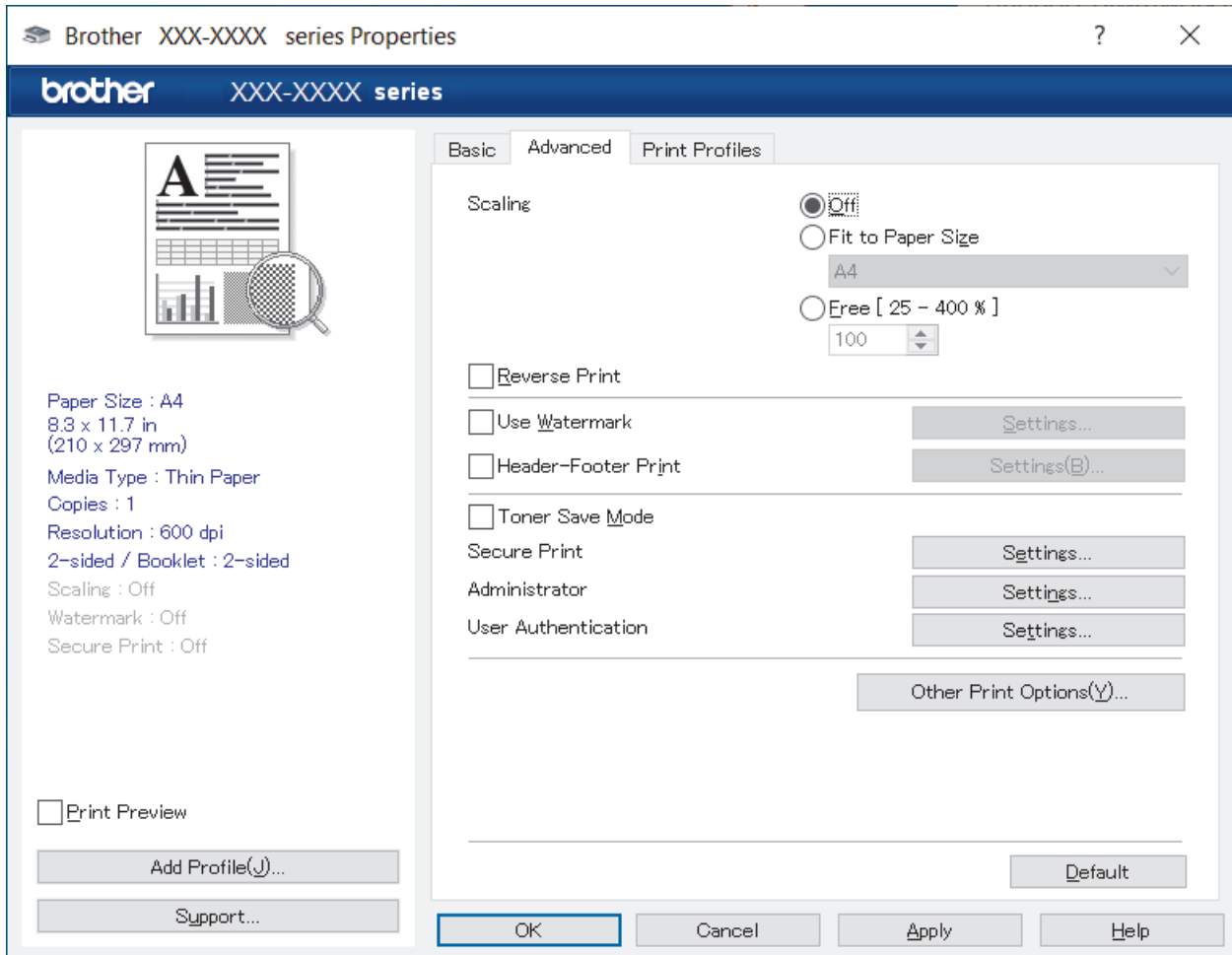

1. Scaling

Select these options to enlarge or reduce the size of the pages in your document.

Fit to Paper Size

Select this option to enlarge or reduce the document pages to fit a specified paper size. When you select this option, select the paper size you want from the drop-down list.

Free [25 - 400%]

Select this option to enlarge or reduce the document pages manually. When you select this option, type a value into the field.

2. Reverse Print

Select this option to rotate the printed image 180 degrees.

3. Use Watermark

Select this option to print a logo or text on your document as a watermark. Select one of the preset watermarks, add a new watermark, or use an image file you have created.

4. Header-Footer Print

Select this option to print the date, time, and login user name on the document.

5. Toner Save Mode

Select this feature to use less toner to print documents; printouts appear lighter, but are still legible.

6. Secure Print (available for certain models)

This feature ensures that confidential or sensitive documents are not printed out until you enter a password on the machine's control panel.

7. Administrator

This feature allows you to change the administrator password and restrict various printing functions.

8. User Authentication (available for certain models)

This feature allows you to confirm the restrictions for each user.

9. Other Print Options

Sleep Time

Select this option to set the machine to enter sleep mode immediately after printing.

Macro (available for certain models)

Select this feature to print an electronic form (macro), which you have stored in your machine's memory, as an overlay on the print job.

Density Adjustment

Specify the print density.

Improve Print Output

Select this option to reduce the amount of paper curling and improve the toner fixing.

Skip Blank Page

Select this option to allow the printer driver to automatically detect blank pages and exclude them from printing.

Print Text in Black

Select this option when you want to print colour text in black.

Print Archive

Select this option to save the print data as a PDF file to your computer.

Eco settings

Select this option to reduce printing noise.



Related Information

- [Print from Your Computer \(Windows\)](#)

Related Topics:

- [Print a Document \(Windows\)](#)
-

Secure Print (Windows)

Use Secure Print to ensure that confidential or sensitive documents do not print until you enter a password on the machine's control panel.

The secure data is deleted from the machine when you turn the machine off.

1. Select the print command in your application.
2. Select your model's name, and then click the printer's properties or preferences button.
The printer driver window appears.
3. Click the **Advanced** tab.
4. Click the **Settings** button in the **Secure Print** field.
5. Select the **Secure Print** checkbox.
6. Type your four-digit password in the **Password** field.
7. Type the user name and job name in the **User Name** and **Job Name** fields, if needed.
8. Click **OK** to close the **Secure Print Settings** window.
9. Click **OK**.
10. Complete your print operation.
11. On the machine's control panel, swipe left or right or press ◀ or ▶ to display the [Secure Print] option, and then press it.
12. Swipe up or down or press ▲ or ▼ to display user names, and then press your user name.
13. Enter your four-digit password, and then press [OK].
14. Swipe up or down or press ▲ or ▼ to display the print job, and then press it.
15. Enter the number of copies you want, and then press [OK].
16. Press [Start].

The secured data will be cleared from the machine's memory after printing.





Related Information

- [Print from Your Computer \(Windows\)](#)

Change the Default Print Settings (Windows)

When you change an application's print settings, the changes apply only to documents printed with that application. To change print settings for all Windows applications, you must configure the printer driver properties.

1. Do one of the following:
 - For Windows 11
Click  > **All apps** > **Windows Tools** > **Control Panel**. In the **Hardware and Sound** group, click **View devices and printers**.
 - For Windows 10, Windows Server 2016, Windows Server 2019, and Windows Server 2022
Click  > **Windows System** > **Control Panel**. In the **Hardware and Sound (Hardware)** group, click **View devices and printers**.
 - For Windows Server 2012 R2
Click **Control Panel** on the **Start** screen. In the **Hardware** group, click **View devices and printers**.
 - For Windows Server 2012
Move your mouse to the lower right corner of your desktop. When the menu bar appears, click **Settings**, and then click **Control Panel**. In the **Hardware** group, click **View devices and printers**.
2. Right-click your model's icon, and then select **Printer properties**. (If the printer driver options appear, select your printer driver.)

The printer properties dialog box appears.
3. Click the **General** tab, and then click the **Printing Preferences...** or **Preferences...** button.

The printer driver dialog box appears.

 - To configure the tray settings, click the **Device Settings** tab (available for certain models).
 - To change the printer port, click the **Ports** tab.

4. Select the print settings you want to use as default for all of your Windows programs.
5. Click **OK**.
6. Close the printer properties dialog box.





Related Information

- [Print from Your Computer \(Windows\)](#)
 - [Configure the Optional Tray Settings \(Windows\)](#)

Configure the Optional Tray Settings (Windows)

Access your machine's Properties to auto-detect your machine's Optional Tray and check the machine's serial number.

The printer driver automatically detects the Optional Tray during the driver installation. If you added the Optional Tray after the driver installation, follow these steps:

1. Do one of the following:
 - For Windows 11
Click  > **All apps** > **Windows Tools** > **Control Panel**. In the **Hardware and Sound** group, click **View devices and printers**.
 - For Windows 10, Windows Server 2016, Windows Server 2019, and Windows Server 2022
Click  > **Windows System** > **Control Panel**. In the **Hardware and Sound (Hardware)** group, click **View devices and printers**.
 - For Windows Server 2012 R2
Click **Control Panel** on the **Start** screen. In the **Hardware** group, click **View devices and printers**.
 - For Windows Server 2012
Move your mouse to the lower right corner of your desktop. When the menu bar appears, click **Settings**, and then click **Control Panel**. In the **Hardware** group, click **View devices and printers**.
2. Right-click your model's icon, and then select **Printer properties**. (If the printer driver options appear, select your printer driver.)
The printer properties dialog box appears.
3. Click the **Device Settings** tab.
4. Click the **Auto Detect** button.
The Optional Tray and the machine's serial number are automatically detected.
5. Click the **Apply** button.
6. Close the printer properties dialog box.

The **Auto Detect** function is not available under the following machine conditions:

- The machine is turned off.
- The machine is shared via a Print Server.
- The machine and your computer are not connected.

Related Information

- [Change the Default Print Settings \(Windows\)](#)

Print a Document Using the BR-Script3 Printer Driver (PostScript® 3™ Language Emulation) (Windows)

The BR-Script3 printer driver lets you print PostScript® data more clearly.

Go to your model's **Downloads** page at support.brother.com/downloads to install the PS driver (BR-Script3 printer driver).

1. Select the print command in your application.
2. Select your model with **BR-Script3** in the name, and then click the printing properties or preferences button.

The printer driver window appears.

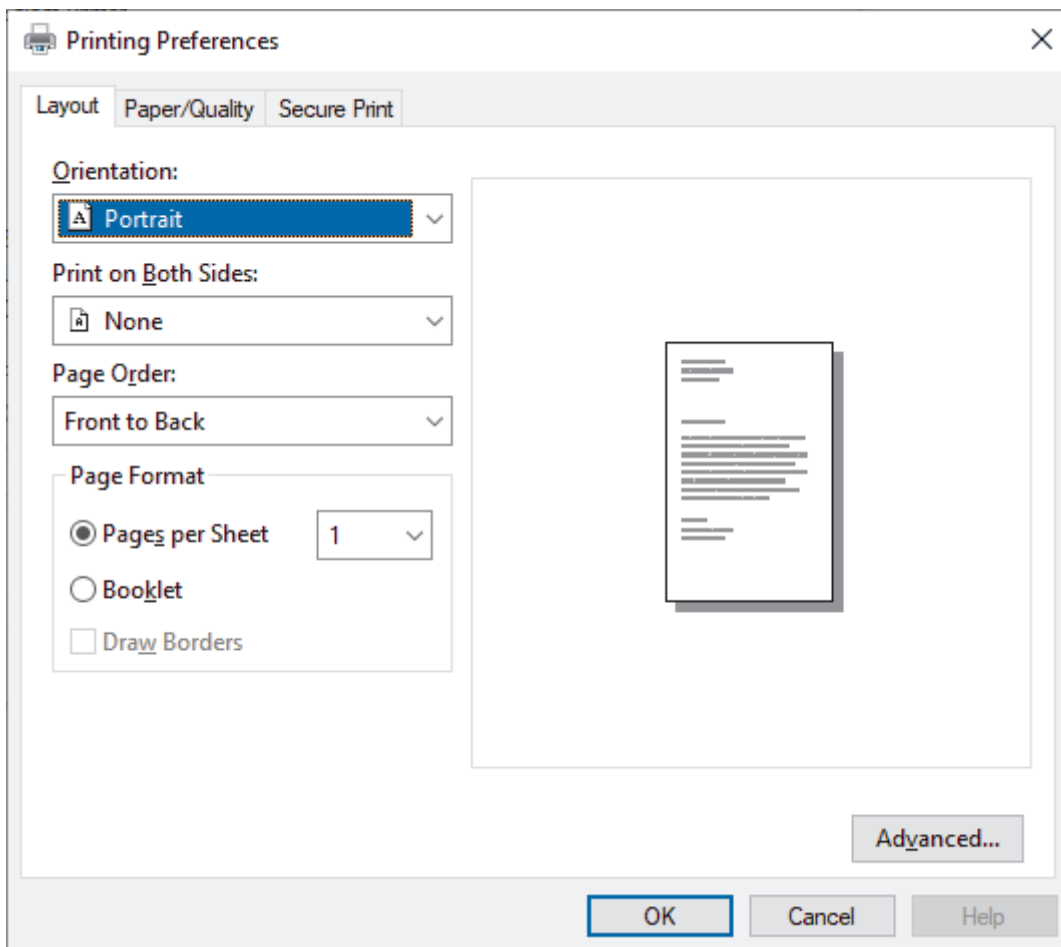

3. Click the **Layout**, **Paper/Quality**, or **Secure Print** tab to change basic print settings. (available for certain models)

Click the **Layout** or **Paper/Quality** tab, and then click the **Advanced...** button to change advanced print settings. Click **OK**.

4. Click **OK**.
5. Complete your print operation.



✓ Related Information

- [Print from Your Computer \(Windows\)](#)

Monitor the Status of the Machine from Your Computer (Windows)

The Status Monitor is a configurable software tool for monitoring the status of one or more machines, allowing you to get immediate notification of errors.

Do one of the following:

- Double-click the  icon in the task tray.
- Launch  (**Brother Utilities**), and then click the drop-down list and select your model's name (if not already selected). Click **Tools** in the left navigation bar, and then click **Status Monitor**.

Troubleshooting

Click the **Troubleshooting** button to access the support website.

Visit the Genuine Supplies website

Click the **Visit the Genuine Supplies website** button for more information on Brother genuine supplies.

Related Information

- [Print from Your Computer \(Windows\)](#)

Related Topics:

- [Printing Problems](#)
-

Print from Your Computer (Mac)

- [Print Using AirPrint](#)

Print Using AirPrint

- [Print from iPad, iPhone, or iPod touch](#)
- [Print Using AirPrint \(macOS\)](#)

Print Data Directly from a USB Flash Drive

You can print photos directly from a digital camera or a USB flash drive. Supported file types are PDF, JPEG, TIFF, XPS, and PRN.

- [Compatible USB Flash Drives](#)
- [Print Data Directly from a USB Flash Drive or Digital Camera Supporting Mass Storage](#)
- [Create a PRN File for Direct Printing \(Windows\)](#)

Compatible USB Flash Drives

IMPORTANT

The USB direct interface supports only USB flash drives and digital cameras that use the USB mass storage standard. Other USB devices are not supported.

Compatible USB Flash Drives	
USB Class	USB Mass Storage Class
USB Mass Storage Sub Class	SCSI or SFF-8070i
Transfer Protocol	Bulk transfer Only
Format ¹	FAT12/FAT16/FAT32/exFAT
Sector Size	Max. 4096 Byte
Encryption	Encrypted devices are not supported.

¹ NTFS format is not supported.



Related Information

- [Print Data Directly from a USB Flash Drive](#)

Print Data Directly from a USB Flash Drive or Digital Camera Supporting Mass Storage

- Make sure your digital camera is turned on.
- Your digital camera must be switched from PictBridge mode to Mass Storage mode.

IMPORTANT

To prevent damage to your machine, DO NOT connect any device other than a digital camera or USB flash drive to the USB direct interface.

USB Port Location (Front View)

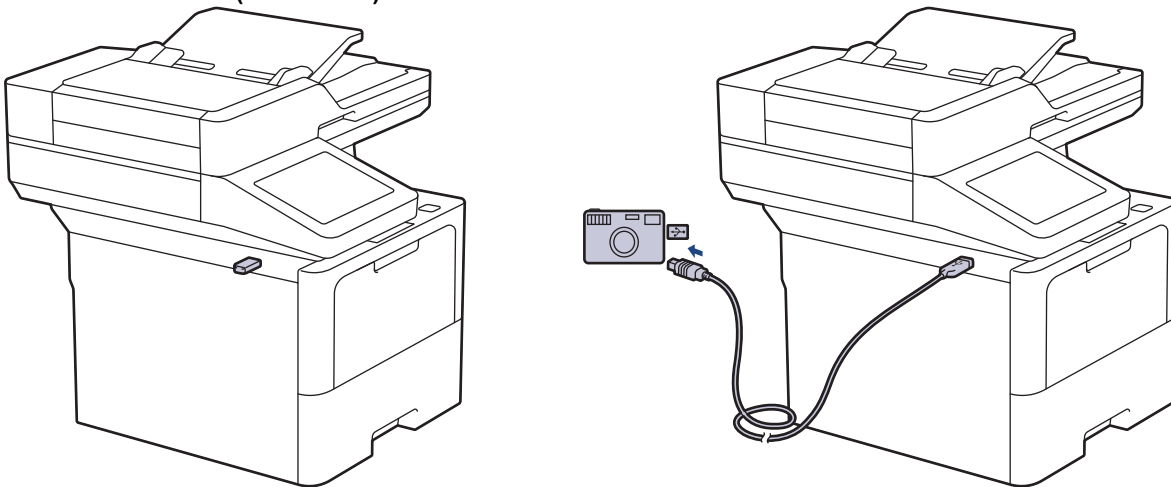

1. Connect your USB flash drive or digital camera to the USB direct interface. The touchscreen will automatically display the USB menu to confirm that the USB flash drive or digital camera is correctly connected.



- If an error occurs, the USB menu will not appear on the touchscreen.
- When the machine is in Deep Sleep mode, the touchscreen does not display any information even if you connect a USB flash drive to the USB direct interface. Press the touchscreen to wake up the machine.
- If your machine's Secure Function Lock is On, you may not be able to print from a USB flash drive or digital camera.

2. Press [Direct Print].
3. Swipe up or down, or press ▲ or ▼ to display the file you want to print, and then select the file.



To print an index of the files stored on the USB flash drive or digital camera, press [Index Print] on the touchscreen. Press [Yes] to print the data.

4. Do one of the following:
 - To change the settings, press [Print Settings]. Go to the next step.
 - If you want to use the default settings, enter the number of copies, and then press [Start].
5. Select the print settings you want to change:
 - [Print Quality]
 - [Tray Use]
 - [Paper Type]

-
- [Paper Size]
 - [Multiple Page]
 - [Orientation]
 - [2-sided]
 - [Collate]
 - [PDF Print Options]
 - [PDF Fit to Page]



Depending on the file type, some of these settings may not appear.

6. Press [OK].
7. Enter the number of copies you want.
8. Press [Start] to print the data.
9. Press .

IMPORTANT

DO NOT remove the USB flash drive or digital camera from the USB direct interface until the machine has finished printing.



Related Information

- [Print Data Directly from a USB Flash Drive](#)
-

Create a PRN File for Direct Printing (Windows)

These instructions may vary depending on your print application and operating system.

1. Select the print command in your application.
2. Select your model, and then select the print to file option.
3. Complete your print operation.
4. Enter the required information to save the file.



If the computer prompts you to enter a file name only, you can also specify the folder where you want to save the file by typing the directory name (for example: C:\Temp\FileName.prn).

If a USB flash drive is connected to your computer, you can save the file directly to the USB flash drive.



Related Information

- [Print Data Directly from a USB Flash Drive](#)
-

Print Duplicate Copies

Use the Carbon Copy function to make multiple copies of the same print data, as if printing on carbon paper. Send the data to individual paper trays that you loaded with different paper types or colours.

For example, you may want to set the machine to send your print data to Tray 1, which you have pre-loaded with blue coloured paper, and then reprint the data in a certain location on the page from the MP Tray, which you have loaded with yellow coloured paper that already contains text.

If you load blue paper in Tray 1 and yellow paper in the MP tray, the printer will automatically feed paper for Sheet 1 from Tray 1 and Sheet 2 from the MP Tray.

If you enable the Carbon Copy function, the machine will always make copies automatically.



Windows

The Carbon Copy function also allows you to select a different printing macro/stream for each page.

1. Press  [Settings] > [All Settings] > [Printer] > [Carbon Menu] > [Carbon Copy] > [On].
2. Swipe up or down or press ▲ or ▼ to display the [Copies] option, and then press the [Copies] option.
3. Enter the number of copies you want, and then press [OK].
4. Swipe up or down or press ▲ or ▼ to display the [Copy1 Tray] option, and then press the [Copy1 Tray] option.
5. Swipe up or down or press ▲ or ▼ to display the paper tray you want to configure for the [Copy1 Macro] option, and then press to select the paper tray.



Windows

- a. Swipe up or down or press ▲ or ▼ to display the [Copy1 Macro] option, and then press it.
 - b. Swipe up or down or press ▲ or ▼ to display the ID number of the macro/stream you want to use, and then press it.
6. Repeat these steps until you have selected all the tray settings for each copy.
 7. Press .
 8. Send your print job to the machine.





Related Information

- [Print](#)

Change Print Settings Using the Control Panel

Select the type of document you want to print.

1. Press  [Settings] > [All Settings] > [Printer] > [Print Settings].
2. Press [Text] or [Graphics].
3. Press .



Related Information

- [Print](#)
-

Cancel a Print Job

Press .



To cancel multiple print jobs, press and hold  for about four seconds.

Related Information



- [Print](#)

Related Topics:

- [Printing Problems](#)
-

Test Print

If there are problems with print quality, follow these instructions to do a test print:

1. Press  [Settings] > [All Settings] > [Printer] > [Print Options] > [Test Print].
2. Press [Yes].
3. Press .



Related Information

- [Print](#)

Related Topics:

- [Improve the Print Quality](#)
-

Scan

- [Scan Using the Scan Button on Your Machine](#)
- [Scan from Your Computer \(Windows\)](#)
- [Scan from Your Computer \(Mac\)](#)
- [Configure Scan Settings Using Web Based Management](#)

Scan Using the Scan Button on Your Machine

- [Scan Photos and Graphics](#)
- [Save Scanned Data to a Folder as a PDF File](#)
- [Save Scanned Data to a USB Flash Drive](#)
- [Scan to an Editable Text File \(OCR\)](#)
- [Save Scanned Data as an Email Attachment](#)
- [Send Scanned Data to an Email Recipient](#)
- [Scan to FTP](#)
- [Scan to SSH Server \(SFTP\)](#)
- [Scan to Network \(Windows\)](#)
- [Scan to SharePoint](#)
- [Use the Web Services Protocol for Network Scanning \(Windows 10 and Windows 11\)](#)
- [Change the Scan Button Settings from Brother iPrint&Scan](#)
- [Configure Certificates for Signed PDFs](#)
- [Disable Scanning from Your Computer](#)

Scan Photos and Graphics

Send scanned photos or graphics directly to your computer.

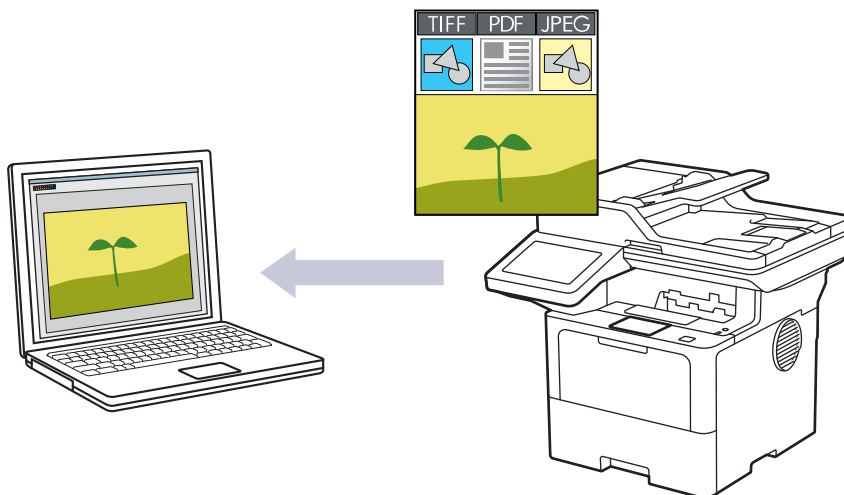

Use the Scan button on the machine to make temporary changes to the scan settings. To make permanent changes, use Brother iPrint&Scan.

1. Load your document.
2. Press [Scan] > [to PC] > [to Image].
3. If the machine is connected over the network, select the computer name where you want to send data.



If the LCD prompts you to enter a PIN for the computer, enter the four-digit PIN on the LCD, and then press [OK].

4. To change the settings, press  [Options], and then select the scan settings you want to change. If you use the default settings, skip this step.
 - [2-sided Scan] (MFC-L5718DN/MFC-L5728DW)
 - [Scan Settings]
 - [Colour Setting]
 - [Resolution]
 - [File Type]
 - [Document Size]
 - [Brightness]
 - [Contrast]
 - (available only for the [Colour] and [Grey] options)
 - [Auto Des skew]
 - [Skip Blank Page]
 - [Skip Blank Page Sensitivity]
 - [Remove Background Colour]
 - (available only for the [Colour] and [Grey] options)
 - [Margin Settings] (available only for certain models)
 - [B&W TIFF Compress]



- To change scan settings, a computer with the Brother iPrint&Scan software installed must be connected to your machine.
 - If your machine displays the [OK] button, press [OK].
 - To save the settings as a shortcut, press [Save as Shortcut].
-

5. Press [Start].

The machine starts scanning. If using the machine's scanner glass, follow the touchscreen instructions to complete the scanning job.



Related Information

- [Scan Using the Scan Button on Your Machine](#)
-

Save Scanned Data to a Folder as a PDF File

Scan documents and save them to a folder on your computer as PDF files.

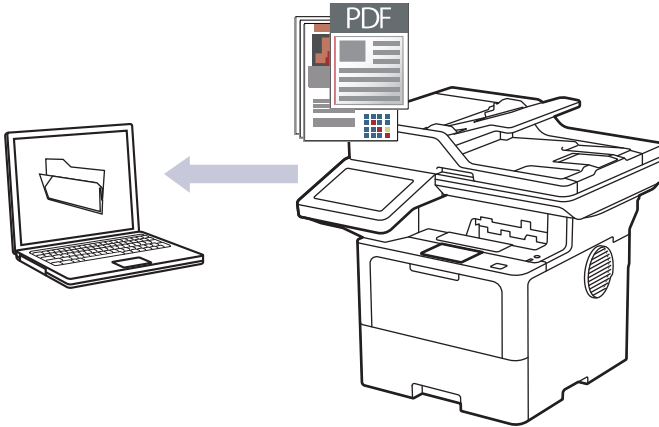

Use the Scan button on the machine to make temporary changes to the scan settings. To make permanent changes, use Brother iPrint&Scan.

1. Load your document.
2. Press [Scan] > [to PC] > [to File].
3. If the machine is connected over the network, select the computer name where you want to send data.



If the LCD prompts you to enter a PIN for the computer, enter the four-digit PIN on the LCD, and then press [OK].

4. To change the settings, press  [Options], and then select the scan settings you want to change. If you use the default settings, skip this step.
 - [2-sided Scan] (MFC-L5718DN/MFC-L5728DW)
 - [Scan Settings]
 - [Colour Setting]
 - [Resolution]
 - [File Type]
 - [Document Size]
 - [Brightness]
 - [Contrast]
(available only for the [Colour] and [Grey] options)
 - [Auto Deskew]
 - [Skip Blank Page]
 - [Skip Blank Page Sensitivity]
 - [Remove Background Colour]
(available only for the [Colour] and [Grey] options)
 - [Margin Settings] (available only for certain models)
 - [B&W TIFF Compress]



- To change scan settings, a computer with the Brother iPrint&Scan software installed must be connected to your machine.
 - If your machine displays the [OK] button, press [OK].
 - To save the settings as a shortcut, press [Save as Shortcut].
-

5. Press [Start].

The machine starts scanning. If using the machine's scanner glass, follow the touchscreen instructions to complete the scanning job.



Related Information

- [Scan Using the Scan Button on Your Machine](#)
-

Save Scanned Data to a USB Flash Drive

Scan documents directly to a USB flash drive.

1. Load your document.
2. Insert a USB flash drive into your machine.
3. Press [Scan to USB].
4. To change the settings, press  [Options], and then select the scan settings you want to change. If you use the default settings, skip this step.
 - [2-sided Scan] (MFC-L5718DN/MFC-L5728DW)
 - [Colour Setting]
 - [Resolution]
 - [File Type]
 - [Document Size]
 - [Brightness]
 - [Contrast]
(available only for the [Colour] and [Grey] options)
 - [File Name]
 - [File Name Style]
 - [File Size]
(available only for the [Colour] and [Grey] options)
 - [Auto Crop]
 - [Auto Deskew]
 - [Skip Blank Page]
 - [Skip Blank Page Sensitivity]
 - [Remove Background Colour]
(available only for the [Colour] and [Grey] options)
 - [Margin Settings] (available only for certain models)
 - [Document Separation]
 - [B&W TIFF Compress]



- If your machine displays the [OK] button, press [OK].
- To set your own default settings: after making changes to settings, press the [Set New Default] option, and then press [Yes].
- To restore the factory settings: press [Factory Reset], and then press [Yes].
- To save the settings as a shortcut, press [Save as Shortcut].

5. Press [Start].

The machine starts scanning. If using the machine's scanner glass, follow the touchscreen instructions to complete the scanning job.

IMPORTANT

The LCD displays a message while reading the data. DO NOT unplug the power cord or remove the USB flash drive from the machine while it is reading the data. You could lose your data or damage the USB flash drive.



Related Information

- [Scan Using the Scan Button on Your Machine](#)
-

Scan to an Editable Text File (OCR)

Your machine can convert characters in a scanned document to text using the optical character recognition (OCR) technology. You can edit this text using your preferred text-editing application.

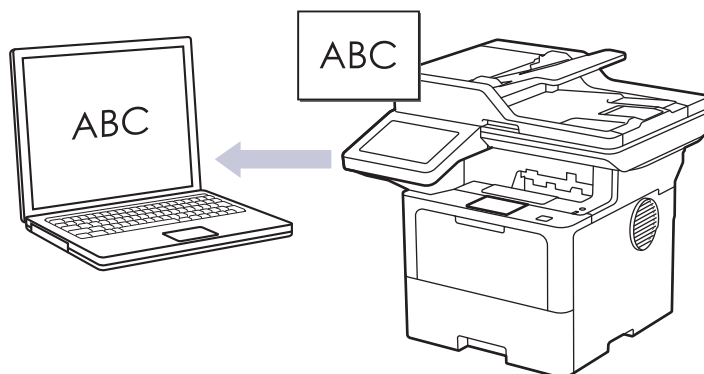

- The Scan to OCR feature is available only for certain languages.
- Use the Scan button on the machine to make temporary changes to the scan settings. To make permanent changes, use Brother iPrint&Scan.

1. Load your document.
2. Press [Scan] > [to PC] > [to OCR].
3. If the machine is connected over the network, select the computer name where you want to send data.



If the LCD prompts you to enter a PIN for the computer, enter the four-digit PIN on the LCD, and then press [OK].

4. To change the settings, press  [Options], and then select the scan settings you want to change. If you use the default settings, skip this step.
 - [2-sided Scan] (MFC-L5718DN/MFC-L5728DW)
 - [Scan Settings]
 - [Colour Setting]
 - [Resolution]
 - [File Type]
 - [Document Size]
 - [Brightness]
 - [Contrast]
 - (available only for the [Colour] and [Grey] options)
 - [Auto Deskew]
 - [Skip Blank Page]
 - [Skip Blank Page Sensitivity]
 - [Remove Background Colour]
 - (available only for the [Colour] and [Grey] options)
 - [Margin Settings] (available only for certain models)



- To change scan settings, a computer with the Brother iPrint&Scan software installed must be connected to your machine.
- If your machine displays the [OK] button, press [OK].
- To save the settings as a shortcut, press [Save as Shortcut].

5. Press [Start].

The machine starts scanning. If using the machine's scanner glass, follow the touchscreen instructions to complete the scanning job.



Related Information

- [Scan Using the Scan Button on Your Machine](#)
-

Save Scanned Data as an Email Attachment

Send the scanned data from your machine to your email application as an attachment.

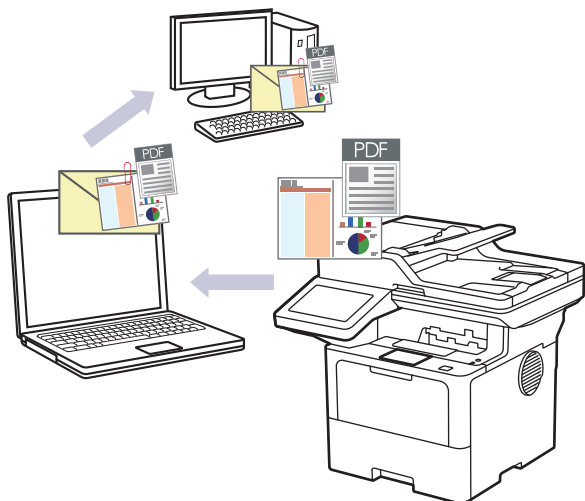

- Use the Scan button on the machine to make temporary changes to the scan settings. To make permanent changes, use Brother iPrint&Scan.
- To use this feature with your machine's Scan button, make sure you select one of these applications in Brother iPrint&Scan:
 - Windows: Microsoft Outlook
 - Mac: Apple MailFor other applications and Webmail services, use the Scan to Image or Scan to File feature to scan a document, and then attach the scanned file to an email message.

1. Load your document.
2. Press [Scan] > [to PC] > [to E-mail].
3. If the machine is connected over the network, select the computer name where you want to send data.



If the LCD prompts you to enter a PIN for the computer, enter the four-digit PIN on the LCD, and then press [OK].

4. To change the settings, press  [Options], and then select the scan settings you want to change. If you use the default settings, skip this step.
 - [2-sided Scan] (MFC-L5718DN/MFC-L5728DW)
 - [Scan Settings]
 - [Colour Setting]
 - [Resolution]
 - [File Type]
 - [Document Size]
 - [Brightness]
 - [Contrast]
 - (available only for the [Colour] and [Grey] options)
 - [Auto Deskew]
 - [Skip Blank Page]
 - [Skip Blank Page Sensitivity]
 - [Remove Background Colour]

(available only for the [Colour] and [Grey] options)

- [Margin Settings] (available only for certain models)
- [B&W TIFF Compress]



- To change scan settings, a computer with the Brother iPrint&Scan software installed must be connected to your machine.
- If your machine displays the [OK] button, press [OK].
- To save the settings as a shortcut, press [Save as Shortcut].

5. Press [Start].

The machine starts scanning. If using the machine's scanner glass, follow the touchscreen instructions to complete the scanning job.



Related Information

- [Scan Using the Scan Button on Your Machine](#)
-

Send Scanned Data to an Email Recipient

Send scanned data directly from your machine to an email recipient without using a computer. This function allows your machine to scan documents and send them to an email address without your machine being connected to a computer. To send the scanned data as an attachment directly to your default email application using the iPrint&Scan software on your computer or the Scan button on your machine, use the "Scan to Email Attachment" function instead.

- To send scanned data to an email recipient, you must configure your machine to communicate with your network and email server, which is used to send and receive emails.
- Configure these items from the machine's control panel or Web Based Management.
- To use the Scan to Email Server function, connect your machine to the network and access an SMTP server. Set up the following SMTP email settings:
 - Server address
 - Port number
 - User name
 - Encryption type (SSL or TLS)
 - Email server certificate (if used)

If you do not know these settings, contact your email service provider or network administrator.

1. Load your document.
2. Press [Scan] > [to E-mail Server].



- If you registered your email address with your user ID, the [to My E-mail] option appears when you log on to the machine using Secure Function Lock, Active Directory Authentication, or LDAP Authentication.
- To send scanned data to your email address, press [to My E-mail]. When your email address appears on the LCD, press [Next].
- To enable this feature in Web Based Management, go to the navigation menu, and then click **Scan > Scan to E-mail Server**. In the **Send to My E-mail** field, select **On**. Click **Submit**.

3. Do one of the following to enter the destination email address:
 - To enter the email address manually, press [Manual], and then enter the email address using the keyboard on the LCD. When finished, press [OK].
 - If the email address is stored in the machine's address book, press [Address Book], and then select the email address.
Press [OK].
4. Confirm the email address, and then press [Next].
5. To change the settings, press  [Options], and then select the scan settings you want to change. If you use the default settings, skip this step.
 - [2-sided Scan] (MFC-L5718DN/MFC-L5728DW)
 - [Colour Setting]
 - [Resolution]
 - [File Type]
 - [Document Size]
 - [Brightness]
 - [Contrast]
(available only for the [Colour] and [Grey] options)
 - [File Name]

-
- [File Name Style]
 - [File Size]
(available only for the [Colour] and [Grey] options)
 - [Auto Deskew]
 - [Skip Blank Page]
 - [Skip Blank Page Sensitivity]
 - [Remove Background Colour]
(available only for the [Colour] and [Grey] options)
 - [Margin Settings] (available only for certain models)
 - [Document Separation]
 - [B&W TIFF Compress]



-
- If your machine displays the [OK] button, press [OK].
 - To set your own default settings: after making changes to settings, press the [Set New Default] option, and then press [Yes].
 - To restore the factory settings: press [Factory Reset], and then press [Yes].
 - To save the settings as a shortcut, press [Save as Shortcut].

(This function may not be available depending on your machine conditions.)

6. Press [Start].

The machine starts scanning. If using the machine's scanner glass, follow the touchscreen instructions to complete the scanning job.



Related Information

- [Scan Using the Scan Button on Your Machine](#)
-

Scan to FTP

Scan documents directly to an FTP server when you need to share the scanned information. For added convenience, configure different profiles to save your favourite Scan to FTP destinations.

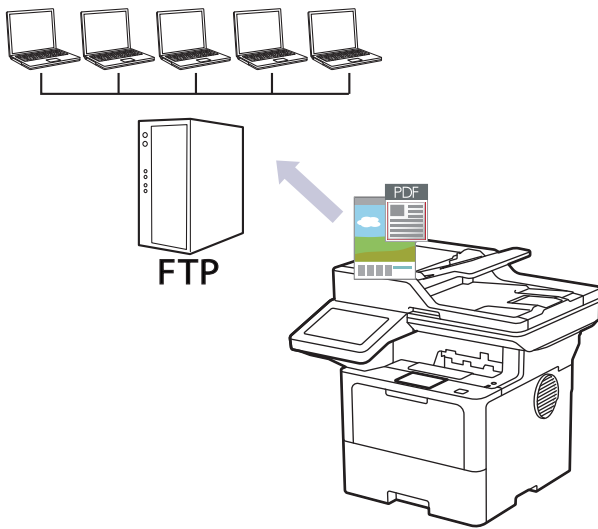

- [Set up a Scan to FTP Profile](#)
- [Upload Scanned Data to an FTP Server](#)

Set up a Scan to FTP Profile

Set up a Scan to FTP Profile to scan and upload the scanned data directly to an FTP location.

- We recommend using the latest version of the following web browsers:
 - Microsoft Edge, Firefox, and Google Chrome™ for Windows
 - Safari, Firefox, and Google Chrome™ for Mac
 - Google Chrome™ for Android™
 - Safari and Google Chrome™ for iOS
- Ensure that JavaScript and Cookies are always enabled, regardless of which browser you use.

1. Start your web browser.
2. Type "https://machine's IP address" in your browser's address bar (where "machine's IP address" is your machine's IP address).

For example:

https://192.168.1.2

3. If required, type the password in the **Login** field, and then click **Login**.



The default password to manage this machine's settings is located on the back of the machine and marked "Pwd".

4. Go to the navigation menu, and then click **Scan > Scan to FTP / SFTP / Network / SharePoint**.



Start from , if the navigation menu is not shown on the left side of the screen.

5. Select the **FTP** option, and then click **Submit**.
6. Click the **Scan to FTP / SFTP / Network / SharePoint Profile** menu.
7. Select the profile you want to set up or change.



Using the following characters: ?, /, \, ", :, <, >, | or * may cause a sending error.

Option	Description
Profile Name	Type a name for this server profile (up to 15 alphanumeric characters). The machine will display this name on the LCD.
Host Address	Type the Host Address (for example: ftp.example.com; up to 64 characters) or the IP address (for example: 192.23.56.189).
Port Number	Change the Port Number setting used to access the FTP server. The default setting is port 21. In most cases, this setting does not need to be changed.
Username	Type a user name (up to 32 characters) of a user that has permission to write data to the FTP server.
Password	Type the password (up to 32 characters) associated with the user name you entered in the Username field. Type the password again in the Retype password field.
SSL/TLS	Set the SSL/TLS option to scan securely using SSL/TLS communication. Change the CA Certificate setting, if needed.
Store Directory	Type the path to the folder on the FTP server where you want to send your scanned data. Do not type a slash mark at the beginning of the path (see example).

Option	Description
	<p>Store Directory</p> <input type="text" value="brother/abc"/>
File Name	Select a file name prefix from the preset names provided, or from user-defined names. The file name used for the scanned document will be the file name prefix you select, followed by the last six digits of the flatbed/ADF scanner counter and the file extension (for example: "Estimate_098765.pdf").
Quality	Select a quality setting. If you choose the User Select option, the machine will prompt users to select a setting each time they use the scan profile.
File Type	Select the file type you want to use for the scanned document. If you choose the User Select option, the machine will prompt users to select a setting each time they use the scan profile.
Document Size	Select your document size from the list. This is necessary to make sure the scanned file is the correct size. If you choose the User Select option, the machine will prompt users to select a setting each time they use the scan profile.
File Size	Select your file size from the list. If you choose the User Select option, the machine will prompt users to select a setting each time they use the scan profile.
Auto Deskew	Select the Auto option to set the machine to correct document skewing automatically as the pages are scanned.
Skip Blank Page	Select the On option to remove blank pages of the document from the scanning results.
Skip Blank Page Sensitivity	Select the sensitivity level for detecting blank pages in the scanned data. The higher the sensitivity, the easier it is for the machine to detect blank pages.
2-sided Scan (MFC-L5718DN/ MFC-L5728DW)	Select the Long Edge or Short Edge option to scan both sides of the document, depending on the layout of your original.
Remove Background Color	Change the amount of background colour that is removed.
Margin Settings (available only for certain models)	Adjust your document's margins.
Document Separation	Split a scanned image. When multiple documents have been scanned, you can split and save the documents separately by using this function.
B&W TIFF Compression	Select the TIFF compression option for a black and white document.
Brightness	Select the brightness level.
Contrast	Select the contrast level.
Passive Mode	Set the Passive Mode option to off or on depending on your FTP server and network firewall configuration. The default setting is on. In most cases, this setting does not need to be changed.

8. Click **Submit**.



Related Information

- [Scan to FTP](#)

Upload Scanned Data to an FTP Server

Share scanned information by saving it to your FTP server.

1. Load your document.
2. Press [Scan] > [to FTP/SFTP].
3. When the server profiles you set up using Web Based Management appear, select the profile you want. If the profile is not complete (for example, if the logon account name and password are missing, or if the quality or file type is not specified), you will be prompted to enter any missing information.
4. Press [Start].

The machine starts scanning. If using the machine's scanner glass, follow the touchscreen instructions to complete the scanning job.



Related Information

- [Scan to FTP](#)

Scan to SSH Server (SFTP)

Uses the Secure Shell Protocol to establish a private and safe data stream when scanning documents to a network destination. For added convenience, configure different profiles to save your favourite Scan to SFTP destinations.

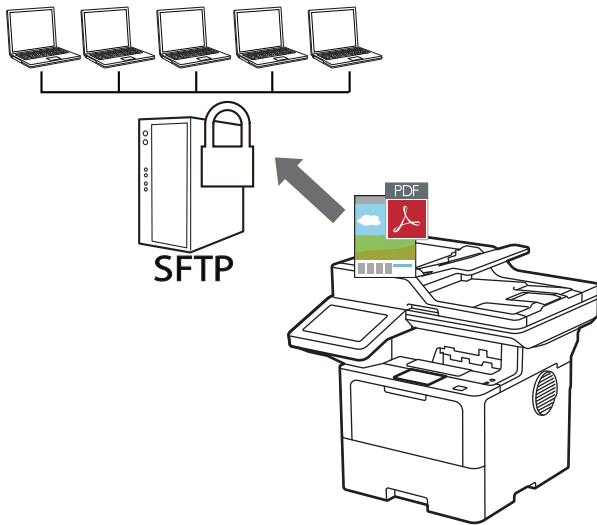

- [Set up a Scan to SFTP Profile](#)
- [Create a Client Key Pair Using Web Based Management](#)
- [Export a Client Key Pair Using Web Based Management](#)
- [Import a Server Public Key Using Web Based Management](#)
- [Upload Scanned Data to an SFTP Server](#)

Set up a Scan to SFTP Profile

Set up a Scan to SFTP Profile to scan and upload scanned data directly to an SFTP location.

- We recommend using the latest version of the following web browsers:
 - Microsoft Edge, Firefox, and Google Chrome™ for Windows
 - Safari, Firefox, and Google Chrome™ for Mac
 - Google Chrome™ for Android™
 - Safari and Google Chrome™ for iOS
- Ensure that JavaScript and Cookies are always enabled, regardless of which browser you use.

1. Start your web browser.
2. Type "https://machine's IP address" in your browser's address bar (where "machine's IP address" is your machine's IP address).

For example:

https://192.168.1.2

3. If required, type the password in the **Login** field, and then click **Login**.



The default password to manage this machine's settings is located on the back of the machine and marked "Pwd".

4. Go to the navigation menu, and then click **Scan > Scan to FTP / SFTP / Network / SharePoint**.



Start from , if the navigation menu is not shown on the left side of the screen.

5. Select the **SFTP** option, and then click **Submit**.
6. Click the **Scan to FTP / SFTP / Network / SharePoint Profile** menu.
7. Select the profile you want to set up or change.



Using the following characters: ?, /, \, ", :, <, >, | or * may cause a sending error.

Option	Description
Profile Name	Type a name for this server profile (up to 15 alphanumeric characters). The machine will display this name on the LCD.
Host Address	Type the Host Address (for example: ftp.example.com; up to 64 characters) or the IP address (for example: 192.23.56.189).
Username	Type a user name (up to 32 characters) of a user that has permission to write data to the SFTP server.
Auth. Method	Select Password or Public Key .
Password	When you select Password for the Auth. Method option, type the password (up to 32 characters) associated with the user name you typed in the Username field. Type the password again in the Retype password field.
Client Key Pair	When you select Public Key for the Auth. Method option, select the authentication type.
Server Public Key	Select the authentication type.
Store Directory	Type the path to the folder on the SFTP server where you want to send your scanned data. Do not type a slash mark at the beginning of the path (see example).

Option	Description
	<p>Store Directory</p> <input type="text" value="brother/abc"/>
File Name	Select a file name prefix from the preset names provided, or from user-defined names. The file name used for the scanned document will be the file name prefix you select, followed by the last six digits of the flatbed/ADF scanner counter and the file extension (for example: "Estimate_098765.pdf").
Quality	Select a quality setting. If you choose the User Select option, the machine will prompt users to select a setting each time they use the scan profile.
File Type	Select the file type you want to use for the scanned document. If you choose the User Select option, the machine will prompt users to select a setting each time they use the scan profile.
Document Size	Select your document size from the list. This is necessary to make sure the scanned file is the correct size. If you choose the User Select option, the machine will prompt users to select a setting each time they use the scan profile.
File Size	Select your file size from the list. If you choose the User Select option, the machine will prompt users to select a setting each time they use the scan profile.
Auto Deskew	Select the Auto option to set the machine to correct document skewing automatically as the pages are scanned.
Skip Blank Page	Select the On option to remove blank pages of the document from the scanning results.
Skip Blank Page Sensitivity	Select the sensitivity level for detecting blank pages in the scanned data. The higher the sensitivity, the easier it is for the machine to detect blank pages.
2-sided Scan (MFC-L5718DN/ MFC-L5728DW)	Select the Long Edge or Short Edge option to scan both sides of the document, depending on the layout of your original.
Remove Background Color	Change the amount of background colour that is removed.
Margin Settings (available only for certain models)	Adjust your document's margins.
Document Separation	Split a scanned image. When multiple documents have been scanned, you can split and save the documents separately by using this function.
B&W TIFF Compression	Select the TIFF compression option for a black and white document.
Brightness	Select the brightness level.
Contrast	Select the contrast level.
Port Number	Change the Port Number setting used to access the SFTP server. The default setting is port 22. In most cases, this setting does not need to be changed.

8. Click **Submit**.



Related Information

- [Scan to SSH Server \(SFTP\)](#)

Create a Client Key Pair Using Web Based Management

1. Start your web browser.
2. Type "https://machine's IP address" in your browser's address bar (where "machine's IP address" is your machine's IP address).

For example:

https://192.168.1.2



- If you are using a Domain Name System or enable a NetBIOS name, you can type another name, such as "SharedPrinter" instead of the IP address.

For example: https://SharedPrinter

- If you enable a NetBIOS name, you can also use the node name.

For example: https://brn123456abcdef

- The NetBIOS name can be found in the Network Configuration Report.

3. If required, type the password in the **Login** field, and then click **Login**.



The default password to manage this machine's settings is located on the back of the machine and marked "Pwd".

4. Go to the navigation menu, and then click **Network > Security > Client Key Pair**.



Start from ☰, if the navigation menu is not shown on the left side of the screen.

5. Click **Create New Client Key Pair**.
6. In the **Client Key Pair Name** field, type the name (up to 20 characters) you want.
7. Click the **Public Key Algorithm** drop-down list, and then select the algorithm you want.
8. Click **Submit**.

The client key pair is created and saved in your machine's memory. The client key pair name and public key algorithm will be displayed in the **Client Key Pair List**.



Related Information

- [Scan to SSH Server \(SFTP\)](#)

Export a Client Key Pair Using Web Based Management

1. Start your web browser.
2. Type "https://machine's IP address" in your browser's address bar (where "machine's IP address" is your machine's IP address).

For example:

https://192.168.1.2



- If you are using a Domain Name System or enable a NetBIOS name, you can type another name, such as "SharedPrinter" instead of the IP address.

For example: https://SharedPrinter

- If you enable a NetBIOS name, you can also use the node name.

For example: https://brn123456abcdef

- The NetBIOS name can be found in the Network Configuration Report.

3. If required, type the password in the **Login** field, and then click **Login**.



The default password to manage this machine's settings is located on the back of the machine and marked "Pwd".

4. Go to the navigation menu, and then click **Network > Security > Client Key Pair**.



Start from ☰, if the navigation menu is not shown on the left side of the screen.

5. Click **Export Public Key** shown with **Client Key Pair List**.
6. Click **Submit**.
7. Specify the location where you want to save the file.

The client key pair is exported to your computer.



Related Information

- [Scan to SSH Server \(SFTP\)](#)

Import a Server Public Key Using Web Based Management

1. Start your web browser.
2. Type "https://machine's IP address" in your browser's address bar (where "machine's IP address" is your machine's IP address).

For example:

https://192.168.1.2



- If you are using a Domain Name System or enable a NetBIOS name, you can type another name, such as "SharedPrinter" instead of the IP address.

For example: https://SharedPrinter

- If you enable a NetBIOS name, you can also use the node name.

For example: https://brn123456abcdef

- The NetBIOS name can be found in the Network Configuration Report.

3. If required, type the password in the **Login** field, and then click **Login**.



The default password to manage this machine's settings is located on the back of the machine and marked "Pwd".

4. Go to the navigation menu, and then click **Network > Security > Server Public Key**.



Start from ☰, if the navigation menu is not shown on the left side of the screen.

5. Click **Import Server Public Key**.
6. Specify the file that you want to import.
7. Click **Submit**.

The server public key is imported to your machine.



Related Information

- [Scan to SSH Server \(SFTP\)](#)

Upload Scanned Data to an SFTP Server

1. Load your document.
2. Press [Scan] > [to FTP/SFTP].
3. When the server profiles you set up using Web Based Management appear, select the profile you want. If the profile is not complete (for example, if the logon account name and password are missing, or if the quality or file type is not specified), you will be prompted to enter any missing information.
4. Press [Start].

The machine starts scanning. If using the machine's scanner glass, follow the touchscreen instructions to complete the scanning job.



Related Information

- [Scan to SSH Server \(SFTP\)](#)

Scan to Network (Windows)

Scan documents directly to a CIFS server on your local network. For added convenience, you can configure different profiles to save your favourite Scan to Network destinations.

- [Set up a Scan to Network Profile](#)
- [Upload Scanned Data to a CIFS Server](#)

Set up a Scan to Network Profile

Set up a Scan to Network Profile to scan and upload scanned data directly to a folder on a CIFS server.

- We recommend using the latest version of the following web browsers:
 - Microsoft Edge, Firefox, and Google Chrome™ for Windows
 - Safari, Firefox, and Google Chrome™ for Mac
 - Google Chrome™ for Android™
 - Safari and Google Chrome™ for iOS
- Ensure that JavaScript and Cookies are always enabled, regardless of which browser you use.

1. Start your web browser.
2. Type "https://machine's IP address" in your browser's address bar (where "machine's IP address" is your machine's IP address).

For example:

https://192.168.1.2

3. If required, type the password in the **Login** field, and then click **Login**.



The default password to manage this machine's settings is located on the back of the machine and marked "Pwd".

4. Go to the navigation menu, and then click **Scan > Scan to FTP / SFTP / Network / SharePoint**.



Start from , if the navigation menu is not shown on the left side of the screen.

5. Select the **Network** option, and then click **Submit**.



If you want to send the data to your designated folder on the CIFS server, select **On** for the **Send to My Folder** option.

6. Click the **Scan to FTP / SFTP / Network / SharePoint Profile** menu.
7. Select the profile you want to set up or change.



Using the following characters: ?, /, \, ", :, <, >, | or * may cause a sending error.

Option	Description
Profile Name	Type a name for this server profile (up to 15 alphanumeric characters). The machine will display this name on the LCD.
Network Folder Path	Type the path to the folder on the CIFS server where you want to send your scanned data.
File Name	Select a file name prefix from the preset names provided, or from user-defined names. The file name used for the scanned document will be the file name prefix you select, followed by the last six digits of the flatbed/ADF scanner counter and the file extension (for example: "Estimate_098765.pdf").
Quality	Select a quality setting. If you choose the User Select option, the machine will prompt users to select a setting each time they use the scan profile.
File Type	Select the file type you want to use for the scanned document. If you choose the User Select option, the machine will prompt users to select a setting each time they use the scan profile.

Option	Description
Document Size	Select your document size from the list. This is necessary to make sure the scanned file is the correct size. If you choose the User Select option, the machine will prompt users to select a setting each time they use the scan profile.
File Size	Select your file size from the list. If you choose the User Select option, the machine will prompt users to select a setting each time they use the scan profile.
Auto Deskew	Select the Auto option to set the machine to correct document skewing automatically as the pages are scanned.
Skip Blank Page	Select the On option to remove blank pages of the document from the scanning results.
Skip Blank Page Sensitivity	Select the sensitivity level for detecting blank pages in the scanned data. The higher the sensitivity, the easier it is for the machine to detect blank pages.
2-sided Scan (MFC-L5718DN/ MFC-L5728DW)	Select the Long Edge or Short Edge option to scan both sides of the document, depending on the layout of your original.
Remove Background Color	Change the amount of background colour that is removed.
Margin Settings (available only for certain models)	Adjust your document's margins.
Document Separation	Split a scanned image. When multiple documents have been scanned, you can split and save the documents separately by using this function.
B&W TIFF Compression	Select the TIFF compression option for a black and white document.
Brightness	Select the brightness level.
Contrast	Select the contrast level.
Use PIN for Authentication	To PIN-protect this profile, select On and type a four-digit PIN in the PIN Code field.
Auth. Method	To set your authentication method, select Auto , Kerberos , or NTLMv2 .
Username	Type a user name (up to 96 characters) of a user that has permission to write data to the folder specified in the Network Folder Path field. If the user name is part of a domain, enter the user name in one of the following styles: <ul style="list-style-type: none"> • user@domain • domain\user
Password	Type the password (up to 32 characters) associated with the user name you entered in the Username field. Type the password again in the Retype password field.
Kerberos Server Address	To set the Kerberos Server Address manually, type the Kerberos Server Address (for example: kerberos.example.com; up to 64 characters).

- Click **Submit**.
- You must configure the SNTP protocol (network time server) or set the date, time and time zone correctly on the control panel for all authentication methods. The machine's time must match the time used by the Kerberos Server and CIFS Server.



Related Information

- [Scan to Network \(Windows\)](#)
 - [Set the Date and Time Using Web Based Management](#)

Set the Date and Time Using Web Based Management

Make sure the date and time and the time zone settings are set correctly using Web Based Management or the control panel. The machine's time must match the time used by the server providing authentication.

- We recommend using the latest version of the following web browsers:
 - Microsoft Edge, Firefox, and Google Chrome™ for Windows
 - Safari, Firefox, and Google Chrome™ for Mac
 - Google Chrome™ for Android™
 - Safari and Google Chrome™ for iOS
- Ensure that JavaScript and Cookies are always enabled, regardless of which browser you use.
- Ignore step 1, if you already have a Web Based Management window open.

1. Start your web browser.
2. Type "https://machine's IP address" in your browser's address bar (where "machine's IP address" is your machine's IP address).

For example:

https://192.168.1.2

3. If required, type the password in the **Login** field, and then click **Login**.



The default password to manage this machine's settings is located on the back of the machine and marked "Pwd".

4. Go to the navigation menu, and then click **Administrator** > **Date&Time**.



Start from ☰, if the navigation menu is not shown on the left side of the screen.

Date&Time

Date

 / /

Clock Type

- 12h Clock
 24h Clock

Time

 :

Time Zone

Auto Daylight

- Off
 On

Synchronize with SNTP server

To synchronize the "Date&Time" with your SNTP server, you must configure the SNTP server settings.

[SNTP>>](#)

5. Clear the **Synchronize with SNTP server** checkbox.
6. In the **Date** fields, enter the date.
7. Select the clock type from the **Clock Type** field.
8. In the **Time** fields, enter the time.
9. Select the time difference between your location and UTC from the **Time Zone** drop-down list. For example, the time zone for Eastern time in the USA and Canada is UTC-05:00.
10. Click **Submit**.



Related Information

- [Set up a Scan to Network Profile](#)
-

Upload Scanned Data to a CIFS Server

1. Load your document.
2. Press [Scan] > [to Network].



- If you registered your user ID, the [to My Folder] option appears when you log on to the machine using Active Directory Authentication or LDAP Authentication.
- To send scanned data to your designated folder on the CIFS server, press [to My Folder].
- To enable this feature in Web Based Management, click the **Scan** tab, and then click the **Scan to FTP / SFTP / Network / SharePoint** menu in the left navigation bar. In the **Send to My Folder** field, select **On**. Click **Submit**.

3. When the server profiles you set up using Web Based Management appear, select the profile you want. If the profile is not complete (for example, if the logon account name and password are missing, or if the quality or file type is not specified), you will be prompted to enter any missing information.



- If the LCD prompts you to enter a PIN for the computer, enter the four-digit PIN on the LCD, and then press [OK].

4. Press [Start].

The machine starts scanning. If using the machine's scanner glass, follow the touchscreen instructions to complete the scanning job.



Related Information

- [Scan to Network \(Windows\)](#)

Scan to SharePoint

Scan documents directly to a SharePoint server when you need to share the scanned information. For added convenience, configure different profiles to save your favourite Scan to SharePoint destinations.

- [Set up a Scan to SharePoint Profile](#)
- [Upload Scanned Data to a SharePoint Server](#)

Set up a Scan to SharePoint Profile

Set up a Scan to SharePoint Profile to scan and upload the scanned data directly to a SharePoint location.

- We recommend using the latest version of the following web browsers:
 - Microsoft Edge, Firefox, and Google Chrome™ for Windows
 - Safari, Firefox, and Google Chrome™ for Mac
 - Google Chrome™ for Android™
 - Safari and Google Chrome™ for iOS
- Ensure that JavaScript and Cookies are always enabled, regardless of which browser you use.

1. Start your web browser.
2. Type "https://machine's IP address" in your browser's address bar (where "machine's IP address" is your machine's IP address).

For example:

https://192.168.1.2

3. If required, type the password in the **Login** field, and then click **Login**.



The default password to manage this machine's settings is located on the back of the machine and marked "Pwd".

4. Go to the navigation menu, and then click **Scan > Scan to FTP / SFTP / Network / SharePoint**.



Start from , if the navigation menu is not shown on the left side of the screen.

5. Select the **SharePoint** option, and then click **Submit**.
6. Click the **Scan to FTP / SFTP / Network / SharePoint Profile** menu.
7. Select the profile you want to set up or change.

NOTE

Using the following characters: ?, /, \, ", :, <, >, | or * may cause a sending error.

Option	Description
Profile Name	Type a name for this server profile (up to 15 alphanumeric characters). The machine will display this name on the LCD.
SharePoint Site Address	Copy and paste the full destination address shown in the address bar of your browser (for example: http://SharePointSiteAddress/Shared%20Documents/Forms/AllItems.aspx) or the IP address (for example: http://192.168.0.1/Shared%20Documents/Forms/AllItems.aspx).
SSL/TLS	If you enter the address starting from "https://" in the SharePoint Site Address field, you can verify the server certificate by checking the Verify Server Certificate check.
File Name	Select a file name prefix from the preset names provided, or from user-defined names. The file name used for the scanned document will be the file name prefix you select, followed by the last six digits of the flatbed/ADF scanner counter and the file extension (for example: "Estimate_098765.pdf").
Quality	Select a quality setting. If you choose the User Select option, the machine will prompt users to select a setting each time they use the scan profile.

Option	Description
File Type	Select the file type you want to use for the scanned document. If you choose the User Select option, the machine will prompt users to select a setting each time they use the scan profile.
Document Size	Select your document size from the list. This is necessary to make sure the scanned file is the correct size. If you choose the User Select option, the machine will prompt users to select a setting each time they use the scan profile.
File Size	Select your file size from the list. If you choose the User Select option, the machine will prompt users to select a setting each time they use the scan profile.
Auto Deskew	Select the Auto option to set the machine to correct document skewing automatically as the pages are scanned.
Skip Blank Page	Select the On option to remove blank pages of the document from the scanning results.
Skip Blank Page Sensitivity	Select the sensitivity level for detecting blank pages in the scanned data. The higher the sensitivity, the easier it is for the machine to detect blank pages.
2-sided Scan (MFC-L5718DN/ MFC-L5728DW)	Select the Long Edge or Short Edge option to scan both sides of the document, depending on the layout of your original.
Remove Background Color	Change the amount of background colour that is removed.
Margin Settings (available only for certain models)	Adjust your document's margins.
Document Separation	Split a scanned image. When multiple documents have been scanned, you can split and save the documents separately by using this function.
B&W TIFF Compression	Select the TIFF compression option for a black and white document.
Brightness	Select the brightness level.
Contrast	Select the contrast level.
Use PIN for Authentication	To PIN-protect this profile, select On and type a four-digit PIN in the PIN Code field.
Auth. Method	To set your authentication method, select Auto , NTLMv2 , Kerberos , or Basic . If you choose Auto , the authentication method will be detected automatically.
Username	Type the user name (up to 96 characters) of a user that has permission to write data to the folder specified in the SharePoint Site Address field. If the user name is part of a domain, enter the user name in one of the following styles: <ul style="list-style-type: none"> • user@domain • domain\user
Password	Type the password (up to 32 characters) associated with the user name you entered in the Username field. Type the password again in the Retype password field.
Kerberos Server Address	To set the Kerberos Server Address manually, type the Kerberos Server Address (for example: kerberos.example.com; up to 64 characters).

8. Click **Submit**.



Related Information

- [Scan to SharePoint](#)

Upload Scanned Data to a SharePoint Server

1. Load your document.
2. Press [Scan] > [to SharePoint].
3. When the server profiles you set up using Web Based Management appear, select the profile you want. If the profile is not complete (for example, if the logon account name and password are missing, or if the quality or file type is not specified), you will be prompted to enter any missing information.



If the LCD prompts you to enter a PIN for the computer, enter the four-digit PIN on the LCD, and then press [OK]

4. Press [Start].
The machine starts scanning. If using the machine's scanner glass, follow the touchscreen instructions to complete the scanning job.



Related Information

- [Scan to SharePoint](#)

Use the Web Services Protocol for Network Scanning (Windows 10 and Windows 11)

The Web Services protocol enables Windows 10 and Windows 11 users to scan using a Brother machine on the network. You must install the driver via Web Services.

- [Use the Web Services Protocol to Install the Scanner Driver \(Windows 10 and Windows 11\)](#)
- [Scan From Your Machine Using the Web Services Protocol \(Windows 10 and Windows 11\)](#)
- [Configure Scan Settings for the Web Services Protocol](#)

Use the Web Services Protocol to Install the Scanner Driver (Windows 10 and Windows 11)

- Make sure you have installed the correct software and drivers for your machine.
- Verify that the host computer and the Brother machine are on the same subnet, or that the router is correctly configured to pass data between the two devices.
- You must configure the IP address on your Brother machine before you configure this setting.

1. Do one of the following:

- Windows 11

Click  > **All apps** > **Windows Tools** > **Control Panel**. In the **Hardware and Sound** group, click **Add a device**.

- Windows 10

Click  > **Windows System** > **Control Panel**. In the **Hardware and Sound** group, click **Add a device**.



- The Web Services Name for the Brother machine is your model's name and the MAC Address.
- Move your mouse over the machine's name to display the machine's information.

2. Select the machine you want to install, and then follow the on-screen instructions.



To uninstall the drivers, click **Uninstall** or  (**Remove device**).



Related Information

- [Use the Web Services Protocol for Network Scanning \(Windows 10 and Windows 11\)](#)

Scan From Your Machine Using the Web Services Protocol (Windows 10 and Windows 11)

If you have installed the scanner driver via Web Services, you can access the Web Services scanning menu on your machine's LCD.

Certain characters in the messages displayed on the LCD may be replaced with spaces if the language settings of your operating system and your machine are different.

1. Load your document.
2. Press [Scan] > [WS Scan].
3. Select the scan type.
4. Select the computer name where you want to send scanned data.
5. Press [Start].



The machine starts scanning.

If you are requested to select a scanning application, select Windows Fax and Scan from the list.

Related Information

- [Use the Web Services Protocol for Network Scanning \(Windows 10 and Windows 11\)](#)

Configure Scan Settings for the Web Services Protocol

1. Do one of the following:
 - Windows 11
Click  > **All apps** > **Windows Tools** > **Control Panel**. In the **Hardware and Sound** group, click **View devices and printers**.
 - Windows 10
Click  > **Windows System** > **Control Panel**. In the **Hardware and Sound** group, click **View devices and printers**.
2. Right-click the machine icon, and then select **Scan profiles....** The **Scan Profiles** dialog box appears.
3. Select the scan profile you want to use.
4. Make sure the scanner selected in the **Scanner** list is a machine that supports Web Services for scanning, and then click the **Set as Default** button.
5. Click **Edit...**
The **Edit Default Profile** dialog box appears.
6. Select the **Source**, **Paper size**, **Color format**, **File type**, **Resolution (DPI)**, **Brightness** and **Contrast** settings.
7. Click the **Save Profile** button.
These settings will be applied when you scan using the Web Services protocol.

If the machine prompts you to select a scanning application, select Windows Fax and Scan from the list.



Related Information

- [Use the Web Services Protocol for Network Scanning \(Windows 10 and Windows 11\)](#)

Change the Scan Button Settings from Brother iPrint&Scan

Brother iPrint&Scan allows you to change the machine's Scan Button settings.

1. Start Brother iPrint&Scan.
 - Windows
Launch  (Brother iPrint&Scan).
 - Mac
In the **Finder** menu bar, click **Go > Applications**, and then double-click the iPrint&Scan icon.
The Brother iPrint&Scan screen appears.
2. If your Brother machine is not selected, click the **Select your Machine** button, and then follow the on-screen instructions to select your Brother machine.
3. Click the **Machine Scan Settings** button, and then follow the on-screen instructions to change the scan settings, such as document size, colour, and resolution.



Related Information

- [Scan Using the Scan Button on Your Machine](#)

Configure Certificates for Signed PDFs

If you select Signed PDF for Scan features, you must configure a certificate on your machine using Web Based Management.

To use Signed PDF, you must install a certificate on your machine and your computer.

1. Start your web browser.
2. Type "https://machine's IP address" in your browser's address bar (where "machine's IP address" is your machine's IP address).

For example:

https://192.168.1.2

3. If required, type the password in the **Login** field, and then click **Login**.



The default password to manage this machine's settings is located on the back of the machine and marked "Pwd".

4. Go to the navigation menu, and then click **Administrator** > **Signed PDF**.



Start from , if the navigation menu is not shown on the left side of the screen.

Signed PDF

Select the Certificate

(To use the Signed PDF, you need to configure the certificate.
You can configure the certificate by clicking the link below.)

[Certificate>>](#)

5. Click the **Select the Certificate** drop-down list, and then select the certificate.
6. Click **Submit**.



Related Information

- [Scan Using the Scan Button on Your Machine](#)
-

Disable Scanning from Your Computer

To disable the scan function on your computer, disable the Pull Scan setting using Web Based Management.

1. Start your web browser.
2. Type "https://machine's IP address" in your browser's address bar (where "machine's IP address" is your machine's IP address).

For example:

https://192.168.1.2

3. If required, type the password in the **Login** field, and then click **Login**.



The default password to manage this machine's settings is located on the back of the machine and marked "Pwd".

4. Go to the navigation menu, and then click **Scan > Scan from PC**.



Start from ☰, if the navigation menu is not shown on the left side of the screen.

5. In the **Pull Scan** field, click **Disabled**.
6. Click **Submit**.



Related Information

- [Scan Using the Scan Button on Your Machine](#)

Scan from Your Computer (Windows)

There are several ways you can use your computer to scan photos and documents on your machine. Use the software applications we provide or use your favourite scanning application.

- [Scan Using Brother iPrint&Scan \(Windows/Mac\)](#)
- [Scan Using Nuance™ PaperPort™ 14SE or Other Windows Applications](#)
- [Scan Using Windows Fax and Scan](#)

Scan Using Brother iPrint&Scan (Windows/Mac)

1. Start Brother iPrint&Scan.

- Windows

Launch  (Brother iPrint&Scan).

- Mac

In the **Finder** menu bar, click **Go > Applications**, and then double-click the iPrint&Scan icon.

The Brother iPrint&Scan screen appears.

2. If your Brother machine is not selected, click the **Select your Machine** button, and then select your model's name from the list. Click **OK**.

3. Click **OK** again.

4. Click the **Scan** icon, and then follow the on-screen instructions to scan your documents.



Related Information

- [Scan from Your Computer \(Windows\)](#)

Related Topics:

- [Brother iPrint&Scan](#)



Scan Using Nuance™ PaperPort™ 14SE or Other Windows Applications

You can use the Nuance™ PaperPort™ 14SE application for scanning.

- To download the Nuance™ PaperPort™ 14SE application, click  (**Brother Utilities**), select **Do More** in the left navigation bar, and then click **PaperPort**.
- Nuance™ PaperPort™ 14SE supports Windows 10 and Windows 11.
- For detailed instructions on using each application, click the application's **Help** menu, and then click **Getting Started Guide** in the **Help** ribbon.



The instructions for scanning in these steps are for PaperPort™ 14SE. For other Windows applications, the steps will be similar. PaperPort™ 14SE supports both TWAIN and WIA drivers; the TWAIN driver (recommended) is used in these steps.

1. Load your document.
2. Start PaperPort™ 14SE.
Do one of the following:
 - Windows 11
Click  > **All apps** > **Nuance PaperPort 14** > **PaperPort**.
 - Windows 10
Click  > **Nuance PaperPort 14** > **PaperPort**.
3. Click the **Desktop** menu, and then click **Scan Settings** in the **Desktop** ribbon.
The **Scan or Get Photo** panel appears on the left side of the screen.
4. Click **Select**.
5. From the available Scanners list, select your model with **TWAIN: TW** in the name.
6. Click **OK**.
7. Select the **Display scanner dialog box** checkbox in the **Scan or Get Photo** panel.
8. Click **Scan**.
The Scanner Setup dialog box appears.

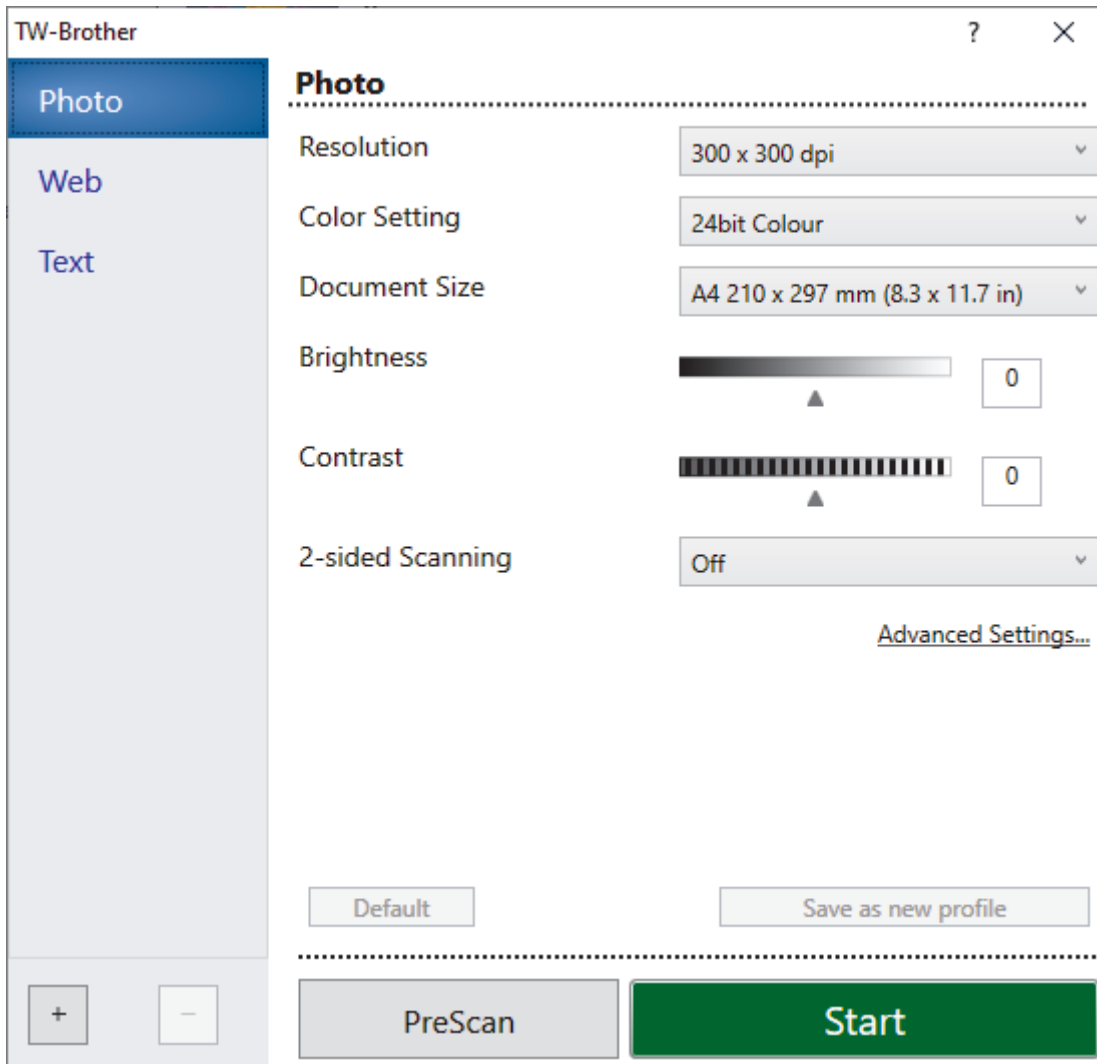

9. Adjust the settings in the Scanner Setup dialog box, if needed.
10. Click the **Document Size** drop-down list, and then select your document size.



To scan both sides of the document (MFC-L5718DN/MFC-L5728DW):
Automatic 2-sided scan is available only when using the ADF.
You cannot use PreScan to preview the scanned image.

11. Click **PreScan** to preview your image and crop unwanted portions before scanning.
12. Click **Start**.
The machine starts scanning.



Related Information

- [Scan from Your Computer \(Windows\)](#)
 - [TWAIN Driver Settings \(Windows\)](#)

TWAIN Driver Settings (Windows)

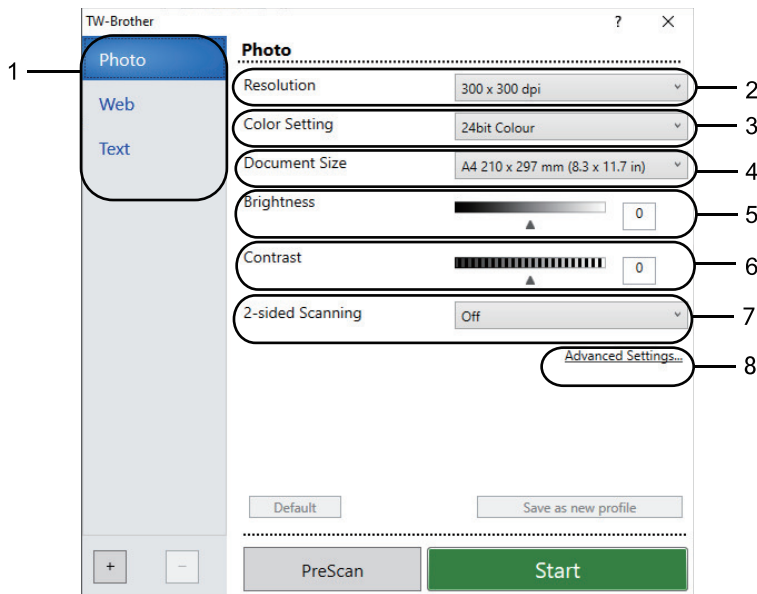

- Note that the item names and assignable values will vary depending on the machine.
- The **Contrast** option is available only when selecting the **Gray (Error Diffusion)**, **True Gray**, or **24bit Color** options from the **Color Setting** drop-down list.

1. Scan

Select the **Photo**, **Web**, or **Text** option depending on the type of document you want to scan.

Scan (Image Type)		Resolution	Colour Setting
Photo	Use for scanning photo images.	300 x 300 dpi	24bit Color
Web	Use for attaching scanned images to web pages.	100 x 100 dpi	24bit Color
Text	Use for scanning text documents.	200 x 200 dpi	Black & White

2. Resolution

Select a scanning resolution from the **Resolution** drop-down list. Higher resolutions take more memory and transfer time, but produce a finer higher quality scanned image.

3. Color Setting

Select from a range of scan colour depths.

- Black & White**
Use for text or line art images.
- Gray (Error Diffusion)**
Use for photographic images or graphics. (Error Diffusion is a method for creating simulated grey images without using true grey dots. Black dots are arranged in a specific pattern to give a grey appearance.)
- True Gray**
Use for photographic images or graphics. This mode is more accurate because it uses up to 256 shades of grey.
- 24bit Color**
Use to create an image with the most accurate colour reproduction. This mode uses up to 16.8 million colours to scan the image, but it requires the most memory and has the longest transfer time.

4. Document Size

Select the exact size of your document from a selection of preset scan sizes.

If you select **Custom**, the **Custom Document Size** dialog box appears and you can specify the document size.

5. Brightness

Set the brightness level by dragging the slider to the right or left to lighten or darken the image. If the scanned image is too light, set a lower brightness level and scan the document again. If the image is too dark, set a higher brightness level and scan the document again. You can also type a value in the field to set the brightness level.

6. Contrast

Increase or decrease the contrast level by moving the slider to the right or left. An increase emphasises dark and light areas of the image, while a decrease reveals more details in grey areas. You can also type a value in the field to set the contrast level.

7. 2-sided Scanning

Scan both sides of the document. When using the Automatic 2-sided Scan feature, you must select the **Long-edge binding** or **Short-edge binding** option from the **2-sided Scanning** drop-down list, so that when you turn the pages, they are facing the way you want.

(MFC-L5718DN/MFC-L5728DW)

8. Advanced Settings

Configure advanced settings by clicking the **Advanced Settings** button in the Scan Settings dialog box.

- **Document Correction**

- **Auto Deskew**

Set the machine to correct document skewing automatically as the pages are scanned.

- **Detect End of Page (ADF)**

Detects the end of page and automatically adjusts the size of a page when the length of the document scanned from the ADF is shorter than the selected document size.

- **Margin Settings** (available only for certain models)

Adjust the margins in your document.

- **Rotate Image**

Rotate the scanned image.

- **Fill With Color**

Fill in the edges on four sides of the scanned image using the selected colour and range.

- **Skip Blank Page**

Remove the document's blank pages from the scanning results.

- **Enhancement**

- **Background Processing**

- **Remove Bleed-through / Pattern**

Prevent bleed-through.

- **Remove Background Color**

Remove the base colour of documents to make the scanned data more legible.

- **Colour Drop**

Select a colour to remove from the scanned image.

- **Edge Emphasis**

Make the characters of the original sharper.

- **Reduce Noise**

Improve the quality of your scanned images with this selection. The **Reduce Noise** option is available when selecting the **24bit Color** option and the **300 x 300 dpi**, **400 x 400 dpi**, or **600 x 600 dpi** scan resolution.

- **B&W Image Quality**

-
- **Character Correction**
 - **Blurred Character Correction**

Correct the broken or incomplete characters of the original to make them easier to read.
 - **Boldface Formatting**

Emphasise the characters of the original by making them bold.
 - **B&W Inversion**

Invert black and white in the monochrome image.
 - **Feed Control**
 - **Layout**

Select the layout.
 - **Continuous scan**

Select this option to scan multiple pages. After a page is scanned, select whether to continue scanning or finish.



Related Information

- [Scan Using Nuance™ PaperPort™ 14SE or Other Windows Applications](#)
-

Scan Using Windows Fax and Scan

The Windows Fax and Scan application is another option that you can use for scanning.

- Windows Fax and Scan uses the WIA scanner driver.
- To crop a portion of a page after pre-scanning a document, you must scan using the scanner glass (also called the flatbed).

1. Load your document.
2. Launch Windows Fax and Scan.
3. Click **File > New > Scan**.
4. Select the scanner you want to use.
5. Click **OK**.

The **New Scan** dialog box appears.

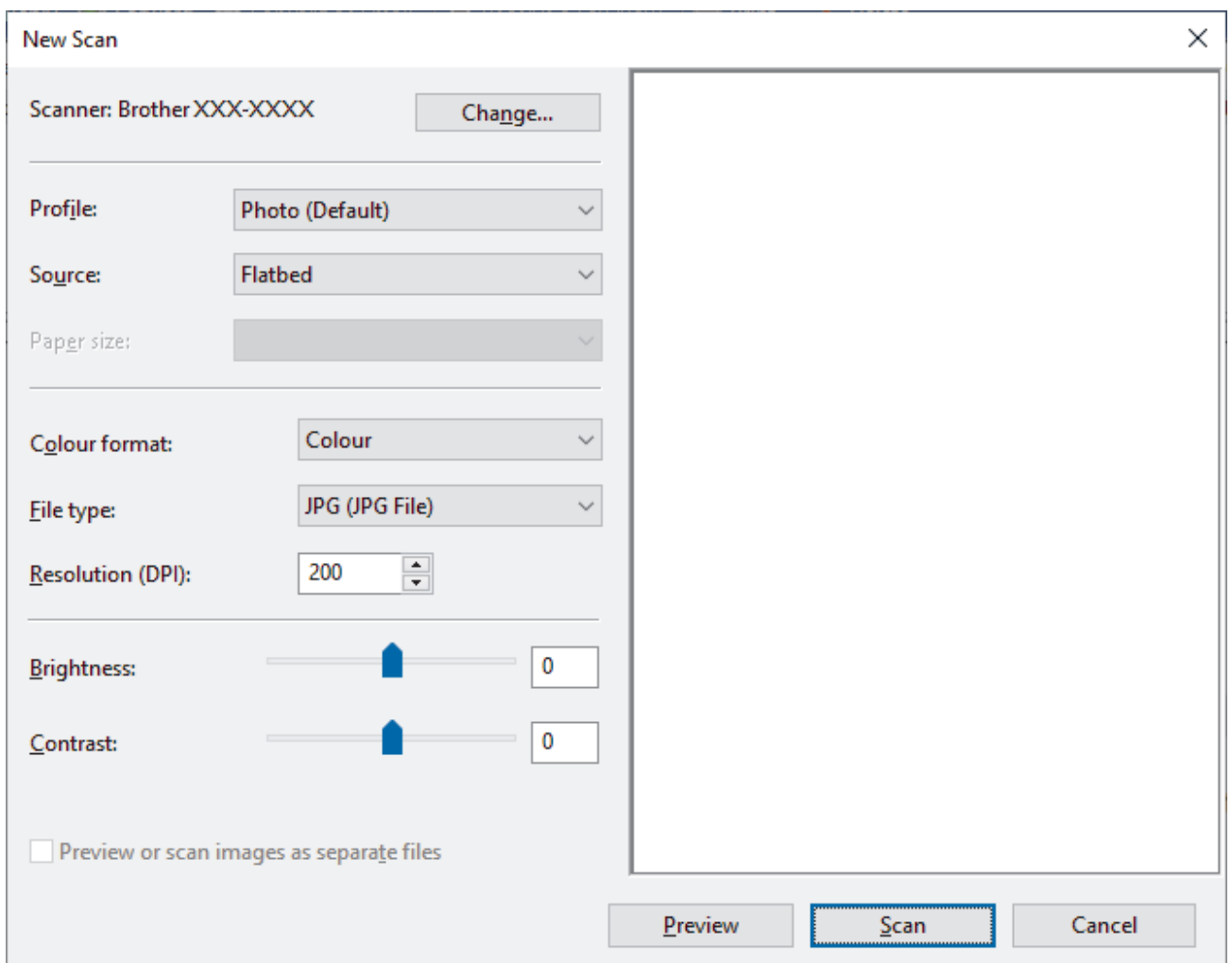

6. Adjust the settings in the dialog box, if needed.

The scanner resolution can be set to a maximum of 1200 dpi. If you want to scan at higher resolutions, use the **Scanner Utility** software from **Brother Utilities**.

If your machine supports 2-sided scanning and you want to scan both sides of your document, select **Feeder (Scan both sides)** from the Source drop-down list

7. Click **Scan**.

The machine starts scanning the document.



Related Information

- [Scan from Your Computer \(Windows\)](#)
 - [WIA Driver Settings \(Windows\)](#)
-

WIA Driver Settings (Windows)

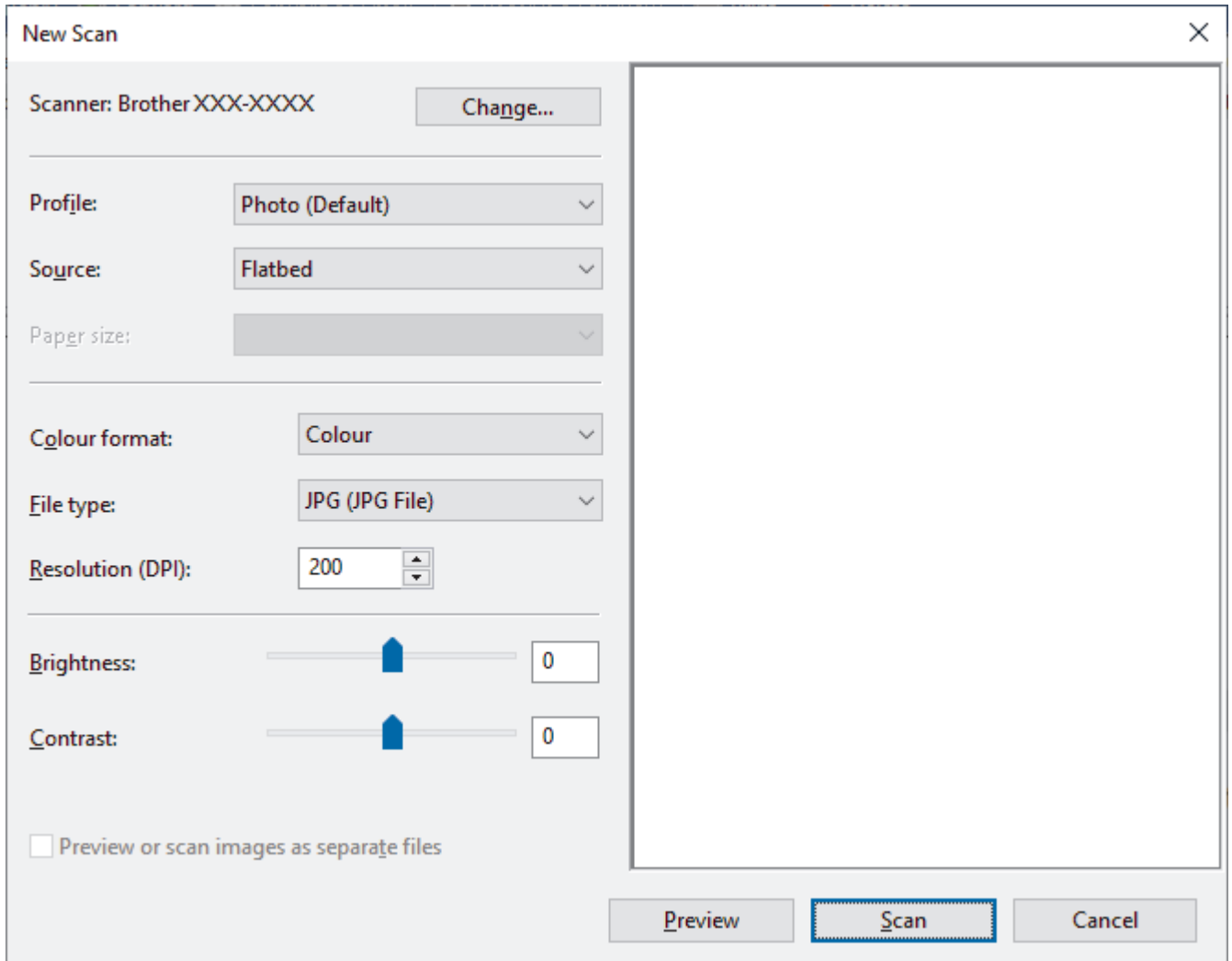

Profile

Select the scan profile you want to use from the **Profile** drop-down list.

Source

Select the **Flatbed**, **Feeder (Scan one side)**, or **Feeder (Scan both sides)** option from the drop-down list.

Paper size

The **Paper size** option is available if you select the **Feeder (Scan one side)** or **Feeder (Scan both sides)** option from the **Source** drop-down list.

Color format

Select a scan colour format from the **Color format** drop-down list.

File type

Select a file format from the **File type** drop-down list.

Resolution (DPI)

Set a scanning resolution in the **Resolution (DPI)** field. Higher resolutions take more memory and transfer time, but produce a finer higher quality scanned image.

Brightness

Set the brightness level by dragging the slider to the right or left to lighten or darken the image. If the scanned image is too light, set a lower brightness level and scan the document again. If the image is too dark, set a

higher brightness level and scan the document again. You can also type a value in the field to set the brightness level.

Contrast

Increase or decrease the contrast level by moving the slider to the right or left. An increase emphasises dark and light areas of the image, while a decrease reveals more details in grey areas. You can also type a value in the field to set the contrast level.



Related Information

- [Scan Using Windows Fax and Scan](#)

Scan from Your Computer (Mac)

- [Scan Using Brother iPrint&Scan \(Windows/Mac\)](#)
- [Scan Using AirPrint \(macOS\)](#)

Configure Scan Settings Using Web Based Management

- [Set the Scan File Name Using Web Based Management](#)
- [Set the Scan Job Email Report Using Web Based Management](#)

Set the Scan File Name Using Web Based Management

Set up a file name for scanned data using Web Based Management.

1. Start your web browser.
2. Type "https://machine's IP address" in your browser's address bar (where "machine's IP address" is your machine's IP address).

For example:

https://192.168.1.2

3. If required, type the password in the **Login** field, and then click **Login**.



The default password to manage this machine's settings is located on the back of the machine and marked "Pwd".

4. Go to the navigation menu, and then click **Scan > Scan File Name**.



Start from ☰, if the navigation menu is not shown on the left side of the screen.

5. Select the **File Name Style** from the drop-down list.
6. If you selected the option to include the date in **File Name Style** field, select the date format from the drop-down list.
7. In the **Time** field, select **On** to include the time information in the file name.
8. In the **Counter** field, select **Continuous** or **Reset after each job**.



If you select **Reset after each job**, duplication of file names may occur.

9. If you want to create a user-defined file name prefix, type a file name in the user-defined fields of each scan function.



Do not use the following characters: ? / \ *

10. Click **Submit**.



Related Information

- [Configure Scan Settings Using Web Based Management](#)

Set the Scan Job Email Report Using Web Based Management

When you scan a document, the machine will send a scan job email report automatically to the registered email address.

1. Start your web browser.
2. Type "https://machine's IP address" in your browser's address bar (where "machine's IP address" is your machine's IP address).

For example:

https://192.168.1.2

3. If required, type the password in the **Login** field, and then click **Login**.



The default password to manage this machine's settings is located on the back of the machine and marked "Pwd".

4. Go to the navigation menu, and then click **Scan > Scan Job e-mail report**.



Start from , if the navigation menu is not shown on the left side of the screen.

5. In the **Administrator Address** field, type the email address.
6. For the scan functions you want, select **On** to send a scan job email report.
7. Click **Submit**.



Related Information

- [Configure Scan Settings Using Web Based Management](#)

Copy

- [Copy on One Side of the Paper \(1-sided\)](#)
- [Copy on Both Sides of the Paper \(2-sided\)](#)
- [Enlarge or Reduce Copied Images](#)
- [Make N in 1 Copies Using the Page Layout Feature](#)
- [Copy an ID Card](#)
- [Copy Options](#)

Copy on One Side of the Paper (1-sided)

1. Make sure you have loaded the correct size paper in the paper tray.
2. Do one of the following:
 - Place the document *face up* in the ADF.
(If you are copying multiple pages, we recommend using the ADF.)

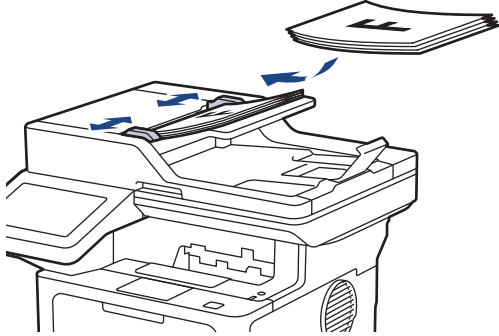

- Place the document *face down* on the scanner glass.

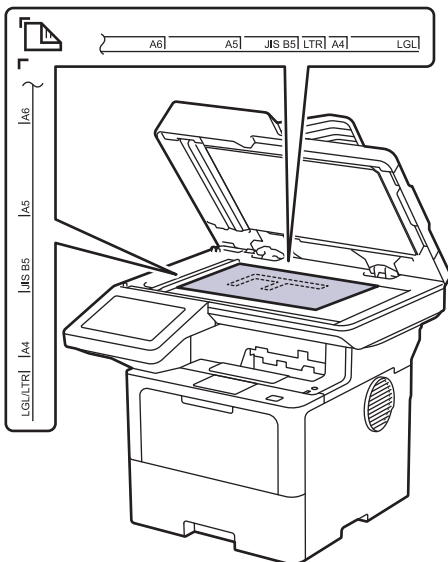

NOTE

For important or fragile documents, use the machine's scanner glass, not the ADF.

3. Press  [Copy].



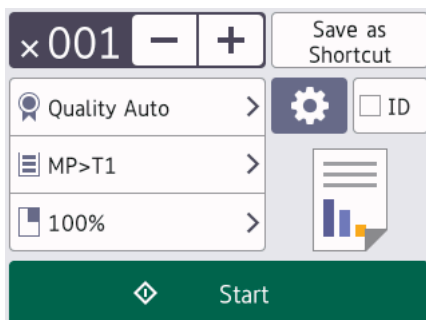

The LCD displays:



4. Change the copy settings, if needed.

- **001** (Number of copies)



Enter the number of copies in one of the following ways:

-
- Press  or  on the LCD.
 - Press  to display a numeric keypad on the LCD, and then enter the number of copies. Press [OK].
 -  [Options]
Press  to change the copy settings for the next copy only.
 - When finished, press [OK]. (If the [OK] button is displayed.)
 - After you have finished choosing new options, you can save them by pressing the [Save as Shortcut] button.
-



Current setting

Press the following display area to change these settings for the next copy only. The icon displayed varies depending on the model.

-  [Quality]
 -  [Tray Use]
 -  [Enlarge/Reduce]
-

5. Press [Start].



To stop copying, press .



Related Information

- [Copy](#)
-

Copy on Both Sides of the Paper (2-sided)

Reduce the amount of paper you use by copying onto both sides of the paper.

- You must choose a 2-sided copy layout from the following options before you can start 2-sided copying.
- The layout of your original document determines which 2-sided copy layout you should choose.
- For important or fragile documents, use the machine's scanner glass, not the ADF.
- To use the automatic 2-sided copy feature, you must load your document in the ADF.
- When you manually make 2-sided copies from a 2-sided document, use the scanner glass.
- Select A4 sized paper when using the 2-sided copy option.

Portrait

2-sided to 2-sided

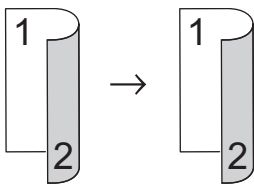

1-sided to 2-sided (Long Edge Flip)

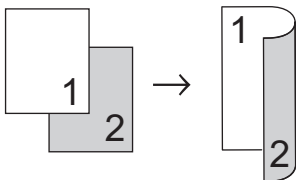

1-sided to 2-sided (Short Edge Flip)

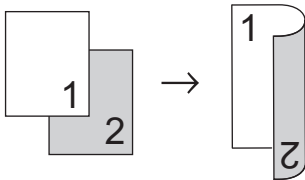

Landscape

2-sided to 2-sided

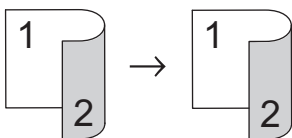

1-sided to 2-sided (Long Edge Flip)

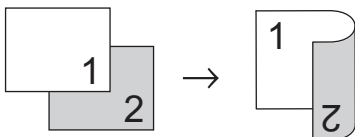

1-sided to 2-sided (Short Edge Flip)

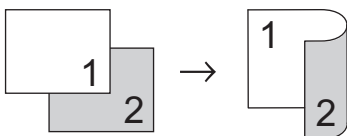

1. Load your document.

NOTE

- (For MFC-L5718DN/MFC-L5728DW) Load your 2-sided document in the ADF. If you use the scanner glass for your 2-sided document, select the [1-sided⇒2-sided] option.
- (For DCP-L5518DN) Load your 2-sided document to the scanner glass.

2. Press  [Copy].
3. Enter the number of copies.
4. Press [Options] > [2-sided Copy].
5. Do one of the following:
 - To make 2-sided copies of a 2-sided document, press [2-sided⇒2-sided].
 - To make 2-sided copies from a 1-sided document, follow these steps:
 - a. To change the layout options, press [Layout], and then press [Long Edge Flip] or [Short Edge Flip].
 - b. Press [1-sided⇒2-sided].

NOTE

(For DCP-L5518DN) If you select [2-sided⇒2-sided], you cannot use the ADF. Use the scanner glass.

6. When finished, press [OK]. (If the [OK] button is displayed.)
7. Press [Start].

If you placed the document in the ADF, the machine scans the pages and starts printing.
8. **If you are using the scanner glass, repeat the following steps for each page of the document:**



For a 2-sided document, turn the sheet over along the long edge to scan the other side.

- Place the next page on the scanner glass, and then press [Continue] to scan the page.
- After scanning all the pages, press [Finish].







Related Information

- [Copy](#)

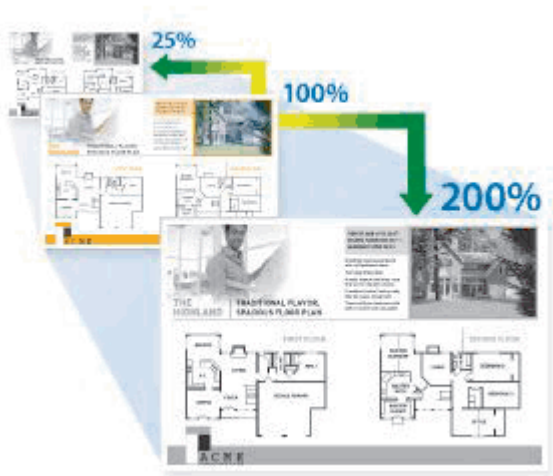
Enlarge or Reduce Copied Images

Select an enlargement or reduction ratio to resize your copied data.



1. Load your document.
 2. Press  [Copy].
 3. Enter the number of copies.
 4. Press [Options] > [Enlarge/Reduce].
 5. Press the option you want.
 6. Do one of the following:
 - If you select [Enlarge] or [Reduce], press the enlargement or reduction ratio you want to use.
 - If you select [Custom (25-400%)], press  (backspace) to erase the displayed percentage, or press  to move the cursor, and then enter an enlargement or reduction ratio from [25] to [400]. Press [OK].
 - If you selected [100%] or [Auto], go to the next step.
-
-  • [Auto] sets the machine to calculate the reduction ratio that best fits the size of paper.
- [Auto] is only available when using the ADF.
-
7. When finished, press [OK]. (If the [OK] button is displayed.)
 8. Press [Start].



Related Information



- [Copy](#)

Make N in 1 Copies Using the Page Layout Feature

The N in 1 copy feature saves paper by copying two or four pages of your document onto one page of the copy.

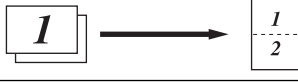

1. Load your document.
2. Press  [Copy].
3. Enter the number of copies.
4. Press  [Options] > [Page Layout].
5. Swipe up or down or press ▲ or ▼ to display the options, and then press the option you want.

Option	Description
2in1 (Portrait)	
2in1 (Landscape)	
4in1 (Portrait)	
4in1 (Landscape)	

6. When finished, press [OK]. (If the [OK] button is displayed.)
7. Press [Start].
If you placed the document in the ADF, the machine scans the pages and starts printing.
8. If you are using the scanner glass, repeat the following steps for each page of the document:
 - Place the next page on the scanner glass, and then press [Continue] to scan the page.
 - After scanning all the pages, press [Finish].

✓ Related Information

- [Copy](#)

Copy an ID Card

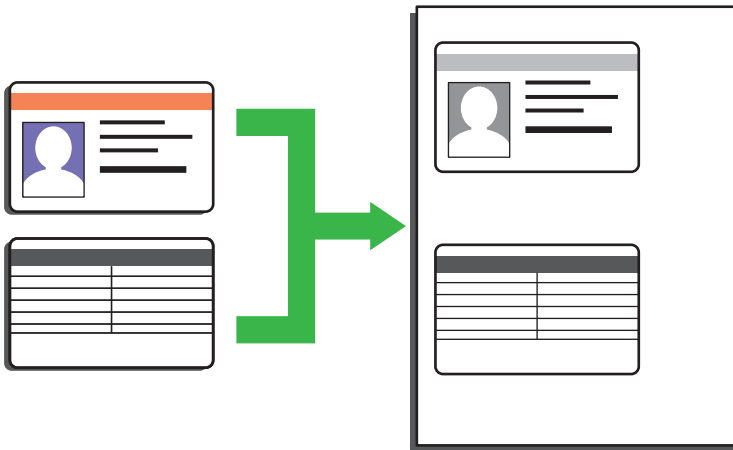

You may copy an identification card only to the extent permitted under applicable laws. For more detailed information, see the *Product Safety Guide*.

1. Place your identification card *face down* near the upper left corner of the scanner glass.

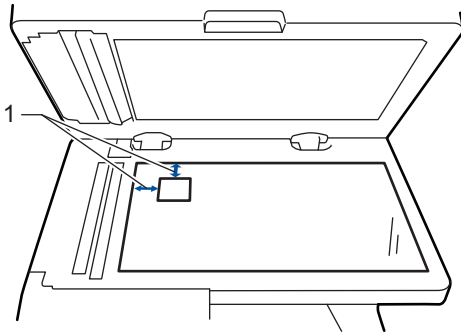

1: Distance 4.0 mm or greater (top, left)

2. Press  [Copy].
3. Press [ID].
4. Enter the number of copies.
5. Press [Start].
The machine scans one side of the identification card.
6. After the machine has scanned the first side, turn over the identification card.

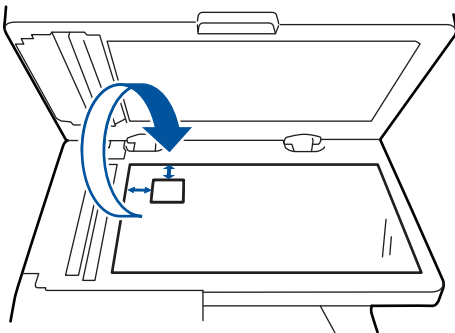

7. Press [Continue] to scan the other side.

Related Information

- [Copy](#)

Copy Options

To change the Copy settings, press  [Options].

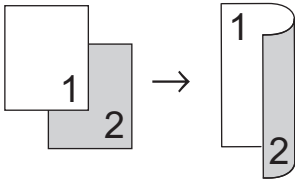
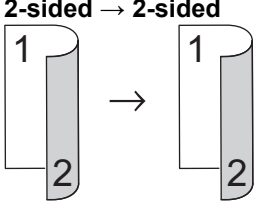
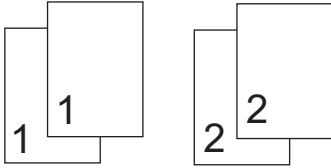
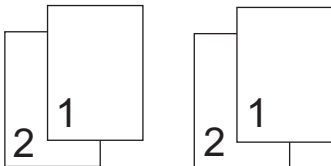
Menu selections	Options	
Quality	Select the copy quality for your type of document.	
Tray Use	Select a paper tray for the next copy.	
Enlarge/Reduce	100%	-
	Enlarge	Select an enlargement ratio for the next copy.
	Reduce	Select a reduction ratio for the next copy.
	Auto	Adjusts the copy size to fit the paper size you have set.
	Custom (25-400%)	Enter an enlargement or reduction ratio.
Density	Increase the density to make the text darker. Decrease the density to make the text lighter.	
2-sided Copy	Select to copy on both sides of the paper. 1-sided → 2-sided  2-sided → 2-sided  The available options will vary depending on your model.	
2-sided Copy Page Layout (Available only under certain settings)	Select long edge binding or short edge binding.	
Contrast	Increase the contrast to make an image clearer. Decrease the contrast to make an image more subdued.	
Stack/Sort	Select to stack or sort multiple copies. Stack  Sort 	

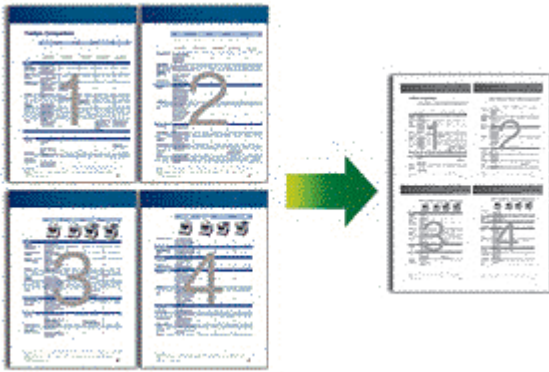
Menu selections	Options
Page Layout	<p>Make N in 1 copies.</p> <p>4 in 1</p> 
Auto Deskew	Set the machine to automatically correct skewed copies.



Related Information

- [Copy](#)

Fax

Related Models: MFC-L5718DN/MFC-L5728DW

- [Send a Fax](#)
- [Receive a Fax](#)
- [Voice Operations and Fax Numbers](#)
- [Telephone Services and External Devices](#)
- [Fax Reports](#)
- [PC-FAX](#)

Send a Fax

Related Models: MFC-L5718DN/MFC-L5728DW

- [Send a Fax](#)
- [Send a 2-sided Fax from the ADF](#)
- [Send a Fax Manually](#)
- [Send a Fax at the End of a Conversation](#)
- [Set the Fax Logic \(Sending and Receiving Sequence\)](#)
- [Send the Same Fax to More than One Recipient \(Broadcasting\)](#)
- [Send a Fax at a Specified Time \(Delayed Fax\)](#)
- [Cancel a Fax in Progress](#)
- [Check and Cancel a Pending Fax](#)
- [Fax Options](#)

Send a Fax

Related Models: MFC-L5718DN/MFC-L5728DW

1. Do one of the following:

- Place the document *face up* in the ADF.
(If you are faxing multiple pages, we recommend using the ADF.)

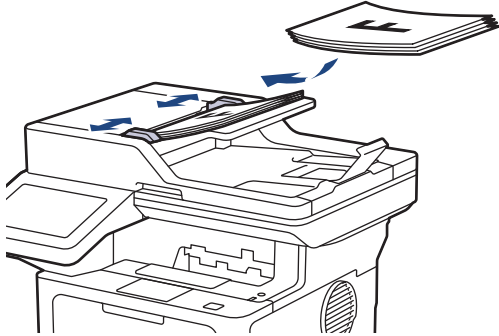

- Place the document *face down* on the scanner glass.

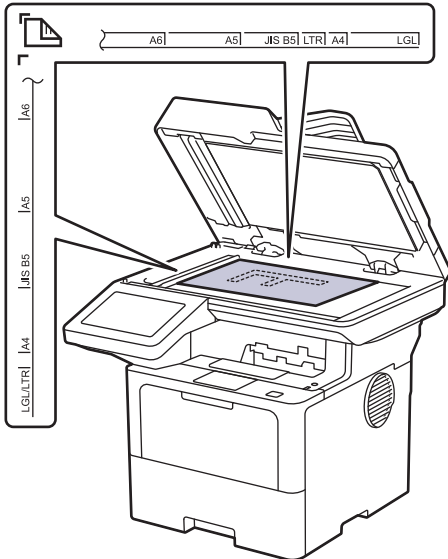

2. Press  [Fax].



If the Fax Preview option is set to [On], press  [Fax] > [Sending Faxes].

3. Enter the fax number.

- Using the dial pad**

Press the digits to enter the fax number.



- Using the Address Book**

Press  [Address Book], and then do one of the following:

- Swipe up or down or press ▲ or ▼ to display the number you want, and then press it.
- Press  [Search], and then enter the name or the first letter of the name and press [OK]. Press the name you want to dial.

When finished, press [Apply].

- **Using the Call History**

Press  [Call History], and then press the [Outgoing Call] option.

Swipe up or down or press ▲ or ▼ to display the fax number you want, and then press it.

To send a fax, press [Apply].

4. Press [Fax Start].

The machine scans and sends the document.

If you placed the document on the scanner glass, follow the instructions in the table.

Option	Description
Yes	To scan the next page, press the Yes option, and then place the next page on the scanner glass. Press OK to scan the page.
No	After you have scanned the last page, press the No option. The machine sends the document.

To stop faxing, press , and then press .

When the LCD displays [Cancel Job?], press [Yes].

Related Information

- [Send a Fax](#)

Send a 2-sided Fax from the ADF

Related Models: MFC-L5718DN/MFC-L5728DW

You must select a 2-sided scanning format before sending a 2-sided fax. Select either the Long Edge or Short Edge option, depending on the layout of your document.

1. Load your document.

2. Press  [Fax].



If the Fax Preview option is set to [On], press  [Fax] > [Sending Faxes].

3. Press  [Options] > [2-sided Fax].

4. Do one of the following:

- If your document is flipped on the long edge, press the [2-sided Scan: Long Edge] option.
- If your document is flipped on the short edge, press the [2-sided Scan: Short Edge] option.

5. Press [OK]. (If the [OK] button is displayed.)

6. Enter the fax number.

7. Press [Fax Start].



Related Information

- [Send a Fax](#)

Send a Fax Manually

Related Models: MFC-L5718DN/MFC-L5728DW

Manual fax transmission lets you hear the dialling, ringing and fax-receiving tones while sending a fax.

1. Load your document.
2. Press  [Fax].



If the Fax Preview option is set to [On], press  [Fax] > [Sending Faxes].

3. Press [Hook] and listen for a dial tone.
4. Dial the fax number you want to call.
5. When you hear the fax tone, press [Fax Start].
If you are using the scanner glass, press [Send].



Related Information

- [Send a Fax](#)

Send a Fax at the End of a Conversation

Related Models: MFC-L5718DN/MFC-L5728DW

At the end of a conversation, you can send a fax to the other party before you both hang up.

1. Ask the other party to wait for fax tones (beeps) and then to press the Start button before hanging up.
2. Load your document.
3. Press [Fax Start].
If you are using the scanner glass, press [Send].
4. Replace the handset.



Related Information

- [Send a Fax](#)

Set the Fax Logic (Sending and Receiving Sequence)

Related Models: MFC-L5718DN/MFC-L5728DW

You can change the process of manual fax send or receive.

If you often send or receive a fax manually to/from the other party at the end of a conversation, set the [Fax Mode] to [Easy Mode].



If you set to [Easy Mode]: You can send or receive a fax manually just simply press [Fax Start]. If you are a caller, press [Fax Start] to send a fax. If you are a receiver, press [Fax Start] to receive a fax.

If you set to [Advanced Mode]: No matter you are a caller or receiver, you can select you will send or receive a fax manually. When you press [Fax Start], the machine will ask you: [Send/Receive?]. If you want to send a fax, select [Send]. If you want to receive a fax, select [Receive].



Even if you set either [Easy Mode] or [Advanced Mode] and if there is a document in the ADF, the document in the ADF will be sent by pressing **Start**.

Even if you set either [Easy Mode] or [Advanced Mode] and if there is a document in the ADF, the document in the ADF will be sent by pressing [Fax Start].

1. Press  [Settings] > [All Settings] > [Fax] > [Miscellaneous] > [Fax Mode].
2. Press [Easy Mode] or [Advanced Mode].
3. Press .



Related Information

- [Send a Fax](#)

Send the Same Fax to More than One Recipient (Broadcasting)

Related Models: MFC-L5718DN/MFC-L5728DW

Use the Broadcasting feature to send the same fax to multiple fax numbers at the same time.





If you did not use any of the Address Book numbers for Groups, you can broadcast faxes to the maximum number of locations supported by your machine. For information about the broadcasting locations, see *Related Information: Specifications*.

1. Load your document.

2. Press  [Fax].



If the Fax Preview option is set to [On], press  [Fax] > [Sending Faxes].

3. Press  [Options] > [Broadcasting].

4. Press [Add Number].

You can add numbers to the broadcast in the following ways:

- Press [Add Number] and enter a number using the LCD.
Press [OK].



If you want to broadcast using an email address, press , enter the email address, and press [OK].

(On certain models, you must download Internet Fax to use the Internet Fax feature and the Scan to Email server feature.)

- Press [Add from Address book]. Swipe up or down or press ▲ or ▼ to display the number you want to add to the broadcast. Select the checkboxes of the broadcast. After you select all the numbers you want, press [OK].
- Press [Search in Address book]. Press the name and press [OK]. Press the name or the first letter of the name, and then press the number you want to add.

5. When finished, press [OK].

6. Press [Fax Start].



- The machine's available memory will vary depending on the types of jobs in the memory and the numbers used for broadcasting. If you broadcast to the maximum number available, you will not be able to use dual access and delayed fax.
- If the [Out of Memory] message appears, press  or [Quit] to stop the job. If more than one page has been scanned, press [Send Now] to send the portion that is in the machine's memory.



Related Information

- [Send a Fax](#)
 - [Cancel a Broadcast in Progress](#)



Related Topics:

- [Specifications](#)

Cancel a Broadcast in Progress

Related Models: MFC-L5718DN/MFC-L5728DW

While broadcasting multiple faxes, you can cancel just the fax currently being transmitted or cancel the whole broadcast job.

1. Press .
2. Press .
3. Do one of the following:
 - To cancel the entire broadcast, press [Entire Broadcast].
When the LCD displays [Cancel Job?], press [Yes].
 - To cancel the current job, press the name or number being dialled on the LCD.
When the LCD displays [Cancel Job?], press [Yes].
 - To exit without cancelling, press .

Related Information

- [Send the Same Fax to More than One Recipient \(Broadcasting\)](#)

Send a Fax at a Specified Time (Delayed Fax)



Related Models: MFC-L5718DN/MFC-L5728DW

You can store up to 50 faxes in the machine's memory to be sent within the next twenty-four hour period.

1. Load your document.
2. Press  [Fax].



If the Fax Preview option is set to [On], press  [Fax] > [Sending Faxes].

3. Press  [Options] > [Delayed Fax] > [Delayed Fax].
4. Press [On].
5. Press [Set Time].
6. To enter the time you want the fax to be sent, do one of the following:
 - If you set [12h Clock] in the [Clock Type] setting, enter the time in 12-hour format. Press [AM] or [PM], and then press [OK].
 - If you set [24h Clock] in the [Clock Type] setting, enter the time in 24-hour format and then press [OK].
(For example, enter 19:45 for 7:45 PM.)
7. Press [OK].
8. Enter the fax number.
9. Press [Fax Start].
10. Press .





Related Information

- [Send a Fax](#)

Cancel a Fax in Progress

Related Models: MFC-L5718DN/MFC-L5728DW

1. Press .
2. Press  while the machine is dialling or sending a fax.
The LCD displays [Cancel Job?].
3. Press an option in the table to cancel or continue the fax job in progress.

Option	Description
Yes	The machine cancels sending the fax job.
No	The machine does not cancel the fax job.



Related Information

- [Send a Fax](#)

Check and Cancel a Pending Fax

Related Models: MFC-L5718DN/MFC-L5728DW

You can cancel a fax job before it is sent, while it is stored in the memory.

1. Press  [Settings] > [All Settings] > [Fax] > [Remaining Jobs].
2. Swipe up or down or press ▲ or ▼ to scroll through the waiting jobs, and then press the job you want to cancel.
3. Press [Cancel].
4. Press [Yes] to cancel the fax job or press [No] to exit without cancelling.
5. When finished, press .

Related Information

- [Send a Fax](#)

Fax Options

Related Models: MFC-L5718DN/MFC-L5728DW

To change the fax-sending settings, press  [Options].

Option	Description
Fax Resolution	Set the resolution for outgoing faxes. The fax quality often can be improved by changing the Fax Resolution.
Contrast	Adjust the contrast. If your document is very light or very dark, changing the contrast may improve the fax quality.
2-sided Fax	Set the 2-sided scanning format.
Glass Scan Size	Adjust the scan area of the scanner glass to the size of the document.
Broadcasting	Send the same fax message to more than one fax number at the same time.
Preview	Preview a fax message before you send it.
Delayed Fax	Set the time of day the delayed faxes will be sent.
Overseas Mode	Set to On if you have difficulty sending faxes overseas.
Call History	Select a number from the Call History.
Address Book	Select a number from the Address Book.
Set New Default	Save your settings as the default.
Factory Reset	Restore all settings back to the factory settings.



You can save the current settings by pressing [Save as Shortcut].



Related Information

- [Send a Fax](#)

Receive a Fax

Related Models: MFC-L5718DN/MFC-L5728DW

- [Receive Mode Settings](#)

Receive Mode Settings

Related Models: MFC-L5718DN/MFC-L5728DW

- [Receive Modes Overview](#)
- [Choose the Correct Receive Mode](#)
- [Use PC-Fax Receive to Transfer Received Faxes to Your Computer \(Windows only\)](#)
- [Set the Number of Rings Before the Machine Answers \(Ring Delay\)](#)
- [Set Fax Detect](#)
- [Shrink Page Size of an Oversized Incoming Fax](#)
- [Set the 2-sided Printing for Received Faxes](#)
- [Set the Fax Receive Stamp](#)
- [Receive a Fax at the End of a Telephone Conversation](#)

Receive Modes Overview

Related Models: MFC-L5718DN/MFC-L5728DW

Mode	Function	Help
Fax Auto	Each call recognized as fax and send fax signal. However, you can answer the call within the number of rings.	<p>Factory setting of Ring Delay is four. After ringing four times, the fax machine send fax-receiving signals automatically.</p> <p>If your machine is connecting an external answering phone device, and often use it to answer incoming calls, you could set the ring time through four to six times. Within the recommended ringing times, you can use the external answering phone device to answer and talk. ¹</p>
Fax Manual	Machine doesn't recognize each call, only as a common phone call that you need to determine after answering the phone.	<p>Answering the call, or if the caller wants to send you a fax, press Fax Start (under easy mode) to receive faxes.</p> <p>If your machine is connecting an external answering phone device, you can use the external answering phone device to answer and talk. ¹</p>
PC Fax Receive	Machine automatically transfers received faxes to your computer running the PC-Fax software.	<p>The machine will transfer the received fax data to the designated computer and the fax data will not remain in your machine in the PC-Fax mode.</p> <p>Select on or off for the backup print feature when you select PC Fax Receive.</p> <p>Machine will print received faxes if you turn on the backup print setting.</p>



Related Information

- [Receive Mode Settings](#)



¹ If the caller wants to send a fax during a call or the caller sends you a fax call, press **Fax Start** button (under easy mode) or press ***51** on the external answering phone device (you have to turn on the remote codes first.) to give fax receiving signals.

Choose the Correct Receive Mode

Related Models: MFC-L5718DN/MFC-L5728DW

The factory setting of Receive Mode is "Fax Auto". Your machine will automatically receive any faxes that are sent to it. There are three receive modes of this machine as below.

LCD Display	Factory Setting Ring Delay
Fax Auto	Ring Delay: four times
Fax Manual	
PC Fax Receive	

1. Press  [Settings] > [All Settings] > [Fax] > [Setup Receive] > [Receive Mode].
2. Press [Fax Auto], [Fax Manual], or [PC Fax Receive].
3. Press .



Related Information

- [Receive Mode Settings](#)

Use PC-Fax Receive to Transfer Received Faxes to Your Computer (Windows only)

Related Models: MFC-L5718DN/MFC-L5728DW

Turn the PC-Fax Receive feature on to automatically store incoming faxes to your machine's memory, and then send them to your computer. Use your computer to view and store these faxes.

To transfer the received faxes to your computer you must have the PC-FAX Receiving software running on your computer.

Even if you have turned computer off (at night or on the weekend, for example), your machine will receive and store your faxes in its memory.

When you start your computer and the PC-FAX Receiving software runs, your machine transfers your faxes to your computer automatically.

If you selected [Backup Print: On], the machine will also print the fax.

1. Press  [Settings] > [All Settings] > [Fax] > [Setup Receive] > [Receive Mode] > [PC Fax Receive].
2. Press [On].
3. Press [OK], and then follow the instructions on the LCD.



- PC-Fax Receive is not available for macOS.
- If you get an error message and the machine cannot print the faxes in the memory, you can use this setting to transfer your faxes to your computer.

4. Press [<USB>] or the name of the computer you want to receive faxes if you are on a network, and then press [OK].
5. Press [Backup Print: On] or [Backup Print: Off].
6. Press .



Related Information

- [Receive Mode Settings](#)

Set the Number of Rings Before the Machine Answers (Ring Delay)

Related Models: MFC-L5718DN/MFC-L5728DW

When somebody calls your machine, you will hear the normal telephone ring sound. The number of rings is set in the Ring Delay option.

- The Ring Delay setting sets the number of times the machine rings before it answers in the Fax Auto Mode.
- If you have external or extension telephones on the same line as the machine, choose the maximum number of rings.

1. Press  [Settings] > [All Settings] > [Fax] > [Setup Receive] > [Ring Delay].
2. Press the number of rings you want.



If you select [0], the machine will answer immediately and the line will not ring at all (available only for some countries).

3. Press .



Related Information

- [Receive Mode Settings](#)

Set Fax Detect

Related Models: MFC-L5718DN/MFC-L5728DW



If Fax Detect is On: The machine receives a fax call automatically, even if you answer the call. When you see [Receiving] on the LCD or when you hear “chirps” through the handset you are using, just replace the handset. Your machine will do the rest.

If Fax Detect is Off: If you are at the machine and answer a fax call by lifting the handset, press the buttons in the following table to receive the fax. If you answered at an extension or external telephone, press *51.

Applicable Models	To receive a fax
MFC-L5718DN/MFC-L5728DW	Fax Start > Receive



- If this feature is set to [On], but your machine does not connect a fax call when you lift an extension or external telephone handset, press the remote activation code *51.
- If you send faxes from a computer on the same telephone line and the machine intercepts them, set Fax Detect to [Off].

1. Press  [Settings] > [All Settings] > [Fax] > [Setup Receive] > [Fax Detect].
2. Press [On] or [Off].
3. Press .





Related Information

- [Receive Mode Settings](#)

Shrink Page Size of an Oversized Incoming Fax

Related Models: MFC-L5718DN/MFC-L5728DW

If you enable the auto reduction function, the machine reduces each page of an incoming fax to fit on your paper. The machine calculates the reduction ratio by using the fax page size and your Paper Size setting.

1. Press  [Settings] > [All Settings] > [Fax] > [Setup Receive] > [Auto Reduction].
2. Press [On] or [Off].
3. Press .

Related Information



- [Receive Mode Settings](#)

Set the 2-sided Printing for Received Faxes

Related Models: MFC-L5718DN/MFC-L5728DW

Your machine prints received faxes on both sides of the paper when [2-sided] is set to [On].

- Use A4 size paper (60 to 105 g/m²) for this function.
- When 2-sided printing is enabled, incoming faxes are automatically reduced to fit the paper in the paper tray.

1. Press  [Settings] > [All Settings] > [Fax] > [Setup Receive] > [2-sided].
2. Press [On] or [Off].
3. Press .

Related Information



- [Receive Mode Settings](#)

Set the Fax Receive Stamp

Related Models: MFC-L5718DN/MFC-L5728DW

You can set the machine to print the received date and time at the top centre of each received fax page.

- Make sure you have set the current date and time on the machine.
- The received time and date will not appear when using Internet Fax.

1. Press  [Settings] > [All Settings] > [Fax] > [Setup Receive] > [Fax Rx Stamp].
2. Press [On] or [Off].
3. Press .

Related Information

- [Receive Mode Settings](#)

Receive a Fax at the End of a Telephone Conversation

Related Models: MFC-L5718DN/MFC-L5728DW

If you are speaking on the telephone connected to your machine and the other party is also speaking on a telephone connected to his fax machine, at the end of the conversation, the other party can send you a fax before you both hang up.

Your machine's ADF must be empty.

1. Ask the other party to place the document in their machine and to press Start or Send.
2. When you hear the CNG tones (slowly repeating beeps), press [Fax Start].



If the machine is in Automatic Redial, wait until it is finished and try again.

3. When you set the [Fax Mode] option to [Advanced Mode], Press [Receive] to receive a fax.
4. Replace the external handset.



Related Information

- [Receive Mode Settings](#)

Voice Operations and Fax Numbers

Related Models: MFC-L5718DN/MFC-L5728DW

- [Voice Operations](#)
- [Store Fax Numbers](#)
- [Set up Broadcasting Groups](#)
- [Combine Address Book Numbers](#)

Voice Operations

- [Send Tone Signals](#)

Send Tone Signals

Related Models: MFC-L5718DN/MFC-L5728DW

If you have a Pulse dialling service, but must send Tone signals (for example, for telephone banking), follow these steps. If you have a Touch Tone service, you will not need this feature to send tone signals.

1. Press  [Fax].



If the Fax Preview option is set to [On], press  [Fax] > [Sending Faxes].

2. Press [Hook].
3. Press # on the machine's LCD.

Any digits dialled after this will send tone signals.

When you are finished with the call, the machine will return to the Pulse dialling service.



Related Information

- [Voice Operations](#)

Store Fax Numbers

Related Models: MFC-L5718DN/MFC-L5728DW

- [Store Address Book Numbers](#)
- [Change or Delete Address Book Names or Numbers](#)

Store Address Book Numbers

Related Models: MFC-L5718DN/MFC-L5728DW

1. Press  [Fax] > [Address Book].
2. Do the following steps:
 - a. Press [Edit].
 - b. Press [Add New Address].
 - c. Press [Name].
 - d. Enter the name using the LCD (up to 16 characters), and then press [OK].
 - e. Press [pinyin].
 - f. Enter the pinyin using the LCD (up to 16 characters), and then press [OK].
 - g. Press [Address].
 - h. Enter the fax or telephone number using the LCD (up to 20 digits), and then press [OK].



To store an email address to use with Internet Fax or Scan to Email server, press  and enter the email address and press [OK].

- i. Press [OK].

To store another Address Book number, repeat these steps.

3. Press .



Related Information

- [Store Fax Numbers](#)
- [Save Outgoing Call Numbers to the Address Book](#)

Save Outgoing Call Numbers to the Address Book

Related Models: MFC-L5718DN/MFC-L5728DW

You can copy numbers from your Outgoing Call history and save them in your Address Book.

1. Press  [Fax] > [Call History] > [Outgoing Call].
2. Swipe up or down or press ▲ or ▼ to display the number you want, and then press it.
3. Press [Edit] > [Add to Address Book] > [Name].



To delete the number, press [Edit] > [Delete]. Press [Yes] to confirm.

4. Enter the name using the LCD (up to 16 characters).
5. Press [OK].
6. Press [OK] to confirm the fax or telephone number you want to store.
7. Press .



Related Information

- [Store Address Book Numbers](#)

Change or Delete Address Book Names or Numbers

Related Models: MFC-L5718DN/MFC-L5728DW

1. Press  [Fax] > [Address Book] > [Edit].
2. Do one of the following:
 - Press [Change] to edit the names or fax or telephone numbers.
 - Swipe up or down or press ▲ or ▼ to display the number you want to change, and then press it.
 - To change the name, press [Name]. Enter the new name (up to 16 characters) using the LCD, and then press [OK].
 - To change the fax or telephone number, press [Address]. Enter the new fax or telephone number (up to 20 digits) using the LCD, and then press [OK].Press [OK] to finish.



How to enter text:

To change a character, press ◀ or ▶ to position the cursor to highlight the incorrect character, and then press .

Enter the new character.

To delete numbers, press [Delete].

Select the fax or telephone numbers you want to delete by pressing them to display a check mark, and then press [OK].

3. Press .



Related Information

- [Store Fax Numbers](#)

Set up Broadcasting Groups

Related Models: MFC-L5718DN/MFC-L5728DW

A broadcasting group can be stored in the Address Book. It allows you to send the same fax message to many fax numbers.

Store fax numbers in the Address Book and add them to a broadcasting group as needed.

Applicable Models	Maximum number of groups	Maximum numbers in a group
MFC-L5718DN/MFC-L5728DW	20	299

1. Press  [Fax] > [Address Book].
2. Do the following steps:
 - a. Press [Edit] > [Setup Groups] > [Name].
 - b. Enter the Group name (up to 16 characters) using the LCD, and then press [OK].
 - c. Press [Add/Delete].
 - d. Add Address Book numbers to the Group by pressing them to display a check mark, and then press [OK].
 - e. Read and confirm the displayed list of names and numbers you have chosen, and then press [OK] to save your Group.

To store another Group for broadcasting, repeat these steps.

3. Press .

Related Information

- [Voice Operations and Fax Numbers](#)
 - [Change a Broadcasting Group Name](#)
 - [Delete a Broadcasting Group](#)
 - [Add or Delete a Broadcasting Group Member](#)

Change a Broadcasting Group Name

Related Models: MFC-L5718DN/MFC-L5728DW

1. Press  [Fax] > [Address Book] > [Edit] > [Change].
2. Swipe up or down or press ▲ or ▼ to display the Group you want, and then press the Group name.
3. Press [Name].
4. Enter the new Group name (up to 16 characters) using the LCD, and then press [OK].



How to change the stored name:

To change a character, press ◀ or ▶ to position the cursor to highlight the incorrect character, and then press .

Enter the new character.

5. Press [OK].
6. Press .





Related Information

- [Set up Broadcasting Groups](#)

Delete a Broadcasting Group

Related Models: MFC-L5718DN/MFC-L5728DW



1. Press  [Fax] > [Address Book] > [Edit] > [Delete].
2. Swipe up or down or press ▲ or ▼ to display the Group you want, and then press the Group name.
3. Press [OK].
4. Press .

Related Information

- [Set up Broadcasting Groups](#)

Add or Delete a Broadcasting Group Member

Related Models: MFC-L5718DN/MFC-L5728DW

1. Press  [Fax] > [Address Book] > [Edit] > [Change].
2. Swipe up or down or press ▲ or ▼ to display the Group you want, and then press the Group name.
3. Swipe up or down or press ▲ or ▼ to display the [Add/Delete] option, and then press [Add/Delete].
4. Swipe up or down or press ▲ or ▼ to display the number you want to add or delete.
5. Do the following for each number you want to change:
 - To add a number to the Group, press the checkbox of the number to add a check mark.
 - To delete a number from the Group, press the checkbox of the number to remove the check mark.
6. Press [OK].
7. Press [OK].
8. Press .



Related Information

- [Set up Broadcasting Groups](#)

Combine Address Book Numbers

Related Models: MFC-L5718DN/MFC-L5728DW



Sometimes you may want to choose from several long-distance carriers when you send a fax. Rates may vary depending on the time and destination.

You can store these long dialling sequences by dividing them and setting them up as separate Address Book numbers in any combination. You can even include manual dialling using the dial pad.

For example: You might have stored '01632' and '960555' in your machine as shown in the following table.

Applicable Models	'01632' stored in	'960555' stored in
MFC-L5718DN/MFC-L5728DW	Address Book: Brother 1	Address Book: Brother 2

You can use them both to dial '01632-960555' by using the following procedure.

1. Press  [Fax] > [Address Book].
2. Swipe up or down or press ▲ or ▼ to display the number of Brother 1.
3. Press the number.
4. Press [Apply].
5. Press  [Options].
6. Press ▲ or ▼ to display the [Address Book] option, and then press it.
7. Press [OK].
8. Swipe up or down or press ▲ or ▼ to display the number of Brother 2.
9. Press the number.
10. Press [Apply].
11. Press [Fax Start].

The machine will dial '01632-960555'.

To temporarily change a number, you can substitute part of the number by pressing it using the LCD. For example, to change the number to '01632-960556', you could enter the number (Brother 1: 01632) using the Address Book, press [Apply], and then enter 960556 using the LCD.



If you must wait for another dial tone or signal at any point in the dialling sequence, create a pause in the number by pressing [Pause].

Related Information

- [Voice Operations and Fax Numbers](#)

Telephone Services and External Devices

Related Models: MFC-L5718DN/MFC-L5728DW

- [External and Extension Telephones](#)
- [Multi-line Connections \(PABX\)](#)

External and Extension Telephones

Related Models: MFC-L5718DN/MFC-L5728DW

- [Connect an External or Extension Telephone](#)
- [Operation from External and Extension Telephones](#)
- [Use the Remote Codes](#)

Connect an External or Extension Telephone

Related Models: MFC-L5718DN/MFC-L5728DW

You can connect a separate telephone to your machine as shown in the diagram below.

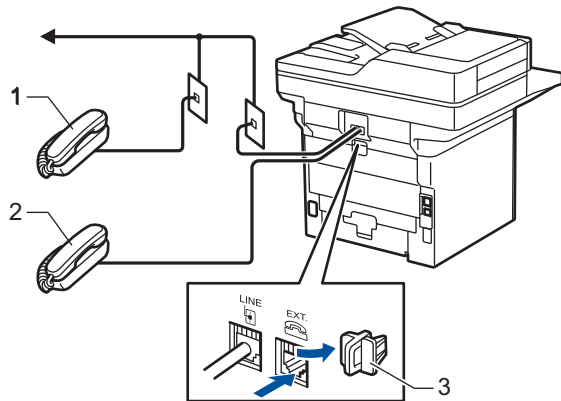

- 1 Extension telephone
- 2 External telephone
- 3 Protective Cap



Related Information

- [External and Extension Telephones](#)

Operation from External and Extension Telephones

Related Models: MFC-L5718DN/MFC-L5728DW

If you answer a fax call at an extension or an external telephone, you can make your machine take the call by using the Remote Activation Code. When you press the Remote Activation Code ***51**, the machine starts to receive the fax.

If the machine answers a voice call and pseudo/double-rings for you to take over, you can take the call at an extension telephone by pressing the Remote Deactivation Code **#51**.

If you answer a call and no one is on the line:

You are receiving a manual fax.

Press ***51** and wait for the chirp or until the LCD displays [Receiving], and then hang up.



You can also use the Fax Detect feature to make your machine automatically take the call.



Related Information

- [External and Extension Telephones](#)

Use the Remote Codes

Related Models: MFC-L5718DN/MFC-L5728DW

Remote Activation Code

If you answer a fax call on an extension or external telephone, you can tell your machine to receive it by pressing the Remote Activation Code *51. Wait for the chirping sounds, and then replace the handset.

If you answer a fax call at the external telephone, you can make the machine receive the fax by pressing the buttons in the following table: (When you set the [Fax Mode] option to [Advanced Mode].)

Applicable Models	To make the machine receive a fax
MFC-L5718DN/MFC-L5728DW	Fax Start and then Receive





Related Information

- [External and Extension Telephones](#)
 - [Change the Remote Codes](#)

Change the Remote Codes

Related Models: MFC-L5718DN/MFC-L5728DW

The preset Remote Activation Code is ***51**. The preset Remote Deactivation Code is **#51**. If you are always disconnected when accessing your external answering phone device remotely, try changing the three-digit remote codes using the numbers 0-9, *, and #.

1. Press  [Settings] > [All Settings] > [Fax] > [Setup Receive] > [Remote Codes].
2. Do one of the following:
 - To change the Remote Activation Code, press [Act. Code]. Enter the new code, and then press [OK].
 - To change the Remote Deactivation Code, press [Deact. Code]. Enter the new code, and then press [OK].
 - If you do not want to change the Codes, go to the next step.
 - To turn off (or turn on) the Remote Codes, press [Remote Codes], and then press [Off] (or [On]).
3. Press .



Related Information

- [Use the Remote Codes](#)

Multi-line Connections (PABX)

Related Models: MFC-L5718DN/MFC-L5728DW

Most offices use a central telephone system.

We recommend that all our machines be connected to a discreet (dedicated) line. Although a particular PABX may appear to work with a particular model of fax machine, we cannot guarantee that the unit will operate correctly.

While it is often relatively simple to connect a fax machine to a PABX, (Private Automatic Branch Exchange), we suggest that you contact the company that installed your telephone system and ask them to connect the fax machine for you.

We do not recommend the use of a PABX line. PABX limitations in general can cause some functions of the fax machine not to work correctly.

Related Information

- [Telephone Services and External Devices](#)

Fax Reports

- [Print a Fax Journal](#)

Print a Fax Journal

Related Models: MFC-L5718DN/MFC-L5728DW

You can set the machine to print a journal at specific intervals.

1. Press  [Settings] > [All Settings] > [Fax] > [Report Setting] > [Journal Period] > [Journal Period].
2. Press [Every 50 Faxes] or [Off].



[Every 50 Faxes]: The machine will print the Journal when the machine has stored 50 reception and transmission log data.

3. Press .



Related Information

- [Fax Reports](#)

PC-FAX

Related Models: MFC-L5718DN/MFC-L5728DW

- [PC-FAX for Windows](#)
- [PC-FAX for Mac\(Sending only\)](#)

PC-FAX for Windows

Related Models: MFC-L5718DN/MFC-L5728DW

- [PC-FAX Overview \(Windows\)](#)
- [Send a Fax Using PC-FAX \(Windows\)](#)
- [Receive Faxes on Your Computer \(Windows\)](#)

PC-FAX Overview (Windows)

Related Models: MFC-L5718DN/MFC-L5728DW

Reduce paper consumption and save time by using the Brother PC-FAX software to send faxes directly from your computer.

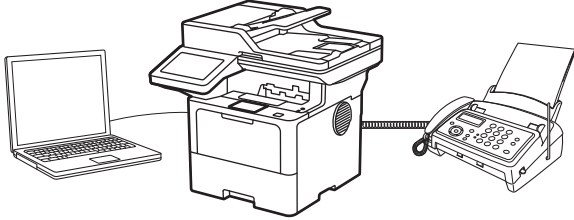

- [Configure PC-FAX \(Windows\)](#)
- [Configure your PC-Fax Address Book \(Windows\)](#)

Configure PC-FAX (Windows)

Related Models: MFC-L5718DN/MFC-L5728DW

Before sending faxes using PC-FAX, personalise the send options in each tab of the **PC-FAX Setup** dialog box.

1. Launch  (**Brother Utilities**), and then click the drop-down list and select your model name (if not already selected).
2. Click **PC-FAX** in the left navigation bar, and then click **Setup Sending**.

The **PC-FAX Setup** dialog box appears.

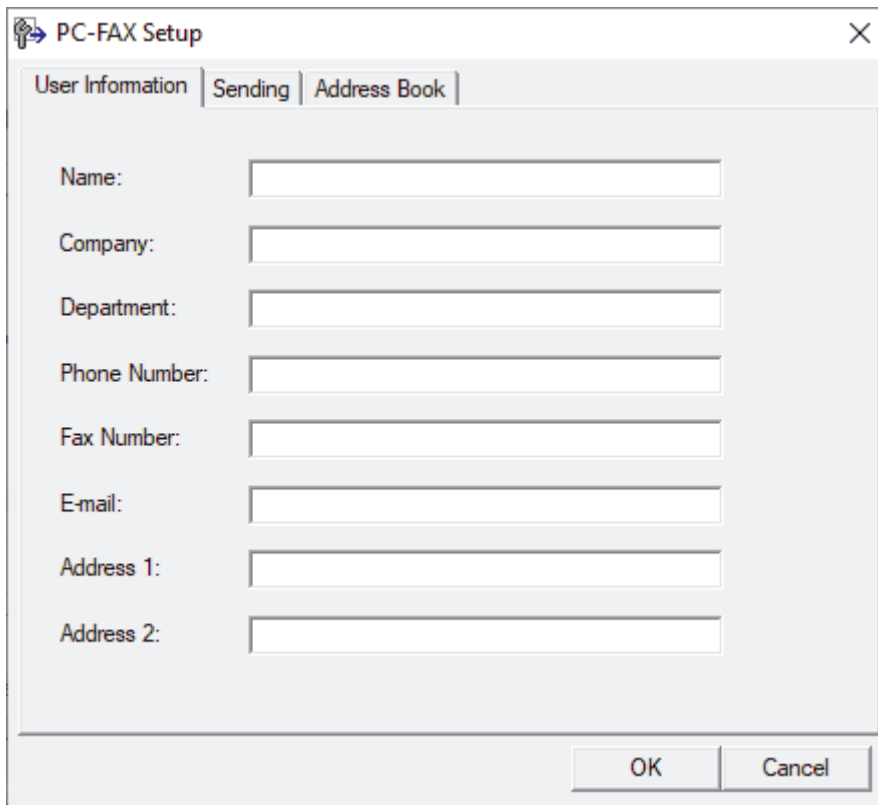

3. Do one of the following:
 - Click the **User Information** tab, and then type your user information in the fields.



Each Microsoft account can have its own customised **User Information** screen for custom fax headers and cover pages.

- Click the **Sending** tab, and then type the number needed to access an outside line (if needed) in the **Outside line access** field. Select the **Include header** check box to include the header information.
- Click the **Address Book** tab, and then select the address book you want to use for PC-FAX from the **Select Address Book** drop-down list.

4. Click **OK**.



Related Information

- [PC-FAX Overview \(Windows\)](#)

Configure your PC-Fax Address Book (Windows)

Related Models: MFC-L5718DN/MFC-L5728DW

Add, edit, and delete members and groups to personalise your **Address Book**.

- [Add a Member to your PC-FAX Address Book \(Windows\)](#)
- [Create a Group in your PC-FAX Address Book \(Windows\)](#)
- [Edit Member or Group Information in your PC-FAX Address Book \(Windows\)](#)
- [Delete a Member or Group in your PC-FAX Address Book \(Windows\)](#)
- [Export your PC-FAX Address Book \(Windows\)](#)
- [Import Information to your PC-FAX Address Book \(Windows\)](#)

Add a Member to your PC-FAX Address Book (Windows)

Related Models: MFC-L5718DN/MFC-L5728DW

Add new people and their fax information to the PC-Fax Address Book if you want to send a fax using the Brother PC-Fax software.

1. Launch  (**Brother Utilities**), and then click the drop-down list and select your model name (if not already selected).
2. Click **PC-FAX** in the left navigation bar, and then click **Address Book (Send)**.

The **Address Book** dialog box appears.

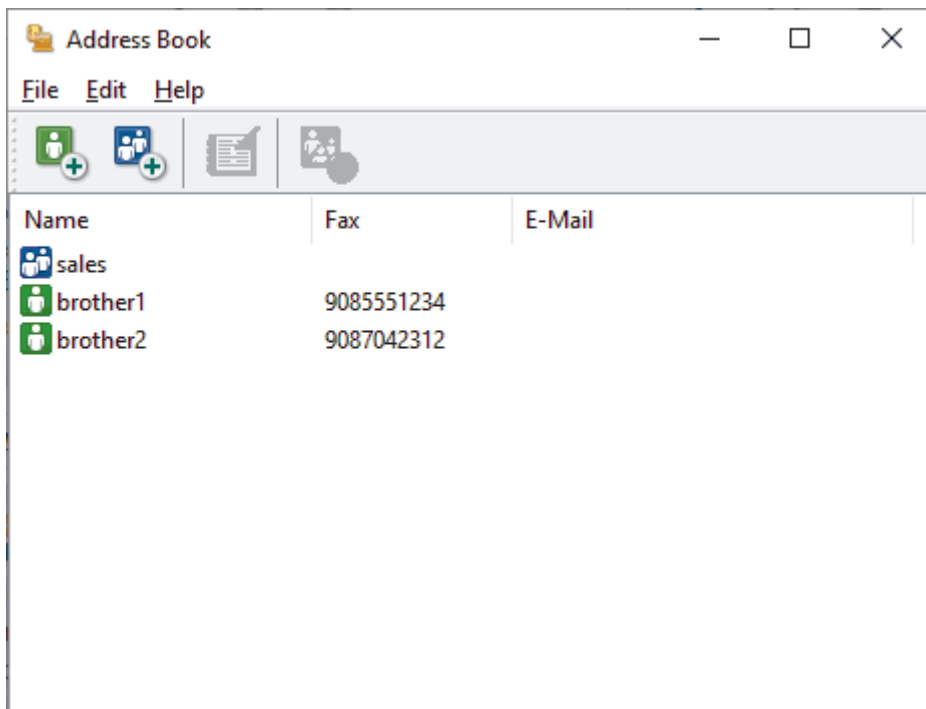

3. Click  to add new members.
The **Address Book Member Setup** dialog box appears.
4. Type the member's information in the corresponding fields. The **Name** field is required.
5. Click **OK**.

Related Information

- [Configure your PC-Fax Address Book \(Windows\)](#)

Create a Group in your PC-FAX Address Book (Windows)

Related Models: MFC-L5718DN/MFC-L5728DW

Create a group to broadcast the same PC-FAX to several recipients at once.

1. Launch  (**Brother Utilities**), and then click the drop-down list and select your model name (if not already selected).
2. Click **PC-FAX** in the left navigation bar, and then click **Address Book (Send)**.

The **Address Book** dialog box appears.

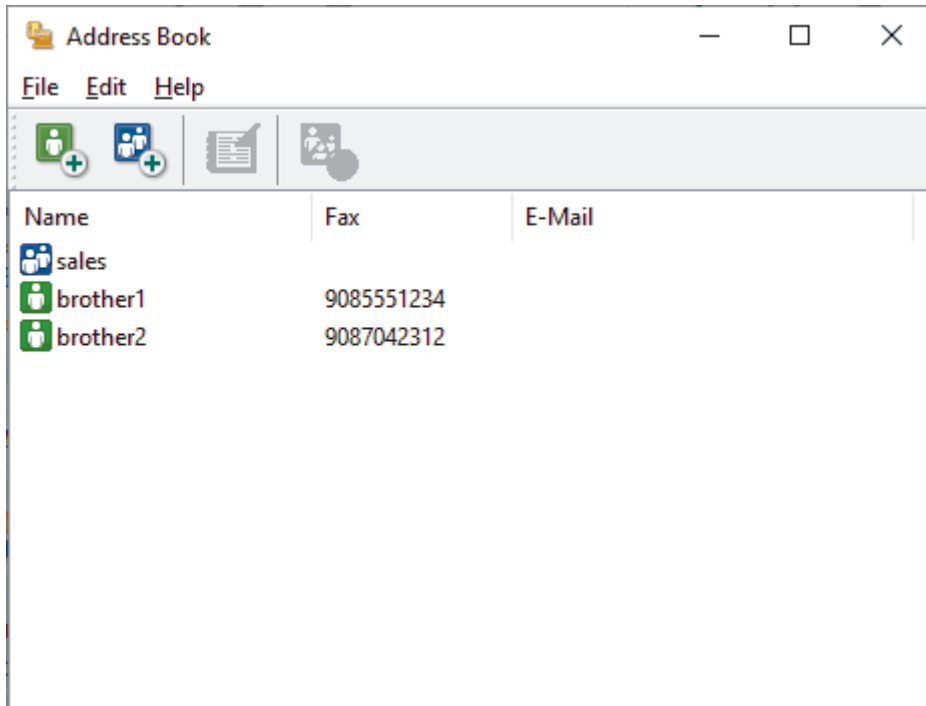

3. Click  to add a new group.

The **Address Book Group Setup** dialog box appears.

4. Type the name of the new group in the **Group Name** field.
5. In the **Available Names** field, select each name you want to include in the group, and then click **Add >>**.
Members added to the group appear in the **Group Members** box.
6. When finished, click **OK**.



Each group can contain up to 50 members.

Related Information

- [Configure your PC-Fax Address Book \(Windows\)](#)

Edit Member or Group Information in your PC-FAX Address Book (Windows)

Related Models: MFC-L5718DN/MFC-L5728DW

1. Launch  (**Brother Utilities**), and then click the drop-down list and select your model name (if not already selected).
2. Click **PC-FAX** in the left navigation bar, and then click **Address Book (Send)**.
The **Address Book** dialog box appears.

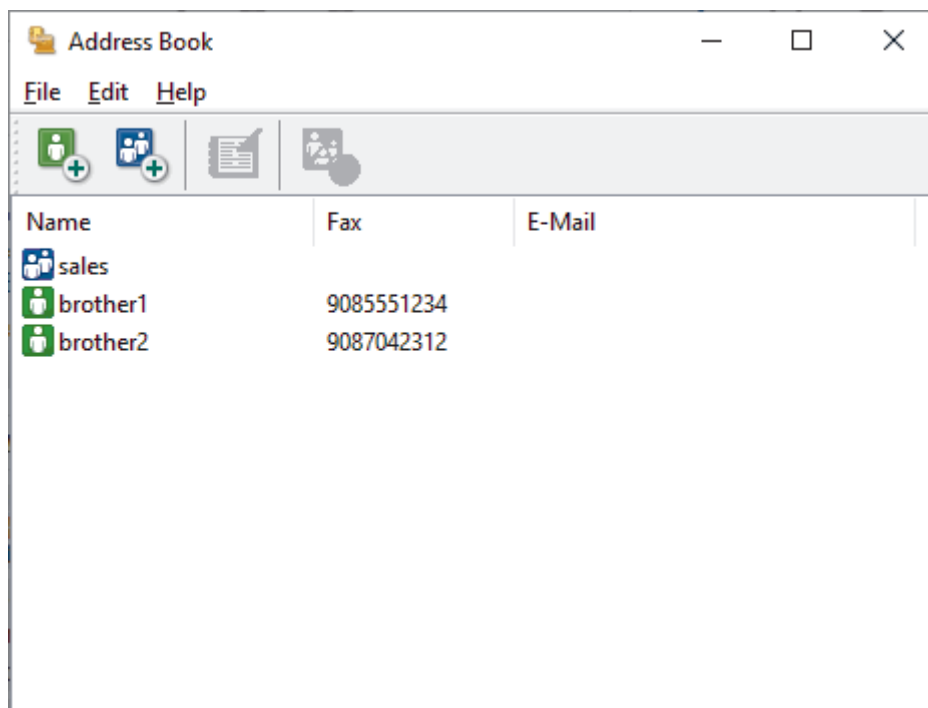

3. Select the member or group you want to edit.
4. Click  (**Properties**).
5. Change the member or group information.
6. Click **OK**.

Related Information

- [Configure your PC-Fax Address Book \(Windows\)](#)

Delete a Member or Group in your PC-FAX Address Book (Windows)

Related Models: MFC-L5718DN/MFC-L5728DW

1. Launch  (**Brother Utilities**), and then click the drop-down list and select your model name (if not already selected).
2. Click **PC-FAX** in the left navigation bar, and then click **Address Book (Send)**.
The **Address Book** dialog box appears.

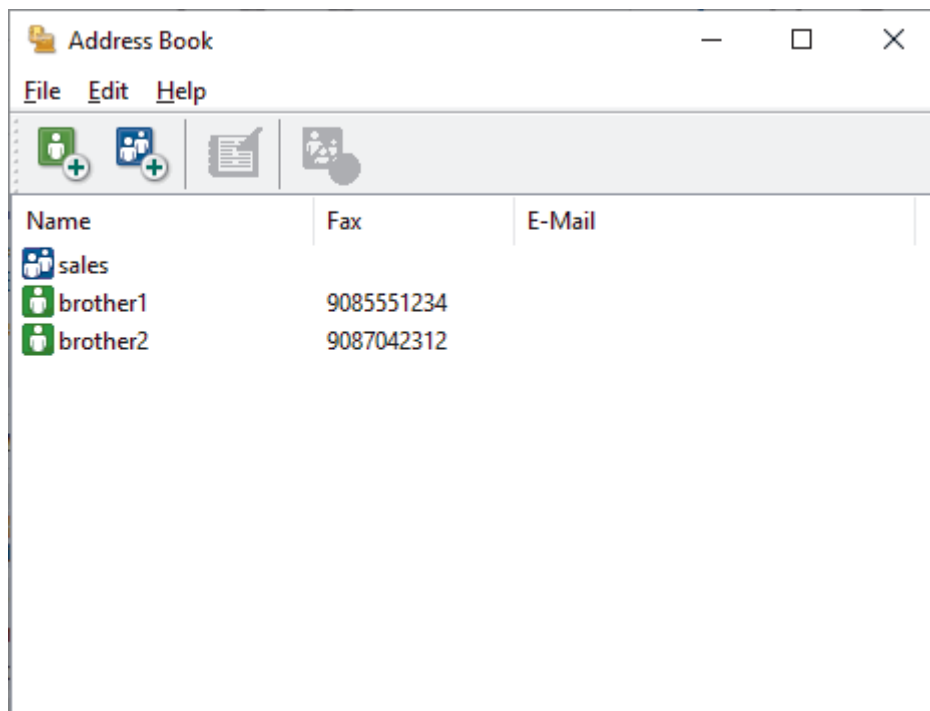

3. Select the member or group you want to delete.
4. Click  (**Delete**).
5. When the confirmation dialog box appears, click **OK**.

Related Information

- [Configure your PC-Fax Address Book \(Windows\)](#)

Export your PC-FAX Address Book (Windows)

Related Models: MFC-L5718DN/MFC-L5728DW

You can export the Address Book as an ASCII text file (*.csv) or a vCard (an electronic business card) and save it on your computer.

You cannot export the group settings when you export the **Address Book** data.

1. Launch  (**Brother Utilities**), and then click the drop-down list and select your model name (if not already selected).
2. Click **PC-FAX** in the left navigation bar, and then click **Address Book (Send)**.

The **Address Book** dialog box appears.

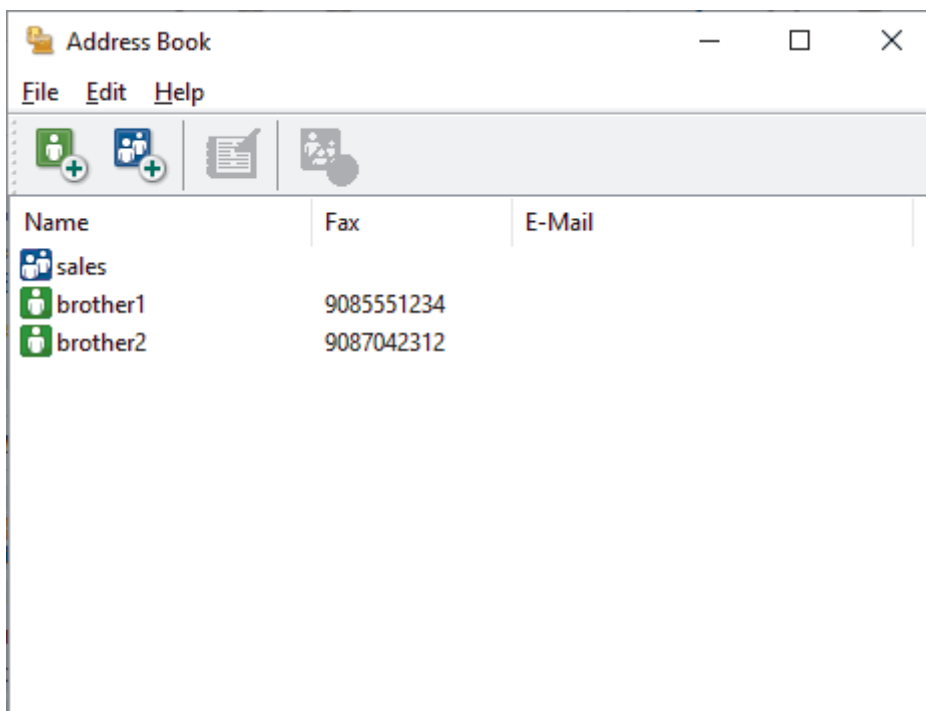

3. Click **File > Export**.
4. Select one of the following:
 - **Text**

The **Select Items** dialog box appears. Go to the next step.
 - **vCard**

You must select the member you want to export from your address book before selecting this option. Browse to the folder where you want to save the vCard, type the vCard name in the **File name** field, and then click **Save**.
5. In the **Available Items** field, select the data you want to export, and then click **Add >>**.



Select and add the items in the order you want them listed.

6. If you are exporting to an ASCII file, under the **Divide Character** section, select the **Tab** or **Comma** option to separate the data fields.
7. Click **OK**.
8. Browse to the folder on your computer where you want to save the data, type the file name, and then click **Save**.



Related Information

- [Configure your PC-Fax Address Book \(Windows\)](#)
-

Import Information to your PC-FAX Address Book (Windows)

Related Models: MFC-L5718DN/MFC-L5728DW

You can import ASCII text files (*.csv) or vCards (electronic business cards) into your Address Book.

1. Launch  (**Brother Utilities**), and then click the drop-down list and select your model name (if not already selected).
2. Click **PC-FAX** in the left navigation bar, and then click **Address Book (Send)**.

The **Address Book** dialog box appears.

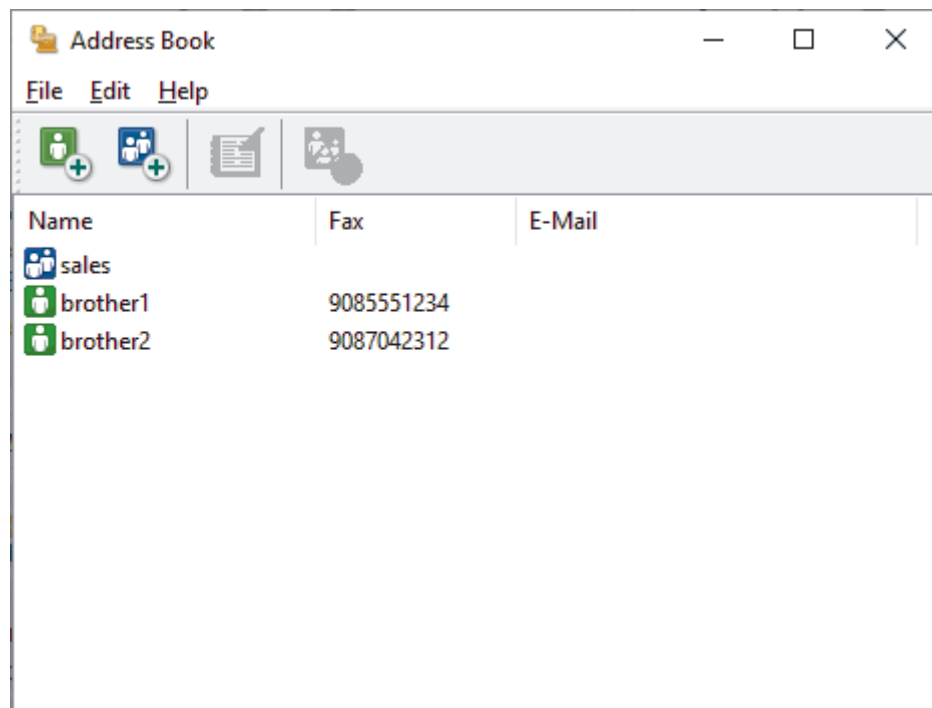

3. Click **File > Import**.
4. Select one of the following:
 - **Text**
The **Select Items** dialog box appears. Go to step 5.
 - **vCard**
Go to step 8.
5. In the **Available Items** field, select the data you want to import, and then click **Add >>**.



You must select and add fields from the **Available Items** list in the same order they are listed in the import text file.

6. If you are importing an ASCII file, under the **Divide Character** section, select the **Tab** or **Comma** option to separate the data fields.
7. Click **OK**.
8. Browse to the folder where you want to import the data, type the file name, and then click **Open**.



Related Information

- [Configure your PC-Fax Address Book \(Windows\)](#)

Send a Fax Using PC-FAX (Windows)

Related Models: MFC-L5718DN/MFC-L5728DW

PC-FAX supports only monochrome faxes. A monochrome fax will be sent even if the original data is in colour and the receiving fax machine supports colour faxes.

1. Create a file in any application on your computer.
2. Select the print command in your application.
3. Select **Brother PC-FAX** as your printer, and then complete your print operation.

The **BrotherPC-FAX** dialog box appears.

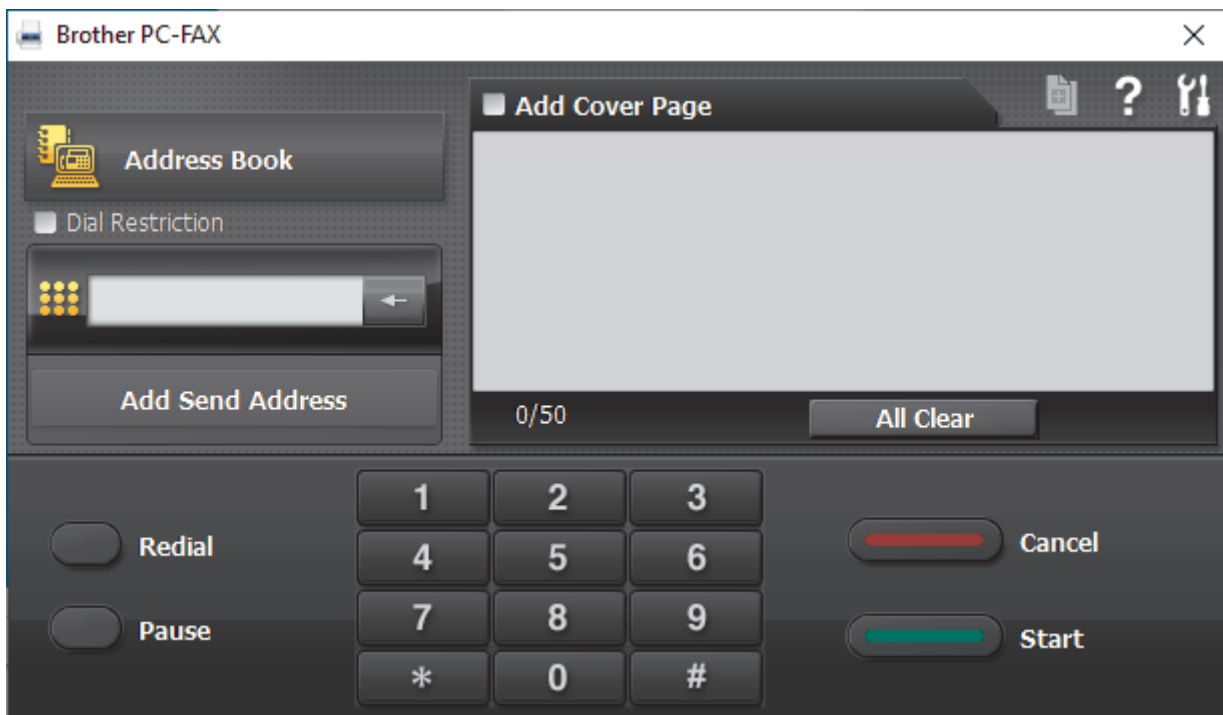

4. Type a fax number using one of the following methods:
 - Click the numbers on the dial pad to type the number, and then click **Add Send Address**.

 If you select the **Dial Restriction** checkbox, a confirmation dialog box will appear for you to re-type the fax number using the keyboard. This feature helps to prevent transmissions to the wrong destination.

- Click the **Address Book** button, and then select a member or group from the Address Book.

 If you make a mistake, click **All Clear** to delete all entries.

5. To include a cover page, select the **Add Cover Page** checkbox. You can also click  to create or edit a cover page.
6. Click **Start** to send the fax.

- To cancel the fax, click **Cancel**.
- To redial a number, click **Redial** to show the last five fax numbers, select a number, and then click **Start**.

Related Information

- [PC-FAX for Windows](#)

Receive Faxes on Your Computer (Windows)

Related Models: MFC-L5718DN/MFC-L5728DW

Use the Brother PC-FAX software to receive faxes on your computer, view them, and print only the faxes you want.

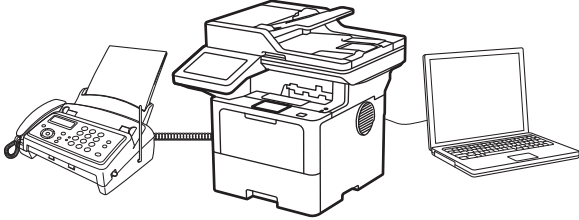

- [Receive Faxes Using PC-FAX Receive \(Windows\)](#)

Receive Faxes Using PC-FAX Receive (Windows)

Related Models: MFC-L5718DN/MFC-L5728DW

The Brother PC-FAX Receive software lets you view and store faxes on your computer. It is automatically installed when you install your machine's software and drivers and works on locally or network-connected machines.

PC-FAX Receive supports only monochrome faxes.

When you turn your computer off, your machine will continue to receive and store faxes in your machine's memory. The machine's LCD will display the number of stored faxes received. When you start this application, the software will transfer all received faxes to your computer at once. You can enable the Backup Print option if you want the machine to print a copy of the fax before the fax is sent to your computer, or before the computer is switched off. You can configure the Backup Print settings from your machine.



Related Information

- [Receive Faxes on Your Computer \(Windows\)](#)
 - [Run Brother PC-FAX Receive on Your Computer \(Windows\)](#)
 - [View Received PC-FAX Messages \(Windows\)](#)

Run Brother PC-FAX Receive on Your Computer (Windows)

Related Models: MFC-L5718DN/MFC-L5728DW

If PC-FAX receiving is disabled on your machine, enable the setting before trying to run PC-FAX Receive. For information on how to enable this function, see *Related Information: Configure PC-FAX Receive Using Web Based Management*.



We recommend selecting the **Start PC-FAX Receive on computer startup** checkbox so that the software runs automatically and transfers any faxes when you turn your computer on.

1. Launch  (**Brother Utilities**), and then click the drop-down list and select your model name (if not already selected).
2. Click **PC-FAX** in the left navigation bar, and then click **Receive**.
3. Confirm the message and click **Yes**.

The **PC-FAX Receive** window appears. The  (**PC-Fax Receive (Ready)**) icon also appears in your computer task tray.



Related Information

- [Receive Faxes Using PC-FAX Receive \(Windows\)](#)
 - [Set Up PC-FAX Receive on Your Computer \(Windows\)](#)
 - [Add Your Machine to PC-FAX Receive Devices \(Windows\)](#)

Related Topics:

- [Configure PC-FAX Receive Using Web Based Management](#)

Set Up PC-FAX Receive on Your Computer (Windows)

Related Models: MFC-L5718DN/MFC-L5728DW

1. Double-click the  (**PC-Fax Receive (Ready)**) icon in your computer task tray.
The **PC-FAX Receive** window appears.
2. Click **Settings**.
3. Configure these options as needed:

Preferences

Configure to start PC-FAX Receive automatically when you start Windows.

Save

Configure the path to save PC-FAX files and select the received document format.

Upload to

Configure the path to the server and select the option to upload automatically or manually (available only for administrators).

Device

Select the machine where you want to receive PC-FAX files.

Lock (available only for administrators)

Restrict users who do not have administrator privileges from configuring the settings options shown above.

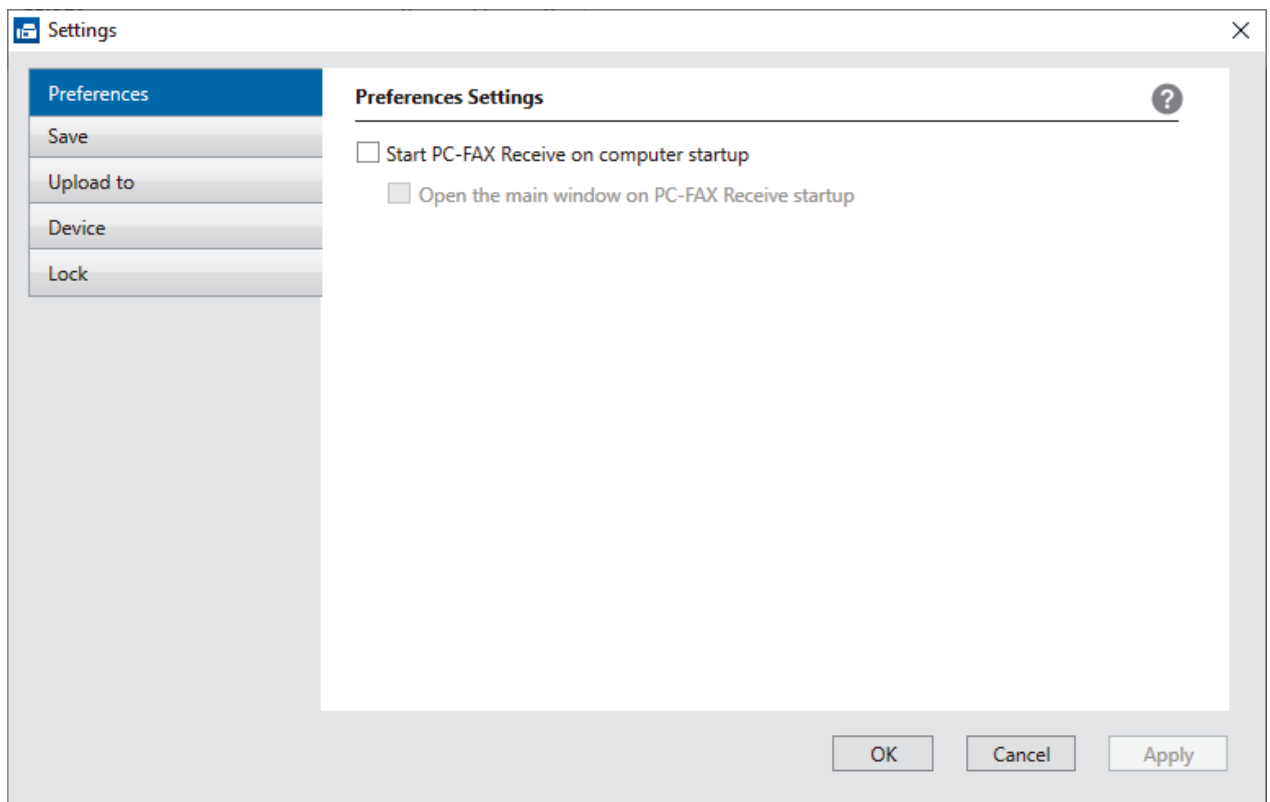

4. Click **OK**.

Related Information

- [Run Brother PC-FAX Receive on Your Computer \(Windows\)](#)

Add Your Machine to PC-FAX Receive Devices (Windows)

Related Models: MFC-L5718DN/MFC-L5728DW

If you installed your machine following the on-screen instructions, the machine should be ready for use.

1. Double-click the  (**PC-Fax Receive (Ready)**) icon in your computer task tray.
The **PC-FAX Receive** window appears.
2. Click **Settings**.
3. Click **Device > Add**.

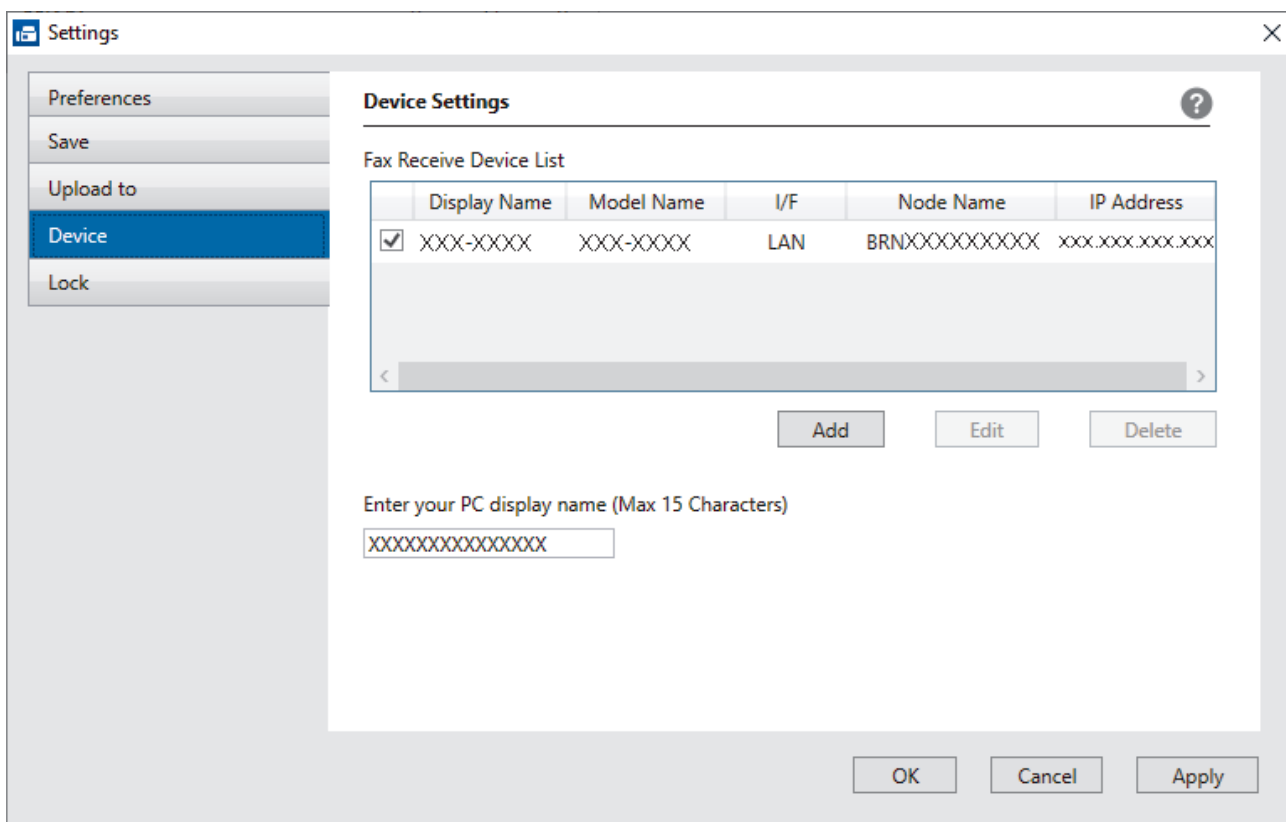

4. Select the correct connection method.
Select your machine from the automatic search results below.
A list of connected machines appears. Select the machine you want. Click **OK**.
Specify your machine by IP address
Type the machine's IP address in the **IP Address** field, and then click **OK**.
5. To change the computer name that will appear on the machine's LCD, type the new name in the **Enter your PC display name (Max 15 Characters)** field.
6. Click **OK**.





Related Information

- [Run Brother PC-FAX Receive on Your Computer \(Windows\)](#)

View Received PC-FAX Messages (Windows)

Related Models: MFC-L5718DN/MFC-L5728DW

Receiving Status

Icon	Status
	Standby mode No unread messages
	Receiving messages
	Messages received Unread messages

1. Double-click the  (PC-Fax Receive (Ready)) icon in your computer task tray.

The **PC-FAX Receive** window appears.

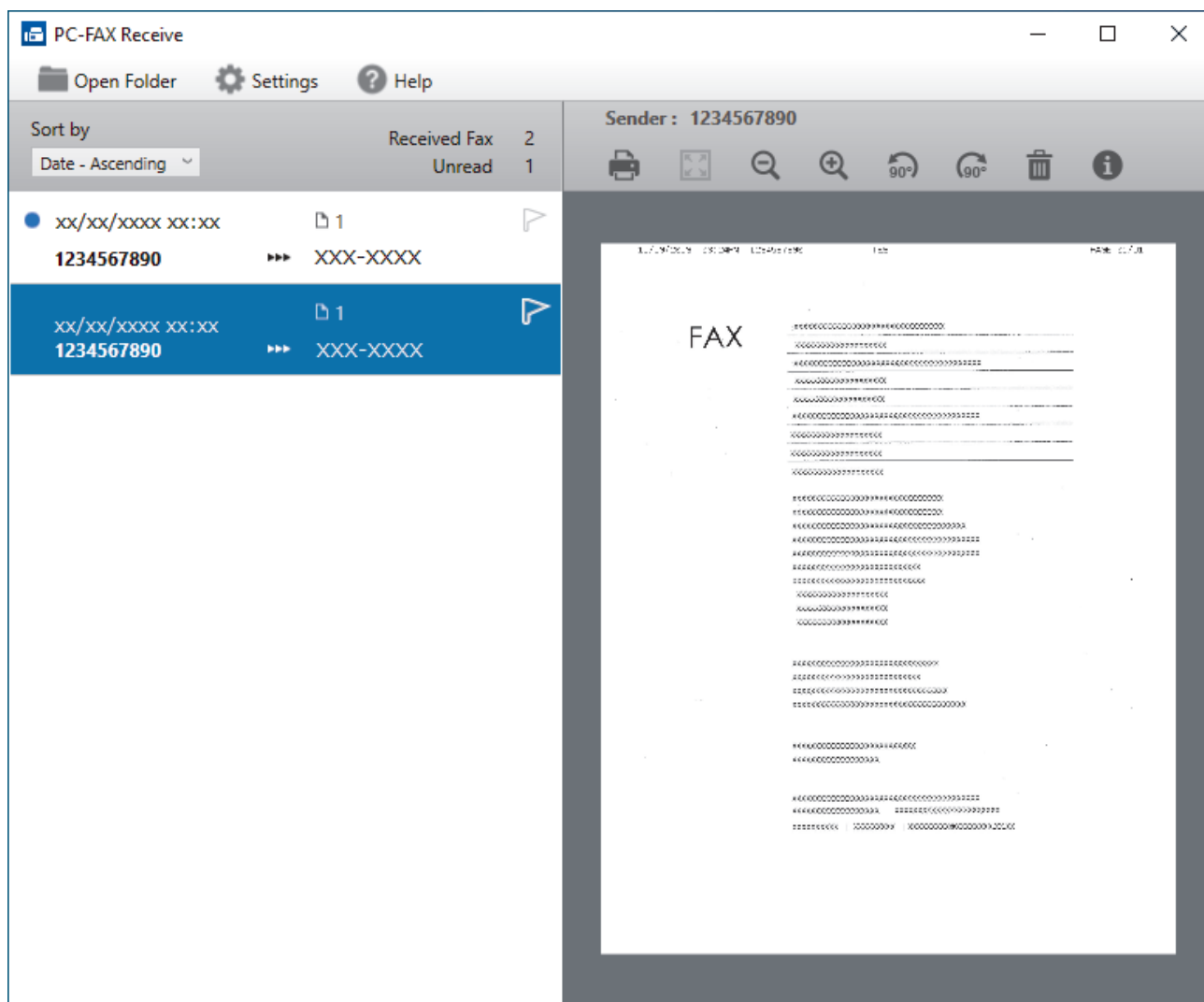

2. Click any faxes in the list to view them.
3. When finished, close the window.



Even after closing the window, PC-FAX Receive is active and the  (PC-Fax Receive (Ready)) icon will remain in your computer task tray. To close PC-FAX Receive, click the icon in the computer task tray and click **Close**.



Related Information

- [Receive Faxes Using PC-FAX Receive \(Windows\)](#)
-

PC-FAX for Mac(Sending only)

Related Models: MFC-L5718DN/MFC-L5728DW

- [Send a Fax Using AirPrint \(macOS\)](#)

Network

- [Supported Basic Network Features](#)
- [Configure Network Settings](#)
- [Wireless Network Settings](#)
- [Network Features](#)

Supported Basic Network Features

The machine supports various features depending on the operating system. Use this table to see which network features and connections are supported by each operating system.

Operating Systems	Windows	Windows Server	macOS
Printing	Yes	Yes	Yes
Scanning	Yes		Yes
PC Fax Send	Yes		Yes
PC Fax Receive	Yes		
Web Based Management ¹	Yes	Yes	Yes
Status Monitor	Yes		
Driver Deployment Wizard	Yes	Yes	

¹ The default password to manage your machine's settings is located on the back of the machine and marked "Pwd". We recommend immediately changing the default password to protect your machine from unauthorised access.



- When connecting your machine to an outside network such as the Internet, make sure your network environment is protected by a separate firewall or other means in order to prevent information leaks due to inadequate settings or unauthorised access by malicious third parties.
- When your machine is connected to the global network, a warning appears. When you see this warning, we strongly recommend confirming your network settings, and then re-connecting to a secure network.
- Enabling your machine's global network communication filtering feature blocks access from the global network. The global network communication filtering feature may prevent the machine from receiving certain print or scan jobs from a computer or mobile device that uses a global IP address.



Related Information

- [Network](#)

Related Topics:

- [Set or Change a Login Password for Web Based Management](#)

Configure Network Settings

- [Configure Network Details Using the Control Panel](#)
- [Change Machine Settings Using Web Based Management](#)

Configure Network Details Using the Control Panel

To configure the machine for your network, use the control panel's [Network] menu selections.



- For information about the network settings you can configure using the control panel, see *Related Information: Settings Tables*.
- You can also use Web Based Management, to configure and change your machine's network settings.

1. Press  [Settings] > [All Settings] > [Network].



If your machine displays the [All Settings] menu on the Home screen, skip the [Settings] menu.

2. Swipe up or down or press ▲ or ▼ to display the network option you want, and then press it. Repeat this step until you access the menu you want to configure, and then follow the LCD instructions.



Related Information

- [Configure Network Settings](#)

Related Topics:

- [Settings Tables \(MFC-L5718DN/MFC-L5728DW\)](#)
- [Settings Tables \(DCP-L5518DN\)](#)
- [Supported Basic Network Features](#)

Wireless Network Settings

Related Models: MFC-L5728DW

- [Use the Wireless Network](#)
- [Use Wi-Fi Direct[®]](#)
- [Enable/Disable Wireless LAN](#)
- [Print the WLAN Report](#)

Use the Wireless Network

Related Models: MFC-L5728DW

- [Before Configuring Your Machine for a Wireless Network](#)
- [Configure Your Machine for a Wireless Network Using the Setup Wizard from Your Computer](#)
- [Configure Your Machine for a Wireless Network Using the Machine's Control Panel Setup Wizard](#)
- [Configure Your Machine for a Wireless Network Using the One Push Method of Wi-Fi Protected Setup™ \(WPS\)](#)
- [Configure Your Machine for a Wireless Network Using the PIN Method of Wi-Fi Protected Setup™ \(WPS\)](#)
- [Configure Your Machine for a Wireless Network When the SSID Is Not Broadcast](#)
- [Configure Your Machine for an Enterprise Wireless Network](#)

Before Configuring Your Machine for a Wireless Network

Related Models: MFC-L5728DW

Before attempting to configure a wireless network, confirm the following:

- If you are using an enterprise wireless network, you must know the User ID and Password.
- To achieve optimum results with normal everyday document printing, place your machine as close to the wireless LAN access point/router as possible with minimal obstructions. Large objects and walls between the two devices and interference from other electronic devices can affect the data transfer speed of your documents.

Due to these factors, wireless may not be the best method of connection for all types of documents and applications. If you are printing large files, such as multi-page documents with mixed text and large graphics, you may want to consider selecting wired Ethernet for faster data transfer (supported models only), or USB for the fastest throughput speed.

- Although your machine can be used in a wired and wireless network (supported models only), only one connection method can be used at a time. However, a wireless network connection and Wi-Fi Direct connection, or a wired network connection (supported models only) and Wi-Fi Direct connection can be used at the same time.
- If there is a signal in the vicinity, wireless LAN allows you to freely make a LAN connection. However, if security settings are not correctly configured, the signal may be intercepted by malicious third-parties, possibly resulting in:
 - Theft of personal or confidential information
 - Improper transmission of information to parties impersonating the specified individuals
 - Dissemination of transcribed communication contents that were intercepted



Make sure you know your wireless router/access point's Network Name (SSID) and Network Key (Password). If you cannot find this information, consult the manufacturer of your wireless router/access point, your system administrator, or Internet provider. Brother cannot provide this information.



Related Information

- [Use the Wireless Network](#)

Configure Your Machine for a Wireless Network Using the Setup Wizard from Your Computer

Related Models: MFC-L5728DW

1. Download the installer from your model's **Downloads** page at support.brother.com/downloads.
2. Start the installer, and then follow the on-screen instructions.
3. Select **Wireless Network Connection (Wi-Fi)**, and then click **Next**.
4. Follow the on-screen instructions.

You have completed the wireless network setup.



Related Information

- [Use the Wireless Network](#)

Configure Your Machine for a Wireless Network Using the Machine's Control Panel Setup Wizard

Related Models: MFC-L5728DW

Before configuring your machine, we recommend writing down your wireless network settings. You will need this information before you continue with the configuration.

1. Check and record the current wireless network settings of the computer to which you are connecting.

Network Name (SSID)

Network Key (Password)

For example:

Network Name (SSID)
HELLO

Network Key (Password)
12345



- Your access point/router may support the use of multiple WEP keys, but your Brother machine supports the use of only the first WEP key.
- If you need assistance during setup and want to contact Brother customer service, make sure you have your SSID (Network Name) and Network Key (Password) ready. We cannot assist you in locating this information.
- If you do not know this information (SSID and Network Key), you cannot continue with the wireless setup.

How can I find this information?

- a. Check the documentation provided with your wireless access point/router.
- b. The initial SSID could be the manufacturer's name or the model name.
- c. If you do not know the security information, consult the router manufacturer, your system administrator, or your Internet provider.

2. Press  [Settings] > [All Settings] > [Network] > [WLAN (Wi-Fi)] > [Find Wi-Fi Network].

3. When [Enable WLAN?] appears, press [Yes].

This will start the wireless setup wizard. To cancel, press [No].

4. The machine will search for your network and display a list of available SSIDs.

If a list of SSIDs is displayed, swipe up or down or press ▲ or ▼ to display the SSID to which you want to connect, and then press the SSID.

5. Press [OK].

6. Do one of the following:

- If you are using an authentication and encryption method that requires a Network Key, enter the Network Key you wrote down in the first step.

When you have entered all the characters, press [OK].

-
- If your authentication method is Open System and your encryption mode is None, go to the next step.
7. The machine attempts to connect to the wireless device you have selected.

If your wireless device is connected successfully, the machine's LCD displays [Connected]. Press [OK], and then press .

You have completed the wireless network setup. To install the drivers or the application necessary for operating your machine, go to your model's **Downloads** page at support.brother.com/downloads.



Related Information

- [Use the Wireless Network](#)

Related Topics:

- [How to Enter Text on Your Machine](#)
 - [Wireless LAN Report Error Codes](#)
-

Configure Your Machine for a Wireless Network Using the One Push Method of Wi-Fi Protected Setup™ (WPS)

Related Models: MFC-L5728DW

If your wireless access point/router supports WPS (PBC: Push Button Configuration), you can use WPS from your machine's control panel menu to configure your wireless network settings.

1. Press  [Settings] > [All Settings] > [Network] > [WLAN (Wi-Fi)] > [WPS/Push Button].
2. When [Enable WLAN?] appears, press [Yes].
This will start the wireless setup wizard. To cancel, press [No].
3. When the touchscreen displays [Start WPS on your wireless access point/router, then press [OK].], press the WPS button on your wireless access point/router. Then press [OK] on your machine. Your machine will automatically detect your wireless access point/router and try to connect to your wireless network.

If your wireless device is connected successfully, the machine's LCD displays [Connected]. Press [OK], and then press .

You have completed the wireless network setup. To install the drivers and software necessary to use your machine, go to your model's **Downloads** page at support.brother.com/downloads.

Related Information

- [Use the Wireless Network](#)

Related Topics:

- [Wireless LAN Report Error Codes](#)

Configure Your Machine for a Wireless Network Using the PIN Method of Wi-Fi Protected Setup™ (WPS)

Related Models: MFC-L5728DW

If your wireless LAN access point/router supports WPS, you can use the Personal Identification Number (PIN) Method to configure your wireless network settings.

The PIN Method is one of the connection methods developed by the Wi-Fi Alliance®. By submitting a PIN created by an Enrollee (your machine) to the Registrar (a device that manages the wireless LAN), you can set up the wireless network and security settings. For more information on how to access WPS mode, see the instructions provided with your wireless access point/router.

Type A

Connection when the wireless LAN access point/router (1) doubles as the Registrar:

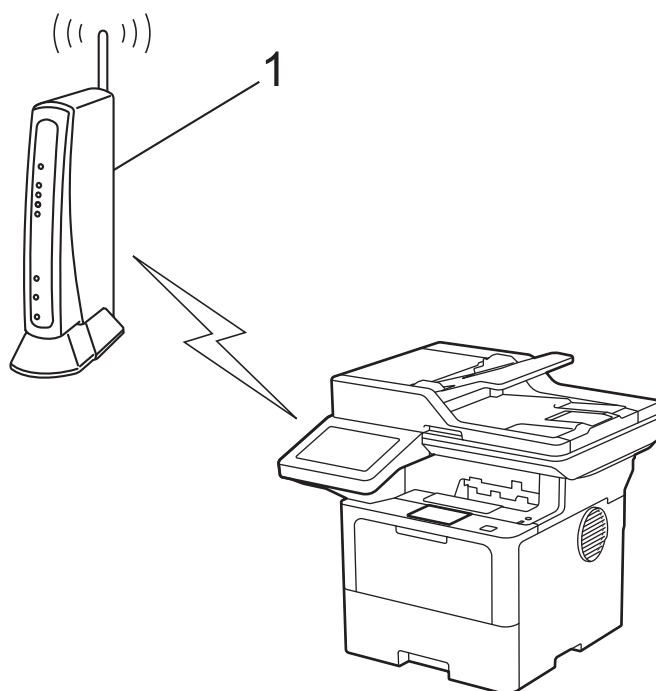

Type B

Connection when another device (2), such as a computer, is used as the Registrar:

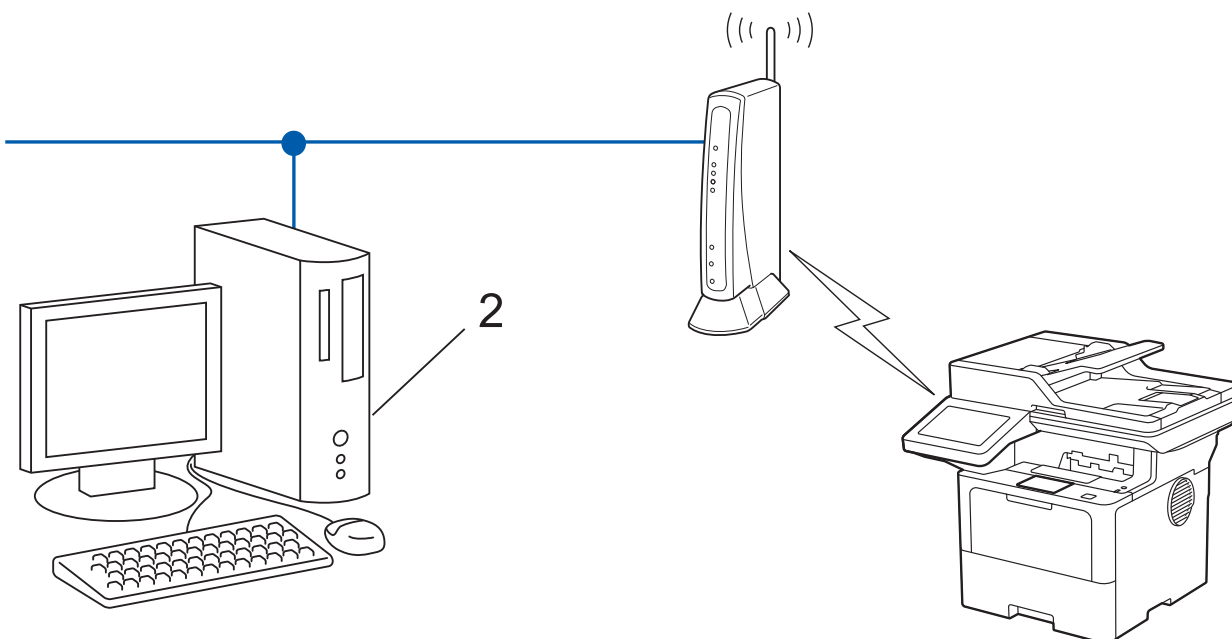



1. Press  [Settings] > [All Settings] > [Network] > [WLAN (Wi-Fi)] > [WPS/PIN Code].
2. When [Enable WLAN?] appears, press [Yes].
This will start the wireless setup wizard. To cancel, press [No].
3. The LCD displays an eight-digit PIN and the machine starts searching for a wireless LAN access point/router.
4. Using a computer connected to the network, in your browser's address bar, type the IP address of the device you are using as the Registrar (for example: <http://192.168.1.2>).
5. Go to the WPS settings page and type the PIN, and then follow the on-screen instructions.



- The Registrar is usually the wireless LAN access point/router.
- The settings page may differ depending on the brand of wireless LAN access point/router. For more information, see the instructions supplied with your wireless LAN access point/router.

If you are using a Windows 10 or Windows 11 computer as a Registrar, complete the following steps:

6. Do one of the following:
 - Windows 11
Click  > **All apps** > **Windows Tools** > **Control Panel**. In the **Hardware and Sound** group, click **Add a device**.
 - Windows 10
Click  > **Windows System** > **Control Panel**. In the **Hardware and Sound** group, click **Add a device**.



- To use a Windows 10 or Windows 11 computer as a Registrar, you must register it to your network in advance. For more information, see the instructions supplied with your wireless LAN access point/router.
- If you use Windows 10 or Windows 11 as a Registrar, you can install the printer driver after the wireless configuration by following the on-screen instructions. To install the driver and software necessary to use your machine, go to your model's **Downloads** page at support.brother.com/downloads.

7. Select your machine and click **Next**.
8. Type the PIN displayed on the machine's LCD, and then click **Next**.
9. Click **Close**.

If your wireless device is connected successfully, the machine's LCD displays [Connected]. Press [OK], and then press .

You have completed the wireless network setup. To install the drivers or the application necessary for operating your machine, go to your model's **Downloads** page at support.brother.com/downloads.



Related Information

- [Use the Wireless Network](#)

Related Topics:

- [Wireless LAN Report Error Codes](#)
-

Configure Your Machine for a Wireless Network When the SSID Is Not Broadcast

Related Models: MFC-L5728DW

Before configuring your machine, we recommend writing down your wireless network settings. You will need this information before you continue with the configuration.

1. Check and write down the current wireless network settings.

Network Name (SSID)		
Authentication Method	Encryption Mode	Network Key
Open System	NONE	-
	WEP	
Shared Key	WEP	
WPA/WPA2-PSK	AES	
	TKIP	
WPA3-SAE	AES	

For example:

Network Name (SSID)		
HELLO		
Authentication Method	Encryption Mode	Network Key
WPA2-PSK	AES	12345678



If your router uses WEP encryption, enter the key used as the first WEP key. Your Brother machine supports the use of the first WEP key only.

2. Press  [Settings] > [All Settings] > [Network] > [WLAN (Wi-Fi)] > [Find Wi-Fi Network].
3. When [Enable WLAN?] appears, press [Yes].
This will start the wireless setup wizard. To cancel, press [No].
4. The machine will search for your network and display a list of available SSIDs. Swipe up or down or press ▲ or ▼ to display [<New SSID>]. Press [<New SSID>], and then press [OK].
5. Enter the SSID name, and then press [OK].
6. Select the Authentication Method.
7. Do one of the following:
 - If you selected the [Open System] option, press the Encryption type [None] or [WEP].
If you selected the [WEP] option for Encryption type, select and enter the WEP key, and then press [OK].
 - If you selected the [Shared Key] option, select and enter the WEP key, and then press [OK].
 - If you selected the [WPA/WPA2-PSK] option, press the Encryption type [TKIP+AES] or [AES].
Enter the WPA™ key, and then press [OK].
 - If you selected the [WPA3-SAE] option, press the Encryption type [AES].

Enter the WPA™ key, and then press [OK].



Your Brother machine supports the use of the first WEP key only.

8. The machine attempts to connect to the wireless device you have selected.

If your wireless device is connected successfully, the machine's LCD displays [Connected]. Press [OK], and then press .

You have completed the wireless network setup. To install the drivers or the application necessary for operating your machine, go to your model's **Downloads** page at support.brother.com/downloads.



Related Information

- [Use the Wireless Network](#)

Related Topics:

- [I Cannot Complete the Wireless Network Setup Configuration](#)
 - [How to Enter Text on Your Machine](#)
 - [Wireless LAN Report Error Codes](#)
-

Configure Your Machine for an Enterprise Wireless Network

Related Models: MFC-L5728DW

Before configuring your machine, we recommend writing down your wireless network settings. You will need this information before you continue with the configuration.

1. Check and record the current wireless network settings.

Network Name (SSID)			
Authentication Method	Encryption Mode	User ID	Password
EAP-FAST/NONE	AES		
	TKIP		
EAP-FAST/MS-CHAPv2	AES		
	TKIP		
EAP-FAST/GTC	AES		
	TKIP		
PEAP/MS-CHAPv2	AES		
	TKIP		
PEAP/GTC	AES		
	TKIP		
EAP-TTLS/CHAP	AES		
	TKIP		
EAP-TTLS/MS-CHAP	AES		
	TKIP		
EAP-TTLS/MS-CHAPv2	AES		
	TKIP		
EAP-TTLS/PAP	AES		
	TKIP		
EAP-TLS	AES		-
	TKIP		-

For example:

Network Name (SSID)			
HELLO			
Authentication Method	Encryption Mode	User ID	Password
EAP-FAST/MS-CHAPv2	AES	Brother	12345678



- If you configure your machine using EAP-TLS authentication, you must install the client certificate issued by a CA before you start configuration. Contact your network administrator about the client certificate. If you have installed more than one certificate, we recommend writing down the certificate name you want to use.
- If you verify your machine using the common name of the server certificate, we recommend writing down the common name before you start configuration. Contact your network administrator about the common name of the server certificate.

2. Press  [Settings] > [All Settings] > [Network] > [WLAN (Wi-Fi)] > [Find Wi-Fi Network].
3. When [Enable WLAN?] appears, press [Yes].
This will start the wireless setup wizard. To cancel, press [No].
4. The machine will search for your network and display a list of available SSIDs. Swipe up or down or press ▲ or ▼ to display [<New SSID>]. Press [<New SSID>], and then press [OK].
5. Enter the SSID name, and then press [OK].
6. Select the Authentication Method.
7. Do one of the following:
 - If you selected the [EAP-FAST], [PEAP] or [EAP-TTLS] option, select the Inner Authentication method [NONE], [CHAP], [MS-CHAP], [MS-CHAPv2], [GTC] or [PAP].



Depending on your Authentication method, the Inner Authentication method selections may differ.

Select the encryption type [TKIP+AES] or [AES].

Select the verification method [No Verification], [CA] or [CA + Server ID].

- If you selected the [CA + Server ID] option, enter the server ID, user ID, and password (if required), and then press [OK] for each option.
- For other selections, enter the user ID and Password, and then press [OK] for each option.



If you have not imported a CA certificate into your machine, the machine displays [No Verification].

- If you selected the [EAP-TLS] option, select the encryption type [TKIP+AES] or [AES].
The machine will display a list of available Client Certificates, and then select the certificate.
Select the verification method [No Verification], [CA] or [CA + Server ID].
 - If you selected the [CA + Server ID] option, enter the server ID and user ID, and then press [OK] for each option.
 - For other selections, enter the user ID, and then press [OK].

8. The machine attempts to connect to the wireless device you have selected.

If your wireless device is connected successfully, the machine's LCD displays [Connected]. Press [OK], and then press .

You have completed the wireless network setup. To install the drivers or the application necessary for operating your machine, go to your model's **Downloads** page at support.brother.com/downloads.



Related Information

- [Use the Wireless Network](#)

Related Topics:

- [Wireless LAN Report Error Codes](#)

Use Wi-Fi Direct®

Related Models: MFC-L5728DW

- [Wi-Fi Direct Overview](#)
- [Configure Your Wi-Fi Direct Network Manually](#)
- [Configure Wi-Fi Direct Network Using the Push Button Method](#)

Wi-Fi Direct Overview

Related Models: MFC-L5728DW

Wi-Fi Direct is one of the wireless configuration methods developed by the Wi-Fi Alliance®. It allows you to securely connect your mobile device to your machine without using a wireless router/access point.

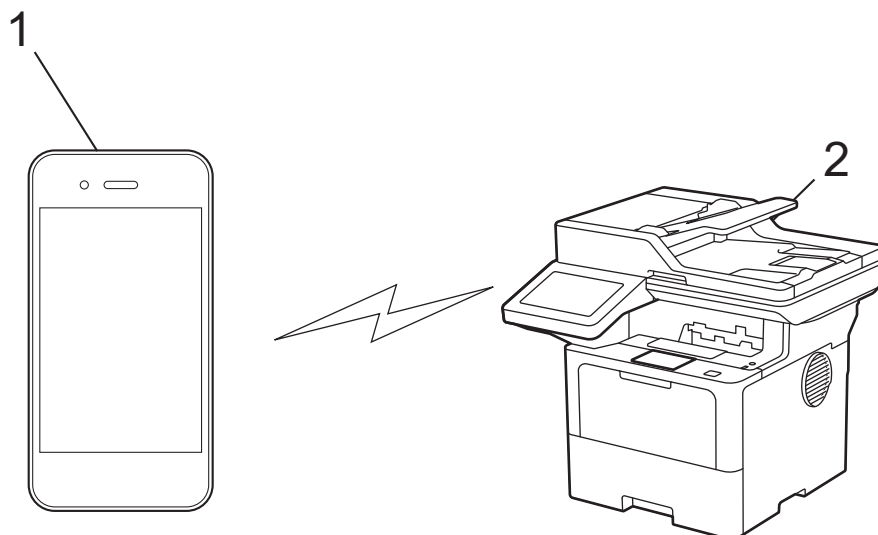

1. Mobile device
2. Your machine



- You can use Wi-Fi Direct with the wired or wireless network connection at the same time.
- The Wi-Fi Direct-supported device can become a Group Owner. When configuring the Wi-Fi Direct network, the Group Owner serves as an access point.



Related Information

- [Use Wi-Fi Direct®](#)

Related Topics:

- [Configure Your Wi-Fi Direct Network Manually](#)
- [Configure Wi-Fi Direct Network Using the Push Button Method](#)

Configure Your Wi-Fi Direct Network Manually

Related Models: MFC-L5728DW

Configure the Wi-Fi Direct settings from the machine's control panel:



When the machine receives a Wi-Fi Direct request from your mobile device, the message [Wi-Fi Direct connection request received. Press [OK] to connect.] appears on the LCD. Press [OK] to connect.

1. Press  [Settings] > [All Settings] > [Network] > [Wi-Fi Direct] > [Manual].
2. The machine will display the SSID (Network Name) and Password (Network Key). Go to your mobile device's wireless network settings screen, select the SSID, and then enter the password.
3. When your mobile device connects successfully, the machine's LCD displays [Connected].



Related Information

- [Use Wi-Fi Direct®](#)

Related Topics:

- [Wi-Fi Direct Overview](#)
- [Configure Wi-Fi Direct Network Using the Push Button Method](#)

Configure Wi-Fi Direct Network Using the Push Button Method

Related Models: MFC-L5728DW



When the machine receives a Wi-Fi Direct request from your mobile device, the message [Wi-Fi Direct connection request received. Press [OK] to connect.] appears on the LCD. Press [OK] to connect.

1. Press  [Settings] > [All Settings] > [Network] > [Wi-Fi Direct] > [Push Button] on your machine's LCD.



If your mobile device does not support Wi-Fi Direct, do the following:

- a. Press  [Settings] > [All Settings] > [Network] > [Wi-Fi Direct] > [Group Owner], and then press [On].
 - b. Swipe up or down or press ▲ or ▼ to select the [Push Button].
2. When the [Activate Wi-Fi Direct on other device. Then Press [OK].] message appears, turn your mobile device's Wi-Fi Direct function on (for more information, see your mobile device's user's guide). Press [OK] on your machine.
 3. Do one of the following:
 - If your mobile device displays a list of machines with Wi-Fi Direct enabled, select your Brother machine.
 - If your Brother machine displays a list of mobile devices with Wi-Fi Direct enabled, select your mobile device. To search for available devices again press [Rescan].
 4. When your mobile device connects successfully, the machine's LCD displays [Connected].



Related Information



- [Use Wi-Fi Direct®](#)

Related Topics:

- [Wi-Fi Direct Overview](#)
- [Configure Your Wi-Fi Direct Network Manually](#)

Enable/Disable Wireless LAN

Related Models: MFC-L5728DW

1. Press  [Settings] > [All Settings] > [Network] > [WLAN (Wi-Fi)].
2. Swipe up or down or press ▲ or ▼ to select the [WLAN Enable] option. Press [WLAN Enable].
3. Do one of the following:
 - To enable Wi-Fi, select [On].
 - To disable Wi-Fi, select [Off].
4. Press .





Related Information

- [Wireless Network Settings](#)

Print the WLAN Report

Related Models: MFC-L5728DW

The WLAN Report shows your machine's wireless status. If the wireless connection fails, check the error code on the printed report.

1. Press  [Settings] > [All Settings] > [Print Reports] > [WLAN Report].
2. Press [Yes].
The machine will print the WLAN Report.
3. Press .

If the WLAN Report does not print, check your machine for errors. If there are no visible errors, wait for one minute and then try to print the report again.

Related Information

- [Wireless Network Settings](#)
 - [Wireless LAN Report Error Codes](#)

Related Topics:

- [My Machine Cannot Print, Scan, or Use the PC-FAX Receive Function over the Network](#)
- [I Want to Check that My Network Devices are Working Correctly](#)

Wireless LAN Report Error Codes

Related Models: MFC-L5728DW

If the Wireless LAN Report shows that the connection failed, check the error code on the printed report and see the corresponding instructions in the table:

Error Code	Problem and Recommended Solutions
TS-01	<p>The WLAN (Wi-Fi) is not enabled.</p> <p>Check the following points and try to set up your wireless connection again:</p> <ul style="list-style-type: none">• Enable the WLAN setting on your machine.• If a network cable is connected to your machine, disconnect it.
TS-02	<p>The wireless router/access point cannot be detected.</p> <p>Check the following points and try to set up your wireless connection again:</p> <ul style="list-style-type: none">• Make sure the wireless router/access point is on.• Temporarily place your machine closer to the wireless router/access point when you are configuring the wireless settings.• If your wireless router/access point is using MAC address filtering, confirm that the MAC address of the machine is allowed in the filter. You can find the MAC address by printing the Network Configuration Report.• If you manually entered the Network Name (SSID) and security information (authentication method/encryption method), the information may be incorrect. Check the Network Name and security information again and re-enter the correct information.• Restart your wireless router/access point. If you cannot find the Network Name (SSID) and security information, see the documentation provided with your wireless router/access point, or contact the router manufacturer, your system administrator, or Internet service provider.
TS-03	<p>The wireless enterprise network and security settings you entered may be incorrect.</p> <p>Check the following points and try to set up your wireless connection again:</p> <p>Verify the following information:</p> <ul style="list-style-type: none">- Network Name (SSID) you selected to configure your machine.- Security information you selected to configure your machine (such as the authentication method, encryption method, or User ID). <p>If you still cannot find the Network Name (SSID) and security information, see the documentation provided with your wireless router/access point, or contact the router manufacturer, your system administrator, or Internet service provider.</p>

Error Code	Problem and Recommended Solutions
TS-04	<p>Your machine does not support the authentication and encryption methods used by the selected wireless router/access point.</p> <p>For infrastructure mode (Most common)</p> <p>Change the authentication and encryption methods of the wireless router/access point. Your machine supports the following authentication and encryption methods:</p> <ul style="list-style-type: none"> • WPA-Personal: TKIP / AES • WPA2-Personal: TKIP / AES • WPA3-Personal: AES • OPEN: WEP / NONE (without encryption) • Shared key: WEP <p>If your issue is not resolved, the Network Name (SSID) or security settings you entered may be incorrect. Check that all wireless network settings are correct for your network.</p>
TS-05	<p>The Network Name (SSID) and Network Key (Password) are incorrect.</p> <p>Check the following points and try to set up your wireless connection again:</p> <ul style="list-style-type: none"> • Confirm the Network Name (SSID) and Network Key (Password). • If your Network Key contains upper-case and lower-case letters, make sure you type them correctly. • If you cannot find the Network Name (SSID) and security information, see the documentation provided with your wireless router/access point, or contact the router manufacturer, your system administrator, or Internet service provider. • If your wireless router/access point uses WEP encryption with multiple WEP keys, write down and use only the first WEP key.
TS-06	<p>The wireless security information (authentication method/encryption method/Network Key (Password)) is incorrect.</p> <p>Check the following points and try to set up your wireless connection again:</p> <ul style="list-style-type: none"> • Confirm the Network Key. If your Network Key contains upper-case and lower-case letters, make sure you type them correctly. • Confirm whether the authentication method entered and the authentication method or encryption method supported by the wireless router/access point are the same. • If the Network key, authentication method, and encryption method have been confirmed, restart your wireless router/access point and the machine. • If your wireless router/access point's Stealth Mode is on, you may need to disable it to connect to the wireless network. <p>If you cannot find the Network Name (SSID) and security information, see the documentation provided with your wireless router/access point, or contact the router manufacturer, your system administrator, or Internet service provider.</p>
TS-07	<p>The machine cannot detect a wireless router/access point that has WPS (Wi-Fi Protected Setup) enabled.</p> <p>Check the following points and try again:</p> <ul style="list-style-type: none"> • To check if your wireless router/access point supports WPS, look for the WPS symbol displayed on the router/access point. For more information, see the documentation provided with your wireless router/access point. • To set up your wireless connection using WPS, you must configure both your machine and the wireless router/access point. For more information, see the user's guide. • If you do not know how to set up your wireless router/access point using WPS, see the documentation provided with your wireless router/access point, or contact the router manufacturer, your system administrator, or Internet service provider.

Error Code	Problem and Recommended Solutions
TS-08	<p>Two or more wireless routers or access points that have WPS enabled are detected.</p> <p>Check the following points and try again:</p> <ul style="list-style-type: none"> • Make sure that only one wireless router/access point within range has WPS enabled, and then try to connect again. • Try to connect again after a few minutes to avoid interference from other access points/routers.



How to confirm wireless security information (SSID/authentication method/encryption method/Network Key) of your WLAN access point/router:

1. The default security settings may be provided on a label attached to the WLAN access point/router. Or the manufacturer's name or model number of the WLAN access point/router may be used as the default security settings.
2. See the documentation provided with your WLAN access point/router for information on how to find the security settings.
 - If the WLAN access point/router is set to not broadcast the SSID, the SSID will not automatically be detected. You will have to manually enter the SSID name.
 - The Network Key may also be described as the Password, Security Key, or Encryption Key.

If you do not know the SSID and wireless security settings of your WLAN access point/router or how to change the configuration, see the documentation provided with your WLAN access point/router, ask the manufacturer of your access point/router or ask your Internet provider or network administrator.



Related Information

- [Print the WLAN Report](#)

Related Topics:

- [My Machine Cannot Print, Scan, or Use the PC-FAX Receive Function over the Network](#)
- [I Want to Check that My Network Devices are Working Correctly](#)
- [Configure Your Machine for a Wireless Network Using the One Push Method of Wi-Fi Protected Setup™ \(WPS\)](#)
- [Configure Your Machine for a Wireless Network Using the PIN Method of Wi-Fi Protected Setup™ \(WPS\)](#)
- [Configure Your Machine for a Wireless Network Using the Machine's Control Panel Setup Wizard](#)
- [Configure Your Machine for a Wireless Network When the SSID Is Not Broadcast](#)
- [Configure Your Machine for an Enterprise Wireless Network](#)

Network Features

- [Enable/Disable Web Based Management Using the Control Panel](#)
- [Configure the Proxy Server Settings Using Web Based Management](#)
- [Print the Network Configuration Report](#)
- [Configure PC-FAX Receive Using Web Based Management](#)
- [Fax Using the Internet \(I-Fax\)](#)
- [Use the Send Fax to Server Feature](#)
- [Configure and Operate LDAP Search](#)
- [Synchronise Time with the SNTP Server Using Web Based Management](#)
- [Gigabit Ethernet \(Wired Network Only\)](#)
- [Reset the Network Settings to the Factory Settings](#)

Enable/Disable Web Based Management Using the Control Panel

1. Press  [Settings] > [All Settings] > [Network] > [Web Based Mgmt].
2. Press to select the option you want.



If you enable this function, make sure you specify the connection method to use Web Based Management.



Related Information

- [Network Features](#)
-

Configure the Proxy Server Settings Using Web Based Management

If your network uses a proxy server, the following proxy server information must be configured using Web Based Management:

- Proxy server address
- Port number
- User Name
- Password



- We recommend using the latest version of the following web browsers:
 - Microsoft Edge, Firefox, and Google Chrome™ for Windows
 - Safari, Firefox, and Google Chrome™ for Mac
 - Google Chrome™ for Android™
 - Safari and Google Chrome™ for iOS
- Ensure that JavaScript and Cookies are always enabled, regardless of which browser you use.

1. Start your web browser.
2. Type "https://machine's IP address" in your browser's address bar (where "machine's IP address" is your machine's IP address).

For example:

https://192.168.1.2

3. If required, type the password in the **Login** field, and then click **Login**.



The default password to manage this machine's settings is located on the back of the machine and marked "Pwd".

4. Go to the navigation menu, and then click **Network > Network > Protocol**.



Start from ☰, if the navigation menu is not shown on the left side of the screen.

5. Make sure the **Proxy** checkbox is selected, and then click **Submit**.
6. In the **Proxy** field, click **Advanced Setting**.
7. Enter the proxy server information.
8. Click **Submit**.



Related Information

- [Network Features](#)

Related Topics:



- [WeChat Print](#)

Print the Network Configuration Report

The Network Configuration Report lists the network configuration, including the network print server settings.



- The Node Name appears on the Network Configuration Report. The default Node Name is "BRN123456abcdef" for a wired network or "BRW123456abcdef" for a wireless network (where "123456abcdef" is your machine's MAC Address / Ethernet Address.)
- If the IP Address on the Network Configuration Report shows 0.0.0.0, wait for one minute and try printing it again.
- You can find your machine's settings, such as the IP address, subnet mask, node name, and MAC Address on the report, for example:
 - IP address: 192.168.0.5
 - Subnet mask: 255.255.255.0
 - Node name: BRN000ca0000499
 - MAC Address: 00-0c-a0-00-04-99

1. Press  [Settings] > [All Settings] > [Print Reports] > [Network Configuration].
2. Press [Yes].
3. Press .



Related Information

- [Network Features](#)

Related Topics:

- [Check Your Machine's Network Settings](#)
- [Use the Network Connection Repair Tool \(Windows\)](#)
- [Error Messages](#)
- [I Want to Check that My Network Devices are Working Correctly](#)
- [Access Web Based Management](#)
- [Configure the Gigabit Ethernet Settings Using Web Based Management](#)

Configure PC-FAX Receive Using Web Based Management

Related Models: MFC-L5718DN/MFC-L5728DW

Use Web Based Management to configure your PC Fax Receiving in a web browser.

1. Start your web browser.
2. Type "https://machine's IP address" in your browser's address bar (where "machine's IP address" is your machine's IP address).

For example:

https://192.168.1.2

3. If required, type the password in the **Login** field, and then click **Login**.



The default password to manage this machine's settings is located on the back of the machine and marked "Pwd".

4. Go to the navigation menu, and then click **Network > Network > Protocol**.



Start from ☰, if the navigation menu is not shown on the left side of the screen.

5. Select the **PC Fax Receive** checkbox, and then click **Submit**.
6. Restart your Brother machine to activate the configuration.



Related Information

- [Network Features](#)

Related Topics:

- [Run Brother PC-FAX Receive on Your Computer \(Windows\)](#)

Fax Using the Internet (I-Fax)

Related Models: MFC-L5718DN/MFC-L5728DW

With Internet Fax (I-Fax), you can send and receive fax documents using the Internet. Documents are transmitted in email messages as attached TIFF-F files. Your computer can send and receive documents as long as it has an application that can create and view TIFF-F files. You can use any TIFF-F viewer application. Documents sent via the machine will be converted into a TIFF-F format automatically. To send and receive messages to and from your machine, your computer's email application must support Multipurpose Internet Mail Extensions (MIME).

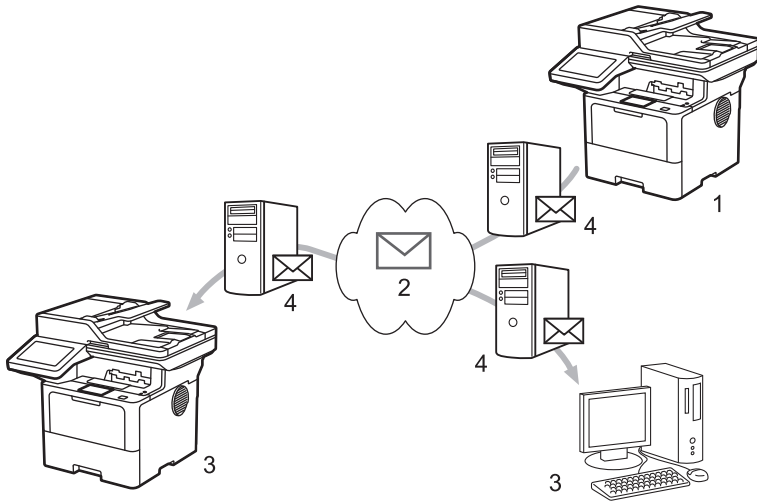

1. Sender
2. Internet
3. Receiver
4. Email server



I-Fax supports sending and receiving documents in Letter or A4 format and in monochrome only.



Related Information

- [Network Features](#)
 - [Important Information about Internet Fax \(I-Fax\)](#)
 - [Configure the Brother Machine for Email or Internet Fax \(I-Fax\)](#)
 - [Send an Internet Fax \(I-Fax\)](#)
 - [Poll the Server Manually](#)
 - [I-Fax Options](#)

Important Information about Internet Fax (I-Fax)

Related Models: MFC-L5718DN/MFC-L5728DW

I-Fax communication on a LAN is very similar to communication via email; however, it is different from fax communication using standard phone lines. Make sure you read the following information about using I-Fax:

- Factors such as the receiver's location, structure of the LAN and how busy the circuit (such as the Internet) is may cause the system to take longer than usual to send an error mail.
- When sending confidential documents, we recommend using standard phone lines instead of the Internet (due to its low level of security).
- If the receiver's mail system is not MIME-compatible, you cannot use I-Fax to send documents. If possible, check this in advance, and note that some servers will not send an error reply.
- If a document is too large to send via I-Fax, it may not reach the receiver.
- You cannot change the font or size of the text in any Internet mail you receive.



Related Information

- [Fax Using the Internet \(I-Fax\)](#)

Configure the Brother Machine for Email or Internet Fax (I-Fax)

Before using I-Fax, configure your Brother machine to communicate with your network and mail server. You can configure these items using the machine's control panel or Web Based Management. Make sure the following items are configured on your machine:

- IP address (If you are already using your machine on your network, the machine's IP address has been configured correctly.)
- Email address
- SMTP, POP3, IMAP4 server address/port/Authentication method/Encryption method/Server Certificate Verification
- Mailbox name and password

If you are unsure of any of these items, contact your system administrator.



Related Information

- [Fax Using the Internet \(I-Fax\)](#)
 - [Initial Setup for Email or Internet Fax \(I-Fax\)](#)
 - [How Received I-Faxes Appear on a Computer](#)

Initial Setup for Email or Internet Fax (I-Fax)

Before sending your I-Fax, use the control panel or Web Based Management to configure the following optional items:

- E-mail Subject
- E-mail Message
- Size Limit
- Request Delivery Notification (Send)

E-mail Send

E-mail Subject

Internet Fax Job

E-mail Message

Image data has been attached.

Size Limit

- Off
 On

Maximum Size

1 MB

Request Delivery Notification (Send)

- Off
 On

[POP3/IMAP4/SMTP Client>>](#)

Cancel

Submit

If you are unsure of any of these items, contact your system administrator.

✓ Related Information

- [Configure the Brother Machine for Email or Internet Fax \(I-Fax\)](#)
 - [How Your Brother Machine Receives an Internet Fax \(I-Fax\)](#)

How Your Brother Machine Receives an Internet Fax (I-Fax)

Related Models: MFC-L5718DN/MFC-L5728DW

When your Brother machine receives an incoming I-Fax, it will print the I-Fax automatically. To receive an I-Fax, we recommend using the control panel or Web Based Management to configure the following optional items:

- **Auto Polling**
- **Polling Frequency**
- **Print Mail Header**
- **Delete/Read Receive Error Mail**
- **Send Delivery Notification (Receive)**

E-mail Receive

Auto Polling

- Off
 On

Polling Frequency

10 Mins

Print Mail Header

None

Delete/Read Receive Error Mail

- Off
 On

Send Delivery Notification (Receive)

Off

[POP3/IMAP4/SMTP Client>>](#)

Cancel

Submit

There are two ways you can receive email messages:

- POP3/IMAP4 receiving at regular intervals

-
- POP3/IMAP4 receiving, manually initiated

When using POP3/IMAP4 receiving, the machine polls your email server to receive data. Polling can occur at set intervals (for example, you can configure the machine to poll the email server every ten minutes) or you can manually poll the server.



- If your machine starts to receive email data, the LCD displays [Receiving]. The email will be printed automatically.
 - If your machine is out of paper when receiving data, the received data will be held in the machine's memory. This data will be printed automatically after paper is reloaded in the paper tray.
 - When the machine's Temporary Fax Backup Function is turned on, received data will be stored for a certain period of time.
 - If the received mail is not in a plain text format, or an attached file is not in the TIFF-F format, the error message "**ATTACHED FILE FORMAT NOT SUPPORTED**" will be printed.
 - If the received mail is too large, the error message "**E-MAIL FILE TOO LARGE**" will be printed.
 - If **Delete/Read Receive Error Mail** is **On** (default), then the error mail will be deleted from the email server automatically.
-



Related Information

- [Initial Setup for Email or Internet Fax \(I-Fax\)](#)

Related Topics:

- [How Received I-Faxes Appear on a Computer](#)
-

How Received I-Faxes Appear on a Computer

Related Models: MFC-L5718DN/MFC-L5728DW

When a computer receives an I-Fax document, the document is attached to an email message that notifies you in its Subject field that your email server has received an I-Fax. You can either wait for your Brother machine to poll the email server, or you can manually poll the email server to receive the incoming data.



Related Information

- [Configure the Brother Machine for Email or Internet Fax \(I-Fax\)](#)

Related Topics:

- [How Your Brother Machine Receives an Internet Fax \(I-Fax\)](#)



Send an Internet Fax (I-Fax)



Related Models: MFC-L5718DN/MFC-L5728DW

Sending an I-Fax is like sending a normal fax. Make sure that your recipient's information is saved in your email address book, and load the document you want to I-Fax into your Brother machine.



- If the computer to which you want to send a document is not running Windows Server 2012/2012 R2/2016/2019/2022, Windows 10 or Windows 11, ask the computer's owner to install software that can view TIFF files.
- To send multiple pages, use the ADF.

1. Load your document.
2. Do one of the following:
 - If the Fax Preview option is set to [Off], press [Fax].
 - If the Fax Preview option is set to [On], press [Fax], and then press [Sending Faxes].
3. To change the fax-sending settings, press  [Options].
4. Swipe up or down or press ▲ or ▼ to scroll through the fax settings. When the setting you want appears, press it and select your preference. When you have finished changing settings, press [OK]. (If the [OK] button is displayed.)
5. Do one of the following:
 - Press , enter the email address using the touchscreen, and then press [OK].
 - Press [Address Book], select the email address of your recipient, and then press [Apply].
6. Press [Fax Start].

The machine starts scanning. After the document is scanned, it is transmitted to the recipient via your SMTP server. You can cancel the send operation by pressing  during scanning.
7. Press .



Related Information

- [Fax Using the Internet \(I-Fax\)](#)

Poll the Server Manually

Related Models: MFC-L5718DN/MFC-L5728DW

1. Press  [Settings] > [All Settings] > [Network] > [E-mail] > [Manual Receive].



If your machine displays the [All Settings] menu on the Home screen, skip the [Settings] menu.

2. Press [Yes] to confirm.
3. The LCD displays [Receiving] and your machine will print the data from the email server.



Related Information

- [Fax Using the Internet \(I-Fax\)](#)

I-Fax Options

Related Models: MFC-L5718DN/MFC-L5728DW

- [Relay Broadcast](#)
- [Internet Fax \(I-Fax\) Verification Mail](#)

Relay Broadcast

Related Models: MFC-L5718DN/MFC-L5728DW

A Relay Broadcast is when your Brother machine receives a message over the Internet and then relays it to another fax machine using conventional telephone lines. If you must fax a document over a long distance or abroad, use the Relay Broadcast Function to save the communication fee.

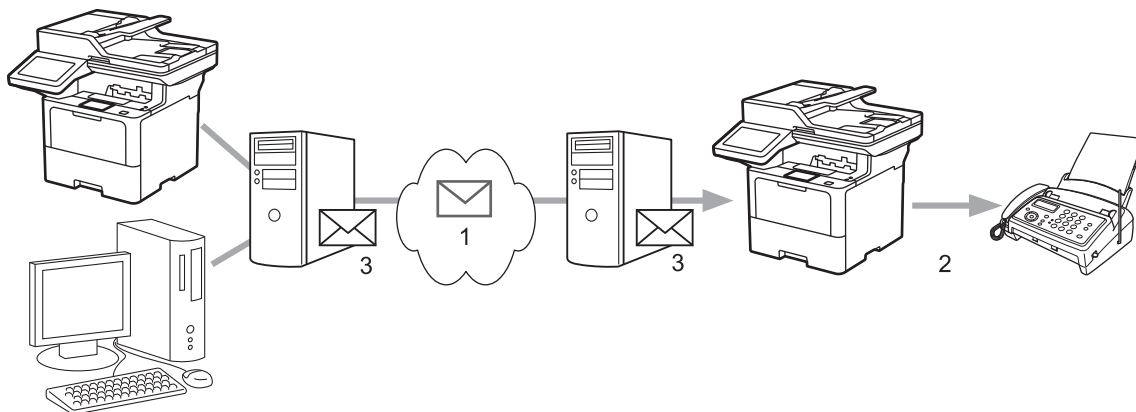

1. The Internet
2. Telephone line
3. Email server

Use the Brother machine's control panel or Web Based Management to configure the following items:

- **Relay Broadcast Function**

Set the **Relay Broadcast Function** to **On**.

- **Relay Domain**

Configure your machine's domain name on the machine that will broadcast the document to the conventional fax machine. If you wish to use your machine as a relay broadcast device, you must specify the trusted domain name (the portion of the name after the "@" sign) at the machine. Use care in selecting a trusted domain: any user on a trusted domain will be able to send a relay broadcast. You can register up to ten domain names.

- **Relay Broadcast Report**

Specify whether or not you want a report to print after the machine completes the relay broadcast.

Relay Function

Relay Broadcast Function

- Off
- On

Relay Domain

Relay Broadcast Report

- Off
- On

Cancel

Submit



Related Information

- [I-Fax Options](#)
 - [Relay Broadcast from Your Brother Machine](#)
 - [Relay Broadcast from Your Computer](#)
-

Relay Broadcast from Your Brother Machine

Related Models: MFC-L5718DN/MFC-L5728DW

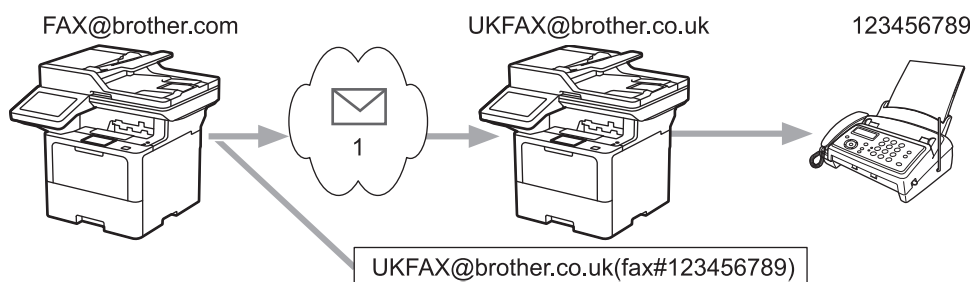

Use the Relay Broadcast Function to send an email from your machine to a conventional fax machine.

Confirm the **POP3/IMAP4/SMTP Client** and **SMTP Server** checkboxes are selected in Web Based Management. If the **POP3/IMAP4/SMTP Client** and **SMTP Server** checkboxes are not selected, select the **POP3/IMAP4/SMTP Client** and **SMTP Server** checkboxes. Click **Submit**, and then restart your machine.



1. The Internet

In this example, your machine's email address is FAX@brother.com and you want to send a document from your machine to a standard fax machine in England with the email address UKFAX@brother.co.uk, and you want your machine to send the document using a conventional telephone line.

1. Load your document.
2. Do one of the following:
 - If the Fax Preview option is set to [Off], press [Fax].
 - If the Fax Preview option is set to [On], press [Fax], and then press [Sending Faxes].
3. Press  [Options].
4. Swipe up or down or press ▲ or ▼ to display the [Broadcasting] option.
5. Press [Broadcasting].
6. Press [Add Number].
7. You can add email addresses to the broadcast in the following ways:
 - Press [Add Number] and press , enter the email address and press [OK].
 - Press [Add from Address book]. Press the checkbox of the email address you want to add to the broadcast. After you have selected all the email addresses you want, press [OK].
 - Press [Search in Address book]. Enter the name or the first letter of the name and press [OK]. The search results will be displayed. Press the name and then press the email address you want to add to the broadcast.

The following is an example of how to enter the email address and phone number:

UKFAX@brother.co.uk(fax#123456789)

email address Fax Phone Number

The word "fax#" must be included with the phone number inside the parenthesis.

After you have entered all of the fax numbers, press [OK].



If your machine displays , press it.

8. Press [Fax Start].



Related Information

- [Relay Broadcast](#)

Relay Broadcast from Your Computer

Related Models: MFC-L5718DN/MFC-L5728DW

Use the Relay Broadcast Function to send an email from your computer to a conventional fax machine.

- Some email applications do not support sending an email to multiple fax numbers. If your email application cannot support multiple fax numbers, you can relay to only one fax machine at a time.

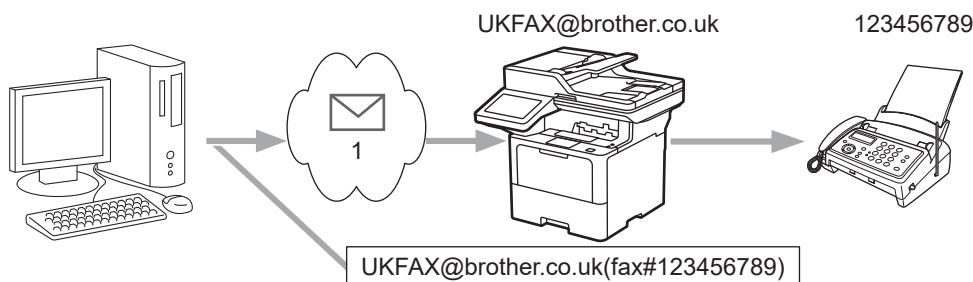

1. The Internet

- Confirm the **POP3/IMAP4/SMTP Client** and **SMTP Server** checkboxes are selected in Web Based Management. If the **POP3/IMAP4/SMTP Client** and **SMTP Server** checkboxes are not selected, select the **POP3/IMAP4/SMTP Client** and **SMTP Server** checkboxes. Click **Submit**, and then restart your machine.

If you are sending an email to a conventional fax machine, the method of entering the fax machine's fax number will vary, depending on the mail application you are using.

- In your email application, create a new email message and type the email address of the relay machine and fax number of the first fax machine in the "TO" box.

The following is an example of how to enter the email address and fax number:

UKFAX@brother.co.uk(fax#123456789)

email address Fax Phone Number

The word "fax#" must be included with the phone number inside the parenthesis.



For Microsoft Outlook, the address information must be entered into the address book as follows:

Name: fax#123456789

Email address: UKFAX@brother.co.uk

- Type the email address of the relay machine and fax number of the second fax machine in the "TO" box.
- Send the email.

✓ Related Information

- [Relay Broadcast](#)

Internet Fax (I-Fax) Verification Mail

Related Models: MFC-L5718DN/MFC-L5728DW

- Verification Mail for sending allows you to request notification from the receiving station where your I-Fax or email was received and processed.
- Verification Mail for receiving allows you to transmit a default report back to the sending station after successfully receiving and processing an I-Fax or email.

To use this feature, set the [Notification] options in the [Setup Mail RX] and [Setup Mail TX] options of your machine's control panel menu.



Related Information

- [I-Fax Options](#)
 - [Enable Send Notifications for TX Verification Mail](#)
 - [Enable Receive Notification for TX Verification Mail](#)
 - [I-Fax Error Mail](#)

Enable Send Notifications for TX Verification Mail

Related Models: MFC-L5718DN/MFC-L5728DW

1. Press  [Settings] > [All Settings] > [Network] > [E-mail/IFAX] > [Setup Mail TX] > [Notification].



If your machine displays the [All Settings] menu on the Home screen, skip the [Settings] menu.

2. Select [On] or [Off] to enable or disable the Send Notification feature.

When Send Notification is On, the fax includes an additional field, named Message Disposition Notification (MDN), that contains message delivery information. By default, Send Notification is set to Off.



Your fax recipient's machine must support the MDN field in order to send a notification report.

3. Press .



Related Information

- [Internet Fax \(I-Fax\) Verification Mail](#)

Enable Receive Notification for TX Verification Mail

Related Models: MFC-L5718DN/MFC-L5728DW

1. Press  [Settings] > [All Settings] > [Network] > [E-mail/IFAX] > [Setup Mail RX] > [Notification].



If your machine displays the [All Settings] menu on the Home screen, skip the [Settings] menu.

2. Press one of the three possible settings:

Option	Description
Receive Notification On	When Receive Notification is set to On, a template is sent back to the sender to indicate successful receipt and processing of the message. These templates depend on the operation requested by the sender. Example: SUCCESS: Received From <Mail Address>
Receive Notification MDN	When Receive Notification is set to MDN, a report to indicate successful receipt and processing is sent back to the sender if the originating station sent a request confirmation to the MDN (Message Disposition Notification) field.
Receive Notification Off	When Receive Notification is set to Off, all forms of receipt notification are disabled and no message is sent back to the sender regardless of the request.



- To send TX Verification Mail, the Sender must configure these settings:
 - Switch [Notification] in [Setup Mail TX] to [On].
 - Switch [Header] in [Setup Mail RX] to [All] or [Subject+From+To].
- To receive TX Verification Mail, the Receiver must configure these settings:
Switch [Notification] in [Setup Mail RX] to [On].

3. Press .



Related Information

- [Internet Fax \(I-Fax\) Verification Mail](#)

I-Fax Error Mail

Related Models: MFC-L5718DN/MFC-L5728DW

If there is a delivery error while sending an I-Fax, the mail server will send an error message back to the Brother machine and the error message will be printed.

If there is an error while receiving an I-Fax, an error message will be printed, for example, "The message being sent to the machine was not in a TIFF format."

To receive the error mail and have these printed on your machine, in [Setup Mail RX], switch the [Header] option to [All] or to [Subject+From+To].



Related Information

- [Internet Fax \(I-Fax\) Verification Mail](#)

Use the Send Fax to Server Feature

Related Models: MFC-L5718DN/MFC-L5728DW

The Fax to Server feature allows the machine to scan a document and send it over the network to a separate fax server. The document will then be sent from the server as fax data to the destination fax number over standard phone lines. When the Fax to Server feature is set to On, all automatic fax transmissions from the machine will be sent to the fax server for fax transmission.

You can send a fax directly from the machine using the manual fax feature when the Send to Server feature is on.



Related Information

- [Network Features](#)
 - [Before Sending a Fax to the Fax Server](#)
 - [Enable Fax to Server](#)
 - [Operate Fax to Server](#)

Enable Fax to Server

Related Models: MFC-L5718DN/MFC-L5728DW

Store the prefix/suffix address for the fax server in your Brother machine.

1. Press  [Settings] > [All Settings] > [Network] > [Fax to Server].



If your machine displays the [All Settings] menu on the Home screen, skip the [Settings] menu.

2. Press [Fax to Server].
3. Press [On].
4. Press [Prefix].
5. Enter the prefix using the touchscreen, and then press [OK].
6. Press [Suffix].
7. Enter the suffix using the touchscreen, and then press [OK].
8. Press .



Related Information

- [Use the Send Fax to Server Feature](#)

Operate Fax to Server

Related Models: MFC-L5718DN/MFC-L5728DW

1. Place the document in the ADF or on the scanner glass.
2. Do one of the following:
 - If the Fax Preview option is set to [Off], press [Fax].
 - If the Fax Preview option is set to [On], press [Fax], and then press [Sending Faxes].
3. Enter the fax number.
4. Press [Fax Start].

The machine will send the message over a TCP/IP network to the fax server.



Related Information

- [Use the Send Fax to Server Feature](#)

Configure and Operate LDAP Search

DCP-L5518DN/MFC-L5718DN/MFC-L5728DW: standard

The LDAP feature allows you to search for information, such as fax numbers and email addresses, on your server. When you use the Fax, I-Fax, or Scan to Email server feature, you can use the LDAP search to find fax numbers or email addresses.



- The LDAP feature does not support simplified Chinese, traditional Chinese, or Korean.
- The LDAP feature supports LDAPv3.
- The LDAP feature does not support SSL/TLS.



Related Information

- [Network Features](#)
 - [Change LDAP Configuration Using Web Based Management](#)
 - [Perform an LDAP Search Using Your Machine's Control Panel](#)

Change LDAP Configuration Using Web Based Management

Use Web Based Management to configure your LDAP settings in a web browser.

1. Start your web browser.
2. Type "https://machine's IP address" in your browser's address bar (where "machine's IP address" is your machine's IP address).

For example:

https://192.168.1.2

3. If required, type the password in the **Login** field, and then click **Login**.



The default password to manage this machine's settings is located on the back of the machine and marked "Pwd".

4. Go to the navigation menu, and then click **Network > Network > Protocol**.



Start from ☰, if the navigation menu is not shown on the left side of the screen.

5. Select the **LDAP** checkbox, and then click **Submit**.
6. Restart your Brother machine to activate the configuration.
7. On your computer, in Web Based Management, go to the navigation menu, and then click **Address Book > LDAP**.

- **LDAP Search**
- **LDAP Server Address**
- **SSL/TLS**
- **Port** (The default port number is 389.)
- **Authentication**
- **Username**

This selection will be available depending on the authentication method used.

- **Password**

This selection will be available depending on the authentication method used.



-
- If the LDAP server supports Kerberos authentication, we recommend selecting Kerberos for the Authentication settings. It provides strong authentication between the LDAP server and your machine.
 - You must configure the SNTP protocol (network time server), or you must set the date, time and time zone correctly on the control panel for Kerberos authentication.
-

- **Kerberos Server Address**

This selection will be available depending on the authentication method used.

- **Search Root**
- **Attribute of Card ID (Search Key)**
- **Attribute of Name**
- **Timeout for LDAP**
- **Attribute of Name (Search Key)**
- **Attribute of E-mail**
- **Attribute of Fax Number**
- **Optional Attribute**

8. When finished, click **Submit**. Make sure the **Status** field reads **OK**.



Related Information

- [Configure and Operate LDAP Search](#)

Related Topics:

- [Synchronise Time with the SNTP Server Using Web Based Management](#)
-

Perform an LDAP Search Using Your Machine's Control Panel

When you have configured LDAP settings, you can use the LDAP search feature to find fax numbers or email addresses to use for:

- Sending a Fax (not available for DCP models)
- Sending an Internet Fax (I-Fax) (not available for DCP models)
- Scanning to Email Server



- The LDAP feature supports LDAPv3.
- The LDAP feature does not support SSL/TLS.
- You may need to use Kerberos Authentication or Simple Authentication to connect to your LDAP server, depending on the security policy set by your network administrator.
- You must configure the SNTP protocol (network time server), or you must set the date, time and time zone correctly on the control panel for Kerberos authentication.

1. Press  to search.
2. Enter the initial characters for your search using the LCD.
3. Press [OK].

The LDAP search result will be shown on the LCD; the  icon appears before the fax number (local) or the email (local) address book search results.

If there is no match on the server or in the local address book, the LCD displays [Results cannot be found.] for about 60 seconds.

4. Swipe up or down or press ▲ or ▼ to display the name you want.
5. Press the name.
To view the details of the name, press [Detail].
6. If the result includes more than one fax number or email address, the machine will prompt you to select just one. Press [Apply]. Do one of the following:
 - If you are sending a fax or an I-Fax, press [Fax Start].
 - If you are scanning to the Email Server, load your document, press [Next], and then press [Start].



Related Information

- [Configure and Operate LDAP Search](#)

Related Topics:

- [Synchronise Time with the SNTP Server Using Web Based Management](#)

Synchronise Time with the SNTP Server Using Web Based Management

The Simple Network Time Protocol (SNTP) is used to synchronise the time used by the machine for authentication with the SNTP time server. (This is not the time displayed on the machine's LCD.) You can automatically or manually synchronise the machine's time with the Coordinated Universal Time (UTC) provided by the SNTP time server.

- [Configure Date and Time Using Web Based Management](#)
- [Configure the SNTP Protocol Using Web Based Management](#)
- [Change LDAP Configuration Using Web Based Management](#)
- [Perform an LDAP Search Using Your Machine's Control Panel](#)

Configure Date and Time Using Web Based Management

Configure the date and time to synchronise the time used by the machine with the SNTP time server.

This feature is not available in some countries.

1. Start your web browser.
2. Type "https://machine's IP address" in your browser's address bar (where "machine's IP address" is your machine's IP address).

For example:

https://192.168.1.2

3. If required, type the password in the **Login** field, and then click **Login**.



The default password to manage this machine's settings is located on the back of the machine and marked "Pwd".

4. Go to the navigation menu, and then click **Administrator > Date&Time**.



Start from , if the navigation menu is not shown on the left side of the screen.

5. Verify the **Time Zone** settings.



Select the time difference between your location and UTC from the **Time Zone** drop-down list. For example, the time zone for Eastern Time in the USA and Canada is UTC-05:00.

6. Select the **Synchronize with SNTP server** checkbox.
7. Click **Submit**.



You can also configure date and time manually.



Related Information

- [Synchronise Time with the SNTP Server Using Web Based Management](#)

Configure the SNTP Protocol Using Web Based Management

Configure the SNTP protocol to synchronise the time the machine uses for authentication with the time kept by the SNTP time server.

1. Start your web browser.
2. Type "https://machine's IP address" in your browser's address bar (where "machine's IP address" is your machine's IP address).

For example:

https://192.168.1.2

3. If required, type the password in the **Login** field, and then click **Login**.



The default password to manage this machine's settings is located on the back of the machine and marked "Pwd".

4. Go to the navigation menu, and then click **Network > Network > Protocol**.



Start from , if the navigation menu is not shown on the left side of the screen.

5. Select the **SNTP** checkbox to activate the settings.
6. Click **Submit**.
7. Restart your Brother machine to activate the configuration.
8. Next to the SNTP checkbox, click **Advanced Setting**.
9. Configure the settings.

Option	Description
Status	Displays whether the SNTP protocol is enabled or disabled.
Synchronization Status	Confirm the latest synchronisation status.
SNTP Server Method	Select AUTO or STATIC . <ul style="list-style-type: none">• AUTO If you have a DHCP server on your network, the SNTP server will obtain the address from that server automatically.• STATIC Type the address you want to use.
Primary SNTP Server Address Secondary SNTP Server Address	Type the server's address (up to 64 characters). The secondary SNTP server's address is used as a backup to the primary SNTP server's address. If the primary server is unavailable, the machine will contact the secondary SNTP server.
Primary SNTP Server Port Secondary SNTP Server Port	Type the port number (1-65535). The secondary SNTP server port is used as a backup to the primary SNTP server port. If the primary port is unavailable, the machine will contact the secondary SNTP port.
Synchronization Interval	Type the number of hours between server synchronisation attempts (1-168 hours).

10. Click **Submit**.



Related Information

- [Synchronise Time with the SNTP Server Using Web Based Management](#)

Gigabit Ethernet (Wired Network Only)

Your machine supports 1000BASE-T Gigabit Ethernet. To connect to a 1000BASE-T Gigabit Ethernet Network, you must set the machine's Ethernet link mode to Auto from the machine's control panel or Web Based Management (web browser).



Use a Category 5e (or greater) network cable. The machine can automatically negotiate the highest supported network speed, for example: to achieve 1000BASE-T network speeds, all connecting infrastructure, including network switches and cables must also support 1000BASE-T speeds. Otherwise the machine will communicate at either 10BASE-T or 100BASE-TX.



Related Information

- [Network Features](#)
 - [Configure the Gigabit Ethernet Settings Using Web Based Management](#)
-

Configure the Gigabit Ethernet Settings Using Web Based Management

1. Start your web browser.
2. Type "https://machine's IP address" in your browser's address bar (where "machine's IP address" is your machine's IP address).

For example:

https://192.168.1.2

3. If required, type the password in the **Login** field, and then click **Login**.



The default password to manage this machine's settings is located on the back of the machine and marked "Pwd".

4. Go to the navigation menu, and then click **Network > Wired > Ethernet**.



Start from ☰, if the navigation menu is not shown on the left side of the screen.

5. Select **Auto** from the **Ethernet Mode** drop-down list.
6. Click **Submit**.
7. To activate the settings, click **Yes** to restart your machine.

You can confirm your settings by printing the Network Configuration Report.



Related Information

- [Gigabit Ethernet \(Wired Network Only\)](#)

Related Topics:

- [Print the Network Configuration Report](#)

Reset the Network Settings to the Factory Settings

You can use your machine's control panel to reset the machine's network settings to its default factory settings. This resets all information, such as the password and IP address.



- This feature restores all network settings to the factory settings.
- You can also reset the print server to its factory settings using Web Based Management.

1. Press  [Settings] > [All Settings] > [Network] > [Network Reset].
2. [Machine will reboot after resetting. Press [OK] for 2 seconds to confirm.] appears. Press [OK] for two seconds to confirm.

The machine will restart.



Related Information

- [Network Features](#)

Related Topics:

- [Reset Your Machine](#)

Security

- [Before Using Network Security Features](#)
- [Configure Certificates for Device Security](#)
- [Use SSL/TLS](#)
- [Use SNMPv3](#)
- [Use IPsec](#)
- [Use IEEE 802.1x Authentication for a Wired or a Wireless Network](#)
- [Use Active Directory Authentication](#)
- [Use LDAP Authentication](#)
- [Use Secure Function Lock 3.0](#)
- [Send or Receive an Email Securely](#)
- [Store Print Log to Network](#)
- [Lock the Machine Settings from the Control Panel](#)
- [Use Global Network Detection Features](#)

Before Using Network Security Features

Your machine employs some of the latest network security and encryption protocols available today. These network features can be integrated into your overall network security plan to help protect your data and prevent unauthorised access to the machine.



We recommend disabling the Telnet, FTP server, and TFTP protocols. Accessing the machine using these protocols is not secure.



Related Information

- [Security](#)
 - [Network Security](#)
 - [Disable Unnecessary Protocols](#)
-

Disable Unnecessary Protocols

1. Start your web browser.
2. Type "https://machine's IP address" in your browser's address bar (where "machine's IP address" is your machine's IP address).

For example:

https://192.168.1.2

3. If required, type the password in the **Login** field, and then click **Login**.



The default password to manage this machine's settings is located on the back of the machine and marked "Pwd".

4. Go to the navigation menu, and then click **Network > Network > Protocol**.



Start from ☰, if the navigation menu is not shown on the left side of the screen.

5. Clear any unnecessary protocol check boxes to disable them.
6. Click **Submit**.
7. Restart your Brother machine to activate the configuration.



Related Information

- [Before Using Network Security Features](#)

Configure Certificates for Device Security

You must configure a certificate to manage your networked machine securely using SSL/TLS. You must use Web Based Management to configure a certificate.

- [Supported Security Certificate Features](#)
- [How to Create and Install a Certificate](#)
- [Create a Self-signed Certificate](#)
- [Create a Certificate Signing Request \(CSR\) and Install a Certificate from a Certificate Authority \(CA\)](#)
- [Import and Export the Certificate and Private Key](#)
- [Import and Export a CA Certificate](#)
- [Manage Multiple Certificates](#)

Supported Security Certificate Features

Your machine supports the use of multiple security certificates, which allows secure management, authentication, and communication with the machine. The following security certificate features can be used with the machine:

- SSL/TLS communication
- SSL communication for SMTP/POP3/IMAP4
- IEEE 802.1x authentication
- IPsec

Your machine supports the following:

- Pre-installed certificate

Your machine has a pre-installed self-signed certificate. This certificate enables you to use SSL/TLS communication without creating or installing a different certificate.



The pre-installed self-signed certificate protects your communication up to a certain level. We recommend using a certificate that is issued by a trusted organisation for better security.

- Self-signed certificate

This print server issues its own certificate. Using this certificate, you can easily use the SSL/TLS communication without creating or installing a different certificate from a CA.

- Certificate from a Certificate Authority (CA)

There are two methods for installing a certificate from a CA. If you already have a certificate from a CA or if you want to use a certificate from an external trusted CA:

- When using a Certificate Signing Request (CSR) from this print server.
- When importing a certificate and a private key.

- Certificate Authority (CA) Certificate

To use a CA certificate that identifies the CA and owns its private key, you must import that CA certificate from the CA before configuring the security features of the Network.



- If you are going to use SSL/TLS communication, we recommend contacting your system administrator first.
- When you reset the print server back to its default factory settings, the certificate and the private key that are installed will be deleted. If you want to keep the same certificate and the private key after resetting the print server, export them before resetting, and then reinstall them.



Related Information

- [Configure Certificates for Device Security](#)

How to Create and Install a Certificate

There are two options when choosing a security certificate: use a self-signed certificate or use a certificate from a Certificate Authority (CA).

Option 1

Self-Signed Certificate

1. Create a self-signed certificate using Web Based Management.
2. Install the self-signed certificate on your computer.

Option 2

Certificate from a CA

1. Create a Certificate Signing Request (CSR) using Web Based Management.
2. Install the certificate issued by the CA on your Brother machine using Web Based Management.
3. Install the certificate on your computer.



Related Information

- [Configure Certificates for Device Security](#)

Create a Self-signed Certificate

1. Start your web browser.
2. Type "https://machine's IP address" in your browser's address bar (where "machine's IP address" is your machine's IP address).

For example:

https://192.168.1.2



- If you are using a Domain Name System or enable a NetBIOS name, you can type another name, such as "SharedPrinter" instead of the IP address.

For example: https://SharedPrinter

- If you enable a NetBIOS name, you can also use the node name.

For example: https://brn123456abcdef

- The NetBIOS name can be found in the Network Configuration Report.

3. If required, type the password in the **Login** field, and then click **Login**.



The default password to manage this machine's settings is located on the back of the machine and marked "Pwd".

4. Go to the navigation menu, and then click **Network > Security > Certificate**.



Start from , if the navigation menu is not shown on the left side of the screen.

5. Click **Create Self-Signed Certificate**.
6. Enter a **Common Name** and a **Valid Date**.
 - The length of the **Common Name** is less than 64 bytes. Enter an identifier, such as an IP address, node name, or domain name to use when accessing this machine through SSL/TLS communication. The node name is displayed by default.
 - A warning will appear if you use the IPPS or HTTPS protocol and enter a different name in the URL than the **Common Name** that was used for the self-signed certificate.
7. Select your setting from the **Public Key Algorithm** drop-down list. The default setting is **RSA(2048bit)**.
8. Select your setting from the **Digest Algorithm** drop-down list. The default setting is **SHA256**.
9. Click **Submit**.



Related Information

- [Configure Certificates for Device Security](#)

Create a Certificate Signing Request (CSR) and Install a Certificate from a Certificate Authority (CA)

If you already have a certificate from an external trusted Certificate Authority (CA), you can store the certificate and private key on the machine and manage them by importing and exporting. If you do not have a certificate from an external trusted CA, create a Certificate Signing Request (CSR), send it to a CA for authentication, and install the returned certificate on your machine.

- [Create a Certificate Signing Request \(CSR\)](#)
- [Install a Certificate on Your Machine](#)

Create a Certificate Signing Request (CSR)

A Certificate Signing Request (CSR) is a request sent to a Certificate Authority (CA) to authenticate the credentials contained within the certificate.

We recommend installing a Root Certificate from the CA on your computer before creating the CSR.

1. Start your web browser.
2. Type "https://machine's IP address" in your browser's address bar (where "machine's IP address" is your machine's IP address).

For example:

https://192.168.1.2



- If you are using a Domain Name System or enable a NetBIOS name, you can type another name, such as "SharedPrinter" instead of the IP address.

For example: https://SharedPrinter

- If you enable a NetBIOS name, you can also use the node name.

For example: https://brn123456abcdef

- The NetBIOS name can be found in the Network Configuration Report.

3. If required, type the password in the **Login** field, and then click **Login**.



The default password to manage this machine's settings is located on the back of the machine and marked "Pwd".

4. Go to the navigation menu, and then click **Network > Security > Certificate**.



Start from , if the navigation menu is not shown on the left side of the screen.

5. Click **Create CSR**.
6. Type a **Common Name** (required) and add other information about your **Organization** (optional).



- Your company details are required so that a CA can confirm your identity and verify it to the outside world.
- The length of the **Common Name** must be less than 64 bytes. Enter an identifier, such as an IP address, node name, or domain name to use when accessing this machine through SSL/TLS communication. The node name is displayed by default. The **Common Name** is required.
- A warning will appear if you type a different name in the URL than the Common Name that was used for the certificate.
- The length of the **Organization**, the **Organization Unit**, the **City/Locality**, and the **State/Province** must be less than 64 bytes.
- The **Country/Region** should be a two-character ISO 3166 country code.
- If you are configuring an X.509v3 certificate extension, select the **Configure extended partition** checkbox, and then select **Auto (Register IPv4)** or **Manual**.

7. Select your setting from the **Public Key Algorithm** drop-down list. The default setting is **RSA(2048bit)**.
8. Select your setting from the **Digest Algorithm** drop-down list. The default setting is **SHA256**.
9. Click **Submit**.

The CSR appears on your screen. Save the CSR as a file or copy and paste it into an online CSR form offered by a Certificate Authority.

10. Click **Save**.



- Follow your CA's policy regarding the method to send a CSR to your CA.
 - If you are using the Enterprise root CA of Windows Server 2012/2012 R2/2016/2019/2022, we recommend using the Web Server for the certificate template to securely create the Client Certificate. If you are creating a Client Certificate for an IEEE 802.1x environment with EAP-TLS authentication, we recommend using User for the certificate template.
-



Related Information

- [Create a Certificate Signing Request \(CSR\) and Install a Certificate from a Certificate Authority \(CA\)](#)
-

Install a Certificate on Your Machine

When you receive a certificate from a Certificate Authority (CA), follow the steps below to install it on the print server:

Only a certificate issued with your machine's Certificate Signing Request (CSR) can be installed on your machine. When you want to create another CSR, make sure that the certificate is installed before creating the new CSR. Create another CSR only after installing the certificate on the machine, otherwise the CSR created before installing the new CSR will be invalid.

1. Start your web browser.
2. Type "https://machine's IP address" in your browser's address bar (where "machine's IP address" is your machine's IP address).

For example:

https://192.168.1.2



- If you are using a Domain Name System or enable a NetBIOS name, you can type another name, such as "SharedPrinter" instead of the IP address.

For example: https://SharedPrinter

- If you enable a NetBIOS name, you can also use the node name.

For example: https://brn123456abcdef

- The NetBIOS name can be found in the Network Configuration Report.

3. If required, type the password in the **Login** field, and then click **Login**.



The default password to manage this machine's settings is located on the back of the machine and marked "Pwd".

4. Go to the navigation menu, and then click **Network > Security > Certificate**.



Start from , if the navigation menu is not shown on the left side of the screen.

5. Click **Install Certificate**.
6. Browse to the file that contains the certificate issued by the CA, and then click **Submit**.

The certificate has been created and saved in your machine's memory successfully.

To use SSL/TLS communication, the Root Certificate from the CA must be installed on your computer. Contact your network administrator.



Related Information

- [Create a Certificate Signing Request \(CSR\) and Install a Certificate from a Certificate Authority \(CA\)](#)

Import and Export the Certificate and Private Key

Store the certificate and private key on your machine and manage them by importing and exporting them.

- [Import a Certificate and Private Key](#)
- [Export the Certificate and Private Key](#)

Import a Certificate and Private Key

1. Start your web browser.
2. Type "https://machine's IP address" in your browser's address bar (where "machine's IP address" is your machine's IP address).

For example:

https://192.168.1.2



- If you are using a Domain Name System or enable a NetBIOS name, you can type another name, such as "SharedPrinter" instead of the IP address.

For example: https://SharedPrinter

- If you enable a NetBIOS name, you can also use the node name.

For example: https://brn123456abcdef

- The NetBIOS name can be found in the Network Configuration Report.

3. If required, type the password in the **Login** field, and then click **Login**.



The default password to manage this machine's settings is located on the back of the machine and marked "Pwd".

4. Go to the navigation menu, and then click **Network > Security > Certificate**.



Start from ☰, if the navigation menu is not shown on the left side of the screen.

5. Click **Import Certificate and Private Key**.
6. Browse to the file you want to import.
7. Type the password if the file is encrypted, and then click **Submit**.

The certificate and private key are imported to your machine.



Related Information

- [Import and Export the Certificate and Private Key](#)

Export the Certificate and Private Key

1. Start your web browser.
2. Type "https://machine's IP address" in your browser's address bar (where "machine's IP address" is your machine's IP address).

For example:

https://192.168.1.2



- If you are using a Domain Name System or enable a NetBIOS name, you can type another name, such as "SharedPrinter" instead of the IP address.

For example: https://SharedPrinter

- If you enable a NetBIOS name, you can also use the node name.

For example: https://brn123456abcdef

- The NetBIOS name can be found in the Network Configuration Report.

3. If required, type the password in the **Login** field, and then click **Login**.



The default password to manage this machine's settings is located on the back of the machine and marked "Pwd".

4. Go to the navigation menu, and then click **Network > Security > Certificate**.



Start from , if the navigation menu is not shown on the left side of the screen.

5. Click **Export** shown with **Certificate List**.
6. Enter the password if you want to encrypt the file.
If a blank password is used, the output is not encrypted.
7. Enter the password again for confirmation, and then click **Submit**.
8. Click **Save**.

The certificate and private key are exported to your computer.

You can also import the certificate to your computer.



Related Information

- [Import and Export the Certificate and Private Key](#)

Import and Export a CA Certificate

You can import, export, and store CA certificates on your Brother machine.

- [Import a CA Certificate](#)
- [Export a CA Certificate](#)

Import a CA Certificate

1. Start your web browser.
2. Type "https://machine's IP address" in your browser's address bar (where "machine's IP address" is your machine's IP address).

For example:

https://192.168.1.2



- If you are using a Domain Name System or enable a NetBIOS name, you can type another name, such as "SharedPrinter" instead of the IP address.

For example: https://SharedPrinter

- If you enable a NetBIOS name, you can also use the node name.

For example: https://brn123456abcdef

- The NetBIOS name can be found in the Network Configuration Report.

3. If required, type the password in the **Login** field, and then click **Login**.



The default password to manage this machine's settings is located on the back of the machine and marked "Pwd".

4. Go to the navigation menu, and then click **Network > Security > CA Certificate**.



Start from ☰, if the navigation menu is not shown on the left side of the screen.

5. Click **Import CA Certificate**.
6. Browse to the file you want to import.
7. Click **Submit**.



Related Information

- [Import and Export a CA Certificate](#)

Export a CA Certificate

1. Start your web browser.
2. Type "https://machine's IP address" in your browser's address bar (where "machine's IP address" is your machine's IP address).

For example:

https://192.168.1.2



- If you are using a Domain Name System or enable a NetBIOS name, you can type another name, such as "SharedPrinter" instead of the IP address.

For example: https://SharedPrinter

- If you enable a NetBIOS name, you can also use the node name.

For example: https://brn123456abcdef

- The NetBIOS name can be found in the Network Configuration Report.

3. If required, type the password in the **Login** field, and then click **Login**.



The default password to manage this machine's settings is located on the back of the machine and marked "Pwd".

4. Go to the navigation menu, and then click **Network > Security > CA Certificate**.



Start from ☰, if the navigation menu is not shown on the left side of the screen.

5. Select the certificate you want to export and click **Export**.
6. Click **Submit**.
7. Click ▼ next to **Save**, and then specify the location where you want to save the file.



Related Information

- [Import and Export a CA Certificate](#)

Manage Multiple Certificates

The multiple certificate feature allows you to use Web Based Management to manage each certificate installed on your machine. In Web Based Management, navigate to the **Certificate** or **CA Certificate** screen to view certificate content, delete, or export your certificates.

	Maximum Number of Certificates Stored on Brother Machine
Self-signed Certificate or Certificate Issued by a CA	6
CA Certificate	9

We recommend storing fewer certificates than allowed, reserving an empty spot in case of certificate expiration. When a certificate expires, import a new certificate into the reserved spot, and then delete the expired certificate. This ensures that you avoid configuration failure.



- When you use HTTPS/IPPS, IEEE 802.1x, or Signed PDF, you must select which certificate you are using.
- When you use SSL for SMTP/POP3/IMAP4 communications, you do not have to choose the certificate. The necessary certificate will be chosen automatically.



Related Information

- [Configure Certificates for Device Security](#)

Use SSL/TLS

- [Introduction to SSL/TLS](#)
- [Manage Your Network Machine Securely Using SSL/TLS](#)
- [Print Documents Securely Using SSL/TLS](#)
- [Send or Receive an Email Securely](#)

Introduction to SSL/TLS

Secure Socket Layer (SSL) or Transport Layer Security (TLS) is an effective method of protecting data sent over a local or wide area network (LAN or WAN). It works by encrypting data, such as a print job, sent over a network, so anyone trying to capture it will not be able to read it.

SSL/TLS can be configured on both wired and wireless networks and will work with other forms of security such as WPA keys and firewalls.



Related Information

- [Use SSL/TLS](#)
 - [Brief History of SSL/TLS](#)
 - [Benefits of Using SSL/TLS](#)
-

Brief History of SSL/TLS

SSL/TLS was originally created to secure web traffic information, particularly data sent between web browsers and servers. SSL is now used with additional applications, such as Telnet, printer, and FTP software, in order to become a universal solution for online security. Its original design intentions are still being used today by many online retailers and banks to secure sensitive data, such as credit card numbers, customer records, etc.

SSL/TLS uses extremely high levels of encryption and is trusted by banks all over the world.



Related Information

- [Introduction to SSL/TLS](#)
-

Benefits of Using SSL/TLS

The primary benefit of using SSL/TLS is to guarantee secure printing over an IP network by restricting unauthorised users from reading data sent to the machine. SSL's most important benefit is that it can be used to print confidential data securely. For example, a Human Resource (HR) Department in a large company may be printing wage slips on a regular basis. Without encryption, the data contained on these wages slips can be read by other network users. However, with SSL/TLS, anyone trying to capture the data will see a page of code and not the actual wage slip.



Related Information

- [Introduction to SSL/TLS](#)

Manage Your Network Machine Securely Using SSL/TLS

- [Configure a Certificate for SSL/TLS and Available Protocols](#)
- [Access Web Based Management Using SSL/TLS](#)
- [Install the Self-signed Certificate for Windows Users as Administrator](#)
- [Configure Certificates for Device Security](#)

Configure a Certificate for SSL/TLS and Available Protocols

Configure a certificate on your machine using Web Based Management before you use SSL/TLS communication.

1. Start your web browser.
2. Type "https://machine's IP address" in your browser's address bar (where "machine's IP address" is your machine's IP address).

For example:

https://192.168.1.2



- If you are using a Domain Name System or enable a NetBIOS name, you can type another name, such as "SharedPrinter" instead of the IP address.

For example: https://SharedPrinter

- If you enable a NetBIOS name, you can also use the node name.

For example: https://brn123456abcdef

- The NetBIOS name can be found in the Network Configuration Report.

3. If required, type the password in the **Login** field, and then click **Login**.



The default password to manage this machine's settings is located on the back of the machine and marked "Pwd".

4. Go to the navigation menu, and then click **Network > Network > Protocol**.



Start from ☰, if the navigation menu is not shown on the left side of the screen.

5. Click **HTTP Server Settings**.
6. Select the certificate you want to configure from the **Select the Certificate** drop-down list.
7. Click **Submit**.
8. Click **Yes** to restart your print server.



Related Information

- [Manage Your Network Machine Securely Using SSL/TLS](#)

Access Web Based Management Using SSL/TLS

To manage your network machine securely, use Web Based Management with the HTTPS protocol.



- To use HTTPS protocol, HTTPS must be enabled on your machine. The HTTPS protocol is enabled by default.
- You can change the HTTPS protocol settings using Web Based Management.

1. Start your web browser.
2. Type "https://Common Name" in your browser's address bar (where "Common Name" is the Common Name that you assigned to the certificate; this could be your IP address, node name, or domain name).
3. If required, type the password in the **Login** field, and then click **Login**.



The default password to manage this machine's settings is located on the back of the machine and marked "Pwd".

4. You can now access the machine using HTTPS.



Related Information

- [Manage Your Network Machine Securely Using SSL/TLS](#)

Install the Self-signed Certificate for Windows Users as Administrator

- The following steps are for Microsoft Edge. If you use another web browser, refer to your web browser's documentation or online help for instructions on how to install certificates.
- Make sure you have created your self-signed certificate using Web Based Management.

1. Right-click the **Microsoft Edge** icon, and then click **Run as administrator**.

If the **User Account Control** screen appears, click **Yes**.

2. Type "https://machine's IP address" in your browser's address bar (where "machine's IP address" is your machine's IP address).

For example:

https://192.168.1.2



- If you are using a Domain Name System or enable a NetBIOS name, you can type another name, such as "SharedPrinter" instead of the IP address.

For example: https://SharedPrinter

- If you enable a NetBIOS name, you can also use the node name.

For example: https://brn123456abcdef

- The NetBIOS name can be found in the Network Configuration Report.

3. If your connection is not private, click the **Advanced** button, and then continue to the web page.
4. If required, type the password in the **Login** field, and then click **Login**.



The default password to manage this machine's settings is located on the back of the machine and marked "Pwd".

5. Go to the navigation menu, and then click **Network > Security > Certificate**.



Start from , if the navigation menu is not shown on the left side of the screen.

6. Click **Export**.
7. To encrypt the output file, type a password in the **Enter password** field. If the **Enter password** field is blank, your output file will not be encrypted.
8. Type the password again in the **Retype password** field, and then click **Submit**.
9. Click the downloaded file to open it.
10. When the **Certificate Import Wizard** appears, click **Next**.
11. Click **Next**.
12. If required, type a password, and then click **Next**.
13. Select **Place all certificates in the following store**, and then click **Browse...**
14. Select the **Trusted Root Certification Authorities**, and then click **OK**.
15. Click **Next**.
16. Click **Finish**.
17. Click **Yes**, if the fingerprint (thumbprint) is correct.
18. Click **OK**.



Related Information

- [Manage Your Network Machine Securely Using SSL/TLS](#)

Print Documents Securely Using SSL/TLS

- [Print Documents Using IPPS](#)
- [Configure a Certificate for SSL/TLS and Available Protocols](#)
- [Configure Certificates for Device Security](#)

Print Documents Using IPPS

To print documents securely with IPP protocol, use the IPPS protocol.

1. Start your web browser.
2. Type "https://machine's IP address" in your browser's address bar (where "machine's IP address" is your machine's IP address).

For example:

https://192.168.1.2



- If you are using a Domain Name System or enable a NetBIOS name, you can type another name, such as "SharedPrinter" instead of the IP address.

For example: https://SharedPrinter

- If you enable a NetBIOS name, you can also use the node name.

For example: https://brn123456abcdef

- The NetBIOS name can be found in the Network Configuration Report.

3. If required, type the password in the **Login** field, and then click **Login**.



The default password to manage this machine's settings is located on the back of the machine and marked "Pwd".

4. Go to the navigation menu, and then click **Network > Network > Protocol**.



Start from , if the navigation menu is not shown on the left side of the screen.

5. Make sure the **IPP** checkbox is selected.



If the **IPP** checkbox is not selected, select the **IPP** checkbox, and then click **Submit**.

Restart your machine to activate the configuration.

After the machine restarts, return to the machine's web page, type the password, go to the navigation menu, and then click **Network > Network > Protocol**.

6. Click **HTTP Server Settings**.
7. Select the **HTTPS** checkbox in the **IPP** area, and then click **Submit**.
8. Restart your machine to activate the configuration.

Communication using IPPS cannot prevent unauthorised access to the print server.



Related Information

- [Print Documents Securely Using SSL/TLS](#)

Use SNMPv3

- [Manage Your Network Machine Securely Using SNMPv3](#)

Manage Your Network Machine Securely Using SNMPv3

The Simple Network Management Protocol version 3 (SNMPv3) provides user authentication and data encryption to manage network devices securely.

1. Start your web browser.
2. Type "https://Common Name" in your browser's address bar (where "Common Name" is the Common Name that you assigned to the certificate; this could be your IP address, node name, or domain name).
3. If required, type the password in the **Login** field, and then click **Login**.





The default password to manage this machine's settings is located on the back of the machine and marked "Pwd".

4. Go to the navigation menu, and then click **Network > Network > Protocol**.



Start from , if the navigation menu is not shown on the left side of the screen.

5. Make sure the **SNMP** setting is enabled, and then click **Advanced Setting**.
6. Configure the SNMP settings.

Option	Description
SNMP v1/v2c read-write access	The print server uses version 1 and version 2c of the SNMP protocol. You can use all of your machine's applications in this mode. However, it is not secure since it will not authenticate the user and data will not be encrypted.
SNMPv3 read-write access and v1/v2c read-only access	<p>The print server uses the read-write access of version 3 and the read-only access of version 1 and version 2c of the SNMP protocol.</p> <p> When you use the SNMPv3 read-write access and v1/v2c read-only access mode, some of your machine's applications that access the print server do not work correctly since they authorize the read-only access of version 1 and version 2c. If you want to use all applications, we recommend using the SNMP v1/v2c read-write access mode.</p>
SNMPv3 read-write access	<p>The print server uses version 3 of the SNMP protocol. If you want to manage the print server securely, use this mode.</p> <p> When you use the SNMPv3 read-write access mode, note the following: Except for BRAdmin Professional, all applications that use SNMPv1/v2c will be restricted. To allow the use of SNMPv1/v2c applications, use the SNMPv3 read-write access and v1/v2c read-only access or SNMP v1/v2c read-write access mode.</p>

7. Click **Submit**.



If your machine displays the protocol setting options, select the options you want.

8. Restart your machine to activate the configuration.



Related Information

- [Use SNMPv3](#)

Use IPsec

- [Introduction to IPsec](#)
- [Configure IPsec Using Web Based Management](#)
- [Configure an IPsec Address Template Using Web Based Management](#)
- [Configure an IPsec Template Using Web Based Management](#)

Introduction to IPsec

IPsec (Internet Protocol Security) is a security protocol that uses an optional Internet Protocol function to prevent data manipulation and ensure the confidentiality of data transmitted as IP packets. IPsec encrypts data carried over a network, such as print data sent from computers to a printer. Because the data is encrypted at the network layer, applications that employ a higher-level protocol use IPsec even if the user is not aware of its use.

IPsec supports the following functions:

- IPsec transmissions

According to the IPsec setting conditions, a network-connected computer sends data to and receives data from a specified device using IPsec. When devices start communicating using IPsec, keys are exchanged using Internet Key Exchange (IKE) first, and then the encrypted data is transmitted using the keys.

In addition, IPsec has two operation modes: the Transport mode and Tunnel mode. The Transport mode is used mainly for communication between devices and the Tunnel mode is used in environments such as a Virtual Private Network (VPN).



For IPsec transmissions, the following conditions are necessary:

- A computer that can communicate using IPsec is connected to the network.
 - Your machine is configured for IPsec communication.
 - The computer connected to your machine is configured for IPsec connections.
-

- IPsec settings

The settings that are necessary for connections using IPsec. These settings can be configured using Web Based Management.



To configure the IPsec settings, you must use the browser on a computer that is connected to the network.



Related Information

- [Use IPsec](#)
-

Configure IPsec Using Web Based Management

The IPsec connection conditions comprise two **Template** types: **Address** and **IPsec**. You can configure up to 10 connection conditions.

1. Start your web browser.
2. Type "https://machine's IP address" in your browser's address bar (where "machine's IP address" is your machine's IP address).

For example:

https://192.168.1.2

3. If required, type the password in the **Login** field, and then click **Login**.



The default password to manage this machine's settings is located on the back of the machine and marked "Pwd".

4. Go to the navigation menu, and then click **Network > Security > IPsec**.



Start from , if the navigation menu is not shown on the left side of the screen.

5. Configure the settings.

Option	Description
Status	Enable or disable IPsec.
Negotiation Mode	Select Negotiation Mode for IKE Phase 1. IKE is a protocol that is used to exchange encryption keys in order to carry out encrypted communication using IPsec. In the Main mode, the processing speed is slow, but the security is high. In the Aggressive mode, the processing speed is faster than in the Main mode, but the security is lower.
All Non-IPsec Traffic	Select the action to be taken for non-IPsec packets. When using Web Services, you must select Allow for All Non-IPsec Traffic . If you select Drop , Web Services cannot be used.
Broadcast/Multicast Bypass	Select Enabled or Disabled .
Protocol Bypass	Select the checkboxes for the option or options you want.
Rules	Select the Enabled checkbox to activate the template. When you select multiple checkboxes, the lower numbered checkboxes have priority if the settings for the selected checkboxes conflict. Click the corresponding drop-down list to select the Address Template that is used for the IPsec connection conditions. To add an Address Template , click Add Template . Click the corresponding drop-down list to select the IPsec Template that is used for the IPsec connection conditions. To add an IPsec Template , click Add Template .

6. Click **Submit**.

If the machine must be restarted to activate the new settings, the restart confirmation screen will appear.

If there is a blank item in the template you enabled in the **Rules** table, an error message appears. Confirm your choices and click **Submit** again.



Related Information

- [Use IPsec](#)

Related Topics:

- [Configure Certificates for Device Security](#)

Configure an IPsec Address Template Using Web Based Management

1. Start your web browser.
2. Type "https://machine's IP address" in your browser's address bar (where "machine's IP address" is your machine's IP address).

For example:

https://192.168.1.2

3. If required, type the password in the **Login** field, and then click **Login**.



The default password to manage this machine's settings is located on the back of the machine and marked "Pwd".

4. Go to the navigation menu, and then click **Network > Security > IPsec Address Template**.



Start from ☰, if the navigation menu is not shown on the left side of the screen.

5. Click the **Delete** button to delete an **Address Template**. When an **Address Template** is in use, it cannot be deleted.
6. Click the **Address Template** that you want to create. The **IPsec Address Template** appears.
7. Configure the settings.

Option	Description
Template Name	Type a name for the template (up to 16 characters).
Local IP Address	<ul style="list-style-type: none"> • IP Address Specify the IP address. Select ALL IPv4 Address, ALL IPv6 Address, ALL Link Local IPv6, or Custom from the drop-down list. If you select Custom from the drop-down list, type the IP address (IPv4 or IPv6) in the text box. • IP Address Range Type the starting and ending IP addresses for the IP address range in the text boxes. If the starting and ending IP addresses are not standardised to IPv4 or IPv6, or the ending IP address is smaller than the starting address, an error will occur. • IP Address / Prefix Specify the IP address using CIDR notation. For example: 192.168.1.1/24 Because the prefix is specified in the form of a 24-bit subnet mask (255.255.255.0) for 192.168.1.1, the addresses 192.168.1.### are valid.
Remote IP Address	<ul style="list-style-type: none"> • Any If you select Any, all IP addresses are enabled. • IP Address Type the specified IP address (IPv4 or IPv6) in the text box. • IP Address Range Type the first and last IP addresses for the IP address range. If the first and last IP addresses are not standardised to IPv4 or IPv6, or the last IP address is smaller than the first address, an error will occur. • IP Address / Prefix Specify the IP address using CIDR notation. For example: 192.168.1.1/24

Option	Description
	Because the prefix is specified in the form of a 24-bit subnet mask (255.255.255.0) for 192.168.1.1, the addresses 192.168.1.### are valid.

8. Click **Submit**.



When you change the settings for the template currently in use, restart your machine to activate the configuration.



Related Information

- [Use IPsec](#)
-

Configure an IPsec Template Using Web Based Management

1. Start your web browser.
2. Type "https://machine's IP address" in your browser's address bar (where "machine's IP address" is your machine's IP address).

For example:

https://192.168.1.2

3. If required, type the password in the **Login** field, and then click **Login**.



The default password to manage this machine's settings is located on the back of the machine and marked "Pwd".

4. Go to the navigation menu, and then click **Network > Security > IPsec Template**.



Start from ☰, if the navigation menu is not shown on the left side of the screen.

5. Click the **Delete** button to delete an **IPsec Template**. When an **IPsec Template** is in use, it cannot be deleted.
6. Click the **IPsec Template** that you want to create. The **IPsec Template** screen appears. The configuration fields differ based on the **Use Prefixed Template** and **Internet Key Exchange (IKE)** settings you select.
7. In the **Template Name** field, type a name for the template (up to 16 characters).
8. If you selected **Custom** in the **Use Prefixed Template** drop-down list, select the **Internet Key Exchange (IKE)** options, and then change the settings if needed.
9. Click **Submit**.





Related Information

- [Use IPsec](#)
 - [IKEv1 Settings for an IPsec Template](#)
 - [IKEv2 Settings for an IPsec Template](#)
 - [Manual Settings for an IPsec Template](#)

IKEv1 Settings for an IPsec Template

Option	Description
Template Name	Type a name for the template (up to 16 characters).
Use Prefixed Template	Select Custom , IKEv1 High Security or IKEv1 Medium Security . The setting items are different depending on the selected template.
Internet Key Exchange (IKE)	<p>IKE is a communication protocol that is used to exchange encryption keys in order to carry out encrypted communication using IPsec. To carry out encrypted communication for that time only, the encryption algorithm that is necessary for IPsec is determined and the encryption keys are shared. For IKE, the encryption keys are exchanged using the Diffie-Hellman key exchange method, and encrypted communication that is limited to IKE is carried out.</p> <p>If you selected Custom in Use Prefixed Template, select IKEv1.</p>
Authentication Type	<ul style="list-style-type: none"> • Diffie-Hellman Group <p>This key exchange method allows secret keys to be securely exchanged over an unprotected network. The Diffie-Hellman key exchange method uses a discrete logarithm problem, not the secret key, to send and receive open information that was generated using a random number and the secret key.</p> <p>Select Group1, Group2, Group5, or Group14.</p> • Encryption <p>Select DES, 3DES, AES-CBC 128, or AES-CBC 256.</p> • Hash <p>Select MD5, SHA1, SHA256, SHA384 or SHA512.</p> • SA Lifetime <p>Specify the IKE SA lifetime.</p> <p>Type the time (seconds) and number of kilobytes (KByte).</p>
Encapsulating Security	<ul style="list-style-type: none"> • Protocol <p>Select ESP, AH, or AH+ESP.</p> <hr/> <ul style="list-style-type: none"> -  ESP is a protocol for carrying out encrypted communication using IPsec. ESP encrypts the payload (communicated contents) and adds additional information. The IP packet comprises the header and the encrypted payload, which follows the header. In addition to the encrypted data, the IP packet also includes information regarding the encryption method and encryption key, the authentication data, and so on. - AH is part of the IPsec protocol that authenticates the sender and prevents manipulation (ensures the completeness) of the data. In the IP packet, the data is inserted immediately after the header. In addition, the packets include hash values, which are calculated using an equation from the communicated contents, secret key, and so on, in order to prevent the falsification of the sender and manipulation of the data. Unlike ESP, the communicated contents are not encrypted, and the data is sent and received as plain text. <hr/> • Encryption (Not available for the AH option.) <p>Select DES, 3DES, AES-CBC 128, or AES-CBC 256.</p> • Hash <p>Select None, MD5, SHA1, SHA256, SHA384, or SHA512.</p> <p>None can be selected only when ESP is selected in Protocol.</p>



Option	Description
	<ul style="list-style-type: none"> • SA Lifetime Specify the IKE SA lifetime. Type the time (seconds) and number of kilobytes (KByte). • Encapsulation Mode Select Transport or Tunnel. • Remote Router IP-Address Type the IP address (IPv4 or IPv6) of the remote router. Enter this information only when the Tunnel mode is selected. <hr/>  SA (Security Association) is an encrypted communication method using IPsec or IPv6 that exchanges and shares information, such as the encryption method and encryption key, in order to establish a secure communication channel before communication begins. SA may also refer to a virtual encrypted communication channel that has been established. The SA used for IPsec establishes the encryption method, exchanges the keys, and carries out mutual authentication according to the IKE (Internet Key Exchange) standard procedure. In addition, the SA is updated periodically.
Perfect Forward Secrecy (PFS)	<p>PFS does not derive keys from previous keys that were used to encrypt messages. In addition, if a key that is used to encrypt a message was derived from a parent key, that parent key is not used to derive other keys. Therefore, even if a key is compromised, the damage will be limited only to the messages that were encrypted using that key.</p> <p>Select Enabled or Disabled.</p>
Authentication method.	<p>Select the authentication method. Select Pre-Shared Key or Certificates.</p>
Pre-Shared Key	<p>When encrypting communication, the encryption key is exchanged and shared beforehand using another channel.</p> <p>If you selected Pre-Shared Key for the Authentication method., type the Pre-Shared Key (up to 32 characters).</p> <ul style="list-style-type: none"> • Local/ID Type/ID Select the sender's ID type, and then type the ID. Select IPv4 Address, IPv6 Address, FQDN, E-mail Address, or Certificate for the type. If you select Certificate, type the common name of the certificate in the ID field. • Remote/ID Type/ID Select the recipient's ID type, and then type the ID. Select IPv4 Address, IPv6 Address, FQDN, E-mail Address, or Certificate for the type. If you select Certificate, type the common name of the certificate in the ID field.
Certificate	<p>If you selected Certificates for Authentication method., select the certificate.</p> <hr/>  You can select only the certificates that were created using the Certificate page of Web Based Management's Security configuration screen.

Related Information

- [Configure an IPsec Template Using Web Based Management](#)

IKEv2 Settings for an IPsec Template

Option	Description
Template Name	Type a name for the template (up to 16 characters).
Use Prefixed Template	Select Custom , IKEv2 High Security , or IKEv2 Medium Security . The setting items are different depending on the selected template.
Internet Key Exchange (IKE)	IKE is a communication protocol that is used to exchange encryption keys in order to carry out encrypted communication using IPsec. To carry out encrypted communication for that time only, the encryption algorithm that is necessary for IPsec is determined and the encryption keys are shared. For IKE, the encryption keys are exchanged using the Diffie-Hellman key exchange method, and encrypted communication that is limited to IKE is carried out. If you selected Custom in Use Prefixed Template , select IKEv2 .
Authentication Type	<ul style="list-style-type: none"> • Diffie-Hellman Group This key exchange method allows secret keys to be securely exchanged over an unprotected network. The Diffie-Hellman key exchange method uses a discrete logarithm problem, not the secret key, to send and receive open information that was generated using a random number and the secret key. Select Group1, Group2, Group5, or Group14. • Encryption Select DES, 3DES, AES-CBC 128, or AES-CBC 256. • Hash Select MD5, SHA1, SHA256, SHA384 or SHA512. • SA Lifetime Specify the IKE SA lifetime. Type the time (seconds) and number of kilobytes (KByte).
Encapsulating Security	<ul style="list-style-type: none"> • Protocol Select ESP.  ESP is a protocol for carrying out encrypted communication using IPsec. ESP encrypts the payload (communicated contents) and adds additional information. The IP packet comprises the header and the encrypted payload, which follows the header. In addition to the encrypted data, the IP packet also includes information regarding the encryption method and encryption key, the authentication data, and so on. • Encryption Select DES, 3DES, AES-CBC 128, or AES-CBC 256. • Hash Select MD5, SHA1, SHA256, SHA384, or SHA512. • SA Lifetime Specify the IKE SA lifetime. Type the time (seconds) and number of kilobytes (KByte). • Encapsulation Mode Select Transport or Tunnel. • Remote Router IP-Address Type the IP address (IPv4 or IPv6) of the remote router. Enter this information only when the Tunnel mode is selected.

Option	Description
	 <p>SA (Security Association) is an encrypted communication method using IPsec or IPv6 that exchanges and shares information, such as the encryption method and encryption key, in order to establish a secure communication channel before communication begins. SA may also refer to a virtual encrypted communication channel that has been established. The SA used for IPsec establishes the encryption method, exchanges the keys, and carries out mutual authentication according to the IKE (Internet Key Exchange) standard procedure. In addition, the SA is updated periodically.</p>
Perfect Forward Secrecy (PFS)	<p>PFS does not derive keys from previous keys that were used to encrypt messages. In addition, if a key that is used to encrypt a message was derived from a parent key, that parent key is not used to derive other keys. Therefore, even if a key is compromised, the damage will be limited only to the messages that were encrypted using that key.</p> <p>Select Enabled or Disabled.</p>
Authentication method.	<p>Select the authentication method. Select Pre-Shared Key, Certificates, EAP - MD5, or EAP - MS-CHAPv2.</p>  <p>EAP is an authentication protocol that is an extension of PPP. By using EAP with IEEE802.1x, a different key is used for user authentication during each session.</p> <p>The following settings are necessary only when EAP - MD5 or EAP - MS-CHAPv2 is selected in Authentication method:</p> <ul style="list-style-type: none"> • Mode Select Server-Mode or Client-Mode. • Certificate Select the certificate. • User Name Type the user name (up to 32 characters). • Password Type the password (up to 32 characters). The password must be entered two times for confirmation.
Pre-Shared Key	<p>When encrypting communication, the encryption key is exchanged and shared beforehand using another channel.</p> <p>If you selected Pre-Shared Key for the Authentication method., type the Pre-Shared Key (up to 32 characters).</p> <ul style="list-style-type: none"> • Local/ID Type/ID Select the sender's ID type, and then type the ID. Select IPv4 Address, IPv6 Address, FQDN, E-mail Address, or Certificate for the type. If you select Certificate, type the common name of the certificate in the ID field. • Remote/ID Type/ID Select the recipient's ID type, and then type the ID. Select IPv4 Address, IPv6 Address, FQDN, E-mail Address, or Certificate for the type. If you select Certificate, type the common name of the certificate in the ID field.
Certificate	<p>If you selected Certificates for Authentication method., select the certificate.</p>



Option	Description
	 You can select only the certificates that were created using the Certificate page of Web Based Management's Security configuration screen.





Related Information

- [Configure an IPsec Template Using Web Based Management](#)
-

Manual Settings for an IPsec Template

Option	Description
Template Name	Type a name for the template (up to 16 characters).
Use Prefixed Template	Select Custom .
Internet Key Exchange (IKE)	<p>IKE is a communication protocol that is used to exchange encryption keys in order to carry out encrypted communication using IPsec. To carry out encrypted communication for that time only, the encryption algorithm that is necessary for IPsec is determined and the encryption keys are shared. For IKE, the encryption keys are exchanged using the Diffie-Hellman key exchange method, and encrypted communication that is limited to IKE is carried out.</p> <p>Select Manual.</p>
Authentication Key (ESP, AH)	<p>Type the In/Out values.</p> <p>These settings are necessary when Custom is selected for Use Prefixed Template, Manual is selected for Internet Key Exchange (IKE), and a setting other than None is selected for Hash for Encapsulating Security section.</p> <hr/> <p> The number of characters you can set differs depending on the setting you chose for Hash in the Encapsulating Security section.</p> <p>If the length of the specified authentication key is different than the selected hash algorithm, an error will occur.</p> <ul style="list-style-type: none"> • MD5: 128 bits (16 bytes) • SHA1: 160 bits (20 bytes) • SHA256: 256 bits (32 bytes) • SHA384: 384 bits (48 bytes) • SHA512: 512 bits (64 bytes) <p>When you specify the key in ASCII Code, enclose the characters in double quotation marks (").</p> <hr/>
Code key (ESP)	<p>Type the In/Out values.</p> <p>These settings are necessary when Custom is selected in Use Prefixed Template, Manual is selected in Internet Key Exchange (IKE), and ESP is selected in Protocol in Encapsulating Security.</p> <hr/> <p> The number of characters you can set differs depending on the setting you chose for Encryption in the Encapsulating Security section.</p> <p>If the length of the specified code key is different than the selected encryption algorithm, an error will occur.</p> <ul style="list-style-type: none"> • DES: 64 bits (8 bytes) • 3DES: 192 bits (24 bytes) • AES-CBC 128: 128 bits (16 bytes) • AES-CBC 256: 256 bits (32 bytes) <p>When you specify the key in ASCII Code, enclose the characters in double quotation marks (").</p> <hr/>
SPI	<p>These parameters are used to identify security information. Generally, a host has multiple Security Associations (SAs) for several types of IPsec communication. Therefore, it is necessary to identify the applicable SA when an IPsec packet is received. The SPI parameter, which identifies the SA, is included in the Authentication Header (AH) and Encapsulating Security Payload (ESP) header.</p>

Option	Description
	<p>These settings are necessary when Custom is selected for Use Prefixed Template, and Manual is selected for Internet Key Exchange (IKE).</p> <p>Enter the In/Out values. (3-10 characters)</p>
<p>Encapsulating Security</p>	<ul style="list-style-type: none"> • Protocol Select ESP or AH. <hr/> <ul style="list-style-type: none">  <ul style="list-style-type: none"> - ESP is a protocol for carrying out encrypted communication using IPsec. ESP encrypts the payload (communicated contents) and adds additional information. The IP packet comprises the header and the encrypted payload, which follows the header. In addition to the encrypted data, the IP packet also includes information regarding the encryption method and encryption key, the authentication data, and so on. - AH is part of the IPsec protocol that authenticates the sender and prevents manipulation of the data (ensures the completeness of the data). In the IP packet, the data is inserted immediately after the header. In addition, the packets include hash values, which are calculated using an equation from the communicated contents, secret key, and so on, in order to prevent the falsification of the sender and manipulation of the data. Unlike ESP, the communicated contents are not encrypted, and the data is sent and received as plain text. <hr/> <ul style="list-style-type: none"> • Encryption (Not available for the AH option.) Select DES, 3DES, AES-CBC 128, or AES-CBC 256. • Hash Select None, MD5, SHA1, SHA256, SHA384, or SHA512. None can be selected only when ESP is selected in Protocol. • SA Lifetime Specify the IKE SA lifetime. Type the time (seconds) and number of kilobytes (KByte). • Encapsulation Mode Select Transport or Tunnel. • Remote Router IP-Address Type the IP address (IPv4 or IPv6) of the remote router. Enter this information only when the Tunnel mode is selected. <hr/> <ul style="list-style-type: none">  <p>SA (Security Association) is an encrypted communication method using IPsec or IPv6 that exchanges and shares information, such as the encryption method and encryption key, in order to establish a secure communication channel before communication begins. SA may also refer to a virtual encrypted communication channel that has been established. The SA used for IPsec establishes the encryption method, exchanges the keys, and carries out mutual authentication according to the IKE (Internet Key Exchange) standard procedure. In addition, the SA is updated periodically.</p>

 **Related Information**

- [Configure an IPsec Template Using Web Based Management](#)

Use IEEE 802.1x Authentication for a Wired or a Wireless Network

- [What Is IEEE 802.1x Authentication?](#)
- [Configure IEEE 802.1x Authentication for a Wired or Wireless Network Using Web Based Management \(Web Browser\)](#)
- [IEEE 802.1x Authentication Methods](#)

What Is IEEE 802.1x Authentication?

IEEE 802.1x is an IEEE standard that limits access from unauthorised network devices. Your Brother machine sends an authentication request to a RADIUS server (Authentication server) through your access point or hub. After your request has been verified by the RADIUS server, your machine can access the network.



Related Information

- [Use IEEE 802.1x Authentication for a Wired or a Wireless Network](#)
-

Configure IEEE 802.1x Authentication for a Wired or Wireless Network Using Web Based Management (Web Browser)

- If you configure your machine using EAP-TLS authentication, you must install the client certificate issued by a CA before you start configuration. Contact your network administrator about the client certificate. If you have installed more than one certificate, we recommend writing down the certificate name you want to use.
- Before you verify the server certificate, you must import the CA certificate issued by the CA that signed the server certificate. Contact your network administrator or your Internet Service Provider (ISP) to confirm whether a CA certificate import is necessary.



You can also configure IEEE 802.1x authentication using the Wireless Setup Wizard from the control panel (Wireless network).

1. Start your web browser.
2. Type "https://machine's IP address" in your browser's address bar (where "machine's IP address" is your machine's IP address).

For example:

https://192.168.1.2



- If you are using a Domain Name System or enable a NetBIOS name, you can type another name, such as "SharedPrinter" instead of the IP address.

For example: https://SharedPrinter

- If you enable a NetBIOS name, you can also use the node name.

For example: https://brn123456abcdef

- The NetBIOS name can be found in the Network Configuration Report.

3. If required, type the password in the **Login** field, and then click **Login**.



The default password to manage this machine's settings is located on the back of the machine and marked "Pwd".

4. Go to the navigation menu, and then click **Network**.



Start from ☰, if the navigation menu is not shown on the left side of the screen.

5. Do one of the following:
 - For the wired network
Click **Wired** > **Wired 802.1x Authentication**.
 - For the wireless network
Click **Wireless** > **Wireless (Enterprise)**.
6. Configure the IEEE 802.1x authentication settings.



- To enable IEEE 802.1x authentication for wired networks, select **Enabled** for **Wired 802.1x status** on the **Wired 802.1x Authentication** page.
- If you are using **EAP-TLS** authentication, you must select the client certificate installed (shown with certificate name) for verification from the **Client Certificate** drop-down list.
- If you select **EAP-FAST**, **PEAP**, **EAP-TTLS**, or **EAP-TLS** authentication, select the verification method from the **Server Certificate Verification** drop-down list. Verify the server certificate using the CA certificate, imported to the machine in advance, issued by the CA that signed the server certificate.

Select one of the following verification methods from the **Server Certificate Verification** drop-down list:

Option	Description
No Verification	The server certificate can always be trusted. The verification is not performed.
CA Cert.	The verification method to check the CA reliability of the server certificate, using the CA certificate issued by the CA that signed the server certificate.
CA Cert. + ServerID	The verification method to check the common name ¹ value of the server certificate, in addition to the CA reliability of the server certificate.

7. When finished with configuration, click **Submit**.

For wired networks: After configuring, connect your machine to the IEEE 802.1x supported network. After a few minutes, print the Network Configuration Report to check the **<Wired IEEE 802.1x>** status.

Option	Description
Success	The wired IEEE 802.1x function is enabled and the authentication was successful.
Failed	The wired IEEE 802.1x function is enabled; however, the authentication failed.
Off	The wired IEEE 802.1x function is not available.

Related Information

- [Use IEEE 802.1x Authentication for a Wired or a Wireless Network](#)

Related Topics:

- [Configure Certificates for Device Security](#)
-

¹ The common name verification compares the common name of the server certificate to the character string configured for the **Server ID**. Before you use this method, contact your system administrator about the server certificate's common name and then configure **Server ID**.

IEEE 802.1x Authentication Methods

EAP-FAST

Extensible Authentication Protocol-Flexible Authentication via Secured Tunneling (EAP-FAST) has been developed by Cisco Systems, Inc., which uses a user ID and password for authentication, and symmetric key algorithms to achieve a tunnelled authentication process.

Your Brother machine supports the following inner authentication methods:

- EAP-FAST/NONE
- EAP-FAST/MS-CHAPv2
- EAP-FAST/GTC

EAP-MD5 (Wired network)

Extensible Authentication Protocol-Message Digest Algorithm 5 (EAP-MD5) uses a user ID and password for challenge-response authentication.

PEAP

Protected Extensible Authentication Protocol (PEAP) is a version of EAP method developed by Cisco Systems, Inc., Microsoft Corporation and RSA Security. PEAP creates an encrypted Secure Sockets Layer (SSL)/Transport Layer Security (TLS) tunnel between a client and an authentication server, for sending a user ID and password. PEAP provides mutual authentication between the server and the client.

Your Brother machine supports the following inner authentications:

- PEAP/MS-CHAPv2
- PEAP/GTC

EAP-TTLS

Extensible Authentication Protocol-Tunneled Transport Layer Security (EAP-TTLS) has been developed by Funk Software and Certicom. EAP-TTLS creates a similar encrypted SSL tunnel to PEAP, between a client and an authentication server, for sending a user ID and password. EAP-TTLS provides mutual authentication between the server and the client.

Your Brother machine supports the following inner authentications:

- EAP-TTLS/CHAP
- EAP-TTLS/MS-CHAP
- EAP-TTLS/MS-CHAPv2
- EAP-TTLS/PAP

EAP-TLS

Extensible Authentication Protocol-Transport Layer Security (EAP-TLS) requires digital certificate authentication both at a client and an authentication server.



Related Information

- [Use IEEE 802.1x Authentication for a Wired or a Wireless Network](#)

Use Active Directory Authentication

- [Introduction to Active Directory Authentication](#)
- [Configure Active Directory Authentication Using Web Based Management](#)
- [Log On to Change the Machine Settings Using the Machine's Control Panel \(Active Directory Authentication\)](#)

Introduction to Active Directory Authentication

Active Directory Authentication restricts the use of your machine. If Active Directory Authentication is enabled, the machine's control panel will be locked. You cannot change the machine's settings until you enter a User ID and password.

Active Directory Authentication offers the following features:

- Stores incoming print data
- Stores incoming fax data
- (DCP-L5518DN/MFC-L5718DN/MFC-L5728DW) Obtains the email address from the Active Directory server based on your User ID, when sending scanned data to an email server.

To use this feature, select the **On** option for the **Get Mail Address** setting and **LDAP + kerberos** authentication method. Your email address will be set as the sender when the machine sends scanned data to an email server, or as the recipient if you want to send the scanned data to your email address.

When Active Directory Authentication is enabled, your machine stores all incoming fax data. After you log on, the machine prints the stored fax data.

You can change the Active Directory Authentication settings using Web Based Management.



Related Information

- [Use Active Directory Authentication](#)

Configure Active Directory Authentication Using Web Based Management

Active Directory authentication supports Kerberos authentication and NTLMv2 authentication. You must configure the SNTP protocol (network time server) and DNS server configuration for authentication.

1. Start your web browser.
2. Type "https://machine's IP address" in your browser's address bar (where "machine's IP address" is your machine's IP address).
For example:
https://192.168.1.2
3. If required, type the password in the **Login** field, and then click **Login**.



The default password to manage this machine's settings is located on the back of the machine and marked "Pwd".

4. Go to the navigation menu, and then click **Administrator > User Restriction Function** or **Restriction Management**.



Start from , if the navigation menu is not shown on the left side of the screen.

5. Select **Active Directory Authentication**.
6. Click **Submit**.
7. Click **Active Directory Authentication**.
8. Configure the following settings:

Option	Description
Storage Fax RX Data	Select this option to store incoming fax data. You can print all incoming fax data after you log on to the machine.
Remember User ID	Select this option to save your User ID.
Active Directory Server Address	Type the IP address or the server name (for example: ad.example.com) of the Active Directory Server.
Active Directory Domain Name	Type the Active Directory domain name.
Protocol & Authentication Method	Select the protocol and authentication method.
SSL/TLS	Select the SSL/TLS option.
LDAP Server Port	Type the port number to connect the Active Directory server via LDAP (available only for LDAP + kerberos or LDAP + NTLMv2 authentication method).
LDAP Search Root	Type the LDAP search root (available only for LDAP + kerberos or LDAP + NTLMv2 authentication method).
Get Mail Address	Select this option to obtain logged on user's email address from the Active Directory server (available only for LDAP + kerberos or LDAP + NTLMv2 authentication method).

Option	Description
Get User's Home Directory	Select this option to obtain your home directory as the Scan to Network destination (available only for LDAP + kerberos or LDAP + NTLMv2 authentication method).

9. Click **Submit**.

Related Information

- [Use Active Directory Authentication](#)
-

Log On to Change the Machine Settings Using the Machine's Control Panel (Active Directory Authentication)

When Active Directory Authentication is enabled, the machine's control panel will be locked until you enter your User ID and password on the machine's control panel.

1. On the machine's control panel, enter your User ID.
2. Press [OK].
3. Enter your password.
4. Press [OK].
5. Press [OK] again.
6. When authentication is successful, the machine's control panel unlocks, and the LCD displays the Home screen.



Related Information

- [Use Active Directory Authentication](#)

Use LDAP Authentication

- [Introduction to LDAP Authentication](#)
- [Configure LDAP Authentication Using Web Based Management](#)
- [Log On to Change the Machine Settings Using the Machine's Control Panel \(LDAP Authentication\)](#)

Introduction to LDAP Authentication

LDAP Authentication restricts the use of your machine. If LDAP Authentication is enabled, the machine's control panel will be locked. You cannot change the machine's settings until you enter a User ID and password.

LDAP Authentication offers the following features:

- Stores incoming print data
- Stores incoming fax data
- Obtains the email address from the LDAP server based on your User ID, when sending scanned data to an email server.

To use this feature, select the **On** option for the **Get Mail Address** setting. Your email address will be set as the sender when the machine sends scanned data to an email server, or as the recipient if you want to send the scanned data to your email address.

When LDAP Authentication is enabled, your machine stores all incoming fax data. After you log on, the machine prints the stored fax data.

You can change the LDAP Authentication settings using Web Based Management.



Related Information

- [Use LDAP Authentication](#)

Configure LDAP Authentication Using Web Based Management

1. Start your web browser.
2. Type "https://machine's IP address" in your browser's address bar (where "machine's IP address" is your machine's IP address).

For example:

https://192.168.1.2

3. If required, type the password in the **Login** field, and then click **Login**.



The default password to manage this machine's settings is located on the back of the machine and marked "Pwd".

4. Go to the navigation menu, and then click **Administrator > User Restriction Function** or **Restriction Management**.



Start from ☰, if the navigation menu is not shown on the left side of the screen.

5. Select **LDAP Authentication**.
6. Click **Submit**.
7. Click the **LDAP Authentication** menu.
8. Configure the following settings:

Option	Description
Storage Fax RX Data	Select this option to store incoming fax data. You can print all incoming fax data after you log on to the machine.
Remember User ID	Select this option to save your User ID.
LDAP Server Address	Type the IP address or the server name (for example: ldap.example.com) of the LDAP server.
SSL/TLS	Select the SSL/TLS option to use LDAP over SSL/TLS.
LDAP Server Port	Type the LDAP server port number.
LDAP Search Root	Type the LDAP search root directory.
Attribute of Name (Search Key)	Type the attribute you want to use as a search key.
Get Mail Address	Select this option to obtain the logged user's email address from the LDAP server.
Get User's Home Directory	Select this option to obtain your home directory as the Scan to Network destination.

9. Click **Submit**.



Related Information

- [Use LDAP Authentication](#)

Log On to Change the Machine Settings Using the Machine's Control Panel (LDAP Authentication)

When LDAP Authentication is enabled, the machine's control panel will be locked until you enter your User ID and password on the machine's control panel.

1. On the machine's control panel, enter your User ID.
2. Press [OK].
3. Enter your password.
4. Press [OK].
5. Press [OK] again.
6. When authentication is successful, the machine's control panel unlocks, and the LCD displays the Home screen.



Related Information

- [Use LDAP Authentication](#)

Use Secure Function Lock 3.0

Secure Function Lock 3.0 increases security by restricting the functions available on your machine.

- [Before Using Secure Function Lock 3.0](#)
- [Configure Secure Function Lock 3.0 Using Web Based Management](#)
- [Scan Using Secure Function Lock 3.0](#)
- [Configure Public Mode for Secure Function Lock 3.0](#)
- [Additional Secure Function Lock 3.0 Features](#)

Before Using Secure Function Lock 3.0

Use Secure Function Lock to configure passwords, set specific user page limits, and grant access to some or all of the functions listed here.

You can configure and change the following Secure Function Lock 3.0 settings using Web Based Management:

- **Print**

Print includes print jobs sent via AirPrint, Brother iPrint&Scan, and Brother Mobile Connect.

If you register user login names in advance, the users do not need to enter their passwords when they use the print function.

- **Copy**

- **Scan**

Scan includes scan jobs sent via Brother iPrint&Scan and Brother Mobile Connect.

- **Send** (supported models only)

- **Receive** (supported models only)

- USB Direct Print (supported models only)

- Scan to USB (supported models only)

- **Page Limits**

- **Page Counters**



Touchscreen LCD models:

When Secure Function Lock is enabled, the machine automatically enters Public Mode and some of the machine's functions become restricted to authorised users only. To access the restricted machine functions, press , select your user name, and enter your password.



Related Information

- [Use Secure Function Lock 3.0](#)
-

Configure Secure Function Lock 3.0 Using Web Based Management

1. Start your web browser.
2. Type "https://machine's IP address" in your browser's address bar (where "machine's IP address" is your machine's IP address).

For example:

https://192.168.1.2

3. If required, type the password in the **Login** field, and then click **Login**.



The default password to manage this machine's settings is located on the back of the machine and marked "Pwd".

4. Go to the navigation menu, and then click **Administrator > User Restriction Function** or **Restriction Management**.



Start from ☰, if the navigation menu is not shown on the left side of the screen.

5. Select **Secure Function Lock**.
6. Click **Submit**.
7. Click the **Restricted Functions** menu.
8. In the **User List / Restricted Functions** field, type a group name or user name.
9. In the **Print** and the other columns, select a checkbox to allow, or clear a checkbox to restrict, the function listed.
10. To configure the maximum page count, select the **On** checkbox in the **Page Limits** column, and then type the maximum number in the **Max. Pages** field.
11. Click **Submit**.
12. Click the **User List** menu.
13. In the **User List** field, type the user name.
14. In the **Password** field, type a password.



The number of characters you can set differs depending on your model.

15. (DCP-L5518DN/MFC-L5718DN/MFC-L5728DW) In the **E-mail Address** field, type the user's email address .
16. To register the user's Card ID, type the card number in the **Card ID (NFC ID)** field .
17. Select **User List / Restricted Functions** from the drop-down list for each user.
18. Click **Submit**.



You can also change the user list lockout settings in the **Secure Function Lock** menu.



Related Information

- [Use Secure Function Lock 3.0](#)

Scan Using Secure Function Lock 3.0

Setting Scan restrictions (for administrators)

Secure Function Lock 3.0 allows an administrator to restrict which users are allowed to scan. When the Scan feature is set to Off for the public user setting, only users who have the **Scan** check box selected will be able to scan.

Using the Scan feature (for restricted users)

- To scan using the machine's control panel:
Restricted users must enter their passwords on the machine's control panel to access Scan mode.
- To scan from a computer:
Restricted users must enter their passwords on the machine's control panel before scanning from their computers. If the password is not entered on the machine's control panel, an error message will appear on the user's computer.



Related Information

- [Use Secure Function Lock 3.0](#)

Configure Public Mode for Secure Function Lock 3.0

Use the Secure Function Lock screen to set up Public Mode, which limits the functions available to public users. Public users will not need to enter a password to access the features made available through Public Mode settings.



Public Mode includes print jobs sent via Brother iPrint&Scan and Brother Mobile Connect.

1. Start your web browser.
2. Type "https://machine's IP address" in your browser's address bar (where "machine's IP address" is your machine's IP address).

For example:

https://192.168.1.2

3. If required, type the password in the **Login** field, and then click **Login**.



The default password to manage this machine's settings is located on the back of the machine and marked "Pwd".

4. Go to the navigation menu, and then click **Administrator > User Restriction Function** or **Restriction Management**.



Start from , if the navigation menu is not shown on the left side of the screen.

5. Select **Secure Function Lock**.
6. Click **Submit**.
7. Click the **Restricted Functions** menu.
8. In the **Public Mode** row, select a check box to allow, or clear a check box to restrict, the function listed.
9. Click **Submit**.



Related Information

- [Use Secure Function Lock 3.0](#)

Additional Secure Function Lock 3.0 Features

Configure the following features in the Secure Function Lock screen:

All Counter Reset

Click **All Counter Reset**, in the **Page Counters** column, to reset the page counter.

Export to CSV file

Click **Export to CSV file**, to export the current and last page counter including **User List / Restricted Functions** information as a CSV file.

Last Counter Record

Click **Last Counter Record** if you want the machine to retain the page count after the counter has been reset.



Related Information

- [Use Secure Function Lock 3.0](#)

Send or Receive an Email Securely

- [Configure Email Sending or Receiving Using Web Based Management](#)
- [Send an Email with User Authentication](#)
- [Send or Receive an Email Securely Using SSL/TLS](#)

Configure Email Sending or Receiving Using Web Based Management

We recommend using Web Based Management to configure secured email sending with user authentication, or email sending and receiving using SSL/TLS.

1. Start your web browser.
2. Type "https://machine's IP address" in your browser's address bar (where "machine's IP address" is your machine's IP address).
For example:
https://192.168.1.2
3. If required, type the password in the **Login** field, and then click **Login**.



The default password to manage this machine's settings is located on the back of the machine and marked "Pwd".

4. Go to the navigation menu, and then click **Network > Network > Protocol**.



Start from , if the navigation menu is not shown on the left side of the screen.

5. In the **POP3/IMAP4/SMTP Client** field, click **Advanced Setting** and make sure the status of **POP3/IMAP4/SMTP Client** is **Enabled**.
6. Configure the **POP3/IMAP4/SMTP Client** settings.
 - Confirm that the email settings are correct after configuration by sending a test email.
 - If you do not know the POP3/IMAP4/SMTP server settings, contact your network administrator or Internet Service Provider (ISP).
7. When finished, click **Submit**.
The **Test Send/Receive E-mail Configuration** dialog box appears.
8. Follow the instructions in the dialog box to test the current settings.



Related Information

- [Send or Receive an Email Securely](#)

Send an Email with User Authentication

Your machine supports the SMTP-AUTH method to send email via an email server that requires user authentication. This method prevents unauthorised users from accessing the email server.

You can use the SMTP-AUTH method for email notification, email reports and I-Fax.



We recommend using Web Based Management to configure the SMTP authentication.

Email Server Settings

You must configure your machine's SMTP authentication method to match the method used by your email server. For details about your email server settings, contact your network administrator or Internet Service Provider (ISP).



To enable SMTP server authentication: in the Web Based Management **POP3/IMAP4/SMTP Client** screen, under **Server Authentication Method**, you must select **SMTP-AUTH**.



Related Information

- [Send or Receive an Email Securely](#)
-

Send or Receive an Email Securely Using SSL/TLS

Your machine supports SSL/TLS communication methods. To use an email server that is using SSL/TLS communication, you must configure the following settings.



We recommend using Web Based Management to configure SSL/TLS.

Verify Server Certificate

Under **SSL/TLS**, if you choose **SSL** or **TLS**, the **Verify Server Certificate** check box will be selected automatically.



- Before you verify the server certificate, you must import the CA certificate issued by the CA that signed the server certificate. Contact your network administrator or your Internet Service Provider (ISP) to confirm if importing a CA certificate is necessary.
- If you do not need to verify the server certificate, clear the **Verify Server Certificate** check box.

Port Number

If you select **SSL**, or **TLS**, the **Port** value will be changed to match the protocol. To change the port number manually, type the port number after you select **SSL/TLS** settings.

You must configure your machine's communication method to match the method used by your email server. For details about your email server settings, contact your network administrator or your ISP.

In most cases, the secured webmail services require the following settings:

SMTP	Port	25
	Server Authentication Method	SMTP-AUTH
	SSL/TLS	TLS
POP3	Port	995
	SSL/TLS	SSL
IMAP4	Port	993
	SSL/TLS	SSL



Related Information

- [Send or Receive an Email Securely](#)

Related Topics:

- [Configure Certificates for Device Security](#)

Store Print Log to Network

- [Store Print Log to Network Overview](#)
- [Configure the Store Print Log to Network Settings Using Web Based Management](#)
- [Use the Store Print Log to Network's Error Detection Setting](#)
- [Use Store Print Log to Network with Secure Function Lock 3.0](#)

Store Print Log to Network Overview

The Store Print Log to Network feature allows you to save the print log file from your machine to a network server using the Common Internet File System (CIFS) protocol. You can record the ID, type of print job, job name, user name, date, time and the number of printed pages for every print job. CIFS is a protocol that runs over TCP/IP, allowing computers on a network to share files over an intranet or the Internet.

The following print functions are recorded in the print log:

- Print jobs from your computer
- USB Direct Print (supported models only)
- Copy
- Received Fax (supported models only)



- The Store Print Log to Network feature supports Kerberos authentication and NTLMv2 authentication. You must configure the SNTP protocol (network time server), or you must set the date, time and time zone correctly on the control panel for authentication.
- You can set the file type to TXT or CSV when storing a file to the server.



Related Information



- [Store Print Log to Network](#)

Configure the Store Print Log to Network Settings Using Web Based Management



1. Start your web browser.
2. Type "https://machine's IP address" in your browser's address bar (where "machine's IP address" is your machine's IP address).
For example:
https://192.168.1.2
3. If required, type the password in the **Login** field, and then click **Login**.

 The default password to manage this machine's settings is located on the back of the machine and marked "Pwd".

4. Go to the navigation menu, and then click **Administrator > Store Print Log to Network**.

 Start from , if the navigation menu is not shown on the left side of the screen.

5. In the **Print Log** field, click **On**.
6. Configure the following settings:

Option	Description
Network Folder Path	Type the destination folder where your print log will be stored on the CIFS server (for example: \\ComputerName\SharedFolder).
File Name	Type the file name you want to use for the print log (up to 32 characters).
File Type	Select the TXT or CSV option for the print log file type.
Time Source for Log	Select the time source for the print log.
Auth. Method	Select the authentication method required for access to the CIFS server: Auto , Kerberos , or NTLMv2 . Kerberos is an authentication protocol which allows devices or individuals to securely prove their identity to network servers using a single sign-on. NTLMv2 is the authentication method used by Windows to log into servers. <ul style="list-style-type: none">• Auto: If you select Auto, NTLMv2 will be used to the authentication method.• Kerberos: Select the Kerberos option to use Kerberos authentication only.• NTLMv2: Select the NTLMv2 option to use NTLMv2 authentication only. <p> For the Kerberos and NTLMv2 authentication, you must also configure the Date&Time settings or the SNTP protocol (network time server) and DNS server.</p> <p>You can also configure the Date & Time settings from the machine's control panel.</p>
Username	Type the user name for the authentication (up to 96 characters). <p> If the user name is part of a domain, enter the user name in one of the following styles: user@domain or domain\user.</p>
Password	Type the password for the authentication (up to 32 characters).

Option	Description
Kerberos Server Address (if needed)	Type the Key Distribution Center (KDC) host address (for example: kerberos.example.com; up to 64 characters) or the IP address (for example: 192.168.56.189).
Error Detection Setting	Choose what action should be taken when the print log cannot be stored to the server due to a network error.

7. In the **Connection Status** field, confirm the last log status.



You can also confirm the error status on the LCD of your machine.

8. Click **Submit** to display the **Test Print Log to Network** page.

To test your settings, click **Yes** and then go to the next step.

To skip the test, click **No**. Your settings will be submitted automatically.

9. The machine will test your settings.

10. If your settings are accepted, **Test OK** appears on the screen.

If **Test Error** appears, check all settings, and then click **Submit** to display the Test page again.



Related Information

- [Store Print Log to Network](#)
-

Use the Store Print Log to Network's Error Detection Setting

Use Error Detection Settings to determine the action that is taken when the print log cannot be stored to the server due to a network error.

1. Start your web browser.
2. Type "https://machine's IP address" in your browser's address bar (where "machine's IP address" is your machine's IP address).

For example:

https://192.168.1.2

3. If required, type the password in the **Login** field, and then click **Login**.



The default password to manage this machine's settings is located on the back of the machine and marked "Pwd".

4. Go to the navigation menu, and then click **Administrator > Store Print Log to Network**.



Start from , if the navigation menu is not shown on the left side of the screen.

5. In the **Error Detection Setting** section, select the **Cancel Print** or **Ignore Log & Print** option.

Option	Description
Cancel Print	<p>If you select the Cancel Print option, the print jobs are cancelled when the print log cannot be stored to the server.</p> <p> Even if you select the Cancel Print option, your machine will print a received fax. (For MFC models)</p>
Ignore Log & Print	<p>If you select the Ignore Log & Print option, the machine prints the documentation even if the print log cannot be stored to the server.</p> <p>When the Store Print Log function has recovered, the print log is recorded as follows:</p> <pre>Id, Type, Job Name, User Name, Date, Time, Print Pages 1, Print(xxxxxxx), "Document01.doc", "user01", 03/03/20xx, 14:01:32, 52 2, Print(xxxxxxx), "Document02.doc", "user01", 03/03/20xx, 14:45:30, ? 3, <ERROR>, ?, ?, ?, ?, ? 4, Print(xxxxxxx), "Report01.xls", "user02", 03/03/20xx, 19:30:40, 4</pre> <p>a. If the print log cannot be stored at the end of printing, the number of printed pages will not be recorded.</p> <p>b. If the print log cannot be stored at the beginning and the end of printing, the print log of the job will not be recorded. When the function has recovered, the error is reflected in the print log.</p>

6. Click **Submit** to display the **Test Print Log to Network** page.
To test your settings, click **Yes** and then go to the next step.
To skip the test, click **No**. Your settings will be submitted automatically.
7. The machine will test your settings.
8. If your settings are accepted, **Test OK** appears on the screen.
If **Test Error** appears, check all settings, and then click **Submit** to display the Test page again.



Related Information

- [Store Print Log to Network](#)

Use Store Print Log to Network with Secure Function Lock 3.0

When Secure Function Lock 3.0 is active, the names of the registered users for copy, Fax RX and USB Direct Print (if available) are recorded in the Store Print Log to Network report. When the Active Directory Authentication is enabled, the user name is recorded in the Store Print Log to Network report:

```
Id, Type, Job Name, User Name, Date, Time, Print Pages
1, Copy, -, -, 04/04/20xx, 09:05:12, 3
2, Fax, -, -, 04/04/20xx, 09:45:30, 5
3, Copy, -, "BOB", 04/04/20xx, 10:20:30, 4
4, Fax, -, "BOB", 04/04/20xx, 10:35:12, 3
5, USB Direct, -, "JOHN", 04/04/20xx, 11:15:43, 6
```



Related Information

- [Store Print Log to Network](#)

Lock the Machine Settings from the Control Panel

Before turning the machine's Setting Lock on, write down and save your password. If you forget the password, you must reset all passwords stored in the machine by contacting your administrator or Brother customer service.

- [Setting Lock Overview](#)



Setting Lock Overview

Use the Setting Lock feature to block unauthorised access to machine settings.

When Setting Lock is set to On, you cannot access the machine settings without entering the password.

- [Set the Setting Lock Password](#)
- [Change the Setting Lock Password](#)
- [Turn Setting Lock On](#)

Set the Setting Lock Password

1. Press  [Settings] > [All Settings] > [General Setup] > [Setting Lock].
2. Enter a four-digit number for the password.
3. Press [OK].
4. When the LCD displays [Verify:], re-enter the password.
5. Press [OK].
6. Press .





Related Information

- [Setting Lock Overview](#)

Related Topics:

- [How to Enter Text on Your Machine](#)

Change the Setting Lock Password

1. Press  [Settings] > [All Settings] > [General Setup] > [Setting Lock] > [Set Password].
2. Enter the current four-digit password.
3. Press [OK].
4. Enter a new four-digit password.
5. Press [OK].
6. When the LCD displays [Verify:], re-enter the password.
7. Press [OK].
8. Press .



Related Information

- [Setting Lock Overview](#)

Turn Setting Lock On

1. Press  [Settings] > [All Settings] > [General Setup] > [Setting Lock] > [Lock Off⇒On].
2. Enter the current four-digit password.
3. Press [OK].



To turn Setting Lock off, press  on the LCD, enter the current four-digit password, and then press [OK].



Related Information

- [Setting Lock Overview](#)



Use Global Network Detection Features

When you use your machine on a private network, use the Global Network Detection feature to avoid a risk from unexpected attacks from the global network.

- [Enable Global IP Address Detection](#)
- [Block Communications from the Global Network](#)

Enable Global IP Address Detection

Use this feature to check your machine's IP address. When your machine is assigned to a global IP address, an alert is displayed on the machine.

1. Press  [Settings] > [All Settings] > [Network] > [Global Detect] > [Allow Detect] > [On].
2. Press .





Related Information

- [Use Global Network Detection Features](#)
-

Block Communications from the Global Network



When you enable this feature, it limits receiving jobs from devices with global IP addresses

1. Press  [Settings] > [All Settings] > [Network] > [Global Detect] > [Reject Access] > [On].
2. Press .



Related Information

- [Use Global Network Detection Features](#)

Administrator

- [Network Features](#)
- [Security Features](#)
- [Brother Management Tools](#)

Network Features

- [Change Machine Settings Using Web Based Management](#)
- [Print the Network Configuration Report](#)
- [Synchronise Time with the SNTP Server Using Web Based Management](#)
- [Store Print Log to Network](#)

Security Features

Your machine uses some of the latest network security and encryption protocols. These network features can be integrated into your overall network security plan to help protect your data and prevent unauthorised access to the machine.

- [Network Security](#)
- [User Authentication](#)

Network Security

- [Before Using Network Security Features](#)
- [Configure Certificates for Device Security](#)
- [Use SSL/TLS](#)
- [Use SNMPv3](#)
- [Use IPsec](#)
- [Use IEEE 802.1x Authentication for a Wired or a Wireless Network](#)

Before Using Network Security Features

Your machine employs some of the latest network security and encryption protocols available today. These network features can be integrated into your overall network security plan to help protect your data and prevent unauthorised access to the machine.



We recommend disabling the Telnet, FTP server, and TFTP protocols. Accessing the machine using these protocols is not secure.



Related Information

- [Security](#)
- [Network Security](#)
 - [Disable Unnecessary Protocols](#)

User Authentication

- [Use Active Directory Authentication](#)
- [Use LDAP Authentication](#)
- [Use Secure Function Lock 3.0](#)

Brother Management Tools

Use one of Brother's management tools to configure your Brother machine's network settings.
Go to your model's **Downloads** page at support.brother.com to download the tools.



Related Information

- [Administrator](#)
-

Mobile Connect

- [AirPrint](#)
- [Mopria™ Print Service and Mopria™ Scan](#)
- [Brother Mobile Connect](#)
- [WeChat Print](#)

AirPrint

- [AirPrint Overview](#)
- [Before Using AirPrint \(macOS\)](#)
- [Print Using AirPrint](#)
- [Scan Using AirPrint \(macOS\)](#)
- [Send a Fax Using AirPrint \(macOS\)](#)

AirPrint Overview

AirPrint is a printing solution for Apple operating systems that allows you to wirelessly print photos, email, web pages, and documents from your iPad, iPhone, iPod touch, and Mac computer without the need to install a driver.

AirPrint also lets you send faxes directly from your Mac computer without printing them and lets you scan documents to your Mac computer. (MFC-L5718DN/MFC-L5728DW)

AirPrint also lets you scan documents to your Mac computer.

For more information, visit Apple's website.

Use of the Works with Apple badge means that an accessory has been designed to work specifically with the technology identified in the badge and has been certified by the developer to meet Apple performance standards.



✓ Related Information

- [AirPrint](#)

Related Topics:

- [AirPrint Problems](#)

Before Using AirPrint (macOS)

Before printing using macOS, add your machine to the printer list on your Mac computer.

1. Select **System Preferences** from the Apple menu.
2. Click **Printers & Scanners**.
3. Click the + icon below the Printers pane on the left.
The **Add Printer** screen appears.
4. Do one of the following:
 - macOS v12
Select your machine, and then select your model's name from the **Use** pop-up menu.
 - macOS v11
Select your machine, and then select **AirPrint** from the **Use** pop-up menu.
5. Click **Add Printer**.



Related Information



- [AirPrint](#)

Print Using AirPrint

- [Print from iPad, iPhone, or iPod touch](#)
- [Print Using AirPrint \(macOS\)](#)

Print from iPad, iPhone, or iPod touch

The procedure used to print may vary by application. Safari is used in the example below.

1. Make sure your machine is turned on.
2. Load the paper in the paper tray and change the paper tray settings on your machine.
3. Use Safari to open the page that you want to print.
4. Tap  or .
5. Tap **Print**.
6. Make sure your machine is selected.
7. If a different machine (or no machine) is selected, tap **Printer**.
A list of available machines appears.
8. Tap your machine's name in the list.
9. Select the options you want, such as the number of pages to print and 2-sided printing (if supported by your machine).
10. Tap **Print**.



Related Information

- [Print Using AirPrint](#)

Print Using AirPrint (macOS)

The procedure used to print may vary by application. Safari is used in the example below. Before printing, make sure your machine is in the printer list on your Mac computer.

1. Make sure your machine is turned on.
2. Load the paper in the paper tray and change the paper tray settings on your machine.
3. On your Mac computer, use Safari to open the page that you want to print.
4. Click the **File** menu, and then select **Print**.
5. Make sure your machine is selected. If a different machine (or no machine) is selected, click the **Printer** pop-up menu, and then select your machine.
6. Select the desired options, such as the number of pages to print and 2-sided printing (if supported by your machine).
7. Click **Print**.



Related Information

- [Print Using AirPrint](#)

Related Topics:

- [Before Using AirPrint \(macOS\)](#)

Scan Using AirPrint (macOS)

Before scanning, make sure your machine is in the scanner list on your Mac computer.

1. Load your document.
2. Select **System Preferences** from the Apple menu.
3. Click **Printers & Scanners**.
4. Select your machine from the scanner list.
5. Click the **Scan** tab, and then click the **Open Scanner...** button.
The Scanner screen appears.
6. If you place the document in the ADF, select **Use Document Feeder** check box, and then select the size of your document from the scan size setting pop-up menu.
7. Select the destination folder or destination application from the destination setting pop-up menu.
8. Click **Show Details** to change the scanning settings if needed.
You can crop the image manually by dragging the mouse pointer over the portion you want to scan when scanning from the scanner glass.
9. Click **Scan**.



Related Information

- [AirPrint](#)

Related Topics:

- [Before Using AirPrint \(macOS\)](#)

Send a Fax Using AirPrint (macOS)

Related Models: MFC-L5718DN/MFC-L5728DW

Make sure your machine is in the printer list on your Mac computer. Apple TextEdit is used in the example below.



AirPrint supports only monochrome fax documents.

1. Make sure your machine is turned on.
2. On your Mac computer, open the file that you want to send as a fax.
3. Click the **File** menu, and then select **Print**.
4. Click the **Printer** pop-up menu, and then select your model with - **Fax** in the name.
5. Type the fax recipient information.
6. Click **Fax**.



Related Information

- [AirPrint](#)

Related Topics:

- [PC-FAX for Mac\(Sending only\)](#)
- [Before Using AirPrint \(macOS\)](#)

Mopria™ Print Service and Mopria™ Scan

Mopria™ Print Service is a print feature and Mopria™ Scan is a scan feature on Android™ mobile devices developed by the Mopria Alliance™. With this service, you can connect to the same network as your machine to print and scan without additional setup.

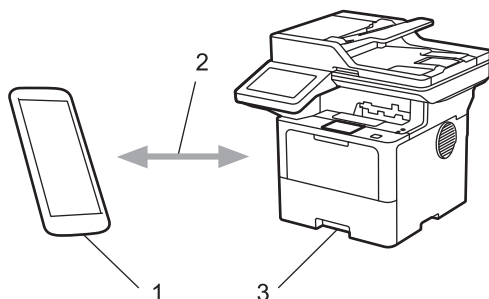

1. Android™ Mobile Device
2. Wi-Fi® Connection
3. Your Machine

The Mopria™ Print Service or Mopria™ Scan must be downloaded from a search engine and installed on your Android™ device. Before using these Mopria™ features, make sure you enable them on your mobile device.

Related Information

- [Mobile Connect](#)

Brother Mobile Connect

Use Brother Mobile Connect to print and scan from your mobile device.

- For Android™ devices:

Brother Mobile Connect allows you to use your Brother machine's features directly from your Android™ device.

Go to your model's **Downloads** page at support.brother.com to download Brother Mobile Connect.

- For all iOS or iPadOS supported devices including iPhone, iPad, and iPod touch:

Brother Mobile Connect allows you to use your Brother machine's features directly from your iOS or iPadOS device.

Download and install Brother Mobile Connect from the App Store.



Related Information

- [Mobile Connect](#)

Related Topics:

- [Brother iPrint&Scan](#)
- [Access Brother iPrint&Scan \(Windows/Mac\)](#)

WeChat Print

Your machine can print through an app for WeChat, which is called "兄弟畅享印". "兄弟畅享印" lets you wirelessly print photos and documents without installing a driver.

- Connect your machine before using WeChat print function for the first time. Go to www.brother.cn/minisite/bcactivity/FAQ.html for operation instructions.
- You need to install and set up Brother Mobile Connect on your mobile device. For more information, see *Related Information*.
- For network setups that use a proxy server, the machine must also be configured to use a proxy server. If you are unsure of your network configuration, check with your network administrator.

1. Start Brother Mobile Connect on your mobile device.
2. Tap **WeChat Print** on the Home screen.
3. Follow the on-screen instructions.
4. When the **Online Functions Settings** screen appears, tap the **Enable** button, and then follow the on-screen instructions.



You can also configure the settings from your machine. Press [Apps] > [Online Functions], and then follow the on-screen instructions.
If the End-User License Agreement (EULA) screen appears, follow the on-screen instructions.



Related Information

- [Mobile Connect](#)

Related Topics:

- [Configure the Proxy Server Settings Using Web Based Management](#)

Brother iPrint&Scan

- [Access Brother iPrint&Scan \(Windows/Mac\)](#)
- [Scan Using Brother iPrint&Scan \(Windows/Mac\)](#)

Access Brother iPrint&Scan (Windows/Mac)

Use Brother iPrint&Scan for Windows and Mac to print and scan from your computer.

The following screen shows an example of Brother iPrint&Scan for Windows. The actual screen may differ depending on the version of the application.

- For Windows
Go to your model's **Downloads** page at support.brother.com to download the latest application.
- For Mac
Download and install Brother iPrint&Scan from the App Store.

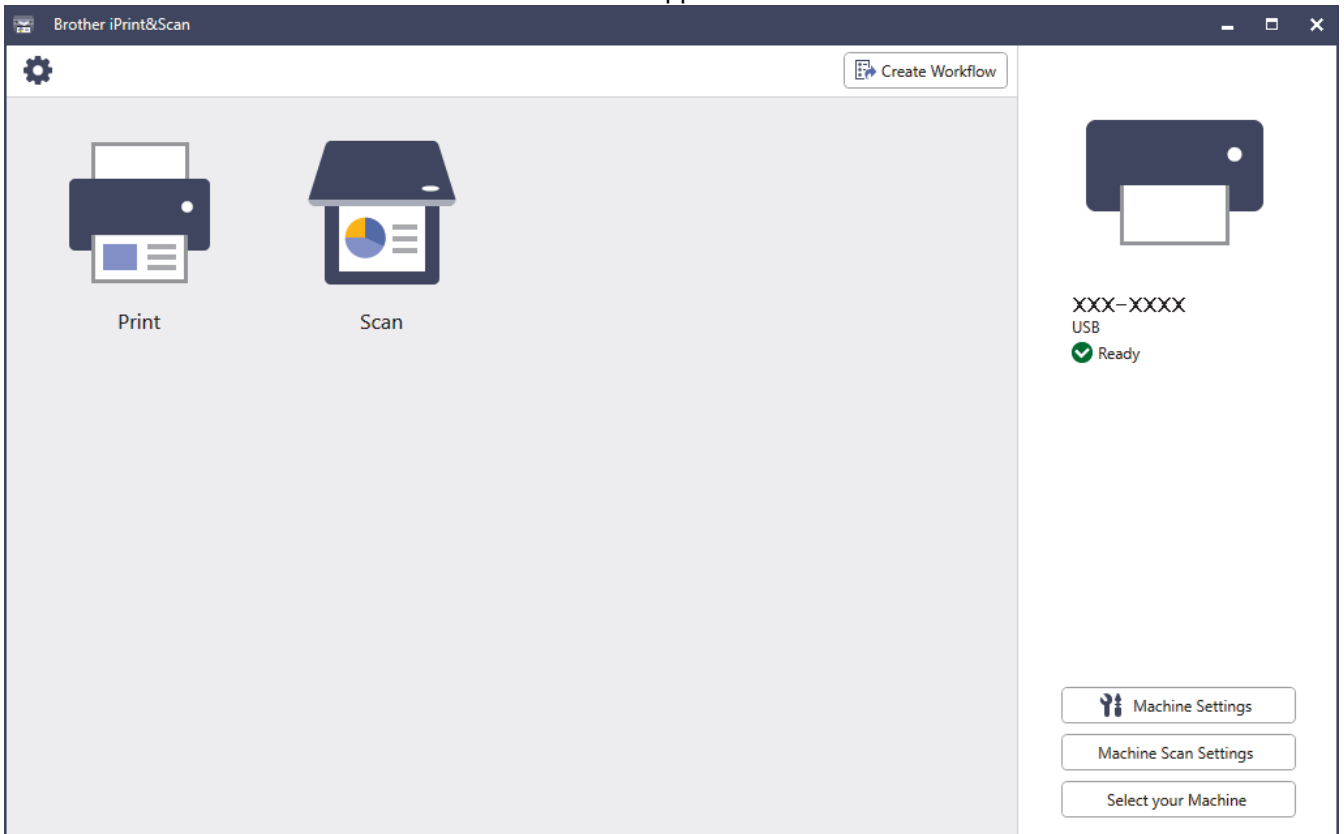

If prompted, install the driver and software necessary to use your machine. Download the installer from your model's **Downloads** page at support.brother.com.

✓ Related Information

- [Brother iPrint&Scan](#)

Related Topics:

- [Brother Mobile Connect](#)
- [Scan Using Brother iPrint&Scan \(Windows/Mac\)](#)

Troubleshooting

Use this section to resolve typical problems you may encounter when using your machine. You can correct most problems yourself.

IMPORTANT

For technical help, you must call Brother customer service or your local Brother dealer.



If you need additional help, visit support.brother.com.

First, check the following:

- The machine's power cord is connected correctly and the machine's power is on. See the *Quick Setup Guide*.
- All of the protective materials have been removed. See the *Quick Setup Guide*.
- Paper is loaded correctly in the paper tray.
- The interface cables are securely connected to the machine and the computer, or the wireless connection is set up on both the machine and your computer.
- Error and maintenance messages

If you did not solve the problem with the checks, identify the problem and then see *Related Information*.



Related Information



- [Error and Maintenance Messages](#)
- [Document Jams](#)
- [Paper Jams](#)
- [Printing Problems](#)
- [Improve the Print Quality](#)
- [Telephone and Fax Problems](#)
- [Network Problems](#)
- [AirPrint Problems](#)
- [Other Problems](#)
- [Check the Machine Information](#)
- [Reset Your Machine](#)



Error and Maintenance Messages

As with any sophisticated office product, errors may occur and supply items may have to be replaced. If this happens, your machine identifies the error or required routine maintenance and shows the appropriate message. The most common error and maintenance messages are shown in the table.





Follow the instructions in the **Action** column to solve the error and remove the message.

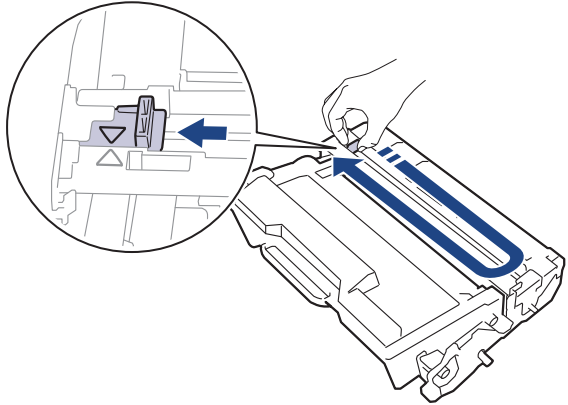

You can correct most errors and perform routine maintenance by yourself. If you need more tips: Visit support.brother.com, and click the **FAQs & Troubleshooting** page.

Error Message	Cause	Action
2-sided Disabled	The back cover of the machine is not closed completely.	Close the back cover of the machine until it locks in the closed position.
	The 2-sided tray is not installed completely.	Install the 2-sided tray firmly in the machine.
Access Denied	The function you want to use is restricted by Secure Function Lock 3.0.	Call your administrator to check your Secure Function Lock Settings.
Cannot Detect	Your machine cannot detect the drum unit.	Remove the toner cartridge and drum unit assembly. Remove the toner cartridge from the drum unit, and reinstall the toner cartridge back in the drum unit. Reinstall the toner cartridge and drum unit assembly back in the machine.
	Your machine cannot detect the toner cartridge.	
Cannot Print ##	The machine has a mechanical problem.	<ul style="list-style-type: none"> Press and hold  to turn the machine off, wait a few minutes, and then turn it on again. If the problem continues, contact Brother customer service or your local Brother dealer.
Cannot Scan	The document is too long for 2-sided scanning.	Press  . For 2-sided scanning, use A4 size paper. Other paper must be within the following size: Length: 147.3 to 355.6 mm Width: 105 to 215.9 mm
Cannot Scan ##	The machine has a mechanical problem.	<ul style="list-style-type: none"> Press and hold  to turn the machine off, and then turn it on again. If the problem continues, contact Brother customer service or your local Brother dealer.
Comm.Error	Poor telephone line quality caused a communication error.	Send the fax again or connect the machine to another telephone line. If the problem continues, contact your telephone company and ask them to check the telephone line.
Cooling Down	The temperature of the inside of the machine is too hot. The machine pauses its current print job and goes into Cooling Down mode.	Wait until the machine has finished cooling down. Make sure all vents on the machine are clear of obstructions. When the machine has cooled down, it will resume printing. If the fan is not spinning, disconnect the machine from the power for several minutes, then reconnect it.
Cover is Open	The front cover is not completely closed.	Open and then firmly close the front cover of the machine.

Error Message	Cause	Action
Cover is Open.	The fuser cover is not completely closed or paper was jammed in the back of the machine when you turned on the power.	Close the fuser cover located inside the back cover of the machine. Make sure paper is not jammed inside the back of the machine, and then close the fuser cover.
Cover is Open.	The ADF cover is not completely closed.	Close the ADF cover. If the error message remains, press  .
Disconnected	The other person or other person's fax machine stopped the call.	Try to send or receive again. If calls are stopped repeatedly and you are using a VoIP (Voice over IP) system, try changing the Compatibility to Basic (for VoIP).
Document Jam	The document was not inserted or fed correctly, or the document scanned from the ADF was too long.	Remove the jammed paper from the ADF unit. Clear any debris or scraps of paper from the ADF unit paper path. Press  .
Drum !	The corona wire on the drum unit must be cleaned.	Clean the corona wire on the drum unit.  <i>See Related Information: Clean the Corona Wire.</i> If the problem continues, replace the drum unit with a new one.
	The drum unit or the toner cartridge and drum unit assembly is not installed correctly.	Remove the drum unit, remove the toner cartridge from the drum unit, and put the toner cartridge back into the drum unit. Reinstall the drum unit in the machine.
Drum Error	The drum unit is not installed correctly.	Reinstall the toner cartridge and drum unit assembly. If the problem continues, replace the drum unit with a new one. <i>See Related Information: Replace the Drum Unit.</i>
Jam 2-sided	The paper is jammed in the 2-sided tray or inside the back cover.	Remove the 2-sided tray and open the back cover to pull out all jammed paper.
Jam Inside	The paper is jammed inside the machine.	Open the front cover, remove the toner cartridge and drum unit assembly, and pull out all jammed paper. Close the front cover.
Jam MP Tray	The paper is jammed in the MP tray.	Remove all jammed paper from in and around the MP tray. Press <i>Retry</i> .
Jam Rear	The paper is jammed in the back of the machine.	Open the fuser cover and remove all jammed paper. Close the fuser cover. If the error message remains, press <i>Retry</i> .

Error Message	Cause	Action
Jam Tray 1 Jam Tray 2 Jam Tray 3	The paper is jammed in the indicated paper tray.	Pull out the paper tray and remove all jammed paper as shown in the animation on the LCD.
Limit Exceeded	The print limit set in Secure Function Lock 3.0 was reached.	Contact your administrator to check your Secure Function Lock settings.
Media Type Mismatch	The media type specified in the printer driver differs from the paper type specified in the machine's menu.	Load the correct type of paper in the tray indicated on the LCD, and then select the correct media type in the Paper Type setting on the machine. Press Retry .
No Drum	The drum unit is not installed correctly.	Reinstall the toner cartridge and drum unit assembly. <i>See Related Information: Replace the Drum Unit.</i>
No HUB Support	A USB hub device is connected to the USB accessory port.	Disconnect the USB hub device from the USB accessory port.
No Paper	The machine is out of paper, or paper is not loaded correctly in the paper trays.	<ul style="list-style-type: none"> • Refill paper in the paper trays. Make sure the paper guides are set to the correct size. • If paper is in the tray, remove it and load it again. Make sure the paper guides are set to the correct size. • Do not overfill the paper tray.
No Paper Fed T1 No Paper Fed T2 No Paper Fed T3	The machine cannot feed paper from the indicated paper tray.	Pull out the paper tray indicated on the LCD and remove all jammed paper.
No Paper MP Tray	The MP tray is out of paper, or paper is not loaded correctly in the MP tray.	Do one of the following: <ul style="list-style-type: none"> • Refill paper in the MP tray. Make sure the paper guides are set to the correct size. • If paper is in the tray, remove it and load it again. Make sure the paper guides are set to the correct size.
No Paper No Paper T1 No Paper T2 No Paper T3 No Paper Tray 1 No Paper Tray 2 No Paper Tray 3	The machine cannot feed paper from the indicated paper tray.	Do one of the following: <ul style="list-style-type: none"> • Refill paper in the paper tray indicated on the LCD. Make sure the paper guides are set to the correct size. • If paper is in the tray, remove it and load it again. Make sure the paper guides are set to the correct size. • Do not overfill the paper tray.
No Response	An unsupported USB device has been connected to the USB accessory port.	<ul style="list-style-type: none"> • Unplug the device from the USB accessory port. • Press and hold  to turn the machine off, and then turn it on again.
No Response/Busy	The number you dialled does not answer or is busy.	Verify the number and try again.

Error Message	Cause	Action
No Toner	The toner cartridge is not installed or is not installed correctly.	Remove the toner cartridge and drum unit assembly. Remove the toner cartridge from the drum unit, and reinstall the toner cartridge back in the drum unit. Reinstall the toner cartridge and drum unit assembly back in the machine. If the problem continues, replace the toner cartridge with a new one. <i>See Related Information: Replace the Toner Cartridge.</i>
No Tray T1 No Tray T2 No Tray T3	The paper tray is not installed or not installed correctly.	Reinstall the paper tray indicated on the LCD.
Out of Fax Memory	The machine's fax memory is full.	If you are using the Fax Preview function, delete unwanted received fax data. If you are using the Memory Receive function and are not using the Fax Preview function, print received fax data. To print fax data, press  Settings > All Settings > Fax > Print Document.
Out of Memory	The machine's memory is full.	If a fax-sending or copy operation is in process Do one of the following: <ul style="list-style-type: none"> • Press Send Now to send the pages scanned so far. • Press Partial Print to copy the pages scanned so far. • Press Quit or  and wait until the other operations that are in progress finish, and then try again. If a scan operation is in progress, do one of the following: <ul style="list-style-type: none"> • Split the document into multiple parts. • Reduce the resolution. • Reduce the file size. • Select the high compression PDF file type. • Clear faxes from the memory. If a print operation is in process Press  and reduce the print resolution.
Output Tray Full	The output paper tray is full.	Remove the printed paper from the Face-down output tray.
Paper Low Paper Low T1 Paper Low T2 Paper Low T3	The paper tray is nearly empty.	Refill the paper in the paper tray indicated on the LCD.
Print Data Full	The machine's memory is full.	Press  and delete the previously stored secure print data.
Received Fax ##	An unprinted received fax is waiting to print on the correct size paper.	To print the received fax, load the correct size of paper in the tray indicated on the LCD. Paper sizes available for fax printing are A4, Letter, Legal, Folio, Mexico Legal and India Legal.

Error Message	Cause	Action
Replace Toner	The toner cartridge is at the end of its life. After stopping printing, faxes are stored in memory while memory is available.	Replace the toner cartridge with a new one. See <i>Related Information: Replace the Toner Cartridge</i> .
Self-Diagnostic	The fuser unit does not work correctly.	Press and hold  to turn the machine off, wait a few seconds, and then turn it on again. Leave the machine idle for 15 minutes with the power on.
	The fuser unit is too hot.	
Size Error	The paper tray you selected does not support the paper size specified in the printer driver.	Change the printer driver setting or machine's tray setting so that the paper size selected in the printer driver matches the paper size loaded in the tray you selected.
Size Error 2-sided	The paper size specified in the machine's paper size setting is not suitable for automatic 2-sided printing.	Press  (if required). Load the correct size of paper in the tray and set the tray for that paper size.
	The paper in the tray is not the correct size and is not suitable for automatic 2-sided printing.	Choose a paper size suitable for 2-sided printing. The paper size suitable for automatic 2-sided printing is A4.
Size Mismatch	The paper in the tray is not the correct size.	Load the correct size of paper in the tray indicated on the LCD and set the size of paper for the tray.
Storage device not recognized	Your machine cannot read from or write to the USB flash memory drive.	Press and hold  to turn the machine off, and then turn it on again. If the problem continues, reset the location where you save jobs.
Storage Full	The USB flash memory drive you are using does not have enough free space to store print data.	Delete the previously stored print data from the USB flash memory drive.
Supplies Drum End Soon	The drum unit is near the end of its life.	Order a new drum unit before the LCD displays <i>Replace Drum</i> .
Supplies Replace Drum	It is time to replace the drum unit.	Replace the drum unit with a new one. See <i>Related Information: Replace the Drum Unit</i> .
Supplies Toner Low	If the LCD displays this message, you can still print. The toner cartridge is near the end of its life.	Order a new toner cartridge now so you have it ready when the LCD displays <i>Replace Toner</i> .
Too Many Trays	The number of installed Optional Trays exceeds the maximum number.	Reduce the number of Optional Trays.
Touchscreen Initialisation Failed	The touchscreen was pressed when turning the machine on.	Make sure nothing is touching the touchscreen.
	Debris may be stuck between the lower part of the touchscreen and its frame.	Insert a piece of stiff paper between the lower part of the touchscreen and its frame and slide it back and forth to push out any debris.
Tray removed	The standard paper tray is not installed or not installed correctly.	Reinstall the standard paper tray.
Unusable Device	An unsupported USB device has been connected to the USB accessory port.	Unplug the device from the USB accessory port.

Error Message	Cause	Action
Unusable Device Remove the Device. Turn the power off and back on again.	A defective USB device or a high power consumption USB device has been connected to the USB accessory port.	<ul style="list-style-type: none"> Unplug the device from the USB accessory port. Press and hold  to turn the machine off, and then turn it on again.
USB flash drive not detected	Your machine cannot detect a USB flash memory drive.	Insert a USB flash memory drive into the USB accessory port.
Wrong Drum	The installed drum unit is not correct for your machine.	Remove the drum unit and install a drum unit with the correct supply product code. <i>See Related Information: Replace the Drum Unit.</i>
Wrong Paper Size MP Wrong Paper Size T1 Wrong Paper Size T2 Wrong Paper Size T3	The specified tray ran out of paper during copying and the machine could not feed the same size paper from the next priority tray.	Refill the paper in the paper tray.
Wrong Toner Cartridge	The installed toner cartridge is not correct for your machine.	Remove the toner cartridge from the drum unit, and install a toner cartridge with the correct supply product code. <i>See Related Information: Replace the Toner Cartridge.</i>



Related Information

- [Troubleshooting](#)
 - [Unable to Print or Scan -Transfer Your Faxes](#)

Related Topics:

- [Load and Print Using the Paper Tray](#)
- [Load and Print Using the Multi-purpose Tray \(MP Tray\)](#)
- [Replace Supplies](#)
- [Replace the Toner Cartridge](#)
- [Replace the Drum Unit](#)
- [Clean the Corona Wire](#)

Unable to Print or Scan -Transfer Your Faxes

Related Models: MFC-L5718DN/MFC-L5728DW

If the LCD displays:

- [Cannot Print] ##
- [Cannot Scan] ##

We recommend transferring your faxes to another fax machine or to your computer.

You can also transfer the Fax Journal report to see if there are any faxes you must transfer.



If there is an error message on the LCD after you transfer the faxes, disconnect your Brother machine from the power source for several minutes, and then reconnect it.





Related Information

- [Error and Maintenance Messages](#)
 - [Transfer Faxes to Another Fax Machine](#)
 - [Transfer Faxes to Your Computer](#)
 - [Transfer the Fax Journal Report to Another Fax Machine](#)
-

Transfer Faxes to Another Fax Machine

Related Models: MFC-L5718DN/MFC-L5728DW

You must set up your Station ID before transferring faxes to another fax machine.

1. Press  [Settings] > [All Settings] > [Service] > [Data Transfer] > [Fax Transfer].
2. Do one of the following:
 - If the LCD displays [No Data], there are no faxes left in the machine's memory. Press [Close]. Press .
 - Enter the fax number to which faxes will be forwarded.
3. Press [Fax Start].

Related Information



- [Unable to Print or Scan -Transfer Your Faxes](#)

Related Topics:

- [Set Your Station ID](#)

Transfer Faxes to Your Computer

Related Models: MFC-L5718DN/MFC-L5728DW

1. Make sure you have installed the software and drivers on your computer.
2. Launch  (**Brother Utilities**), and then click the drop-down list and select your model name (if not already selected). Click **PC-FAX** in the left navigation bar, and then click **Receive**.
The **PC-FAX Receive** window appears.
3. Make sure you have set [PC Fax Receive] on the machine.
If faxes are in the machine's memory when you set up PC-Fax Receive, the LCD displays [Send Fax to PC?].
4. Do one of the following:
 - To transfer all faxes to your computer, press [Yes].
 - To exit and leave the faxes in the memory, press [No].
5. Press .

Related Information

- [Unable to Print or Scan -Transfer Your Faxes](#)

Transfer the Fax Journal Report to Another Fax Machine

Related Models: MFC-L5718DN/MFC-L5728DW

You must set up your Station ID before transferring the Fax Journal report to another fax machine.

1. Press  [Settings] > [All Settings] > [Service] > [Data Transfer] > [Report Transfer].
2. Enter the fax number to which the Fax Journal report will be forwarded.
3. Press [Fax Start].



Related Information

- [Unable to Print or Scan -Transfer Your Faxes](#)

Related Topics:

- [Set Your Station ID](#)

Document Jams

- [Document is Jammed in the Top of the ADF Unit](#)
- [Document is Jammed under the Document Cover](#)
- [Remove Small Scraps of Paper Jammed in the ADF](#)

Document is Jammed in the Top of the ADF Unit

1. Remove any paper from the ADF that is not jammed.
2. Open the ADF cover.
3. Pull the jammed document out to the left. If the document rips or tears, be sure you remove any debris or scraps to prevent future jams.

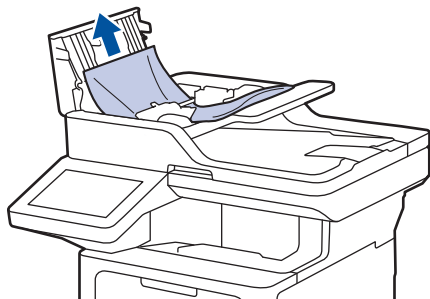

4. Close the ADF cover.
5. Press .





Related Information

- [Document Jams](#)

Document is Jammed under the Document Cover

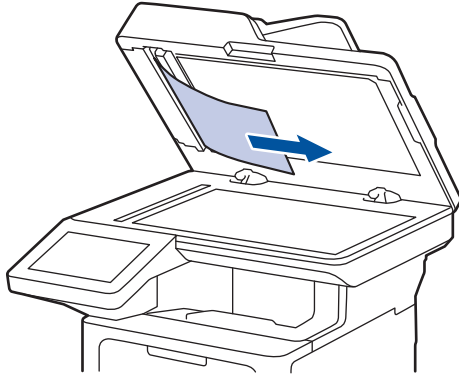
1. Remove any paper from the ADF that is not jammed.
2. Lift the document cover.
3. Pull the jammed document out to the right. If the document rips or tears, be sure you remove any debris or scraps to prevent future jams.



4. Close the document cover.
5. Press .

Related Information

- [Document Jams](#)

Remove Small Scraps of Paper Jammed in the ADF

1. Lift the document cover.
2. Insert a piece of stiff paper, such as cardstock, into the ADF to push any small paper scraps through.
(DCP-L5518DN)

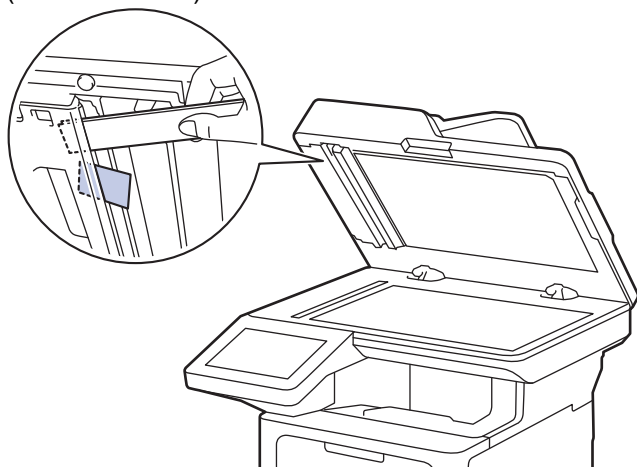

(MFC-L5718DN/MFC-L5728DW)

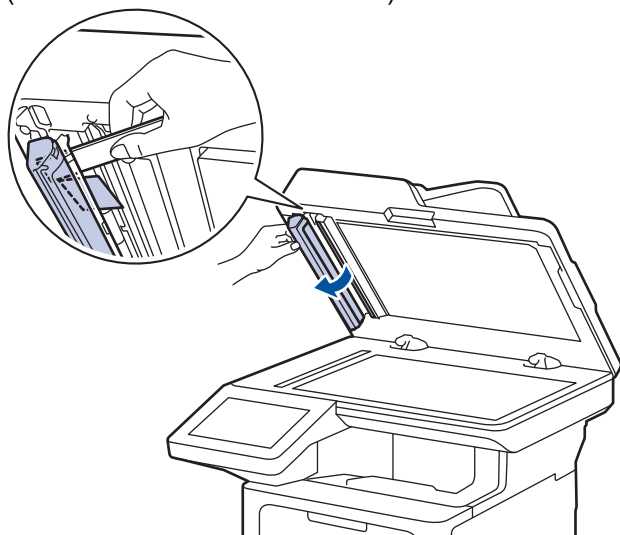

3. Close the document cover.
4. Press .

Related Information

- [Document Jams](#)

Paper Jams

Always remove the remaining paper from the paper tray, fan and straighten the stack when you are adding new paper. This helps prevent paper jams.

- [Clear Paper Jams](#)
- [Paper is Jammed in the MP tray](#)
- [Paper is Jammed in the Paper Tray](#)
- [Paper is Jammed in the Back of the Machine](#)
- [Paper is Jammed inside the Machine](#)
- [Paper is Jammed in the 2-sided Tray](#)

Clear Paper Jams

If paper is jammed or multiple sheets of paper are fed together frequently, do the following:

- Clean the paper pick-up rollers and the separator pad of paper trays.
See Related Information: Clean the Paper Pick-up Rollers.
- Load paper correctly in the tray.
See Related Information: Load Paper.
- Set the correct paper size and paper type on your machine.
See Related Information: Paper Settings.
- Set the correct paper size and paper type on your computer.
See Related Information: Print a Document (Windows).
See Related Information: Print Using AirPrint.
- Use the recommended paper.
See Related Information: Using Special Paper.
See Related Information: Recommended Print Media.



Related Information

- [Paper Jams](#)

Related Topics:

- [Clean the Paper Pick-up Rollers](#)
- [Load Paper](#)
- [Paper Settings](#)
- [Print a Document \(Windows\)](#)
- [Print Using AirPrint](#)
- [Using Special Paper](#)
- [Recommended Print Media](#)

Paper is Jammed in the MP tray

If the machine's control panel or the Status Monitor indicates that there is a jam in the machine's MP tray, follow these steps:

1. Remove the paper from the MP tray.
2. Slowly remove any jammed paper from in and around the MP tray.

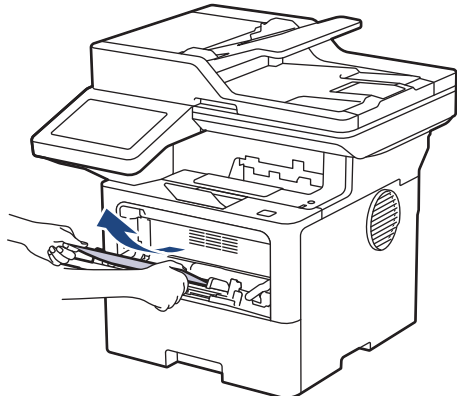

3. Fan the paper stack, and then put it back in the MP tray.
4. Reload paper in the MP tray and make sure the paper stays under the maximum paper mark (1) on both sides of the tray.

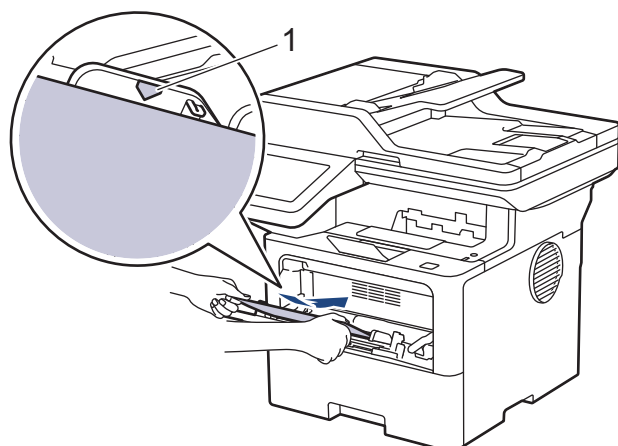

5. Follow the instructions on the machine's LCD.



Related Information

- [Paper Jams](#)

Paper is Jammed in the Paper Tray

If the machine's control panel or the Status Monitor indicates that there is a jam in the paper tray, follow these steps:

1. Pull the paper tray completely out of the machine.

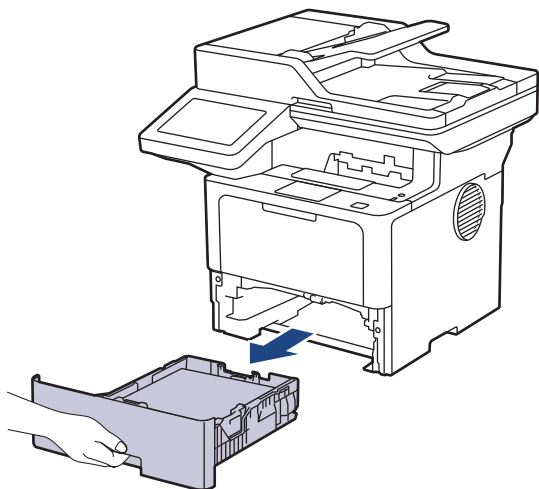

2. Slowly pull out the jammed paper.

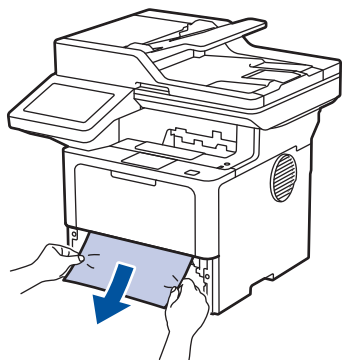

Pulling the jammed paper downwards using both hands allows you to remove the paper more easily.

3. Fan the stack of paper to prevent further jams, and slide the paper guides to fit the paper size. Load paper in the paper tray.

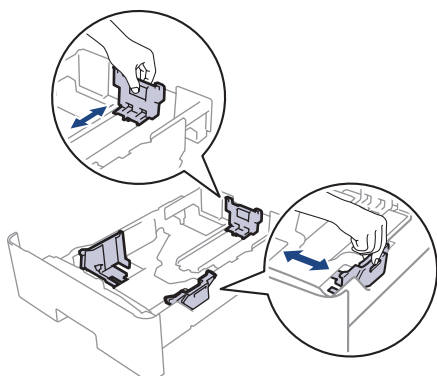

-
4. Make sure the paper is below the maximum paper mark (▼▼▼).

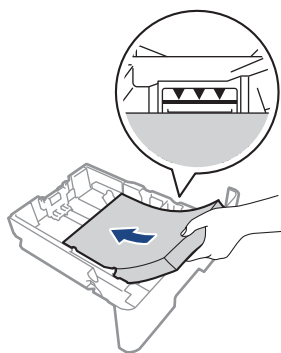

5. Put the paper tray firmly back into the machine.



Related Information

- [Paper Jams](#)

Paper is Jammed in the Back of the Machine

If the machine's control panel or the Status Monitor indicates that there is a jam in the back of the machine (Jam Rear), do the following:

1. Leave the machine turned on for 10 minutes for the internal fan to cool the extremely hot parts inside the machine.
2. Open the back cover.

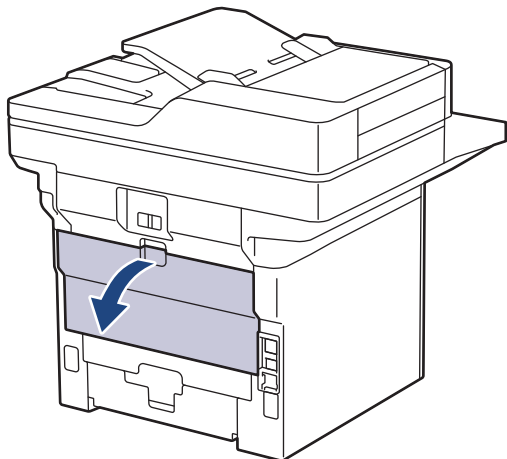

3. Pull the green levers at the left and right sides towards you to release the fuser cover.

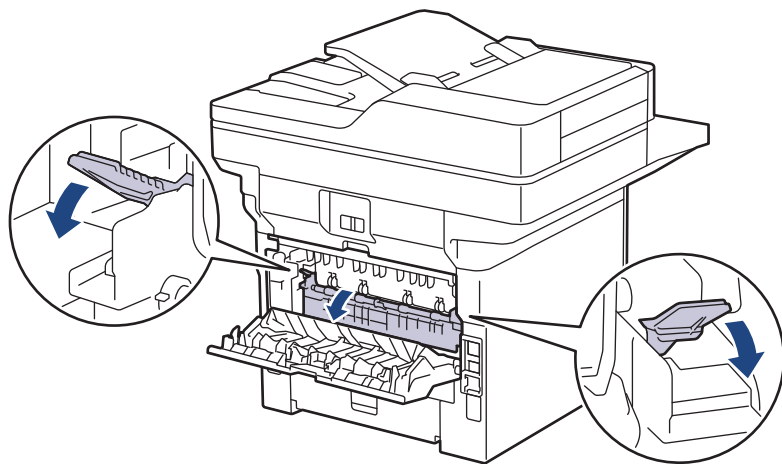

WARNING

HOT SURFACE

The machine's internal parts will be extremely hot. Wait for the machine to cool down before touching them.

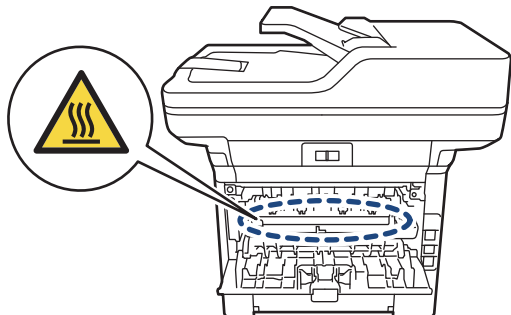

4. Use both hands to gently pull the jammed paper out of the machine.

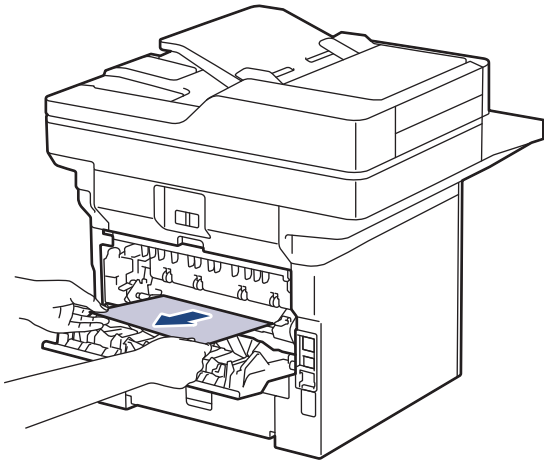

5. Close the fuser cover.

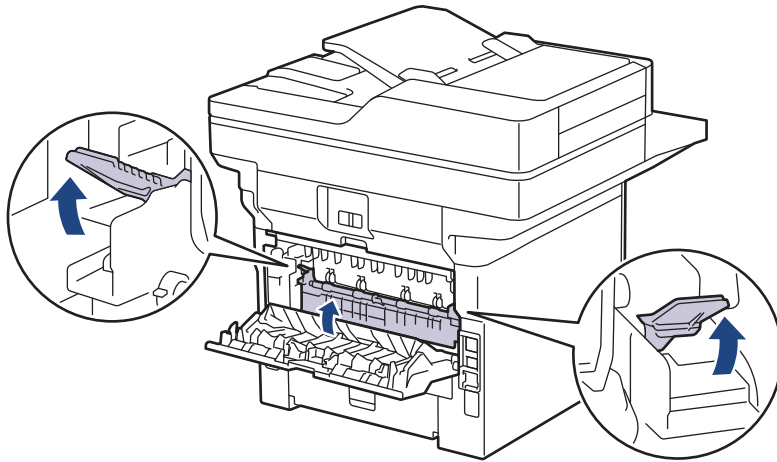

6. Close the back cover until it locks in the closed position.

 **Related Information**

- [Paper Jams](#)

Paper is Jammed inside the Machine

If the machine's control panel or the Status Monitor indicates that there is a jam inside the machine, follow these steps:

1. Leave the machine turned on for 10 minutes for the internal fan to cool the extremely hot parts inside the machine.
2. Open the front cover.

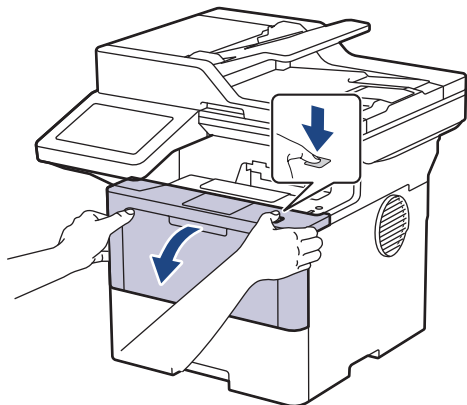

3. Remove the toner cartridge and drum unit assembly.

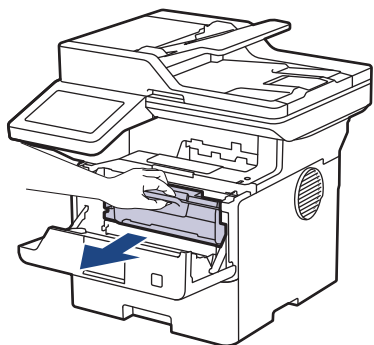

WARNING

HOT SURFACE

The machine's internal parts will be extremely hot. Wait for the machine to cool down before touching them.

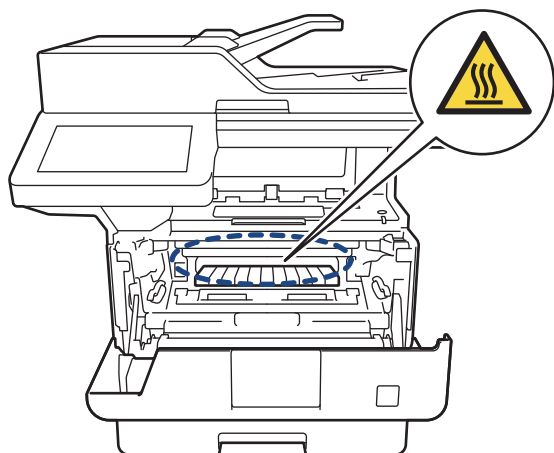

4. Pull out the jammed paper slowly.

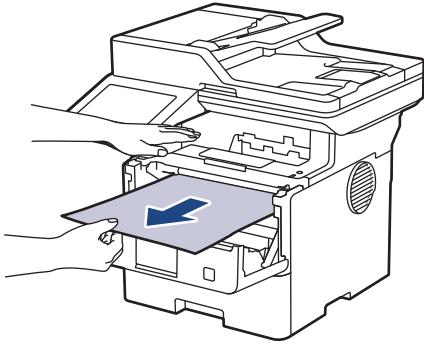

5. Install the toner cartridge and drum unit assembly into the machine.

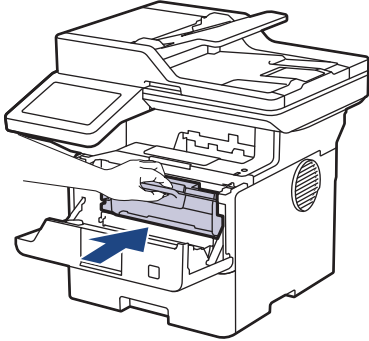

6. Close the front cover.



Related Information

- [Paper Jams](#)

Paper is Jammed in the 2-sided Tray

If the machine's control panel or the Status Monitor indicates that there is a jam in the 2-sided paper tray, follow these steps:

1. Leave the machine turned on for 10 minutes for the internal fan to cool the extremely hot parts inside the machine.
2. Pull the paper tray completely out of the machine.

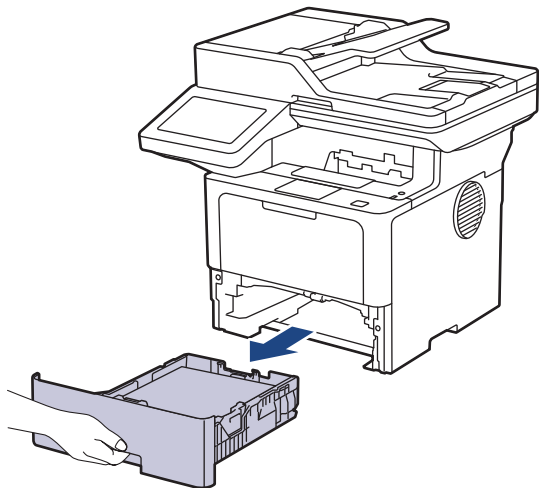

3. At the back of the machine, pull the 2-sided tray completely out of the machine.

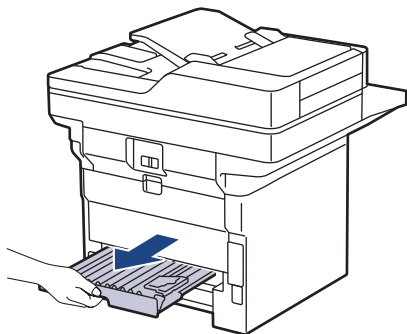

4. Pull the jammed paper out of the machine or out of the 2-sided tray.

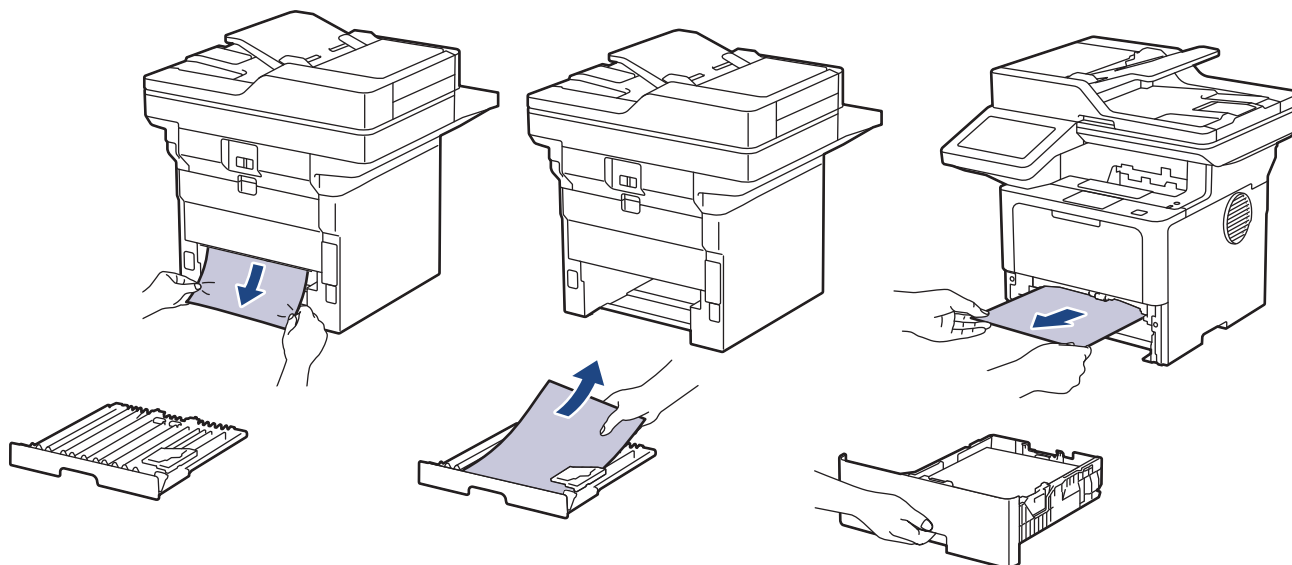

5. Remove paper that may have jammed under the machine due to static electricity.

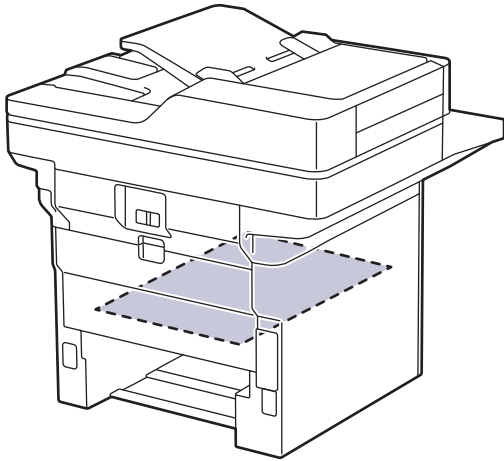

6. If paper is not caught inside the 2-sided tray, open the back cover.

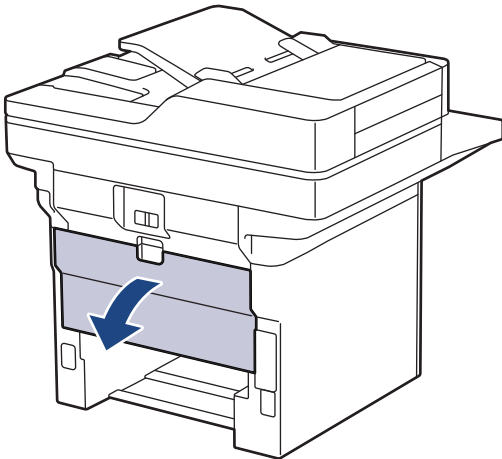

7. Pull the green levers at the left and right sides towards you to release the fuser cover.

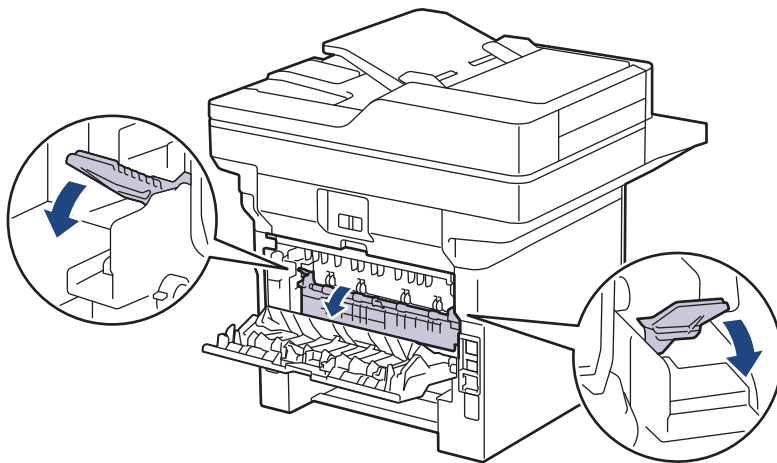

⚠ WARNING

HOT SURFACE

The machine's internal parts will be extremely hot. Wait for the machine to cool down before touching them.

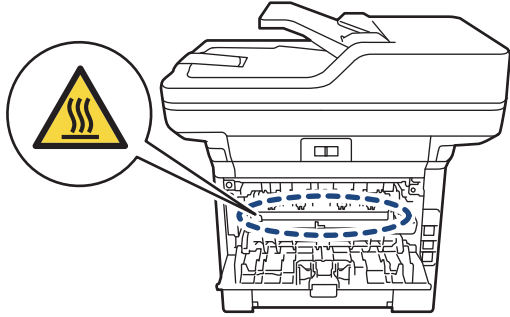

8. Use both hands to gently pull the jammed paper out of the back of the machine.

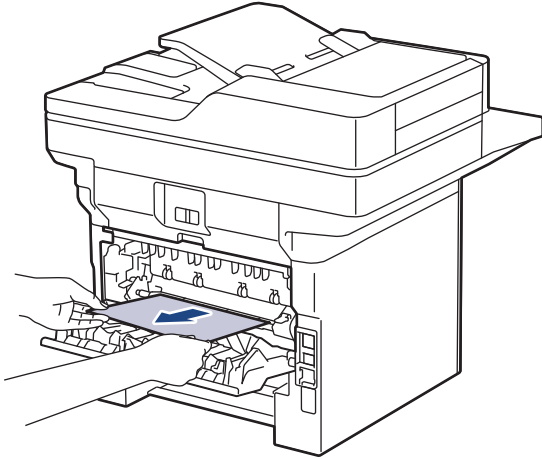

9. Close the fuser cover.

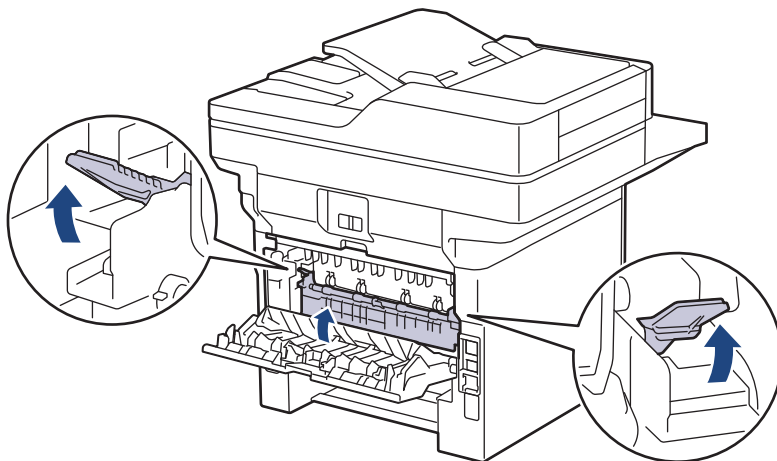



10. Close the back cover until it locks in the closed position.
11. Push the 2-sided tray firmly back into the back of the machine.
12. Push the paper tray firmly back into the front of the machine.

Related Information

- [Paper Jams](#)

Printing Problems

If, after reading the information in this table, you still need help, see the latest troubleshooting tips at support.brother.com/faqs.

Difficulties	Suggestions
No printout	<p>Check the machine is not in Power Off mode.</p> <p>If the machine is in Power Off mode, press , and then send the print data again.</p> <p>Check that the correct printer driver has been installed and selected.</p> <p>Check to see if the Status Monitor or the machine's control panel displays an error.</p> <p>Check that the machine is online:</p> <ul style="list-style-type: none"> • Windows 11 <p>Click  > All apps > Windows Tools > Control Panel. In the Hardware and Sound group, click View devices and printers. Right-click your model's icon, and click See what's printing. If printer driver options appear, select your printer driver. Click Printer in the menu bar and make sure Use Printer Offline is not selected.</p> • Windows 10, Windows Server 2016, Windows Server 2019, and Windows Server 2022 <p>Click  > Windows System > Control Panel. In the Hardware and Sound (Hardware) group, click View devices and printers. Right-click your model's name. Click See what's printing. If printer driver options appear, select your printer driver. Click Printer in the menu bar and make sure that Use Printer Offline is not selected.</p> • Windows Server 2012 R2 <p>Click Control Panel on the Start screen. In the Hardware group, click View devices and printers. Right-click your model's name. Click See what's printing. If printer driver options appear, select your printer driver. Click Printer in the menu bar and make sure Use Printer Offline is not selected.</p> • Windows Server 2012 <p>Move your mouse to the lower right corner of your desktop. When the menu bar appears, click Settings > Control Panel. In the Hardware group, click View devices and printers. Right-click your model's name. Click See what's printing. If printer driver options appear, select your printer driver. Click Printer in the menu bar and make sure that Use Printer Offline is not selected.</p>
The machine is not printing or has stopped printing.	<p>Cancel the print job and clear it from the machine's memory. The printout may be incomplete. Send the print data again.</p> <p><i>See Related Information: Cancel a Print Job.</i></p>
The headers or footers appear when the document displays on the screen but they do not show up when it is printed.	<p>There is an unprintable area on the top and bottom of the page. Adjust the top and bottom margins in your document to allow for this.</p>

Difficulties	Suggestions
The machine prints unexpectedly or it prints garbled text.	Cancel the print job and clear it from the machine's memory. The printout may be incomplete. Send the print data again. <i>See Related Information:Cancel a Print Job.</i>
	Check the settings in your application to make sure they are set up to work with your machine.
	Confirm that the Brother printer driver is selected in your application's Print window.
The machine prints the first couple of pages correctly, then some pages have missing text.	Check the settings in your application to make sure they are set up to work with your machine.
	Your machine is not receiving all of the data sent from the computer. Make sure you connected the interface cable correctly.
The machine does not print on both sides of the paper even though the printer driver setting is 2-sided and the machine supports automatic 2-sided printing.	Check the paper size setting in the printer driver. You must select A4 paper. Supported paper weight is 60 to 105g/m ²
Print speed is too slow.	Reduce the resolution in the printer driver.
	If you have enabled Quiet Mode, disable it in the printer driver or the machine's menu.
	When printing continuously, the printing speed may be automatically reduced to lower the temperature inside the machine.
The machine does not feed paper.	If there is paper in the paper tray, make sure it is straight. If the paper is curled, straighten it. Sometimes it is helpful to remove the paper, turn the stack over and place it back in the paper tray.
	Fan the stack of paper well and place it back to the paper tray.
	Reduce the amount of paper in the paper tray, and then try again.
	(For models with MP Tray) Make sure MP Tray is not selected for Paper Source in the printer driver.
	Clean the paper pick-up rollers.
The machine does not feed paper from the MP tray. (For models with MP Tray)	Fan the paper well and place it back in the MP tray.
	Make sure MP Tray is selected as the Paper Source in the printer driver.
The machine does not feed envelopes.	Load envelopes in the MP tray. Your application must be set to print the envelope size you are using. This is usually done in the Page Setup or Document Setup menu of your application.
Print position is misaligned with the letterhead or preprinted objects.	Adjust the print position using the Print Position setting for each paper tray.



Related Information

- [Troubleshooting](#)

Related Topics:



- [Monitor the Status of the Machine from Your Computer \(Windows\)](#)
- [Cancel a Print Job](#)
- [Load and Print Using the Paper Tray](#)
- [Clean the Paper Pick-up Rollers](#)





-
- Load and Print Using the Multi-purpose Tray (MP Tray)
-

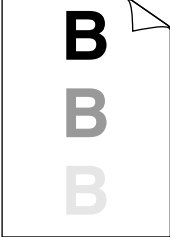
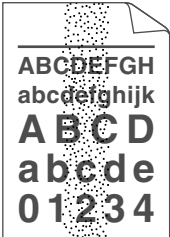

Improve the Print Quality

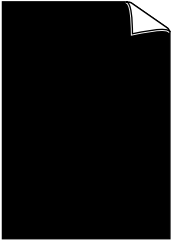

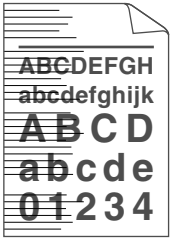

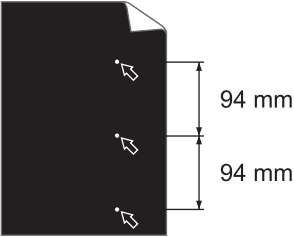
If you have a print quality problem, print a test page first. If the printout looks good, the problem is probably not the machine. Check the interface cable connections and try printing a different document. If the printout or test page printed from the machine has a quality problem, check the examples of poor print quality and follow the recommendations in the table.

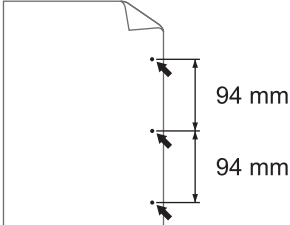
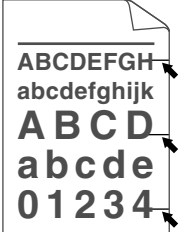
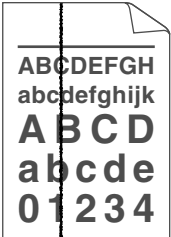
1. To get the best print quality, we suggest using recommended print media. Make sure you use paper that meets our specifications.
2. Check that the toner cartridge and drum unit are installed correctly.

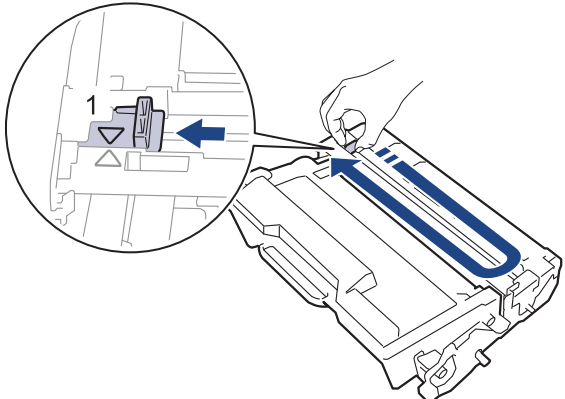
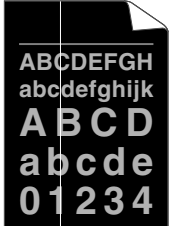
Examples of poor print quality	Recommendation
 <p>ABCDEF GH abcde fghijk A B C D a b c d e 0 1 2 3 4</p> <p>Faint</p>	<ul style="list-style-type: none"> • If the machine displays the Replace Toner status, install a new toner cartridge. • Check the machine's environment. Conditions such as humidity, high temperatures, and so on, may cause this print fault. • If the whole page is too light, Toner Save mode may be turned on. Turn Toner Save mode off in the machine's menu settings or the printer driver. • Clean the drum unit. • Clean the corona wire on the drum unit. • Replace the toner cartridge with a new toner cartridge. • Replace the drum unit with a new drum unit.
 <p>ABCDEF GH abcde fghijk A B C D a b c d e 0 1 2 3 4</p> <p>Grey background</p>	<ul style="list-style-type: none"> • Check the machine's environment. Conditions such as high temperatures and high humidity can increase the amount of background shading. • Clean the drum unit. • Replace the toner cartridge with a new toner cartridge. • Replace the drum unit with a new drum unit.
 <p>B B B</p> <p>Ghosting images</p>	<ul style="list-style-type: none"> • Check the machine's environment. Conditions such as low humidity and low temperatures may cause this print quality problem. • Select the appropriate media type in the printer driver. • Clean the drum unit. • Replace the drum unit with a new drum unit. • Replace the toner cartridge with a new toner cartridge. • The fuser unit may be contaminated. Contact Brother customer service.
 <p>ABCDEF GH abcde fghijk A B C D a b c d e 0 1 2 3 4</p> <p>Toner specks</p>	<ul style="list-style-type: none"> • Make sure the media type setting in the driver matches the type of paper you are using. • Clean the drum unit. • The toner cartridge may be damaged. Replace the toner cartridge with a new toner cartridge. • The drum unit may be damaged. Replace the drum unit with a new drum unit. • The fuser unit may be contaminated. Contact Brother customer service.

Examples of poor print quality	Recommendation
 <p data-bbox="406 409 545 436">Hollow print</p>	<ul data-bbox="817 168 1474 443" style="list-style-type: none"> • Select Thick Paper mode in the printer driver or use thinner paper than you are currently using. • Select the appropriate media type from the paper type options on your machine. • Check the machine's environment. Conditions such as high humidity can cause hollow print. • The drum unit may be damaged. Replace the drum unit with a new drum unit.
 <p data-bbox="427 705 525 732">All black</p>	<ul data-bbox="817 463 1356 571" style="list-style-type: none"> • Clean the corona wire inside the drum unit. • The drum unit may be damaged. Replace the drum unit with a new drum unit.
 <p data-bbox="319 985 633 1012">White lines across the page</p>	<ul data-bbox="817 748 1474 1064" style="list-style-type: none"> • Select the appropriate media type in the printer driver. • Select the appropriate media type from the paper type options on your machine. • The problem may disappear by itself. Print several blank pages to clear this problem, especially if the machine has not been used for a long time. • Clean the drum unit. • The drum unit may be damaged. Replace the drum unit with a new drum unit.
 <p data-bbox="347 1319 601 1346">Lines across the page</p>	<ul data-bbox="817 1081 1356 1189" style="list-style-type: none"> • Clean the drum unit. • The drum unit may be damaged. Replace the drum unit with a new drum unit.
 <p data-bbox="220 1601 730 1628">White lines, bands or ribbing across the page</p>	<ul data-bbox="817 1364 1474 1563" style="list-style-type: none"> • Check the machine's environment. Conditions such as high humidity and high temperatures may cause this print quality problem. • Clean the drum unit. • If the problem is not solved after printing a few pages, replace the drum unit with a new drum unit.
 <p data-bbox="146 1883 802 1910">White spots on black text and graphics at 94 mm intervals</p>	<ul data-bbox="817 1646 1474 1910" style="list-style-type: none"> • Make 10-15 copies of a blank, white sheet of paper. If the problem is not solved after printing the blank pages, the drum unit may have foreign material, such as glue from a label, stuck on the drum. Clean the drum unit. <i>See Related Information: Clean the Drum Unit.</i> • The drum unit may be damaged. Replace the drum unit with a new drum unit.

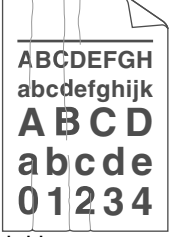
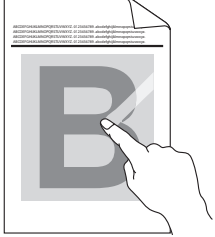
Examples of poor print quality	Recommendation
 <p data-bbox="300 405 651 434">Black spots at 94 mm intervals</p>	
 <p data-bbox="277 687 673 716">Black toner marks across the page</p>	<ul style="list-style-type: none"> • If you use label sheets for laser printers, the glue from the sheets may sometimes stick to the drum surface. Clean the drum unit. <i>See Related Information: Clean the Drum Unit.</i> • If you used paper that has clips or staples, the drum unit may be damaged. • If the unpacked drum unit is in direct sunlight (or room light for long periods of time), the unit may be damaged. • Clean the drum unit. • The toner cartridge may be damaged. Replace the toner cartridge with a new toner cartridge. • The drum unit may be damaged. Replace the drum unit with a new drum unit.
 <p data-bbox="325 1202 625 1232">Black lines down the page</p> <p data-bbox="207 1238 743 1267">Printed pages have toner stains down the page</p>	<ul style="list-style-type: none"> • Clean the corona wire inside the drum unit by sliding the green tab. <p data-bbox="852 1048 1452 1126"> Make sure the green tab of the corona wire is in the Home position (1).</p>  <ul style="list-style-type: none"> • Wipe the scanner glass strip with a dry lint free soft cloth. • The toner cartridge may be damaged. Replace the toner cartridge with a new toner cartridge. • The drum unit may be damaged. Replace the drum unit with a new drum unit. • The fuser unit may be contaminated. Contact Brother customer service.
	<ul style="list-style-type: none"> • Make sure there is no foreign material, such as a torn piece of paper, sticky notes or dust, inside the machine and around the toner cartridge and drum unit. • The toner cartridge may be damaged. Replace the toner cartridge with a new toner cartridge. • The drum unit may be damaged.

Examples of poor print quality	Recommendation
<p data-bbox="325 168 625 197">White lines down the page</p>  <p data-bbox="392 450 560 479">Image skewed</p>	<p data-bbox="855 168 1353 197">Replace the drum unit with a new drum unit.</p> <ul data-bbox="817 215 1469 721" style="list-style-type: none"> • Set the document correctly in the ADF or on the scanner glass if the skew only occurs when making copies. • Make sure the paper or other print media is loaded correctly in the paper tray and the guides are not too tight or too loose against the paper stack. • Set the paper guides correctly. • The paper tray may be too full. • Check the paper type and quality. • Check for loose objects such as torn paper inside the machine. • If the problem only occurs during automatic 2-sided printing, check for torn paper in the 2-sided tray. Verify the 2-sided tray is inserted completely and the back cover is closed completely.
 <p data-bbox="352 987 600 1016">Curled or wavy image</p>	<ul data-bbox="817 741 1469 1099" style="list-style-type: none"> • Check the paper type and quality. High temperatures and high humidity will cause paper to curl. • If you do not use the machine often, the paper may have been in the paper tray too long. Turn over the stack of paper in the paper tray. Also, fan the paper stack, and then rotate the paper 180° in the paper tray. • Open the back cover (face up output tray) to let the printed paper exit onto the face up output tray. • Choose Reduce Paper Curl mode in the printer driver when you do not use our recommended print media.
 <p data-bbox="360 1357 592 1386">Wrinkles or creases</p>	<ul data-bbox="817 1122 1437 1256" style="list-style-type: none"> • Make sure paper is loaded correctly. • Check the paper type and quality. • Turn over the stack of paper in the tray or rotate the paper 180° in the input tray.
 <p data-bbox="416 1637 536 1666">Poor fixing</p>	<ul data-bbox="817 1402 1453 1525" style="list-style-type: none"> • Make sure the media type setting in the printer driver matches the type of paper you are using. • Select Improve Toner Fixing mode in the printer driver. <p data-bbox="855 1536 1461 1659">If this selection does not provide enough improvement, change the printer driver setting in Media Type to a thick setting. If you are printing an envelope, select Env. Thick in the media type setting.</p>
 <p data-bbox="376 2031 576 2060">Envelope creases</p>	<ul data-bbox="817 1684 1453 1818" style="list-style-type: none"> • Make sure envelopes are printed with the back cover (face up output tray) opened. • (For models with MP Tray) Make sure envelopes are fed only from the MP tray.



Related Information

- [Troubleshooting](#)

Related Topics:

- [Test Print](#)
 - [Clean the Drum Unit](#)
 - [Reduce Toner Consumption](#)
 - [Replace the Toner Cartridge](#)
 - [Replace the Drum Unit](#)
 - [Clean the Scanner](#)
-

Telephone and Fax Problems

Related Models: MFC-L5718DN/MFC-L5728DW

Telephone Line or Connections

Difficulties	Suggestions
Dialling does not work. (No dial tone)	Check all line cord connections. Make sure the telephone line cord is plugged into the telephone wall socket and the LINE socket of the machine. Make sure your machine has a dial tone by pressing the Hook button in Fax mode. If you subscribe to DSL or VoIP services, contact your service provider for connection instructions.
	Change the Tone/Pulse setting.
	Send a manual fax by pressing Hook or Hook/Hold button, and dialing the number. Wait to hear fax-receiving tones before pressing Start button.
	If there is no dial tone, connect a known working telephone and telephone line cord to the socket. Then lift the external telephone's handset and listen for a dial tone. If there is still no dial tone, ask your telephone company to check the line and/or wall socket.
The machine does not answer when called.	Make sure the machine is in the correct receive mode for your setup. Check for a dial tone. If possible, call your machine to hear it answer. If there is still no answer, check that the telephone line cord is plugged into the telephone wall socket and the LINE socket of the machine. Make sure your machine has a dial tone by pressing the Hook button in Fax mode. If there is no ringing when you call your machine, ask your telephone company to check the line.

Handling Incoming Calls

Difficulties	Suggestions
Sending a Fax Call to the machine.	When your machine answers, hang up.
Custom features on a single line.	If you have Call Waiting, Voice Mail, an answering machine, an alarm system or other custom feature on a single telephone line with your machine, it may create a problem sending or receiving faxes. For Example: If you subscribe to Call Waiting or some other custom service and its signal comes through the line while your machine is sending or receiving a fax, the signal can temporarily interrupt or disrupt the faxes. Brother's ECM (Error Correction Mode) feature should help overcome this problem. This condition is related to the telephone system industry and is common to all devices that send and receive information on a single, shared line with custom features. If avoiding a slight interruption is crucial to your business, we recommend using a separate telephone line with no custom features.

Receiving Faxes

Difficulties	Suggestions
Cannot receive a fax.	Check all line cord connections. Make sure the telephone line cord is plugged into the telephone wall socket and the LINE socket of the machine. If you subscribe to DSL or VoIP services, contact your service provider for connection instructions. If you are using a VoIP system, try changing the VoIP setting to <i>Basic (for VoIP)</i> . This will lower modem speed and turn off Error Correction Mode (ECM).
	Make sure your machine has a dial tone by pressing Hook or Hook/Hold button in Fax mode. If you hear static or interference on your fax line, contact your local telephone provider.

Difficulties	Suggestions
Cannot receive a fax.	<p>Make sure the machine is in the correct Receive Mode. This is determined by the external devices and telephone subscriber services you have on the same line as the Brother machine.</p> <ul style="list-style-type: none"> If you have a dedicated fax line and want your Brother machine to automatically answer all incoming faxes, you should select Fax Auto mode. If your Brother machine shares a line with other telephones and you want it to automatically answer all incoming faxes, you should select the Fax Auto mode. In Fax Auto mode, your Brother machine will receive faxes automatically and produce a pseudo/double-ring to alert you to answer voice calls. If you do not want your Brother machine to answer any incoming faxes automatically, you should select the Manual mode. In Manual mode, you must answer every incoming call and activate the machine to receive faxes.
	<p>Another device or service at your location may be answering the call before your Brother machine answers. To test this, lower the Ring Delay setting:</p> <ul style="list-style-type: none"> If the Receive Mode is set to Fax Auto, reduce the Ring Delay to one ring. <i>See Related Information: Set the Number of Rings Before the Machine Answers (Ring Delay).</i> If the Receive Mode is set to Manual, DO NOT adjust the Ring Delay setting.
	<p>Have someone send you a test fax:</p> <ul style="list-style-type: none"> If you received the test fax successfully, your machine is operating correctly. Remember to reset your Ring Delay or answering machine setting back to your original setting. If receiving problems recur after resetting the Ring Delay, then a person, device, or subscriber service is answering the fax call before the machine has a chance to answer. If you were not able to receive the fax, then another device or subscriber service may be interfering with your fax reception or there may be a problem with your fax line.
	<p>Make sure your Brother machine's Fax Detect feature is turned On. Fax Detect is a feature that allows you to receive a fax even if you answered the call on an external or extension telephone.</p>
	<p>If you often get transmission errors due to possible interference on the telephone line or if you are using a VoIP system, try changing the Compatibility setting to <i>Basic (for VoIP)</i>.</p>
	<p>Contact your administrator to check your Secure Function Lock settings.</p>

Sending Faxes

Difficulties	Suggestions
Cannot send a fax.	<p>Check all line cord connections. Make sure the telephone line cord is plugged into the telephone wall socket and the LINE socket of the machine. Make sure your machine has a dial tone by pressing the Hook button in Fax mode. If you subscribe to DSL or VoIP services, contact your service provider for connection instructions.</p>
	<p>Make sure you pressed Fax and the machine is in Fax mode.</p>
	<p>Contact your administrator to check your Secure Function Lock settings.</p>
	<p>Ask the other party to check that the receiving machine has paper.</p>
Poor quality of sent faxes.	<p>Try changing your resolution to Fine. Make a copy to check your machine's scanner operation. If the copy quality is poor, clean the scanner.</p>
Sent faxes are blank.	<p>Make sure you are loading the document correctly. When using the ADF, the document should be face up. When using the scanner glass, the document should be face down.</p>
Vertical black lines when sending a fax.	<p>Black vertical lines on faxes you send are typically caused by dirt or correction fluid on the glass strip. Clean the glass strip.</p>

Printing received faxes

Difficulties	Suggestions
<ul style="list-style-type: none"> • Condensed print • Horizontal streaks • Top and bottom sentences are cut off • Missing lines 	<p>This is usually caused by a poor telephone connection. Do a test copy; if your copy looks good, you probably had a bad connection, with static or interference on the telephone line. Ask the other party to send the fax again.</p>
<p>Vertical black lines when receiving</p>	<p>The corona wire may be dirty. Clean the corona wire in the drum unit.</p> <p>The sender's scanner may be dirty. Ask the sender to make a copy to see if the problem is with the sending machine. Try receiving from another fax machine.</p>
<p>Received faxes appear as split or blank pages.</p>	<p>Left and right margins are cut off or a single page is printed on two pages.</p> <p>If the received faxes are divided and printed on two pages or if you get an extra blank page, your paper size setting may not be correct for the paper you are using.</p> <p>Turn Auto Reduction on.</p>





Related Information

- [Troubleshooting](#)
 - [Set Dial Tone Detection](#)
 - [Set Telephone Line Compatibility for Interference and VoIP Systems](#)

Set Dial Tone Detection

Related Models: MFC-L5718DN/MFC-L5728DW

Setting the Dial Tone to [Detection] shortens the Dial Tone detect pause.

1. Press  [Settings] > [All Settings] > [Initial Setup] > [Dial Tone].
2. Press [Detection] or [No Detection].
3. Press .

Related Information

- [Telephone and Fax Problems](#)



Set Telephone Line Compatibility for Interference and VoIP Systems

Related Models: MFC-L5718DN/MFC-L5728DW

Problems sending and receiving faxes due to possible interference on the telephone line may be solved by reducing the modem speed to minimise errors in fax transmission. If you are using a Voice over IP (VoIP) service, we recommend changing the compatibility to Basic (for VoIP).



- VoIP is a type of phone system that uses an Internet connection, rather than a traditional phone line.
- Telephone providers frequently bundle VoIP together with Internet and cable services.

1. Press  [Settings] > [All Settings] > [Initial Setup] > [Compatibility].
2. Press the option you want.
 - Select [High] to set the modem speed to 33600 bps.
 - Select [Normal] to set the modem speed to 14400 bps.
 - Select [Basic (for VoIP)] to reduce the modem speed to 9600 bps and turn off Error Correction Mode (ECM). Unless interference is a recurring problem on your telephone line, you may prefer to use this option only when needed.
3. Press .



Related Information

- [Telephone and Fax Problems](#)

Network Problems

- [Error Messages](#)
- [Use the Network Connection Repair Tool \(Windows\)](#)
- [Check Your Machine's Network Settings](#)
- [I Cannot Complete the Wireless Network Setup Configuration](#)
- [My Machine Cannot Print, Scan, or Use the PC-FAX Receive Function over the Network](#)
- [I Want to Check that My Network Devices are Working Correctly](#)

Error Messages

The most common error messages are shown in the table.

Error Messages	Cause	Action
The maximum number of devices are already connected using Wi-Fi Direct.	Four mobile devices are already connected to the Wi-Fi Direct network when the Brother machine is the Group Owner.	After the current connection between your Brother machine and another mobile device has shut down, try to configure the Wi-Fi Direct settings again. You can confirm the connection status by printing the Network Configuration Report.
Authentication Error, contact your administrator.	Your authentication setting for the Store Print Log to Network feature is not correct.	<ul style="list-style-type: none"> Make sure the Username and Password in Authentication Setting are correct. If the username is part of a domain, enter the username in one of the following styles: user@domain or domain\user. Make sure the time of the log file server matches the time from the SNTP server, or the Date&Time settings. Make sure the SNTP time server settings are configured correctly so the time matches the time used for authentication by Kerberos or NTLMv2. If there is no SNTP server, make sure the Date&Time and Time Zone settings are set correctly using Web Based Management or the control panel so the machine matches the time being used by the server providing the authentication.
Check User ID and Password.	The Kerberos Authentication error.	Make sure you have entered a correct user name and a password for the Kerberos server. For more information on the Kerberos server settings, contact your network administrator.
	The date, time and time zone settings of the Brother machine are not correct.	Confirm your machine's date, time, and time zone settings.
	The DNS server configuration is not correct.	Contact your network administrator for the information on the DNS server settings.
	The Brother machine cannot connect to the Kerberos server.	Contact your network administrator for the information on the Kerberos server settings.
Connection Error	Other devices are trying to connect to the Wi-Fi Direct network at the same time.	Make sure there are no other devices trying to connect to the Wi-Fi Direct network, and then try to configure the Wi-Fi Direct settings again.
Connection Failed	The Brother machine and your mobile device cannot communicate during the Wi-Fi Direct network configuration.	<ul style="list-style-type: none"> Move the mobile device closer to your Brother machine. Move your Brother machine and the mobile device to an obstruction-free area. If you are using the PIN Method of WPS, make sure you have entered the correct PIN.
File Access Error, contact your administrator.	The Brother machine cannot access the destination folder for the Store Print Log to Network feature.	<ul style="list-style-type: none"> Make sure the destination folder name is correct. Make sure the destination folder is write-enabled. Make sure the print log file is not locked. If it is, contact your network administrator.
	In Web Based Management, you have selected the Cancel Print option in the Error Detection Setting section of the Store Print Log to Network feature.	Wait for about 60 seconds until this message disappears from the LCD.

Error Messages	Cause	Action
No Device	When configuring the Wi-Fi Direct network, the Brother machine cannot find your mobile device.	<ul style="list-style-type: none"> • Make sure your machine and mobile device are in the Wi-Fi Direct mode. • Move the mobile device closer to your Brother machine. • Move your Brother machine and the mobile device to an obstruction-free area. • If you are manually configuring the Wi-Fi Direct network, make sure you have entered the correct password. • If your mobile device has a configuration page for obtaining an IP address, make sure your mobile device's IP address has been configured via DHCP.
Server Timeout, contact your administrator.	The Brother machine cannot connect to the server for the Store Print Log to Network feature.	<ul style="list-style-type: none"> • Make sure your server address is correct. • Make sure your server is connected to the network. • Make sure the machine is connected to the network.
Server Timeout	The Brother machine cannot connect to the LDAP server.	<ul style="list-style-type: none"> • Make sure your server address is correct. • Make sure your server is connected to the network. • Make sure the machine is connected to the network.
	The Brother machine cannot connect to the Active Directory server.	<ul style="list-style-type: none"> • Make sure your server address is correct. • Make sure your server is connected to the network. • Make sure the machine is connected to the network.
Wrong Date & Time, contact your administrator.	The Brother machine does not obtain the time from the SNTP time server or you have not configured the Date&Time for the machine.	<ul style="list-style-type: none"> • Make sure the settings to access the SNTP time server are configured correctly in Web Based Management. • Confirm the Date&Time settings of your machine are correct in Web Based Management.
Internal Error	The Brother machine's LDAP protocol is disabled.	Confirm your authentication method, and then enable the necessary protocol setting in Web Based Management.
	The Brother machine's CIFS protocol is disabled.	



Related Information

- [Network Problems](#)

Related Topics:

- [Print the Network Configuration Report](#)

Use the Network Connection Repair Tool (Windows)

Use the Network Connection Repair Tool to fix the Brother machine's network settings. It will assign the correct IP address and Subnet Mask.

Make sure your machine is turned on and is connected to the same network as your computer.

1. Launch  (**Brother Utilities**), and then click the drop-down list and select your model name (if not already selected).
2. Click **Tools** in the left navigation bar, and then click **Network Connection Repair Tool**.
3. Follow the on-screen instructions.
4. Check the diagnosis by printing the Network Configuration Report or the Printer Settings page.



The Network Connection Repair Tool will start automatically if you select the **Enable Connection Repair Tool** option in the Status Monitor. Right-click the Status Monitor screen, and then click **Other Settings > Enable Connection Repair Tool**. This is not recommended when your network administrator has set the IP address to Static, since it will automatically change the IP address.

If the correct IP address and the Subnet Mask are still not assigned even after using the Network Connection Repair Tool, ask your network administrator for this information.



Related Information

- [Network Problems](#)

Related Topics:

- [Print the Network Configuration Report](#)
- [My Machine Cannot Print, Scan, or Use the PC-FAX Receive Function over the Network](#)
- [I Want to Check that My Network Devices are Working Correctly](#)

Check Your Machine's Network Settings

- [Print the Network Configuration Report](#)

I Cannot Complete the Wireless Network Setup Configuration

Related Models: MFC-L5728DW

Turn your wireless router off and back on. Then, try to configure the wireless settings again. If you are unable to resolve the problem, follow the instructions below:

Investigate the problem using the WLAN Report.

Cause	Action	Interface
Your security settings (SSID/ Network Key) are not correct.	<p>Confirm the security settings using Wireless Setup Helper (Windows). For more information and to download the utility, go to your model's Downloads page at support.brother.com.</p> <p>Select and confirm that you are using the correct security settings.</p> <ul style="list-style-type: none"> - See the instructions supplied with your wireless LAN access point/router for information on how to find the security settings. - The manufacturer's name or model number of the wireless LAN access point/router may be used as the default security settings. - Consult with the access point/router manufacturer, your Internet provider, or network administrator. 	Wireless
Your Brother machine's MAC address is not allowed.	<p>Confirm that the Brother machine's MAC Address is allowed in the filter.</p> <p>You can find the MAC Address on your Brother machine's control panel.</p>	Wireless
Your wireless LAN access point/router is in Stealth mode (not broadcasting the SSID).	<ul style="list-style-type: none"> • Enter the correct SSID or Network Key manually. • Check the SSID or the Network Key in the instructions supplied with your wireless LAN access point/router and reconfigure the wireless network setup. 	Wireless
Your security settings (SSID/ password) are not correct.	<p>Confirm the SSID and password.</p> <p>When you are configuring the network manually, the SSID and password are displayed on your Brother machine. If your mobile device supports the manual configuration, the SSID and password will be displayed on your mobile device's screen.</p>	Wi-Fi Direct
You are using Android™ 4.0.	<p>If your mobile device disconnects (approximately six minutes after using Wi-Fi Direct), try the one-push configuration using WPS (recommended) and set the Brother machine as a Group Owner.</p>	Wi-Fi Direct
Your Brother machine is placed too far from your mobile device.	<p>Move your Brother machine within about 3.3 feet (1 metre) of the mobile device when you configure the Wi-Fi Direct network settings.</p>	Wi-Fi Direct
There are some obstructions (walls or furniture, for example) between your machine and the mobile device.	<p>Move your Brother machine to an obstruction-free area.</p>	Wi-Fi Direct
There is a wireless computer, Bluetooth®-supported device, microwave oven, or digital cordless phone near the Brother machine or your mobile device.	<p>Move other devices away from the Brother machine or your mobile device.</p>	Wi-Fi Direct
You have checked and tried all of the above, but your Brother machine still cannot	<ul style="list-style-type: none"> • Turn your Brother machine off and back on. Then, try to configure the Wi-Fi Direct settings again. 	Wi-Fi Direct

Cause	Action	Interface
complete the Wi-Fi Direct configuration.	<ul style="list-style-type: none">If you are using your Brother machine as a client, confirm how many devices are allowed on the current Wi-Fi Direct network, and then check how many devices are connected.	

For Windows

If your wireless connection has been interrupted, and you have checked and tried all of the above, we recommend using the Network Connection Repair Tool.



Related Information



- [Network Problems](#)

Related Topics:

- [Configure Your Machine for a Wireless Network When the SSID Is Not Broadcast](#)
 - [Use Wi-Fi Direct®](#)
-

My Machine Cannot Print, Scan, or Use the PC-FAX Receive Function over the Network

Cause	Action	Interface
Your security software blocks your machine's access to the network. (The network scanning feature does not work.)	<ul style="list-style-type: none"> • Windows Configure the third-party Security/Firewall Software to allow network scanning. To add port 54925 for network scanning, type the information below: <ul style="list-style-type: none"> - In Name: Type any description, for example Brother NetScan. - In Port number: Type 54925. - In Protocol: UDP is selected. See the instruction manual that came with your third-party Security/Firewall Software or contact the software manufacturer. • Mac (Brother iPrint&Scan) In the Finder menu bar, click Go > Applications, and then double-click the Brother iPrint&Scan icon. The Brother iPrint&Scan window appears. Click the Select your Machine button, and then follow the on-screen instructions to reselect your network machine. 	Wired/Wireless
Your security software blocks your machine's access to the network. (The network PC-Fax Receive feature does not work.) (Windows)	<p>Set the third-party Security/Firewall Software to allow PC-FAX Rx. To add port 54926 for Network PC-FAX Rx, type the information below:</p> <ul style="list-style-type: none"> • In Name: Type any description, for example Brother PC-FAX Rx. • In Port number: Type 54926. • In Protocol: UDP is selected. <p>See the instruction manual that came with your third-party Security/Firewall Software or contact the software manufacturer.</p>	Wired/Wireless
Your security software blocks your machine's access to the network.	<p>Some security software might block access without showing a security alert dialog box even after successful installation.</p> <p>To allow access, see the instructions for your security software or ask the software manufacturer.</p>	Wired/Wireless
Your Brother machine was not assigned an available IP address.	<ul style="list-style-type: none"> • Confirm the IP address and the Subnet Mask. Verify that both the IP addresses and Subnet Masks of your computer and the Brother machine are correct and located on the same network. For more information about how to verify the IP address and the Subnet Mask, ask your network administrator. • Windows Confirm the IP address and the Subnet Mask using the Network Connection Repair Tool. 	Wired/Wireless
A failed print job is still in your computer's print queue.	<ul style="list-style-type: none"> • If a failed print job is still in your computer's print queue, delete it. • Otherwise, double-click the printer icon in the following folder and cancel all documents: <ul style="list-style-type: none"> - Windows 11 	Wired/Wireless

Cause	Action	Interface
	<p>Click  > All apps > Windows Tools > Control Panel. In the Hardware and Sound group, click View devices and printers.</p> <ul style="list-style-type: none"> - Windows 10, Windows Server 2016, Windows Server 2019, and Windows Server 2022 <p>Click  > Windows System > Control Panel. In the Hardware and Sound (Hardware) group, click View devices and printers.</p> <ul style="list-style-type: none"> - Windows Server 2012 R2 <p>Click Control Panel on the Start screen. In the Hardware group, click View devices and printers.</p> <ul style="list-style-type: none"> - Windows Server 2012 <p>Move your mouse to the lower right corner of your desktop. When the menu bar appears, click Settings > Control Panel. In the Hardware group, click View devices and printers > Printers.</p> <ul style="list-style-type: none"> - Mac <p>Click System Preferences > Printers & Scanners.</p>	
Your machine is not connected to the wireless network.	Print the WLAN Report to check the error code on the printed report. See <i>Related Information: Print the WLAN Report</i> .	Wireless

If you have checked and tried all of the above, but you are still having problems, uninstall the drivers (Windows) and the software and reinstall the latest ones.



Related Information

- [Network Problems](#)

Related Topics:

- [Print the WLAN Report](#)
- [Wireless LAN Report Error Codes](#)
- [Use the Network Connection Repair Tool \(Windows\)](#)
- [I Want to Check that My Network Devices are Working Correctly](#)

I Want to Check that My Network Devices are Working Correctly

Check	Action	Interface
Check that your Brother machine, access point/router, or network hub is turned on.	Check the following: <ul style="list-style-type: none"> The power cord is connected correctly and the Brother machine is turned on. The access point/router or hub is turned on and its link LED is blinking. All protective packaging has been removed from the machine. The toner cartridge and drum unit assembly is installed correctly. The machine's cover is fully closed. Paper is loaded correctly in the paper tray. (For wired networks) A network cable is securely connected to the Brother machine and to the router or hub. 	Wired/Wireless
Check the Link Status on the Network Configuration Report or the Printer Settings page.	Print the Network Configuration Report and check that Ethernet Link Status or Wireless Link Status is Link OK .	Wired/Wireless
Check that you can "ping" the Brother machine from your computer.	Ping the Brother machine from your computer using the IP address or the node name in the Windows command prompt or Mac Terminal application: ping <ipaddress> or <nodename>. <ul style="list-style-type: none"> Successful: Your Brother machine is working correctly and connected to the same network as your computer. Unsuccessful: Your Brother machine is not connected to the same network as your computer. Windows: Ask your administrator about the IP address and the subnet mask, and then use the Network Connection Repair Tool. Mac: Confirm that the IP address and the Subnet Mask are set correctly.	Wired/Wireless
Check that your Brother machine is connected to the wireless network.	Print the WLAN Report to check the error code on the printed report. See <i>Related Information: Print the WLAN Report</i> .	Wireless

If you have checked and tried all of the above but you are still having problems, see the instructions supplied with your wireless access point/router to find the SSID (Network Name) and the Network Key (Password) information and set them correctly.

Related Information

- [Network Problems](#)

Related Topics:

- [Print the Network Configuration Report](#)
- [Print the WLAN Report](#)
- [Wireless LAN Report Error Codes](#)
- [Use the Network Connection Repair Tool \(Windows\)](#)
- [My Machine Cannot Print, Scan, or Use the PC-FAX Receive Function over the Network](#)

AirPrint Problems

Difficulties	Suggestions
My machine is not displayed in the printer list.	Make sure your machine is turned on.
	Make sure your machine and your mobile device or Mac are connected to the same network.
	Move your mobile device closer to the wireless access point/router, or to your machine.
I cannot print.	Make sure your machine is turned on.
	Make sure your machine and your mobile device or Mac are connected to the same network.
I am trying to print a multi-page document from an iOS device, but ONLY the first page is printing.	Make sure you are running the latest OS version.





Related Information

- [Troubleshooting](#)

Related Topics:

- [AirPrint Overview](#)

Other Problems

Difficulties	Suggestions
<p>The machine will not turn on.</p>	<p>Adverse conditions on the power connection (such as lightning or a power surge) may have triggered the machine's internal safety mechanisms. Unplug the power cord. Wait for ten minutes, then plug in the power cord and press  to turn the machine on.</p> <p>If the problem is not solved and you are using a power breaker, disconnect it to make sure it is not the problem. Plug the machine's power cord directly into a different known working wall electrical socket. If there is still no power, try a different power cable.</p>
<p>The machine cannot print EPS data that includes binary with the BR-Script3 printer driver.</p>	<p>(Windows)</p> <p>To print EPS data, do the following:</p> <ol style="list-style-type: none"> Windows 11: <p>Click  > All apps > Windows Tools > Control Panel. In the Hardware and Sound group, click View devices and printers.</p> <p>For Windows 10, Windows Server 2016, Windows Server 2019, and Windows Server 2022:</p> <p>Click  > Windows System > Control Panel. In the Hardware and Sound (Hardware) group, click View devices and printers.</p> <p>For Windows Server 2012:</p> <p>Move your mouse to the lower right corner of your desktop. When the menu bar appears, click Settings > Control Panel. In the Hardware group, click View devices and printers.</p> <p>For Windows Server 2012 R2:</p> <p>Click Control Panel on the Start screen. In the Hardware group, click View devices and printers.</p> Right-click your model's icon with BR-Script3 in the name, select Printer properties. <hr/> <p> If your model with BR-Script3 in the name does not appear, right-click your model's icon, select Printer properties, and then select your model with BR-Script3 in the name.</p> <hr/> <ol style="list-style-type: none"> From the Device Settings tab, choose TBCP (Tagged Binary Communication Protocol) in Output Protocol.
<p>The Brother software cannot be installed.</p>	<p>(Windows)</p> <p>If the Security Software warning appears on the computer screen during the installation, change the Security Software settings to permit the Brother product setup program or other program to run.</p> <p>(Mac)</p> <p>If you are using a firewall function of anti-spyware or antivirus security software, temporarily disable it and then install the Brother software.</p>

Copying difficulties

Difficulties	Suggestions
Cannot make a copy.	Make sure you pressed Copy and the machine is in Copy mode. Contact your administrator to check your Secure Function Lock settings.
Vertical black line appears in copies.	Black vertical lines on copies are typically caused by dirt or correction fluid on the glass strip, or the corona wire is dirty. Clean the glass strip and scanner glass and the white bar and white plastic above them.
Copies are blank.	Make sure you are loading the document correctly.

Scanning difficulties

Difficulties	Suggestions
TWAIN or WIA errors appear when starting to scan. (Windows)	Make sure the Brother TWAIN or WIA driver is selected as the primary source in your scanning application. For example, in Nuance™ PaperPort™ 14SE, click Desktop > Scan Settings > Select to select the Brother TWAIN/WIA driver.
OCR does not work.	Try increasing the scanning resolution.
Cannot scan.	Contact your administrator to check your Secure Function Lock settings.

Software difficulties

Difficulties	Suggestions
Cannot install software or print.	(Windows) Run the install program again. This program will repair and reinstall the software.



Related Information

- [Troubleshooting](#)

Check the Machine Information

Follow these instructions to check your machine's serial number and firmware version.

1. Press  [Settings] > [All Settings] > [Machine Info.].
2. Press one of the following options:

Option	Description
Serial No.	Check your machine's serial number.
Firmware Version	Check your machine's firmware version.
Firmware Update	Update your machine to the latest firmware.
Firmware Auto Check	View firmware information on the Main Home screen.
Page Counter	Check the total number of pages the machine has printed.
Parts Life	Check the percentage of the supplies' life that remains available.

3. Press .

Related Information

- [Troubleshooting](#)

Reset Your Machine

1. Press  [Settings] > [All Settings] > [Initial Setup] > [Reset].
2. Press the reset function you want to use.



- The network settings, the security settings and address book data will not be reset by the [Machine Reset].
- If you discard or dispose the machine, we recommend performing a [Factory Reset] to erase the personal data in the machine.

3. [Machine will reboot after resetting. Press [OK] for 2 seconds to confirm.] appears. Press [OK] for two seconds to confirm.



You can also reset the network settings by pressing  [Settings] > [All Settings] > [Network] > [Network Reset].

The machine will restart.



Related Information

- [Troubleshooting](#)
 - [Reset Functions Overview](#)

Related Topics:

- [Reset the Network Settings to the Factory Settings](#)

Reset Functions Overview

The following reset functions are available:



Unplug the interface cable before you choose Network Settings Reset function, All Settings Reset function or Factory Reset function.

1. Machine Reset

Reset all the machine's settings that you have changed, such as Date and Time and Ring Delay.

The Address Book, fax reports, and Call history will remain. (For models with facsimile function)

2. Network Settings Reset (For Network Models)

Reset the print server back to its default factory settings (includes Password and IP Address information).

3. Address Book and Fax Settings Reset

This function resets the following settings:



The following settings, with the exception of the Address Book and the Setting Lock password, apply to models with facsimile function.

- Address Book
(Addresses and Groups)
- Programmed fax jobs in the memory
(Delayed Fax)
- Station ID
(name and number)
- Fax receive settings
(PC-Fax Receive (Windows only))
- Report
- Setting Lock password (available models only)

4. All Settings Reset

Reset all the machine's settings back to the settings that were set at the factory.

All Settings Reset takes less time than Factory Reset.

5. Factory Reset

Use the Settings Reset function to reset all of the machine's settings to the settings originally set at the factory.

Factory Reset takes more time than All Settings Reset.

We strongly recommend you perform this operation when you dispose of the machine.



Related Information

- [Reset Your Machine](#)
-

Routine Maintenance

- [Replace Supplies](#)
- [Clean the Machine](#)
- [Check the Remaining Part Life](#)
- [Pack the Machine and the Toner Cartridge Together](#)
- [Replace Periodic Maintenance Parts](#)

Replace Supplies

You must replace supplies when the machine indicates that the life of the supply is over.

IMPORTANT

To avoid print quality problems, DO NOT touch the shaded parts shown in the illustrations.

Toner Cartridge

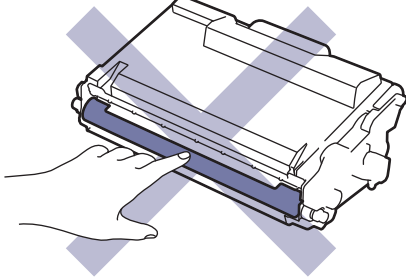

Drum Unit

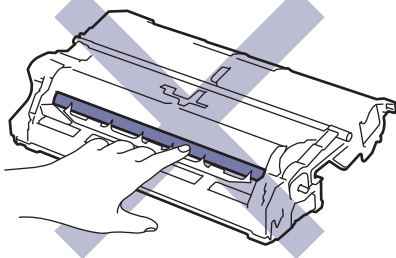
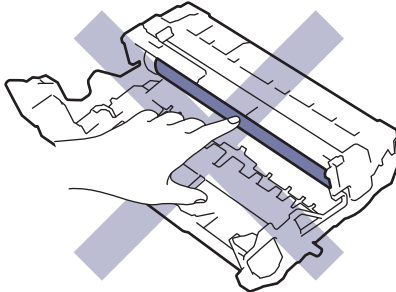

NOTE

- Be sure to seal the used supplies tightly in a bag so that toner powder does not spill out of the cartridge.
- Discard used consumable items according to local regulations, keeping it separate from domestic waste. If you have questions, call your local waste disposal office. Be sure to reseal the consumable items tightly so that the material inside does not spill.
- We recommend placing both the new and the used supplies on a piece of paper to prevent accidentally spilling or scattering the contents.
- Using paper that is not a direct equivalent for a recommended print media may reduce the life of supplies and machine parts.
- The projected life for each of the toner cartridges is based on ISO/IEC 19752. Frequency of replacement will vary depending on the print volume, percentage of coverage, types of media used, and powering on/off the machine.
- Frequency of replacing supplies except toner cartridges will vary depending on the print volume, types of media used, and powering on/off the machine.
- Handle the toner cartridge carefully. If toner scatters on your hands or clothes, immediately wipe or wash it off with cold water.



Both the toner cartridge and the drum unit feature an Integrated Circuit (IC) chip. DO NOT touch these surfaces. Touching the IC chips may cause contamination or damage, and may interfere with the machine's ability to detect these components.

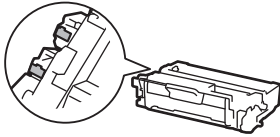

Related Information

- [Routine Maintenance](#)
 - [Replace the Toner Cartridge](#)
 - [Replace the Drum Unit](#)

Related Topics:

- [Error and Maintenance Messages](#)
-

Replace the Toner Cartridge

1. Make sure the machine is turned on.
2. Open the front cover.

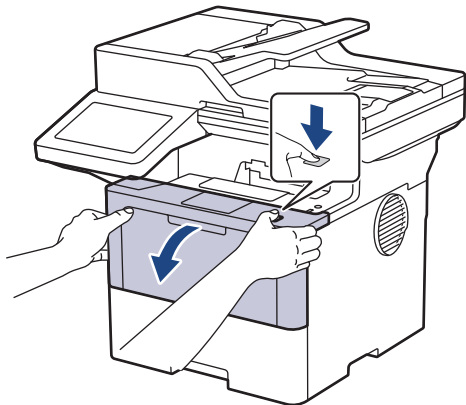

3. Remove the toner cartridge and drum unit assembly from the machine.

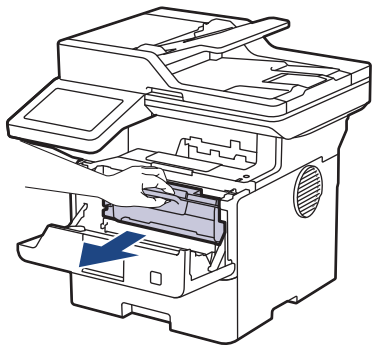

4. Push down the green lock lever and take the toner cartridge out of the drum unit.

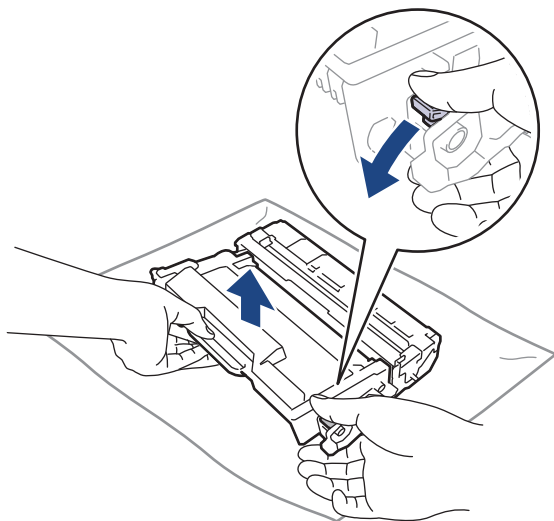

5. Unpack the new toner cartridge.

6. Remove the protective cover.

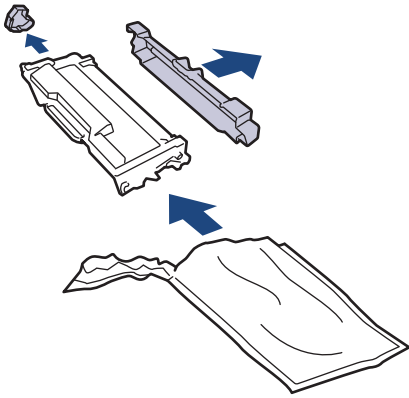

7. Hold the toner cartridge by the handle and shake it from left to right several times, as shown. Then push it firmly into the drum unit until it locks into place.

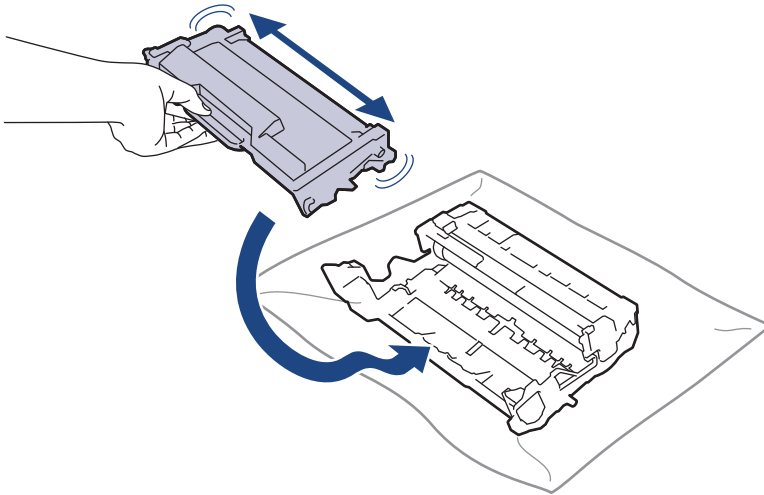

Make sure you put the toner cartridge in correctly or it may separate from the drum unit.
If you put it in properly, the green lock lever will lift automatically.

8. Clean the corona wire inside the drum unit by gently sliding the green tab from left to right and right to left several times.

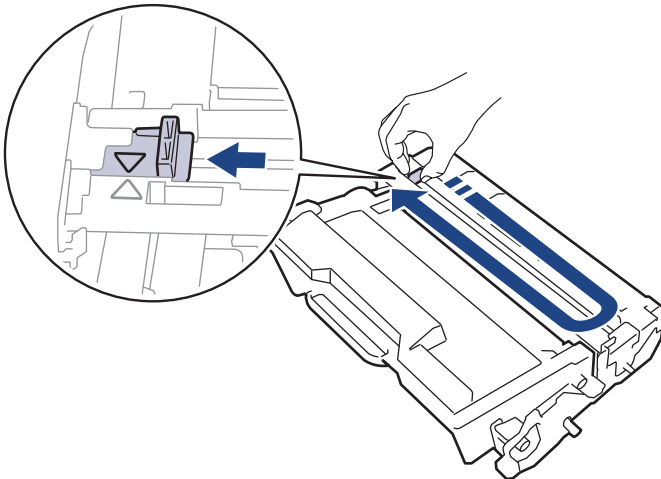

Be sure to return the tab to the Home position (▲). The arrow on the tab must be aligned with the arrow on the drum unit. If it is not, printed pages may have a vertical stripe.

9. Reinsert the toner cartridge and drum unit assembly back into the machine.

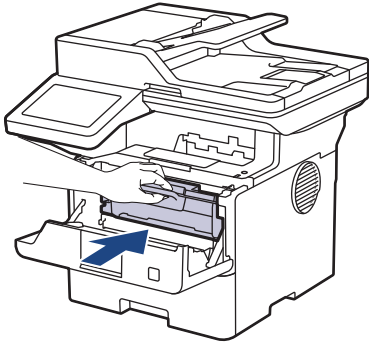

10. Close the front cover of the machine.



-
- After replacing a toner cartridge, **DO NOT** turn the machine off or open the front cover until the machine's display returns to Ready Mode.
 - The toner cartridge that comes with your Brother machine is an Inbox toner cartridge.
 - It is a good idea to keep a new toner cartridge ready for use when you see the Toner Low warning.
 - **DO NOT** unpack the new toner cartridge until you are ready to install it.
 - If a toner cartridge is left unpacked for a long time, the toner life will be shortened.
 - We recommend using genuine Brother supplies to ensure stable print quality and performance. Although not all non-genuine supplies may cause quality issues, it is possible that some may adversely affect print quality or cause machine malfunction. Brother may charge for repairing your machine if it is proven that non-genuine supplies caused the damage, even if the machine is still covered by the warranty.
-



Related Information

- [Replace Supplies](#)

Related Topics:

- [Error and Maintenance Messages](#)
 - [Improve the Print Quality](#)
-

Replace the Drum Unit

1. Make sure the machine is turned on.
2. Open the front cover.

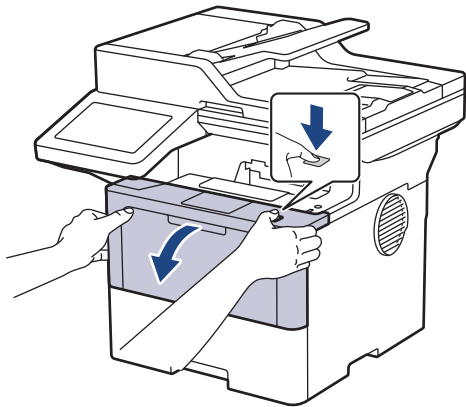

3. Remove the toner cartridge and drum unit assembly from the machine.

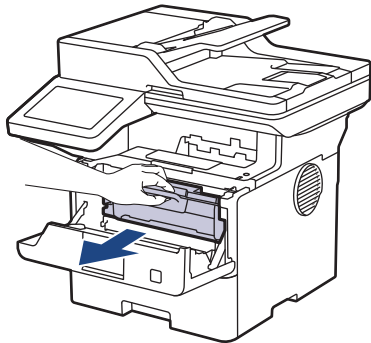

4. Push down the green lock lever and take the toner cartridge out of the drum unit.

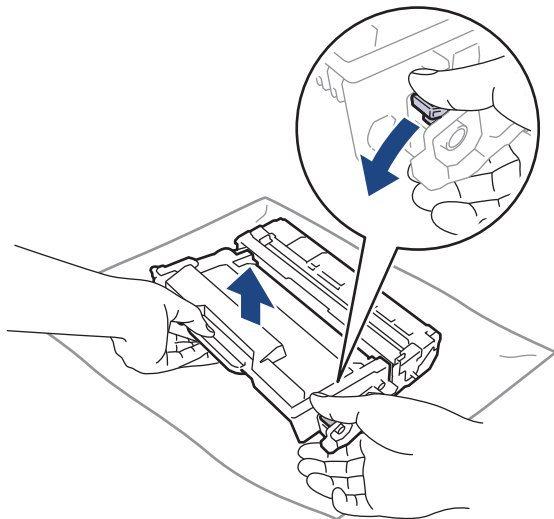

5. Unpack the new drum unit.

6. Remove the protective cover.

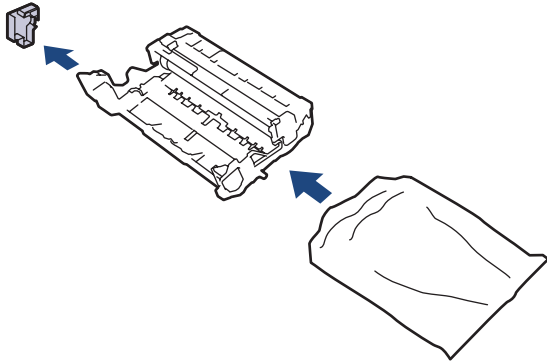

7. Push the toner cartridge firmly into the new drum unit until it locks into place.

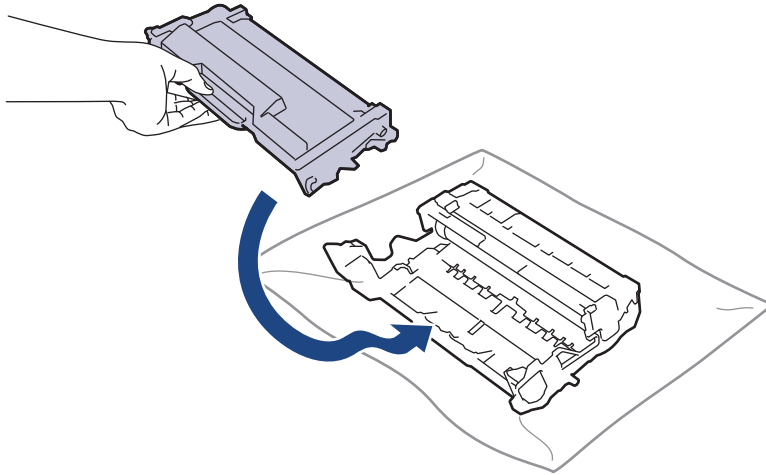

Make sure you put the toner cartridge in correctly or it may separate from the drum unit. If you put it in properly, the green lock lever will lift automatically.

8. Reinsert the toner cartridge and drum unit assembly back into the machine.

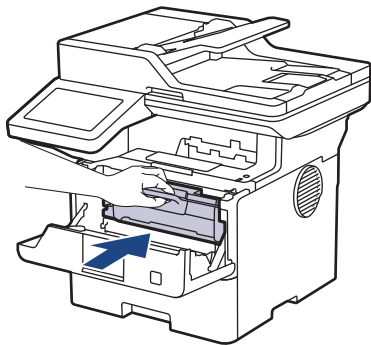

9. Close the front cover of the machine.

NOTE

- Drum wear and tear occurs due to use and rotation of the drum and interaction with paper, toner, and other materials in the paper path. In designing this product, Brother decided to use the number of rotations of the drum as a reasonable determinant of the drum life. When a drum reaches the factory-established rotation limit corresponding to the rated page yield, the product's LCD will advise you to replace the drum. The product will continue to function; however, print quality may not be optimal.
- If an unpacked drum unit is placed in direct sunlight (or room light for long periods of time), the unit may be damaged.
- There are many factors that determine the actual drum life, such as the temperature, humidity, type of paper, type of toner used and so on. Under ideal conditions, the average drum life is estimated at approximately 75,000 pages based on three pages per job and 45,000 pages based on one page per job (A4/Letter single-sided pages). The number of pages may be affected by a variety of factors including, but not limited to, media type and media size.

Because we have no control over the many factors that determine the actual drum life, we cannot guarantee a minimum number of pages that will be printed by your drum.

- The machine should be used only in a clean, dust-free environment with adequate ventilation.

We recommend using genuine Brother supplies to ensure stable print quality and performance. Although not all non-genuine supplies may cause quality issues, it is possible that some may adversely affect print quality or cause machine malfunction. Brother may charge for repairing your machine if it is proven that non-genuine supplies caused the damage, even if the machine is still covered by the warranty.



Related Information

- [Replace Supplies](#)

Related Topics:

- [Error and Maintenance Messages](#)
 - [Improve the Print Quality](#)
-

Clean the Machine

Clean the outside and inside of the machine regularly with a dry, lint-free cloth.

When you replace the toner cartridge or the drum unit, make sure you clean the inside of the machine. If printed pages are stained with toner, clean the inside of the machine with a dry, lint-free cloth.

WARNING

DO NOT use flammable substances, any type of spray, or an organic solvent/liquid containing alcohol or ammonia to clean the inside or outside of the product. Doing so could cause a fire. Instead, use only a dry, lint-free cloth.



IMPORTANT

- DO NOT use isopropyl alcohol to remove dirt from the control panel. It may crack the panel.
- To avoid print quality problems, DO NOT touch the shaded parts shown in the illustrations.

Toner cartridge

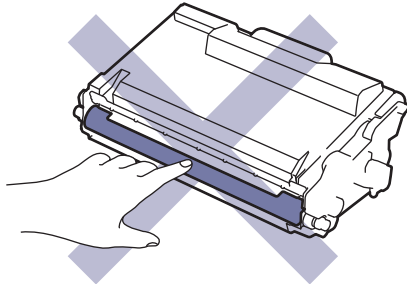

Drum unit

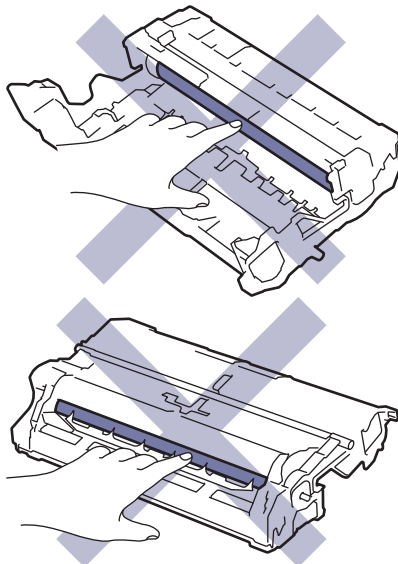



Both the toner cartridge and the drum unit feature an IC chip. DO NOT touch these surfaces. Touching the IC chips may cause contamination or damage, and may interfere with the machine's ability to detect these parts.

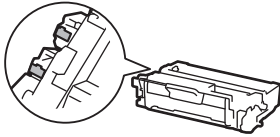

Related Information

- Routine Maintenance
 - Clean the Scanner
 - Clean the Touchscreen LCD
 - Clean the Corona Wire
 - Clean the Drum Unit
 - Clean the Paper Pick-up Rollers
-

Clean the Scanner

Before starting the cleaning procedure, see *Related Information: Clean the Machine*.

1. Press and hold  to turn the machine off.
2. Lift the document cover (1). Clean the white plastic surface (2) and scanner glass (3) underneath it with a soft lint-free cloth moistened with water.

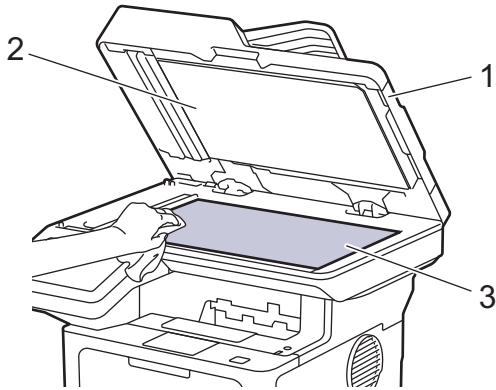

3. In the ADF unit, clean the white bar (1) and the scanner glass strip (2) underneath it with a soft lint-free cloth moistened with water.

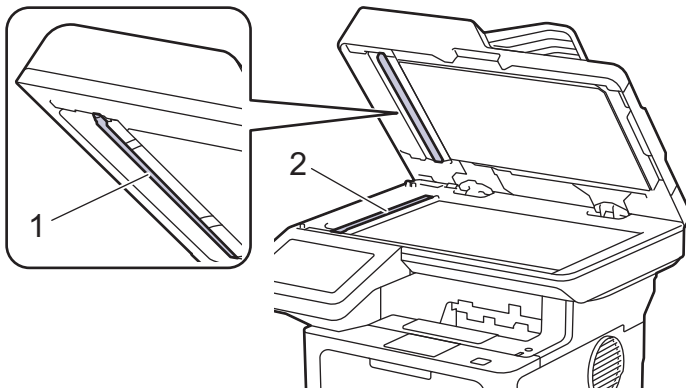

4. (For automatic 2-sided scanning models) Open the scanner glass cover (1), and then clean the other white bar (2) and scanner glass strip (3).

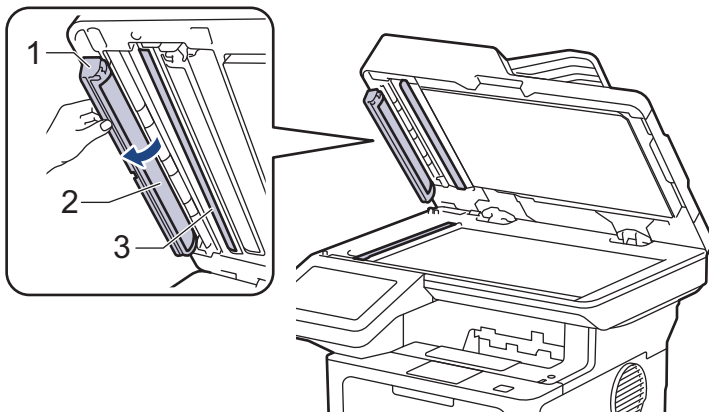

5. Close the document cover.
6. Press  to turn the machine on.

Related Information

- [Clean the Machine](#)

Related Topics:

- [Improve the Print Quality](#)
-

Clean the Touchscreen LCD

Before starting the cleaning procedure, see *Related Information: Clean the Machine*.

IMPORTANT

DO NOT use any type of liquid cleaners (including ethanol).

1. Press and hold  to turn the machine off.
2. Clean the touchscreen with a dry, soft lint-free cloth.

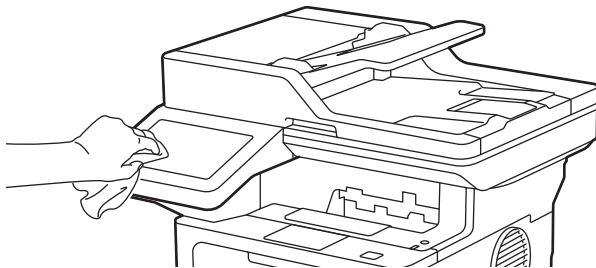

3. Press  to turn the machine on.

Related Information

- [Clean the Machine](#)

Clean the Corona Wire

If you have print quality problems or the control panel displays [Drum !] status, clean the corona wire.

1. Open the front cover.

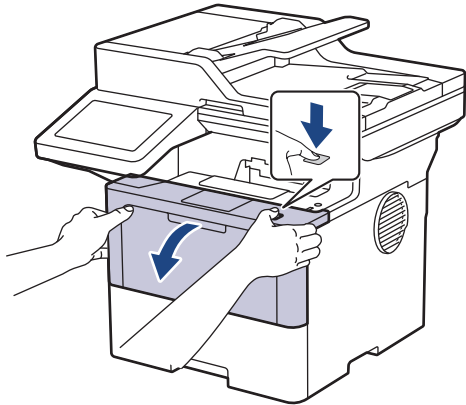

2. Remove the toner cartridge and drum unit assembly from the machine.

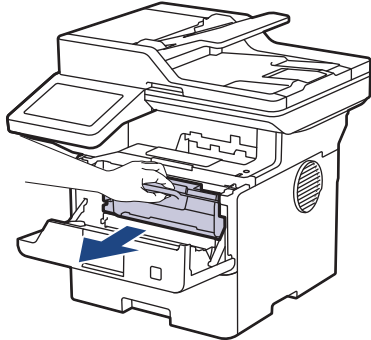

3. Clean the corona wire inside the drum unit by gently sliding the green tab from left to right and right to left several times.

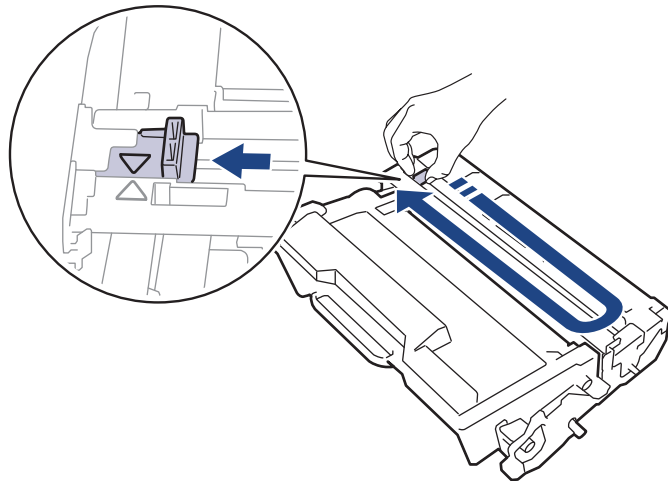

Be sure to return the tab to the Home position (▲). The arrow on the tab must be aligned with the arrow on the drum unit. If it is not, printed pages may have a vertical stripe.

-
4. Reinsert the toner cartridge and drum unit assembly back into the machine.

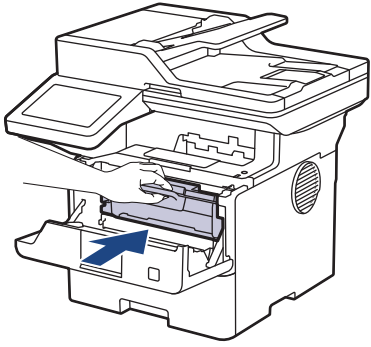

5. Close the front cover of the machine.



Related Information



- [Clean the Machine](#)

Related Topics:

- [Error and Maintenance Messages](#)
-

Clean the Drum Unit

If your printout has dots or other repeating marks at 94 mm intervals, the drum may have foreign material, such as glue from a label, stuck on the drum surface.

1. Make sure the machine is in Ready mode.
2. Press  [Settings] > [All Settings] > [Print Reports] > [Drum Dot Print].
3. Press [Yes].
The machine prints the Drum Dot Check Sheet.
4. Press .
5. Press and hold  to turn the machine off.
6. Open the front cover.

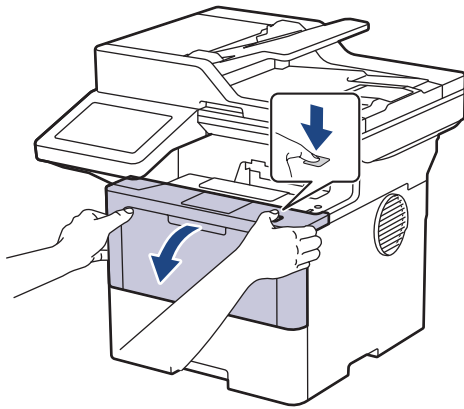

7. Remove the toner cartridge and drum unit assembly from the machine.

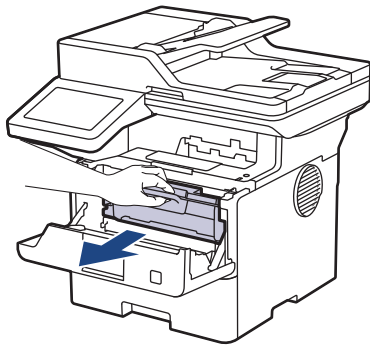

8. Push down the green lock lever and take the toner cartridge out of the drum unit.

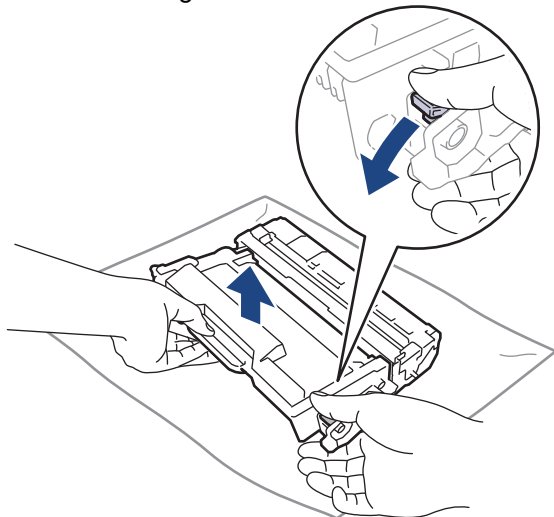

9. Turn the drum unit as shown in the illustration. Make sure that the drum unit gear (1) is on the left side.

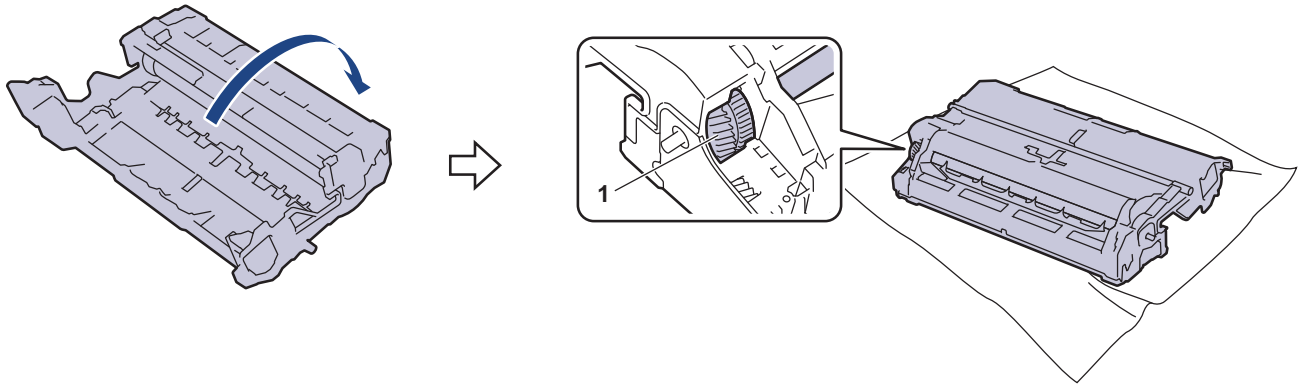

10. Use the numbered markers next to the drum roller to find the mark on the drum. For example, a dot in column 2 on the check sheet means that there is a mark in drum region "2".

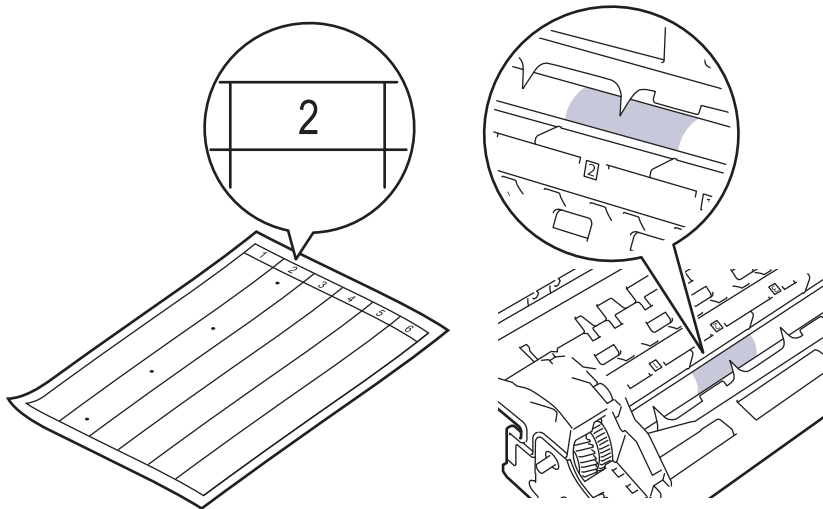

11. Turn the drum unit edge towards you while looking at the drum surface to find the mark.

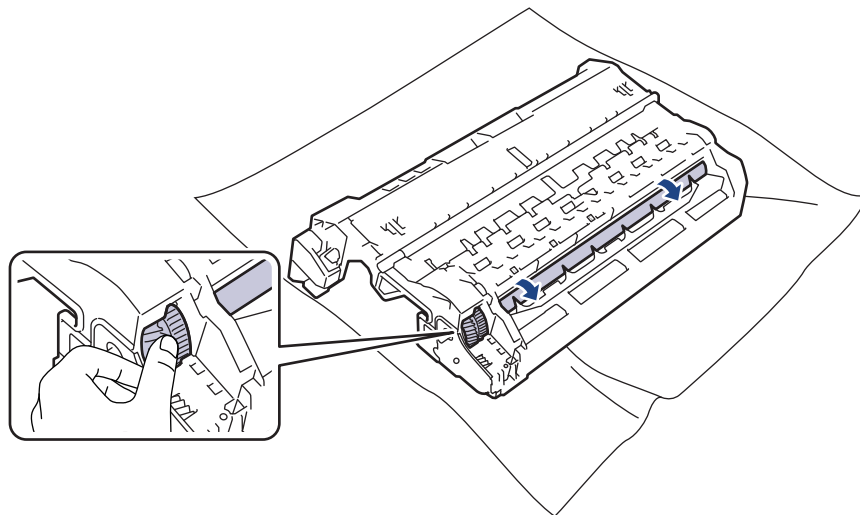

IMPORTANT

To avoid print quality problems, DO NOT touch the surface of the drum unit, only the edge.

12. Wipe the drum unit surface gently with a dry cotton swab until the mark or foreign material on the surface comes off.

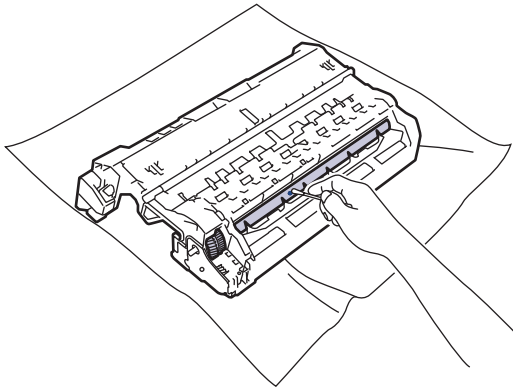

NOTE

DO NOT clean the surface of the photosensitive drum with a sharp object or any liquids.

13. Push the toner cartridge firmly into the drum unit it locks into place.

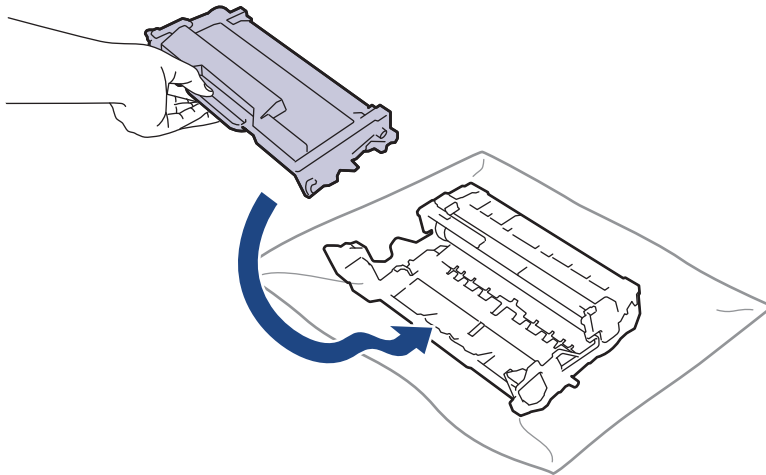

Make sure you put the toner cartridge in correctly or it may separate from the drum unit. If you put it in properly, the green lock lever will lift automatically.

14. Reinsert the toner cartridge and drum unit assembly back into the machine.

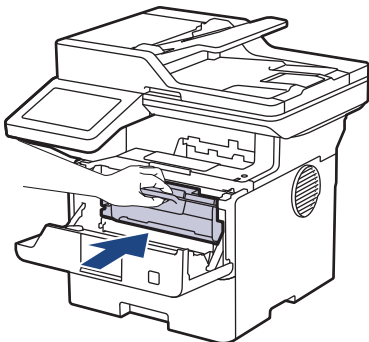

15. Close the front cover of the machine.

16. Press  to turn the machine on.



Related Information

- [Clean the Machine](#)

Related Topics:

- [Improve the Print Quality](#)
-

Clean the Paper Pick-up Rollers

Cleaning the paper pick-up rollers periodically may prevent paper jams by ensuring that paper feeds correctly.

Before starting the cleaning procedure, see *Related Information: Clean the Machine*.

If you have paper feed problems, clean the pick-up rollers as follows:

1. Press and hold  to turn the machine off.
2. Pull the paper tray completely out of the machine.

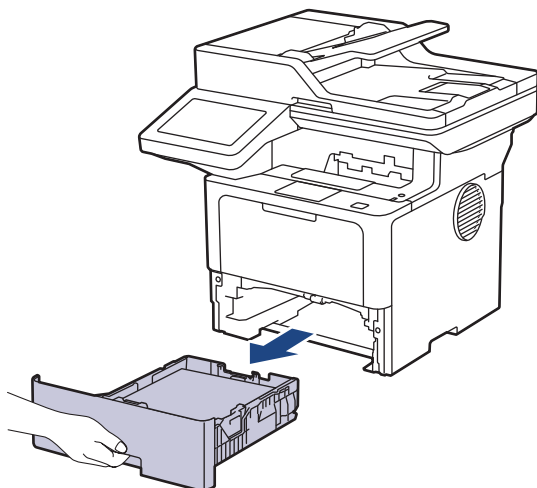

3. If paper is loaded or something is stuck inside in the paper tray, remove it.
4. Tightly wring out a lint-free cloth soaked in lukewarm water, and then wipe the separator pad on the paper tray to remove dust.

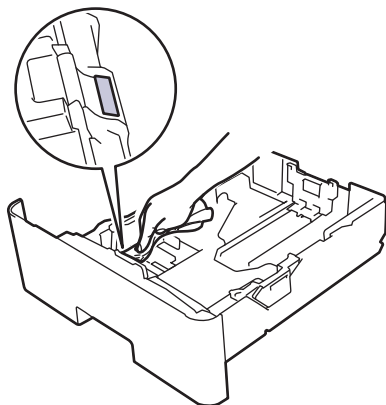

5. Wipe the two pick-up rollers inside the machine to remove dust.

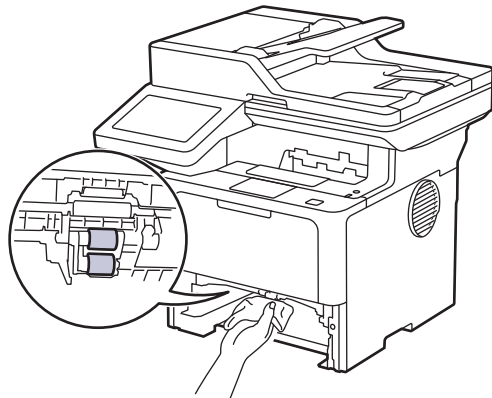

6. Reload the paper and put the paper tray firmly back in the machine.
7. Press  to turn the machine on.





Related Information

- [Clean the Machine](#)

Related Topics:

- [Printing Problems](#)
-

Check the Remaining Part Life

1. Press  [Settings] > [All Settings] > [Machine Info.] > [Parts Life].
2. Press the machine part you want to check.
The LCD displays the approximate remaining part life.
3. Press .



To display the approximate remaining life of the toner cartridge, press  on the LCD.



Related Information

- [Routine Maintenance](#)

Pack the Machine and the Toner Cartridge Together

WARNING

- When you move the machine, carry the machine as shown in the illustration.

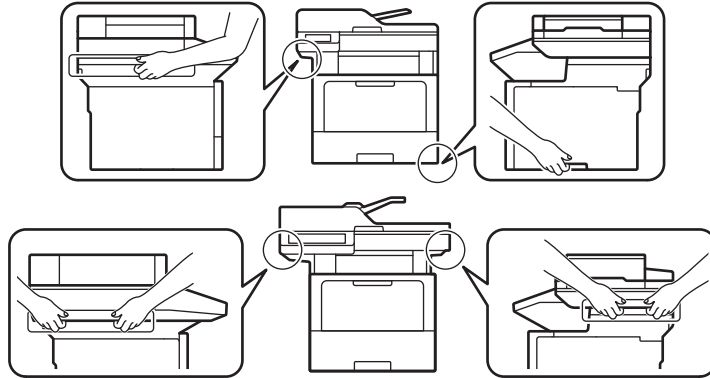

- To prevent possible injuries, at least two people should lift the product by holding it at the front and back.

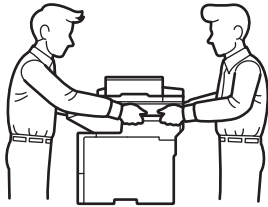

- If the machine has Optional Tray(s) installed, remove the Optional Tray(s) BEFORE moving the machine. Attempting to move the machine without removing the Optional Tray(s) may cause injury to you or damage to the machine.
- Pack the Optional Tray(s) separately in the original carton with original packing material.



If for any reason you must ship your machine, carefully repack the machine in the original packaging to avoid any damage during transit. The machine should be adequately insured with the carrier.

- Press and hold  to turn the machine off. Leave the machine off for at least 10 minutes to cool down.
- Disconnect all the cables, and then unplug the power cord from the electrical socket.
- Put the machine into the bag it originally came in.

- Pack the machine, the printed materials, and the AC power cord (if applicable) in the original carton with the original packing material as shown. (The original packing material may differ depending on your model.)

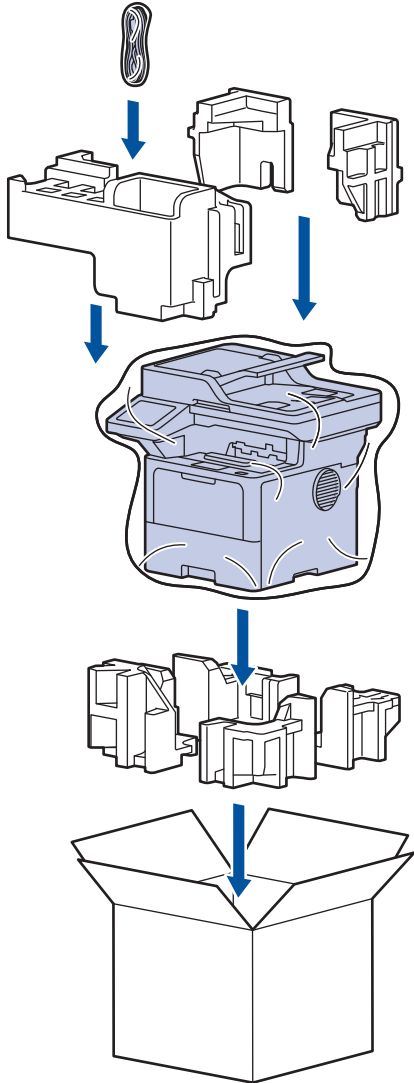

- Close the carton and tape it shut.
- If you have a Lower Tray, repack it as shown.

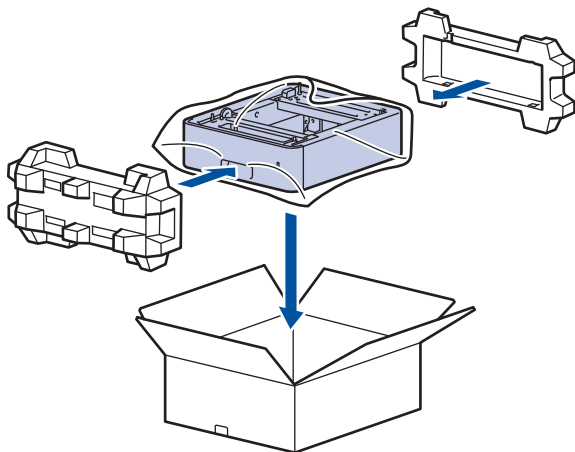

✓ Related Information

- [Routine Maintenance](#)

Replace Periodic Maintenance Parts

Replace the following parts regularly to maintain the best print quality. The parts listed below must be replaced after printing approximately 50,000 pages ¹ for the Paper Feeding Kits of the MP tray and approximately 200,000 pages ¹ for the Paper Feeding Kits of the standard paper tray, the Paper Feeding Kits of the optional paper tray, Fuser Unit, and Laser Unit.

Contact Brother customer service or your local Brother dealer when the following messages appear on the LCD:

LCD Message	Description
Maintenance Replace Fuser ²	Replace the Fuser Unit.
Maintenance Replace Laser ²	Replace the Laser Unit.
Maintenance Replace PF Kit 1 ^{2 3}	Replace the Paper Feeding Kit for the Standard Paper Tray.
Maintenance Replace PF Kit 2 ^{2 3 4}	Replace the Paper Feeding Kit for the Optional Tray.
Maintenance Replace PF Kit MP ^{2 3}	Replace the Paper Feeding Kit for the Multi-purpose (MP) Tray.



Related Information

- [Routine Maintenance](#)

¹ Letter or A4 size 1-sided pages.

² The replacement frequency depends on the complexity of printed pages, percentage of coverage, and the type of media used.

³ The kit includes the roller holder assembly, separation pad, and separation pad spring for the paper tray or MP Tray.

⁴ If you use the Optional Tray(s) with your machine, this message will appear on the LCD. When the machine has multiple Optional Trays, the machine displays messages using numbers corresponding to each Optional Tray.

Machine Settings

Customise settings and features to make your machine a more efficient work tool.

- [Change Machine Settings from the Control Panel](#)
- [Change Machine Settings Using Web Based Management](#)

Change Machine Settings from the Control Panel

- [In the Event of Power Failure \(Memory Storage\)](#)
- [General Settings](#)
- [Save Your Favourite Settings as a Shortcut](#)
- [Print Reports](#)
- [Settings and Features Tables](#)

In the Event of Power Failure (Memory Storage)

Your menu settings are stored permanently, and in the event of a power failure will not be lost. Temporary settings (for example, Contrast, Overseas Mode) are lost.

During a power failure, the machine will retain the date and time and programmed fax timer jobs (for example, Delayed Fax) for approximately 60 hours. Other fax jobs in the machine's memory will not be lost.



Related Information

- [Change Machine Settings from the Control Panel](#)
-

General Settings

- [Adjust the Machine's Volume](#)
- [Set Sleep Mode Countdown](#)
- [About Deep Sleep Mode](#)
- [Set Auto Power Off Mode](#)
- [Set the Date and Time](#)
- [Set the Time Zone](#)
- [Adjust the LCD Backlight Brightness](#)
- [Change How Long the LCD Backlight Stays On](#)
- [Set Your Station ID](#)
- [Set Tone or Pulse Dialling Mode](#)
- [Reduce Toner Consumption](#)
- [Add a Prefix to Every Fax Number](#)
- [Prevent Dialling a Wrong Number \(Dial Restriction\)](#)
- [Reduce Printing Noise](#)
- [Improve Print Output](#)
- [Change the Language on the LCD](#)

Adjust the Machine's Volume

1. Do one of the following:

- For MFC models:

Press  [Settings] > [All Settings] > [General Setup] > [Volume].

- For DCP models:

Press  [Settings] > [All Settings] > [General Setup] > [Beep].

2. Press one of the following options (MFC models):

(The options will vary depending on your machine.)

- [Ring]

Adjust the ring volume.

- [Beep]

Adjust the volume of the beep you hear when you press a button, make a mistake, or after you send or receive a fax.

- [Speaker]

Adjust the speaker volume.

3. Select the [Off], [Low], [Med] or [High] option, and then press the option you want.

4. Press .





Related Information

- [General Settings](#)

Set Sleep Mode Countdown

The Sleep Mode (or Power Save Mode) setting can reduce power consumption. When the machine is in Sleep Mode, it acts as though it is turned off. The machine will wake up and start printing when it receives a print job or a fax. Use these instructions to set a time delay (countdown) before the machine enters Sleep Mode.

- You can choose how long the machine must be idle before it goes into Sleep Mode.
- The timer will restart if any operation is carried out on the machine, such as receiving a print job.

1. Press  [Settings] > [All Settings] > [General Setup] > [Ecology] > [Sleep Time].
2. Enter the length of time (maximum 50 minutes) the machine will remain idle before entering Sleep Mode, and then press [OK].
3. Press .

Related Information

- [General Settings](#)

About Deep Sleep Mode

If the machine is in Sleep Mode and does not receive any jobs for a certain length of time, the machine will automatically enter Deep Sleep Mode. The length of time is based on your specific model and settings.

Deep Sleep Mode uses less power than Sleep Mode.

Applicable Models	Machine's LCD in Deep Sleep Mode	Conditions That Will Wake the Machine
DCP-L5518DN/MFC-L5718DN/ MFC-L5728DW	The LCD backlight turns off and the Power LED blinks.	<ul style="list-style-type: none">The machine receives a job.Someone presses  or the touchscreen LCD.





Related Information

- [General Settings](#)

Set Auto Power Off Mode

If the machine is in Deep Sleep Mode for certain length of time, based on your model and settings, the machine will go into Power Off Mode automatically. The machine does not go into Power Off Mode when the machine is connected to a network or a telephone line, or has secure print data in the memory(available for certain models).

To start printing, press  on the control panel and then send a print job.



1. Press  [Settings] > [All Settings] > [General Setup] > [Ecology] > [Auto Power Off].
2. Press the [Off], [1hour], [2hours], [4hours] or [8hours] option you want.
3. Press .



Related Information

- [General Settings](#)

Set the Date and Time

1. Press  [Settings] > [All Settings] > [Initial Setup] > [Date & Time] > [Date].
2. Enter the last two digits of the year using the LCD, and then press [OK].
3. Enter the two digits for the month using the LCD, and then press [OK].
4. Enter the two digits for the day using the LCD, and then press [OK].
5. Press [Clock Type].
6. Press [12h Clock] or [24h Clock].
7. Press [Time].
8. To enter the time, do one of the following:
 - If you selected [12h Clock] as the format in the [Clock Type] setting, enter the time (in 12-hour format) using the LCD.
Press  to select [AM] or [PM].
Press [OK].
 - If you selected [24h Clock] as the format in the [Clock Type] setting, enter the time (in 24-hour format) using the LCD.
Press [OK].
(For example: enter 19:45 for 7:45 PM.)
9. Press .





Related Information

- [General Settings](#)

Set the Time Zone

Set the time zone for your location on the machine.

1. Press  [Settings] > [All Settings] > [Initial Setup] > [Date & Time] > [Time Zone].
2. Enter your time zone.
3. Press [OK].
4. Press .





Related Information

- [General Settings](#)
-

Adjust the LCD Backlight Brightness

If you are having difficulty reading the LCD, changing the brightness setting may help.

1. Press  [Settings] > [All Settings] > [General Setup] > [LCD Settings] > [Backlight].
2. Press the [Light], [Med] or [Dark] option.
3. Press .



Related Information

- [General Settings](#)
-

Change How Long the LCD Backlight Stays On

Set how long the LCD backlight stays on.

1. Press  [Settings] > [All Settings] > [General Setup] > [LCD Settings] > [Dim Timer].



If your machine displays the [All Settings] menu on the Home screen, skip the [Settings] menu.

2. Press the [10Secs], [20Secs] or [30Secs] option.
3. Press .



Related Information

- [General Settings](#)



Set Your Station ID

Related Models: MFC-L5718DN/MFC-L5728DW

Set the machine to print your Station ID and the fax's date and time at the top of each fax you send.

1. Press  [Settings] > [All Settings] > [Initial Setup] > [Station ID] > [Fax].
2. Enter your fax number (up to 20 digits) using the LCD, and then press [OK].
3. Press [Tel].
4. Enter your telephone number (up to 20 digits) using the LCD, and then press [OK].
5. Press [Name].
6. Enter your name (up to 20 characters) using the LCD, and then press [OK].



- Press  to cycle between letters, numbers and special characters. (The characters available may differ depending on your country.)
- If you enter an incorrect character, press ◀ or ▶ to move the cursor to it and press . Press the correct character.
- To enter a space, press [Space] or ▶.
- For more detailed information, see *Related Information*.

7. Press .



Related Information

- [General Settings](#)

Related Topics:



- [How to Enter Text on Your Machine](#)
- [Transfer Faxes to Another Fax Machine](#)
- [Transfer the Fax Journal Report to Another Fax Machine](#)

Set Tone or Pulse Dialling Mode

Related Models: MFC-L5718DN/MFC-L5728DW

Your machine is set for a Tone dialling service. If you have a Pulse dialling (rotary) service, you must change the dialling mode.

This feature is not available in some countries.

1. Press  [Settings] > [All Settings] > [Initial Setup] > [Tone/Pulse].
2. Press [Tone] or [Pulse].
3. Press .



Related Information

- [General Settings](#)

Reduce Toner Consumption

Using the Toner Save feature may reduce toner consumption. When Toner Save is set to on, the print on your documents appears lighter.

We DO NOT recommend using the Toner Save feature for printing photo or greyscale images.

1. Press  [Settings] > [All Settings] > [General Setup] > [Ecology] > [Toner Save].
2. Press [On] or [Off].
3. Press .

Related Information

- [General Settings](#)

Related Topics:

- [Improve the Print Quality](#)

Add a Prefix to Every Fax Number

Related Models: MFC-L5718DN/MFC-L5728DW

The Dial Prefix setting will automatically dial a predefined number before every fax number you dial. For example: If your telephone system requires a 9 to dial an outside number, use this setting to automatically dial 9 for every fax you send.



- Use the numbers and symbols from 0 to 9, #, and *. (You cannot use ! with any other numbers or symbols.)
- If your telephone system requires a time break recall (hookflash), press ! on the LCD.

1. Press  [Settings] > [All Settings] > [Initial Setup] > [Dial Prefix].
2. Press [On] or [Off].

Option	Description
On	To activate the prefix number setting, select On. If you selected On, go to the next step to set a prefix number.
Off	To deactivate the prefix number setting, select Off. If you selected Off, press  to exit.

3. Press [Dial Prefix].
4. Enter a prefix number (up to five digits) using the LCD, and then press [OK].



To change the prefix number, press ◀ or ▶ to position the cursor under the digit to be deleted and press . Then press the correct digit.
Repeat until the prefix number is correct, and then press [OK].

5. Press .

✓ Related Information

- [General Settings](#)

Prevent Dialling a Wrong Number (Dial Restriction)

Related Models: MFC-L5718DN/MFC-L5728DW

This feature prevents users from sending a fax or call to the wrong number by mistake. You can set the machine to restrict dialling when you use the dial pad, Address Book, Shortcuts and LDAP search.

1. Press  [Settings] > [All Settings] > [Fax] > [Dial Restriction].
2. Press one of the following options:
 - [Dial Pad]
 - [Address Book]



If you combine Address Book numbers when dialling, the numbers will be recognised as dial pad input and will not be restricted.

- [Shortcuts]
 - [LDAP Server]
3. Press one of the following options:

Option	Description
Enter # Twice	The machine prompts you to re-enter the number, and then if you re-enter the same number correctly, the machine will start dialling. If you re-enter the wrong number, the LCD will display an error message.
On	The machine restricts all fax sending and outbound calls for that dialling method.
Off	The machine does not restrict the dialling method.



- The [Enter # Twice] setting will not work if you use an external phone or press [Hook] before entering the number. You will not be asked to re-enter the number.
- If you choose [On] or [Enter # Twice], you cannot use the Broadcasting feature.

4. Press .





Related Information

- [General Settings](#)

Reduce Printing Noise

The Quiet Mode setting can reduce printing noise. When Quiet Mode is turned on, the print speed becomes slower. The factory setting is off.

1. Press  [Settings] > [All Settings] > [General Setup] > [Ecology] > [Quiet Mode].
2. Press [On] or [Off].
3. Press .





Related Information

- [General Settings](#)

Improve Print Output

If the printout is curled or the toner does not fix well, you can improve the print output.

1. Press  [Settings] > [All Settings] > [General Setup] > [Improve Output].
2. Press [Off], [Reduce Curl], or [Toner Fixing].
3. Press .





Related Information

- [General Settings](#)
-

Change the Language on the LCD

Change the LCD language if needed.

This feature is not available in some countries.

1. Press  [Settings] > [All Settings] > [Initial Setup] > [Local Language].
2. Press your language.
3. Press .

Related Information

- [General Settings](#)
-





Save Your Favourite Settings as a Shortcut

- [Add Shortcuts](#)
- [Change or Delete Shortcuts](#)

Add Shortcuts

You can add the Fax, Copy, or Scan settings you use most frequently by saving them as your Shortcuts. Later you can press the Shortcut to apply these settings instead of manually re-entering them.

These instructions describe how to add a Copy Shortcut. The steps for adding a Fax or Scan Shortcut are very similar.



1. Press  [Shortcuts]. (If  [Shortcuts] is displayed.)
2. Press a tab.
3. Press any  to add a new Shortcut.
4. Press [Copy].
5. Press the copy preset you want.
6. Press  [Options].
7. Swipe up or down or press ▲ or ▼ to display the available settings, and then press the setting you want to change.
8. Swipe up or down or press ▲ or ▼ to display the available options for the setting, and then press the option you want.
Repeat these two steps until you have selected all the settings and options you want.
9. When you have finished changing settings, press [OK]. (If the [OK] button is displayed.)
10. Press [OK].
11. Read and confirm the displayed list of settings you have selected, and then press [OK].
12. Enter a name for the Shortcut using the LCD, and then press [OK].



Related Information

- [Save Your Favourite Settings as a Shortcut](#)

Change or Delete Shortcuts

1. Press  [Shortcuts]. (If  [Shortcuts] is displayed.)
2. Press a tab to display the Shortcut you want to change.
3. Press the Shortcut you want to change.
The settings for the Shortcut you selected appear.



To delete the Shortcut or edit the name, press and hold the Shortcut until the options appear, and then follow the on-screen menus.

4. Press [Options].
5. Change the settings for the Shortcut if needed.
6. Press [OK] (if needed).
7. When finished, press [Save as Shortcut].
8. Read and confirm the displayed list of settings you have selected, and then press [OK].
9. Do one of the following:
 - To overwrite the Shortcut, press [Yes].
 - If you do not want to overwrite the Shortcut, press [No] to enter a new Shortcut name.

Press any  to add a new Shortcut.

Enter a new name using the LCD, and then press [OK].



To edit the name, hold down  to delete the current name.



Related Information

- [Save Your Favourite Settings as a Shortcut](#)

Print Reports

- [Reports](#)
- [Print a Report](#)

Reports

The following reports are available:

Address Book

The Address Book report prints a list of names and numbers stored in the Address Book memory.

Fax Journal (For models with facsimile function)

The Fax Journal prints a list of information about your last 200 incoming and outgoing faxes. (TX means Transmit, RX means Receive.)

User Settings

The User Settings report prints a list of your current settings.

Printer Settings

The Printer Settings report prints a list of your current printer settings.

Network Configuration (Models with network functionality)

The Network Configuration report prints a list of your current network settings.

Print File List

The Print File List prints a list of the fonts and print macro/stream setting stored in the machine.

Drum Dot Print

The Drum Dot Print prints the drum dot sheet, which helps when it is time to clean the drum unit.

WLAN Report (Models with wireless network functionality)



The WLAN Report prints the wireless LAN connectivity diagnosis.



Related Information

- [Print Reports](#)

Print a Report

1. Press  [Settings] > [All Settings] > [Print Reports].
2. Swipe up or down or press ▲ or ▼ to display the report you want to print, and then press it.
3. Press [Yes].
4. Press .



Related Information

- [Print Reports](#)

Settings and Features Tables

The Settings tables will help you understand the menu selections and options that are found in the machine's programs.

- [Settings Tables \(MFC-L5718DN/MFC-L5728DW\)](#)
- [Settings Tables \(DCP-L5518DN\)](#)
- [Features Tables \(MFC-L5718DN/MFC-L5728DW\)](#)
- [Features Tables \(DCP-L5518DN\)](#)

Settings Tables (MFC-L5718DN/MFC-L5728DW)

Related Models: MFC-L5718DN/MFC-L5728DW

```
>> [Settings]
>> [General Setup]
>> [Shortcut Settings]
>> [Fax]
>> [Printer]
>> [Network] (MFC-L5728DW)
>> [Network] (MFC-L5718DN)
>> [Print Reports]
>> [Machine Info.]
>> [Initial Setup]
```

[Settings]

[Settings]

Level 1	Level 2	Descriptions
 Date & Time	-	Access the Date and Time setting menus.
Toner	Toner Life	View the approximate remaining toner life.
	Test Print	Print a test page.
	Toner Cartridge Check	View the installed toner cartridge information on the LCD, for example, if the toner cartridge is genuine.
Network	Wired LAN	Access the Wired LAN setting menus.
	WLAN (Wi-Fi) (MFC-L5728DW)	Access the WLAN setting menus.
Fax Preview	-	View received faxes on the LCD.
Tray Setting	-	Access the tray setting menus.
Eco Mode	-	Access the Eco Mode setting menu.
All Settings	-	Configure the detailed settings.

[General Setup]

[All Settings] > [General Setup]

Level 3	Level 4	Level 5	Level 6	Descriptions
Tray Setting	Paper Type	MP Tray	-	Select the paper type that matches the paper in the MP tray.
		Tray 1	-	Select the paper type that matches the paper in the standard paper tray.
		Tray 2 ¹	-	Select the paper type that matches the paper in the Optional Tray (Tray 2).
		Tray 3 ¹	-	Select the paper type that matches the paper in the Optional Tray (Tray 3).
	Paper Size	MP Tray	-	Select the paper size you loaded in the MP tray.

Level 3	Level 4	Level 5	Level 6	Descriptions	
Tray Setting	Paper Size	Tray 1	-	Select the paper size you loaded in the standard paper tray.	
		Tray 2 ¹	-	Select the paper size you loaded in the Optional Tray (Tray 2).	
		Tray 3 ¹	-	Select the paper size you loaded in the Optional Tray (Tray 3).	
	Tray Use: Copy	-	-	Select the tray you want to use for making a Copy.	
	Tray Use: Fax	-	-	Select the tray you want to use for printing a Fax.	
	Tray Use: Print	-	-	Select the tray you want to use to Print.	
	Print Position	MP Tray	X Offset		Adjust the print start position (usually at the upper left corner of a page) for the paper you loaded in the MP tray horizontally from -500 (left) to +500 (right) dots when printing at 300 dpi.
			Y Offset		Adjust the print start position (usually at the upper left corner of a page) for the paper you loaded in the MP tray vertically from -500 (up) to +500 (down) dots when printing at 300 dpi.
		Tray 1	X Offset		Adjust the print start position (usually at the upper left corner of a page) for the paper you loaded in the standard paper tray horizontally from -500 (left) to +500 (right) dots when printing at 300 dpi.
			Y Offset		Adjust the print start position (usually at the upper left corner of a page) for the paper you loaded in the standard paper tray vertically from -500 (up) to +500 (down) dots when printing at 300 dpi.
		Tray 2 ¹	X Offset		Adjust the print start position (usually at the upper left corner of a page) for the paper you loaded in the Optional tray (Tray 2) horizontally from -500 (left) to +500 (right) dots when printing at 300 dpi.
			Y Offset		Adjust the print start position (usually at the upper left corner of a page) for the paper you loaded in the Optional tray (Tray 2) vertically from -500 (up) to +500 (down) dots when printing at 300 dpi.
		Tray 3 ¹	X Offset		Adjust the print start position (usually at the upper left corner of a page) for the paper you loaded in the Optional tray (Tray 3) horizontally from -500 (left) to +500 (right) dots when printing at 300 dpi.
			Y Offset		Adjust the print start position (usually at the upper left corner of a page) for the paper you loaded in the Optional tray (Tray 3) vertically from -500 (up) to +500 (down) dots when printing at 300 dpi.
		Skip Tray ¹	-	-	Select a specific tray to skip if you know it is loaded with the wrong size paper.
		Separator Tray ¹	-	-	Select the tray that contains the paper used as the separator paper, which is inserted between each print job.
Check Paper	-	-	Select whether or not to display a message indicating you must check the paper type and paper size.		
Volume	Ring	-	-	Adjust the ring volume.	
	Beep	-	-	Adjust the beeper volume.	
	Speaker	-	-	Adjust the speaker volume.	

Level 3	Level 4	Level 5	Level 6	Descriptions
LCD Settings	Backlight	-	-	Adjust the brightness of the LCD backlight.
	Dim Timer	-	-	Set how long the LCD backlight stays on after returning to the Home screen.
Screen Settings	Home Screen	-	-	Set the Main Home screen.
	Scan Screen	-	-	Set the default Scan screen.
	Display Information	IP Address	-	Select whether to display your machine's IP Address on the Home screen.
Notice Settings	Scan Result (Skip Blank Page)	-	-	Displays the total scanned pages and skipped pages after scanning is completed.
Ecology	Eco Mode	-	-	Turn the following machine settings on at the same time: <ul style="list-style-type: none"> • 2-sided Print: Long Edge² • Sleep Time: 0 Min • Dim Timer: 10 Secs • Quiet Mode: On² • Toner Save: On²
	Toner Save	-	-	Increase the page yield of the toner cartridge.
	Sleep Time	-	-	Set how much time should pass before the machine enters Power Saving mode.
	Quiet Mode	-	-	Decrease printing noise.
	Auto Power Off	-	-	Set the number of hours that the machine will remain in Deep Sleep mode before going into Power Off mode.
Improve Output	-	-	-	Enable the Reduce Curl feature or the Toner Fixing feature to improve print output.
Setting Lock	Set Password	-	-	Restrict unauthorised users from changing the machine's settings.
	Lock Off⇒On	-	-	
Delete Storage	Macro ID	-	-	Delete the registered Macro data.
	Stream ID	-	-	Delete the registered Stream data.
	Font ID	-	-	Delete the registered Font data.
	Delete All	-	-	Restore your machine's Macro/Stream and Font data to the factory settings.

¹ Available if the Optional Tray(s) is installed.

² Changing this setting is possible only after you change certain machine settings in Web Based Management.

[Shortcut Settings]

[All Settings] > [Shortcut Settings]

Level 3	Level 4	Descriptions
(Select a shortcut button)	Rename	Change the shortcut name.
	Edit	Change the shortcut settings.
	Delete	Delete the shortcut.
	Register Card/NFC	Assign a shortcut to an ID card.
	Delete Card/NFC	Remove a shortcut from an ID card.

[Fax]

[All Settings] > [Fax]

Level 3	Level 4	Level 5	Descriptions	
Setup Receive	Ring Delay	-	Set the number of rings before the machine answers in Fax Auto mode.	
	Receive Mode	-	Select the Receive Mode that best suits your needs.	
	Fax Preview	-	View received faxes on the LCD.	
	Fax Detect	-	Receive fax messages automatically when you answer a call and hear fax tones.	
	Remote Codes	Remote Codes	-	Answer calls at an extension or external telephone and use codes to turn the Remote Codes on or off. You can personalise the codes.
		Act.Code		
		Deact.Code		
	Auto Reduction	-	Reduce the size of incoming faxes.	
Fax Rx Stamp	-	Print the received time and date on the top of incoming faxes.		
2-sided	-	Print incoming faxes on both sides of the paper.		
Setup Send	Batch TX	-	Combine delayed faxes to the same fax number at the same time of day into one transmission.	
	Auto Redial	-	Set the machine to redial the last fax number after five minutes, if the fax did not go through because the line was busy.	
	Destination	-	Set the machine to display the destination information on the LCD during fax dialling.	
Report Setting	Journal Period	Journal Period	Set the interval for automatic printing of the Fax Journal.	
Dial Restriction	Dial Pad	-	Restrict the dialling when using the dial pad.	
	Address Book	-	Restrict the dialling when using the Address Book.	
	Shortcuts	-	Restrict the dialling when using a Shortcut.	
	LDAP Server	-	Restrict the dialling of LDAP server numbers.	
Remaining Jobs	-	-	Check which scheduled jobs are in the machine's memory and cancel selected jobs.	
Miscellaneous	Fax Mode	-	Select the transmission process when sending or receiving the faxes manually.	

[Printer]

[All Settings] > [Printer]

Level 3	Level 4	Level 5	Descriptions
Emulation	-	-	Select the emulation mode.
Resolution	-	-	Select a print resolution.
Density	-	-	Increase or decrease the print density.
Print Settings	-	-	Set your print settings to Text or Graphics.
Print Options	Font List	HP LaserJet	Print a list of the machine's internal fonts.
		BR-Script 3	
	Test Print	-	Print a test page.

Level 3	Level 4	Level 5	Descriptions
2-sided	2-sided Print	-	Enable or disable 2-sided printing and choose long edge or short edge.
	Single Image	-	For a print job where the last page is a 1-sided image, select the 1-sided Feed option to reduce printing time. When you use Letterhead or Preprinted paper, you must select the 2-sided Feed option. If you select 1-sided Feed for Letterhead or Preprinted paper, the last page will be printed on the reverse side.
Auto Continue	-	-	Select this setting if you want the machine to clear paper size errors or media type errors, and use paper from other trays.
Paper Type	-	-	Set the paper type.
Paper Size	-	-	Set the paper size.
Copies	-	-	Set the number of printed pages.
Orientation	-	-	Set pages to print in either portrait or landscape orientation.
Print Position	-	-	Access the Print Position setting menus.
Auto FF	-	-	Allow the machine to print any remaining data automatically.
HP LaserJet	Font No.	Font No.	Set the font number.
		Soft Font No.	Set the soft font number. This menu appears if a soft font is installed on your Brother machine.
	Font Pitch	-	Set the font pitch. (Available only for certain fonts.)
	Font Point	-	Set the font size. (Available only for certain fonts.)
	Symbol Set	-	Select the symbol or character set.
	Table Print	-	Print the code table.
	Auto LF	-	ON: CR -> CR+LF, OFF: CR -> CR
	Auto CR	-	ON: LF -> LF+CR, FF -> FF+CR, or VT -> VT+CR OFF: LF -> LF, FF -> FF, or VT -> VT
	Auto WRAP	-	Select whether you want a line feed and carriage return when the carriage position reaches the right margin.
	Auto SKIP	-	Select whether you want a line feed and carriage return when the carriage position reaches the bottom margin.
	Left Margin	-	Set the left margin at column 0 to 70 columns at 1 cpi.
	Right Margin	-	Set the right margin at column 10 to 80 columns at 1 cpi.
	Top Margin	-	Set the top margin distance from the top edge of the paper.
	Bottom Margin	-	Set the bottom margin distance from the bottom edge of the paper.
	Lines	-	Set the number of lines on each page.
Tray Command	-	Select this setting if a tray mismatch appears when you use the HP drivers.	
Epson FX-850	Font No.	Font No.	Set the font number.
		Soft Font No.	Set the soft font number. This menu appears if a soft font is installed on your Brother machine.

Level 3	Level 4	Level 5	Descriptions
Epson FX-850	Font Pitch	-	Set the font pitch. (Available only for certain fonts.)
	Font Point	-	Set the font size. (Available only for certain fonts.)
	Character Set	-	Select the symbol or character set.
	Table Print	-	Print the code table. If <i>Change Emulation</i> appears on the LCD, choose the option you want..
	Auto LF	-	ON: CR -> CR+LF, OFF: CR -> CR
	Auto Mask	-	Set the top and bottom margins to two-line each. When you set <i>Auto Mask</i> to On, this setting overrides the <i>Top Margin</i> and <i>Bottom Margin</i> settings.
	Left Margin	-	Set the left margin at column 0 to 70 columns at 1 cpi.
	Right Margin	-	Set the right margin at column 10 to 80 columns at 1 cpi.
	Top Margin	-	Set the top margin distance from the top edge of the paper.
	Bottom Margin	-	Set the bottom margin distance from the bottom edge of the paper.
	Lines	-	Set the number of lines on each page.
IBM Proprinter	Font No.	Font No.	Set the font number.
		Soft Font No.	Set the soft font number. This menu appears if a soft font is installed on your Brother machine.
	Font Pitch	-	Set the font pitch. (Available only for certain fonts.)
	Font Point	-	Set the font size. (Available only for certain fonts.)
	Character Set	-	Select the symbol or character set.
	Table Print	-	Print the code table. If <i>Change Emulation</i> appears on the LCD, choose the option you want.
	Auto LF	-	ON: CR -> CR+LF, OFF: CR -> CR
	Auto CR	-	ON: LF -> LF+CR, FF -> FF+CR, or VT -> VT+CR OFF: LF -> LF, FF -> FF, or VT -> VT
	Auto Mask	-	Set the top and bottom margins to two-line each. When you set <i>Auto Mask</i> to On, this setting overrides the <i>Top Margin</i> and <i>Bottom Margin</i> settings.
	Left Margin	-	Set the left margin at column 0 to 70 columns at 1 cpi.
	Right Margin	-	Set the right margin at column 10 to 80 columns at 1 cpi.
	Top Margin	-	Set the top margin distance from the top edge of the paper.
	Bottom Margin	-	Set the bottom margin distance from the bottom edge of the paper.
	Lines	-	Set the number of lines on each page.
BR-Script 3	Error Print	-	Choose whether the machine prints the error information when errors occur.
PDF	Multiple Page	-	Set the page layout when printing multiple pages.

Level 3	Level 4	Level 5	Descriptions
PDF	PDF Print Options	-	Set the PDF Print setting to print either comments (Markup) or stamps in the PDF file, along with the text.
	PDF Fit to Page	-	Select if the machine scales or resizes the pages in the PDF file to fit the selected paper size.
Carbon Menu	Carbon Copy	-	Enable or disable the Carbon Copy function.
	Copies	-	Set the number of printed pages.
	Copy1 Tray	-	Select the tray you use for Copy1.
	Copy1 Macro	-	Select a macro/stream for Copy1.
	Copy2 Tray... Copy8 Tray	-	Select the tray you use for Copy2 to Copy8.
	Copy2 Macro... Copy8 Macro	-	Select a macro/stream for Copy2 to Copy8.
Reset Printer	-	-	Restore the machine settings to the factory settings.

[Network] (MFC-L5728DW)

[All Settings] > [Network]

Level 3	Level 4	Level 5	Level 6	Descriptions
Wired LAN	TCP/IP	Boot Method	IP Boot Tries	Select the Boot method that best suits your needs.
		IP Address	-	Enter the IP address.
		Subnet Mask	-	Enter the Subnet mask.
		Gateway	-	Enter the Gateway address.
		Node Name	-	Enter the Node name. (Up to 32 characters)
		WINS Configuration	-	Select the WINS configuration mode.
		WINS Server	Primary	Specify the IP address of the primary WINS server.
			Secondary	Specify the IP address of the secondary WINS server.
		DNS Server	Primary	Specify the IP address of the primary DNS server.
			Secondary	Specify the IP address of the secondary DNS server.
	APIPA	-	Set the machine to allocate the IP address from the link-local address range automatically.	
	IPv6	-	Turn the IPv6 protocol on or off.	
	Ethernet	-	-	Select the Ethernet link mode.
	Wired Status	-	-	View the current wired status.
	MAC Address	-	-	View the machine's MAC address.
	Set to Default	-	-	Restore the wired network settings to the factory settings.
Wired Enable	-	-	Turn the Wired LAN interface on or off manually.	

Level 3	Level 4	Level 5	Level 6	Descriptions
WLAN (Wi-Fi)	Find Wi-Fi Network	-	-	Configure your wireless network settings manually.
	TCP/IP	Boot Method	IP Boot Tries	Select the Boot method that best suits your needs.
		IP Address	-	Enter the IP address.
		Subnet Mask	-	Enter the Subnet mask.
		Gateway	-	Enter the Gateway address.
		Node Name	-	Enter the Node name. (Up to 32 characters)
		WINS Configuration	-	Select the WINS configuration mode.
		WINS Server	Primary	Specify the IP address of the primary WINS server.
			Secondary	Specify the IP address of the secondary WINS server.
		DNS Server	Primary	Specify the IP address of the primary DNS server.
			Secondary	Specify the IP address of the secondary DNS server.
	APIPA	-	Set the machine to allocate the IP address from the link-local address range automatically.	
	IPv6	-	Turn the IPv6 protocol on or off.	
	WPS/Push Button	-	-	Configure your wireless network settings using the one-button push method.
	WPS/PIN Code	-	-	Configure your wireless network settings using WPS with a PIN.
	WLAN Status	Status	-	View the current wireless network status.
		Signal	-	View the current wireless network signal strength.
		SSID	-	View the current SSID.
		Comm. Mode	-	View the current Communication mode.
	MAC Address	-	-	View the machine's MAC address.
Set to Default	-	-	Restore the wireless network settings to the factory settings.	
WLAN Enable	-	-	Turns the wireless interface on or off.	
Wi-Fi Direct	Manual	-	-	Configure your Wi-Fi Direct network settings manually.
	Group Owner	-	-	Set your machine as the Group Owner.
	Push Button	-	-	Configure your Wi-Fi Direct network settings using the one-button push method.
	PIN Code	-	-	Configure your Wi-Fi Direct network settings using WPS with a PIN code.
	Device Information	Device Name	-	View your machine's device name.

Level 3	Level 4	Level 5	Level 6	Descriptions	
Wi-Fi Direct	Device Information	SSID	-	View the Group Owner's SSID. When the machine is not connected, the LCD displays Not Connected.	
		IP Address	-	View your machine's current IP Address.	
	Status Information	Status	-	View the current Wi-Fi Direct network status.	
		Signal	-	View the current Wi-Fi Direct network signal strength. When your machine acts as Group Owner, the LCD always indicates a strong signal.	
	I/F Enable	-	-	Turn the Wi-Fi Direct connection on or off.	
E-mail	Mail Address	-	-	Enter the email address. (Up to 255 characters)	
	Setup Server	SMTP	Server	Enter the SMTP server name and address.	
			Port	Enter the SMTP port number.	
			Auth. for SMTP	Select the Security method for email notification.	
			SSL/TLS	Send or receive an email via an email server that requires secure SSL/TLS communication.	
			Verify Cert.	Verify the SMTP Server Certificate automatically.	
		POP3/IMAP4	Protocol	Select the protocol for receiving an email from the server.	
			Server	Enter the server name and address.	
			Port	Enter the port number.	
			Mailbox Name	Enter the mailbox name. (Up to 255 characters)	
			Mailbox Password	Enter the password to log into the server. (Up to 128 characters)	
			Select Folder	Select the specified folder in the mailbox using the IMAP4 protocol.	
			SSL/TLS	Send or receive an email via an email server that requires secure SSL/TLS communication.	
			Verify Cert.	Verify the SMTP Server Certificate automatically.	
			APOP	Turn APOP on or off.	
		Setup Mail RX	Auto Polling	Auto Polling	Check the server for new messages automatically.
				Poll Frequency	Set the interval for checking new messages on the server.
			Header	-	Select the contents of the email header to be printed.

Level 3	Level 4	Level 5	Level 6	Descriptions
E-mail	Setup Mail RX	Del/Read Error Mail	-	The POP3 server deletes error emails automatically. The IMAP4 server deletes error emails automatically after you read them.
		Notification	-	Receive notification messages.
	Setup Mail TX	Sender Subject	-	View the subject.
		Size Limit	Size Limit Maximum Size (MB)	Limit the size of email documents.
		Notification	-	Send notification messages.
		Setup Relay	Relay Broadcast	-
	Relay Domain		Relay ##	Register the Domain name.
	Relay Report		-	Print the relay Broadcast Report.
	Manual Receive	-	-	Check the POP3 or IMAP4 server for new messages manually.
	Web Based Mgmt	-	-	-
Fax to Server	Fax to Server	-	-	Select the network connection type.
	Prefix	-	-	
	Suffix	-	-	
I-Fax Forward	-	-	-	Enable or disable the I-Fax Forward function.
IPsec	-	-	-	IPsec is an optional security feature of the IP protocol that provides authentication and encryption services. We recommend contacting your network administrator before changing this setting.
Global Detect	Allow Detect	-	-	Enable or disable Global Detect, a function that detects and notifies the user when the user unintentionally connects to a global network.
	Reject Access	-	-	Disable connections to the global network.
Network Reset	-	-	-	Restore all network settings back to the factory settings.

[Network] (MFC-L5718DN)

[All Settings] > [Network]

Level 3	Level 4	Level 5	Level 6	Descriptions
Wired LAN	TCP/IP	Boot Method	IP Boot Tries	Select the Boot method that best suits your needs.
		IP Address	-	Enter the IP address.
		Subnet Mask	-	Enter the Subnet mask.

Level 3	Level 4	Level 5	Level 6	Descriptions
Wired LAN	TCP/IP	Gateway	-	Enter the Gateway address.
		Node Name	-	Enter the Node name. (Up to 32 characters)
		WINS Configuration	-	Select the WINS configuration mode.
		WINS Server	Primary	Specify the IP address of the primary WINS server.
			Secondary	Specify the IP address of the secondary WINS server.
		DNS Server	Primary	Specify the IP address of the primary DNS server.
			Secondary	Specify the IP address of the secondary DNS server.
		APIPA	-	Set the machine to allocate the IP address from the link-local address range automatically.
	IPv6	-	Turn the IPv6 protocol on or off.	
	Ethernet	-	-	Select the Ethernet link mode.
	Wired Status	-	-	View the current wired status.
	MAC Address	-	-	View the machine's MAC address.
Wired Enable	-	-	Turn the Wired LAN interface on or off manually.	
E-mail	Mail Address	-	-	Enter the email address. (Up to 255 characters)
	Setup Server	SMTP	Server	Enter the SMTP server name and address.
			Port	Enter the SMTP port number.
			Auth. for SMTP	Select the Security method for email notification.
			SSL/TLS	Send or receive an email via an email server that requires secure SSL/TLS communication.
			Verify Cert.	Verify the SMTP Server Certificate automatically.
		POP3/IMAP4	Protocol	Select the protocol for receiving an email from the server.
			Server	Enter the server name and address.
			Port	Enter the port number.
			Mailbox Name	Enter the mailbox name. (Up to 255 characters)
			Mailbox Password	Enter the password to log into the server. (Up to 128 characters)
			Select Folder	Select the specified folder in the mailbox using the IMAP4 protocol.
			SSL/TLS	Send or receive an email via an email server that requires secure SSL/TLS communication.

Level 3	Level 4	Level 5	Level 6	Descriptions	
E-mail	Setup Server	POP3/IMAP4	Verify Cert.	Verify the SMTP Server Certificate automatically.	
			APOP	Turn APOP on or off.	
	Setup Mail RX	Auto Polling	Auto Polling	Check the server for new messages automatically.	
			Poll Frequency	Set the interval for checking new messages on the server.	
			Header	-	Select the contents of the email header to be printed.
			Del/Read Error Mail	-	The POP3 server deletes error emails automatically. The IMAP4 server deletes error emails automatically after you read them.
			Notification	-	Receive notification messages.
	Setup Mail TX	Sender Subject	-	View the subject.	
		Size Limit	Size Limit	Limit the size of email documents.	
			Maximum Size (MB)		
		Notification	-	Send notification messages.	
	Setup Relay	Relay Broadcast	-	Relay a document to another fax machine.	
		Relay Domain	Relay ##	Register the Domain name.	
		Relay Report	-	Print the relay Broadcast Report.	
Manual Receive	-	-	Check the POP3 or IMAP4 server for new messages manually.		
Web Based Mgmt	-	-	-	Enable or disable Web Based Management. If you enable this function, make sure you specify the connection method to use Web Based Management.	
Fax to Server	Fax to Server	-	-	Select the network connection type.	
	Prefix	-	-		
	Suffix	-	-		
I-Fax Forward	-	-	-	Enable or disable the I-Fax Forward function.	
IPsec	-	-	-	IPsec is an optional security feature of the IP protocol that provides authentication and encryption services. We recommend contacting your network administrator before changing this setting.	
Global Detect	Allow Detect	-	-	Enable or disable Global Detect, a function that detects and notifies the user when the user unintentionally connects to a global network.	
	Reject Access	-	-	Disable connections to the global network.	
Network Reset	-	-	-	Restore all network settings back to the factory settings.	

[Print Reports]

[All Settings] > [Print Reports]

Level 3	Level 4	Descriptions
Address Book	-	Print a list of names and numbers stored in the Address Book.
Fax Journal	-	Print a list of information about your last 200 incoming and outgoing faxes. (TX means Transmit. RX means Receive.)
User Settings	-	Print a list of your User settings.
Printer Settings	-	Print a list of your Printer settings.
Network Configuration	-	Print a list of your Network settings.
Print File List	-	Print a list of data saved in the machine's memory.
Drum Dot Print	-	Print the Drum Dot Check Sheet.
WLAN Report (MFC-L5728DW)	-	Print the wireless LAN connection results.

[Machine Info.]

[All Settings] > [Machine Info.]

Level 3	Level 4	Descriptions
Serial No.	-	Check your machine's serial number.
Firmware Version	Main Version	Check your machine's firmware version.
	Security Version	
Firmware Update	-	Update your machine to the latest firmware.
Firmware Auto Check	-	View firmware information on the Main Home screen.
Page Counter	Total	Check the total number of pages the machine has printed.
	Fax	
	Copy	
	Print	
	Other	
Parts Life ¹	Drum	Display the remaining life of the drum unit.
	Fuser	Display the remaining life of the fuser unit.
	Laser Unit	Display the remaining life of the laser unit.
	PF Kit MP	Display the remaining life of PF Kit MP.
	PF Kit 1	Display the remaining life of PF Kit 1.
	PF Kit 2 ²	Display the remaining life of PF Kit 2.
	PF Kit 3 ²	Display the remaining life of PF Kit 3.

¹ The parts life is approximate and may vary by type of use.

² Available if the Optional Tray(s) is installed.

[Initial Setup]

[All Settings] > [Initial Setup]

Level 3	Level 4	Descriptions
Date & Time	Date	Add the date and time on the screen and in the headings of the faxes you send.
	Time	
	Clock Type	Select the time format (12-hour or 24-hour).
	Time Zone	Set your time zone.
Station ID	Fax	Enter your name and fax number so it appears on each page you fax.
	Tel	
	Name	
Tone/Pulse	-	Select the dialling mode.
Dial Tone	-	Shorten the dial tone detection pause.
Dial Prefix	-	Set a prefix number to be added before the fax number every time you dial.
Compatibility	-	Adjust the equalisation for transmission difficulties. VoIP service providers offer fax support using various standards. If you regularly experience fax transmission errors, select Basic (for VoIP).
Reset	Machine Reset	Restore all the machine settings that you have changed.
	Network Reset	Restore all network settings back to the factory settings.
	Address Book & Fax	Erase all stored phone numbers and fax settings.
	All Settings	Restore all the machine's settings back to the factory settings.
	Factory Reset	Restore all settings back to the factory settings.
Local Language	-	Change your LCD language.



Related Information

- [Settings and Features Tables](#)

Settings Tables (DCP-L5518DN)

Related Models: DCP-L5518DN

```
>> [Settings]
>> [General Setup]
>> [Shortcut Settings]
>> [Printer]
>> [Network] (DCP-L5518DN)
>> [Print Reports]
>> [Machine Info.]
>> [Initial Setup]
```

[Settings]

[Settings]

Level 1	Level 2	Descriptions
 Date & Time	-	Access the Date and Time setting menus.
Toner	Toner Life	View the approximate remaining toner life.
	Test Print	Print a test page.
	Toner Cartridge Check	View the installed toner cartridge information on the LCD, for example, if the toner cartridge is genuine.
Network	Wired LAN	Access the Wired LAN setting menus.
Tray Setting	-	Access the tray setting menus.
Eco Mode	-	Access the Eco Mode setting menu.
All Settings	-	Configure the detailed settings.

[General Setup]

[All Settings] > [General Setup]

Level 3	Level 4	Level 5	Level 6	Descriptions
Tray Setting	Paper Type	MP Tray	-	Select the paper type that matches the paper in the MP tray.
		Tray 1	-	Select the paper type that matches the paper in the standard paper tray.
		Tray 2 ¹	-	Select the paper type that matches the paper in the Optional Tray (Tray 2).
		Tray 3 ¹	-	Select the paper type that matches the paper in the Optional Tray (Tray 3).
	Paper Size	MP Tray	-	Select the paper size you loaded in the MP tray.
		Tray 1	-	Select the paper size you loaded in the standard paper tray.
		Tray 2 ¹	-	Select the paper size you loaded in the Optional Tray (Tray 2).

Level 3	Level 4	Level 5	Level 6	Descriptions
Tray Setting	Paper Size	Tray 3 ¹	-	Select the paper size you loaded in the Optional Tray (Tray 3).
	Tray Use: Copy	-	-	Select the tray you want to use for making a Copy.
	Tray Use: Print	-	-	Select the tray you want to use to Print.
	Print Position	MP Tray	X Offset	Adjust the print start position (usually at the upper left corner of a page) for the paper you loaded in the MP tray horizontally from -500 (left) to +500 (right) dots when printing at 300 dpi.
			Y Offset	Adjust the print start position (usually at the upper left corner of a page) for the paper you loaded in the MP tray vertically from -500 (up) to +500 (down) dots when printing at 300 dpi.
		Tray 1	X Offset	Adjust the print start position (usually at the upper left corner of a page) for the paper you loaded in the standard paper tray horizontally from -500 (left) to +500 (right) dots when printing at 300 dpi.
			Y Offset	Adjust the print start position (usually at the upper left corner of a page) for the paper you loaded in the standard paper tray vertically from -500 (up) to +500 (down) dots when printing at 300 dpi.
		Tray 2 ¹	X Offset	Adjust the print start position (usually at the upper left corner of a page) for the paper you loaded in the Optional tray (Tray 2) horizontally from -500 (left) to +500 (right) dots when printing at 300 dpi.
			Y Offset	Adjust the print start position (usually at the upper left corner of a page) for the paper you loaded in the Optional tray (Tray 2) vertically from -500 (up) to +500 (down) dots when printing at 300 dpi.
	Tray 3 ¹	X Offset	Adjust the print start position (usually at the upper left corner of a page) for the paper you loaded in the Optional tray (Tray 3) horizontally from -500 (left) to +500 (right) dots when printing at 300 dpi.	
		Y Offset	Adjust the print start position (usually at the upper left corner of a page) for the paper you loaded in the Optional tray (Tray 3) vertically from -500 (up) to +500 (down) dots when printing at 300 dpi.	
	Skip Tray ¹	-	-	Select a specific tray to skip if you know it is loaded with the wrong size paper.
	Separator Tray ¹	-	-	Select the tray that contains the paper used as the separator paper, which is inserted between each print job.
Check Paper	-	-	Select whether or not to display a message indicating you must check the paper type and paper size.	
Beep	-	-	-	Adjust the beeper volume.
LCD Settings	Backlight	-	-	Adjust the brightness of the LCD backlight.
	Dim Timer	-	-	Set how long the LCD backlight stays on after returning to the Home screen.
Screen Settings	Home Screen	-	-	Set the Main Home screen.
	Scan Screen	-	-	Set the default Scan screen.
	Display Information	IP Address	-	Select whether to display your machine's IP Address on the Home screen.

Level 3	Level 4	Level 5	Level 6	Descriptions
Notice Settings	Scan Result (Skip Blank Page)	-	-	Displays the total scanned pages and skipped pages after scanning is completed.
Ecology	Eco Mode	-	-	Turn the following machine settings on at the same time: <ul style="list-style-type: none"> • 2-sided Print: Long Edge² • Sleep Time: 0 Min • Dim Timer: 10 Secs • Quiet Mode: On² • Toner Save: On²
	Toner Save	-	-	Increase the page yield of the toner cartridge.
	Sleep Time	-	-	Set how much time should pass before the machine enters Power Saving mode.
	Quiet Mode	-	-	Decrease printing noise.
	Auto Power Off	-	-	Set the number of hours that the machine will remain in Deep Sleep mode before going into Power Off mode.
Improve Output	-	-	-	Enable the Reduce Curl feature or the Toner Fixing feature to improve print output.
Setting Lock	Set Password	-	-	Restrict unauthorised users from changing the machine's settings.
	Lock Off⇒On	-	-	
Delete Storage	Macro ID	-	-	Delete the registered Macro data.
	Stream ID	-	-	Delete the registered Stream data.
	Font ID	-	-	Delete the registered Font data.
	Delete All	-	-	Restore your machine's Macro/Stream and Font data to the factory settings.

¹ Available if the Optional Tray(s) is installed.

² Changing this setting is possible only after you change certain machine settings in Web Based Management.

[Shortcut Settings]

[All Settings] > [Shortcut Settings]

Level 3	Level 4	Descriptions
(Select a shortcut button)	Rename	Change the shortcut name.
	Edit	Change the shortcut settings.
	Delete	Delete the shortcut.
	Register Card/NFC	Assign a shortcut to an ID card.
	Delete Card/NFC	Remove a shortcut from an ID card.

[Printer]

[All Settings] > [Printer]

Level 3	Level 4	Level 5	Descriptions
Emulation	-	-	Select the emulation mode.
Resolution	-	-	Select a print resolution.
Density	-	-	Increase or decrease the print density.

Level 3	Level 4	Level 5	Descriptions
Print Settings	-	-	Set your print settings to Text or Graphics.
Print Options	Font List	HP LaserJet BR-Script 3	Print a list of the machine's internal fonts.
	Test Print	-	Print a test page.
2-sided	2-sided Print	-	Enable or disable 2-sided printing and choose long edge or short edge.
	Single Image	-	For a print job where the last page is a 1-sided image, select the 1-sided Feed option to reduce printing time. When you use Letterhead or Preprinted paper, you must select the 2-sided Feed option. If you select 1-sided Feed for Letterhead or Preprinted paper, the last page will be printed on the reverse side.
Auto Continue	-	-	Select this setting if you want the machine to clear paper size errors or media type errors, and use paper from other trays.
Paper Type	-	-	Set the paper type.
Paper Size	-	-	Set the paper size.
Copies	-	-	Set the number of printed pages.
Orientation	-	-	Set pages to print in either portrait or landscape orientation.
Print Position	-	-	Access the Print Position setting menus.
Auto FF	-	-	Allow the machine to print any remaining data automatically.
HP LaserJet	Font No.	Font No.	Set the font number.
		Soft Font No.	Set the soft font number. This menu appears if a soft font is installed on your Brother machine.
	Font Pitch	-	Set the font pitch. (Available only for certain fonts.)
	Font Point	-	Set the font size. (Available only for certain fonts.)
	Symbol Set	-	Select the symbol or character set.
	Table Print	-	Print the code table.
	Auto LF	-	ON: CR -> CR+LF, OFF: CR -> CR
	Auto CR	-	ON: LF -> LF+CR, FF -> FF+CR, or VT -> VT+CR OFF: LF -> LF, FF -> FF, or VT -> VT
	Auto WRAP	-	Select whether you want a line feed and carriage return when the carriage position reaches the right margin.
	Auto SKIP	-	Select whether you want a line feed and carriage return when the carriage position reaches the bottom margin.
	Left Margin	-	Set the left margin at column 0 to 70 columns at 1 cpi.
	Right Margin	-	Set the right margin at column 10 to 80 columns at 1 cpi.
	Top Margin	-	Set the top margin distance from the top edge of the paper.
	Bottom Margin	-	Set the bottom margin distance from the bottom edge of the paper.
Lines	-	Set the number of lines on each page.	

Level 3	Level 4	Level 5	Descriptions
HP LaserJet	Tray Command	-	Select this setting if a tray mismatch appears when you use the HP drivers.
Epson FX-850	Font No.	Font No.	Set the font number.
		Soft Font No.	Set the soft font number. This menu appears if a soft font is installed on your Brother machine.
	Font Pitch	-	Set the font pitch. (Available only for certain fonts.)
	Font Point	-	Set the font size. (Available only for certain fonts.)
	Character Set	-	Select the symbol or character set.
	Table Print	-	Print the code table. If Change Emulation appears on the LCD, choose the option you want.
	Auto LF	-	ON: CR -> CR+LF, OFF: CR -> CR
	Auto Mask	-	Set the top and bottom margins to two-line each. When you set Auto Mask to On, this setting overrides the Top Margin and Bottom Margin settings.
	Left Margin	-	Set the left margin at column 0 to 70 columns at 1 cpi.
	Right Margin	-	Set the right margin at column 10 to 80 columns at 1 cpi.
	Top Margin	-	Set the top margin distance from the top edge of the paper.
	Bottom Margin	-	Set the bottom margin distance from the bottom edge of the paper.
	Lines	-	Set the number of lines on each page.
IBM Proprinter	Font No.	Font No.	Set the font number.
		Soft Font No.	Set the soft font number. This menu appears if a soft font is installed on your Brother machine.
	Font Pitch	-	Set the font pitch. (Available only for certain fonts.)
	Font Point	-	Set the font size. (Available only for certain fonts.)
	Character Set	-	Select the symbol or character set.
	Table Print	-	Print the code table. If Change Emulation appears on the LCD, choose the option you want.
	Auto LF	-	ON: CR -> CR+LF, OFF: CR -> CR
	Auto CR	-	ON: LF -> LF+CR, FF -> FF+CR, or VT -> VT+CR OFF: LF -> LF, FF -> FF, or VT -> VT
	Auto Mask	-	Set the top and bottom margins to two-line each. When you set Auto Mask to On, this setting overrides the Top Margin and Bottom Margin settings.
	Left Margin	-	Set the left margin at column 0 to 70 columns at 1 cpi.
	Right Margin	-	Set the right margin at column 10 to 80 columns at 1 cpi.
	Top Margin	-	Set the top margin distance from the top edge of the paper.
	Bottom Margin	-	Set the bottom margin distance from the bottom edge of the paper.

Level 3	Level 4	Level 5	Descriptions
IBM Proprinter	Lines	-	Set the number of lines on each page.
BR-Script 3	Error Print	-	Choose whether the machine prints the error information when errors occur.
PDF	Multiple Page	-	Set the page layout when printing multiple pages.
	PDF Print Options	-	Set the PDF Print setting to print either comments (Markup) or stamps in the PDF file, along with the text.
	PDF Fit to Page	-	Select if the machine scales or resizes the pages in the PDF file to fit the selected paper size.
Carbon Menu	Carbon Copy	-	Enable or disable the Carbon Copy function.
	Copies	-	Set the number of printed pages.
	Copy1 Tray	-	Select the tray you use for Copy1.
	Copy1 Macro	-	Select a macro/stream for Copy1.
	Copy2 Tray... Copy8 Tray	-	Select the tray you use for Copy2 to Copy8.
	Copy2 Macro... Copy8 Macro	-	Select a macro/stream for Copy2 to Copy8.
Reset Printer	-	-	Restore the machine settings to the factory settings.

[Network] (DCP-L5518DN)

[All Settings] > [Network]

Level 3	Level 4	Level 5	Level 6	Descriptions
Wired LAN	TCP/IP	Boot Method	IP Boot Tries	Select the Boot method that best suits your needs.
		IP Address	-	Enter the IP address.
		Subnet Mask	-	Enter the Subnet mask.
		Gateway	-	Enter the Gateway address.
		Node Name	-	Enter the Node name. (Up to 32 characters)
		WINS Configuration	-	Select the WINS configuration mode.
		WINS Server	Primary	Specify the IP address of the primary WINS server.
			Secondary	Specify the IP address of the secondary WINS server.
		DNS Server	Primary	Specify the IP address of the primary DNS server.
			Secondary	Specify the IP address of the secondary DNS server.
	APIPA	-	Set the machine to allocate the IP address from the link-local address range automatically.	
	IPv6	-	Turn the IPv6 protocol on or off.	
	Ethernet	-	-	Select the Ethernet link mode.
	Wired Status	-	-	View the current wired status.
MAC Address	-	-	View the machine's MAC address.	

Level 3	Level 4	Level 5	Level 6	Descriptions
Wired LAN	Wired Enable	-	-	Turn the Wired LAN interface on or off manually.
E-mail	Mail Address	-	-	Enter the email address. (Up to 255 characters)
	Setup Server	SMTP	Server	Enter the SMTP server name and address.
			Port	Enter the SMTP port number.
			Auth. for SMTP	Select the Security method for email notification.
			SSL/TLS	Send or receive an email via an email server that requires secure SSL/TLS communication.
			Verify Cert.	Verify the SMTP Server Certificate automatically.
	Setup Mail TX	Sender Subject	-	View the subject.
		Size Limit	Size Limit	Limit the size of email documents.
Maximum Size (MB)				
Notification	-	Send notification messages.		
Web Based Mgmt	-	-	-	Enable or disable Web Based Management. If you enable this function, make sure you specify the connection method to use Web Based Management.
IPsec	-	-	-	IPsec is an optional security feature of the IP protocol that provides authentication and encryption services. We recommend contacting your network administrator before changing this setting.
Global Detect	Allow Detect	-	-	Enable or disable Global Detect, a function that detects and notifies the user when the user unintentionally connects to a global network.
	Reject Access	-	-	Disable connections to the global network.
Network Reset	-	-	-	Restore all network settings back to the factory settings.

[Print Reports]

[All Settings] > [Print Reports]

Level 3	Level 4	Descriptions
Address Book	-	Print a list of names and numbers stored in the Address Book.
User Settings	-	Print a list of your User settings.
Printer Settings	-	Print a list of your Printer settings.
Network Configuration	-	Print a list of your Network settings.
Print File List	-	Print a list of data saved in the machine's memory.
Drum Dot Print	-	Print the Drum Dot Check Sheet.

[Machine Info.]

[All Settings] > [Machine Info.]

Level 3	Level 4	Descriptions
Serial No.	-	Check your machine's serial number.
Firmware Version	Main Version	Check your machine's firmware version.
	Security Version	
Firmware Update	-	Update your machine to the latest firmware.
Firmware Auto Check	-	View firmware information on the Main Home screen.
Page Counter	Total	Check the total number of pages the machine has printed.
	Copy	
	Print	
	Other	
Parts Life ¹	Drum	Display the remaining life of the drum unit.
	Fuser	Display the remaining life of the fuser unit.
	Laser Unit	Display the remaining life of the laser unit.
	PF Kit MP	Display the remaining life of PF Kit MP.
	PF Kit 1	Display the remaining life of PF Kit 1.
	PF Kit 2 ²	Display the remaining life of PF Kit 2.
	PF Kit 3 ²	Display the remaining life of PF Kit 3.

¹ The parts life is approximate and may vary by type of use.

² Available if the Optional Tray(s) is installed.

[Initial Setup]

[All Settings] > [Initial Setup]

Level 3	Level 4	Descriptions
Date & Time	Date	Add the date and time on the screen.
	Time	
	Clock Type	Select the time format (12-hour or 24-hour).
	Time Zone	Set your time zone.
Reset	Machine Reset	Restore all the machine settings that you have changed.
	Network Reset	Restore all network settings back to the factory settings.
	Address Book	Erase all stored email addresses.
	All Settings	Restore all the machine's settings back to the factory settings.
	Factory Reset	Restore all settings back to the factory settings.
Local Language	-	Change your LCD language.



Related Information

- [Settings and Features Tables](#)

Features Tables (MFC-L5718DN/MFC-L5728DW)

Related Models: MFC-L5718DN/MFC-L5728DW

- >> [Wi-Fi® Setup](#)
- >> [\[Toner\]](#)
- >> [\[Fax\] \(When Fax Preview is Off\)](#)
- >> [\[Fax\] \(When Fax Preview is On\)](#)
- >> [\[Copy\]](#)
- >> [\[Scan\]](#)
- >> [\[Shortcuts\]](#)
- >> [\[Receive Mode\]](#)
- >> [\[Secure Print\]](#)
- >> [\[Apps\]](#)
- >> [\[USB\]](#)
- >> [\[2 in 1 ID Copy\]](#)

Wi-Fi® Setup



(Wi-Fi® Setup)

(MFC-L5728DW)

Level 3	Descriptions
Find Wi-Fi Network	Configure your wireless network settings manually.
TCP/IP ¹	Change the TCP/IP settings.
WPS/Push Button	Configure your wireless network settings using the one-button push method.
WPS/PIN Code ¹	Configure the wireless network settings using WPS with a PIN code.
WLAN Status ¹	Display the wireless network connection status.
MAC Address ¹	Display your machine's MAC address.
Set to Default ¹	Restore your machine's wireless network settings to the factory settings.
WLAN Enable ¹	Turn the wireless interface on or off.

¹ Available after a Wi-Fi® connection has been configured.

[Toner]



[Toner]

Level 2	Descriptions
Toner Life	View the approximate remaining toner life.
Test Print	Print a test page.
Toner Cartridge Check	View the installed toner cartridge information on the LCD, for example, if the toner cartridge is genuine.

[Fax] (When Fax Preview is Off)



[Fax] (When Fax Preview is Off)

Level 3	Level 4	Level 5	Level 6	Descriptions
Redial / Pause	-	-	-	Redial the last number called. When you are entering a fax or telephone number on the touchscreen, Redial changes to Pause on the LCD. Press Pause when you need a delay while dialling numbers, such as access codes and credit card numbers. You can also store a pause when you set up addresses.
Hook	-	-	-	Press before dialling if you want to listen to make sure a fax machine has answered, and then press Fax Start.
Address Book	(Search)	-	-	Search within the Address Book.
	Edit	Add New Address	Name	Store Address Book numbers, set up Group numbers for Broadcasting, change and delete Address Book numbers.
			pinyin	
			Address	
		Setup Groups	Name	
	pinyin			
	Add/Delete			
Change	(Select Address)			
Delete	(Select Address)			
(Select Address Book)	Apply	-	Start sending a fax using the Address Book.	
Call History	Redial	-	-	Redial the last number you dialled.
	Outgoing Call	(Select Outgoing Call)	Apply Edit	Select a number from the Outgoing Call history, and then send a fax to it, add it to the Address Book, or delete it.
Fax Start	-	-	-	Send a fax.
Options	Fax Resolution	-	-	Set the resolution for outgoing faxes.
	Contrast	-	-	Adjust the contrast.
	2-sided Fax	-	-	Set the 2-sided scanning format.
	Glass Scan Size	-	-	Adjust the scan area of the scanner glass to the size of the document.
	Broadcasting	Add Number	Add Number	Send the same fax message to more than one fax number.
			Add from Address book	
Search in Address book				
Preview	-	-	-	Preview a fax message before you send it.

Level 3	Level 4	Level 5	Level 6	Descriptions
 Options	Delayed Fax	Delayed Fax	-	Set the time of day the delayed faxes will be sent.
		Set Time	-	
	Overseas Mode	-	-	Set to On if you have difficulty sending faxes overseas.
	Call History	-	-	Select a number from the Outgoing Call history, and then send a fax to it, add it to the Address Book, or delete it.
	Address Book	-	-	Select the address of the recipient from the address book.
	Set New Default	-	-	Save your settings as the default.
	Factory Reset	-	-	Restore all settings back to the factory settings.
Save as Shortcut	-	-	-	Save the current settings as a shortcut.

[Fax] (When Fax Preview is On)



[Fax] (When Fax Preview is On)

Level 3	Level 4	Level 5	Descriptions
Sending Faxes	Redial / Pause	-	Redial the last number called. When you are entering a fax or telephone number on the touchscreen, Redial changes to Pause on the LCD. Press Pause when you need a delay while dialling numbers, such as access codes and credit card numbers. You can also store a pause when you set up addresses.
		Hook	-
	Address Book	-	Select the address of the recipient from the address book.
	Call History	-	Select a number from the Outgoing Call history, and then send a fax to it, add it to the Address Book, or delete it.
	Fax Start	-	Send a fax.
	 Options	-	Select your settings.
	Save as Shortcut	-	Save the current settings as a shortcut.
Received Faxes	Print/Delete	Print All (New Faxes)	Print the new received faxes.
		Print All (Old Faxes)	Print the old received faxes.
		Delete All (New Faxes)	Delete the new received faxes.
		Delete All (Old Faxes)	Delete the old received faxes.
Address Book	-	-	Select the address of the recipient from the address book.
Call History	-	-	Select a number from the Outgoing Call history, and then send a fax to it, add it to the Address Book, or delete it.

[Copy]



[Copy]





Level 3	Level 4	Level 5	Descriptions	
Start	-	-	Make a monochrome or greyscale copy.	
ID	-	-	Make a copy of your ID card.	
 Options	Quality	-	Select the Copy resolution for your document type.	
	Tray Use	-	Select the paper tray you want to use.	
	Enlarge/Reduce	100%	-	
		Enlarge	-	Select an enlargement ratio for the next copy.
		Reduce	-	Select a reduction ratio for the next copy.
		Auto	-	Adjusts the copy size to fit on the paper size you have set.
	Custom (25-400%)	-	Enter an enlargement or reduction ratio.	
	Density	-	Adjust the density.	
	2-sided Copy	Layout	-	Turn off or turn on 2-sided copying and select flip on long edge or flip on short edge.
	2-sided Copy Page Layout	-	-	Select a page layout option when you make 2-sided N in 1 copies from a 2-sided document.
	Contrast	-	-	Adjust the contrast.
	Stack/Sort	-	-	Select to stack or sort multiple copies.
2in1/1in1	-	-	If you select 2 in 1 (ID), you can select the layout options.	
Page Layout	-	-	Make N in 1 and 2 in 1 copies.	
Auto Deskew	-	-	Set the machine to correct document skewing automatically.	
Save as Shortcut	-	-	Save the current settings as a shortcut.	







[Scan]



[Scan]

Level 3	Level 4	Level 5	Level 6	Descriptions	
to USB	Other Scan to Actions	-	-	Scan documents to a USB flash drive.	
	 Options	2-sided Scan	-		-
		Colour Setting	-		-
		Resolution	-		-
		File Type	-		-
		Document Size	-		-
		Brightness	-		-
		Contrast	-		-
		File Name	-		-
		File Name Style	-		-
File Size	-	-			

Level 3	Level 4	Level 5	Level 6	Descriptions		
to USB	 Options	Auto Deskew	-	Scan documents to a USB flash drive.		
		Skip Blank Page	-			
		Skip Blank Page Sensitivity	-			
		Remove Background Colour	-			
		Document Separation	Document Separation		Document Separation Copies Number of Pages	
			Copies			
			Number of Pages			
		B&W TIFF Compress	-			
	Set New Default	-				
	Factory Reset	-				
Save as Shortcut	-	-				
Start	-	-				
to My E-mail	-	-	-	Scan a monochrome or a colour document to your email address.		
to My Folder	-	-	-	Send scanned data to your folder in the CIFS server on your local network or on the Internet.		
to PC	to File	Other Scan to Actions	-	Scan documents and save them to a folder on your computer.		
		(Select USB or PC)	 Options			
			Save as Shortcut			
	Start					
	to OCR	Other Scan to Actions	-		Convert your scanned document to an editable text file.	
		(Select USB or PC)	 Options			
			Save as Shortcut			
	Start					
	to Image	Other Scan to Actions	-			Scan photos or graphics into your graphics applications.
		(Select USB or PC)	 Options			
			Save as Shortcut			
	Start					
to E-mail	Other Scan to Actions	-	Send a scanned document as an email attachment.			
	(Select USB or PC)	 Options				

Level 3	Level 4	Level 5	Level 6	Descriptions
to PC	to E-mail	(Select USB or PC)	Save as Shortcut	Send a scanned document as an email attachment.
			Start	
to Mobile App	Other Scan to Actions	-	-	Scan documents to a mobile application.
	(Select Profile name)	 Options	-	
		Save as Shortcut	-	
		Start	-	
to E-mail Server	Other Scan to Actions	-	-	Scan a monochrome or a colour document to your email server.
	Cancel	-	-	
	Manual	-	-	
	Address Book	 (Search)	-	
		Edit	-	
		(Select Address Book)	-	
	Next	Destinations	-	
		 Options	-	
		Save as Shortcut	-	
		Start	-	
Destinations	(Select Address)	-		
to FTP/SFTP	Other Scan to Actions	-	-	Send scanned data via FTP/SFTP.
	(Select Profile name)	 Options	-	
		Save as Shortcut	-	
		Start	-	
to Network	Other Scan to Actions	-	-	Send scanned data to a CIFS server on your local network or on the Internet.
	(Select Profile name)	 Options	-	
		Save as Shortcut	-	
		Start	-	
to SharePoint	Other Scan to Actions	-	-	Send scanned data via a SharePoint server.
	(Select Profile name)	 Options	-	
		Save as Shortcut	-	
		Start	-	
WS Scan	Other Scan to Actions	-	-	Scan data using the Web Service protocol.

Level 3	Level 4	Level 5	Level 6	Descriptions
(Appears when you install a Web Services Scanner, which is displayed in your computer's Network explorer.)	Scan	-	-	Scan data using the Web Service protocol.
	Scan for E-mail	-	-	
	Scan for Fax	-	-	
	Scan for Print	-	-	

[Shortcuts]

+ [Shortcuts]

Level 3	Level 4	Level 5	Descriptions	
+ Add Shortcut	Copy	-	Select the settings you want.	
	Fax	-	Select the settings you want.	
	Scan	to File		Scan a monochrome or a colour document to your computer.
		to OCR		Convert your scanned document to an editable text file.
		to Image		Scan a colour picture into your graphics application.
		to USB		Scan documents to a USB flash drive.
		to E-mail		Scan a monochrome or a colour document into your email application.
		to E-mail Server		Scan a monochrome or a colour document to the email address you want.
		to Network		Send scanned data to a CIFS server on your local network or on the Internet.
	to FTP/SFTP		Send scanned data via FTP/SFTP.	
to SharePoint		Send scanned data via a SharePoint server.		
	Apps	-	Connect the Brother machine to the Brother Apps service.	
These lists appears when each Shortcut name is pressed for two seconds.	Rename	-	Change the shortcut name.	
	Edit	-	Change the shortcut settings.	
	Delete	-	Delete the shortcut.	
	Register Card/NFC	-	Assign a shortcut to an ID card.	
	Delete Card/NFC	-	Remove a shortcut from an ID card.	

[Receive Mode]



[Receive Mode]

Level 2	Descriptions
Receive Mode	Select the Receive Mode that best suits your needs.

[Secure Print]



[Secure Print]

Level 2	Descriptions
Secure Print	You can print data saved in the machine's memory when you enter your four-digit password. Active only when the machine has secure print data.

[Apps]



[Apps]

Level 2	Descriptions
Apps	Connect the Brother machine to the Brother Apps service.

[USB]



[USB]

Level 2	Level 3	Descriptions
USB	Scan to USB	Scan documents to a USB flash drive.
	Direct Print	Print the data directly from a USB flash drive.

[2 in 1 ID Copy]



[2 in 1 ID Copy]

Level 2	Descriptions
2 in 1 ID Copy	Copy both sides of an identification card onto one page.



Related Information

- [Settings and Features Tables](#)

Features Tables (DCP-L5518DN)

Related Models: DCP-L5518DN

- >> [Toner]
- >> [Copy]
- >> [Scan]
- >> [Shortcuts]
- >> [Secure Print]
- >> [Apps]
- >> [USB]
- >> [2 in 1 ID Copy]

[Toner]

[Toner]

Level 2	Descriptions
Toner Life	View the approximate remaining toner life.
Test Print	Print a test page.
Toner Cartridge Check	View the installed toner cartridge information on the LCD, for example, if the toner cartridge is genuine.

[Copy]



[Copy]

Level 3	Level 4	Level 5	Descriptions	
Start	-	-	Make a monochrome or greyscale copy.	
ID	-	-	Make a copy of your ID card.	
 Options	Quality	-	Select the Copy resolution for your document type.	
	Tray Use	-	Select the paper tray you want to use.	
	Enlarge/Reduce	100%	-	-
		Enlarge	-	Select an enlargement ratio for the next copy.
		Reduce	-	Select a reduction ratio for the next copy.
		Auto	-	Adjusts the copy size to fit on the paper size you have set.
	Custom (25-400%)	-	Enter an enlargement or reduction ratio.	
	Density	-	-	Adjust the density.
	2-sided Copy	Layout	-	Turn off or turn on 2-sided copying and select flip on long edge or flip on short edge.
2-sided Copy Page Layout	-	-	Select a page layout option when you make 2-sided N in 1 copies from a 2-sided document.	
Contrast	-	-	Adjust the contrast.	
Stack/Sort	-	-	Select to stack or sort multiple copies.	







Level 3	Level 4	Level 5	Descriptions
 Options	2in1/1in1	-	If you select 2 in 1 (ID), you can select the layout options.
	Page Layout	-	Make N in 1 and 2 in 1 copies.
	Auto Deskew	-	Set the machine to correct document skewing automatically.
Save as Shortcut	-	-	Save the current settings as a shortcut.



[Scan]



[Scan]

Level 3	Level 4	Level 5	Level 6	Descriptions		
to USB	Other Scan to Actions	-	-	Scan documents to a USB flash drive.		
	 Options	Colour Setting	-		-	
		Resolution	-		-	
		File Type	-		-	
		Document Size	-		-	
		Brightness	-		-	
		Contrast	-		-	
		File Name	-		-	
		File Name Style	-		-	
		File Size	-		-	
		Auto Deskew	-		-	
		Skip Blank Page	-		-	
		Skip Blank Page Sensitivity	-		-	
		Remove Background Colour	-		-	
		Document Separation	Document Separation		Copies	Number of Pages
		B&W TIFF Compress	-		-	-
	Set New Default	-	-		-	
Factory Reset	-	-	-			
Save as Shortcut	-	-	-			
Start	-	-	-			
to My E-mail	-	-	-	Scan a monochrome or a colour document to your email address.		
to My Folder	-	-	-	Send scanned data to your folder in the CIFS server on		

Level 3	Level 4	Level 5	Level 6	Descriptions	
				your local network or on the Internet.	
to PC	to File	Other Scan to Actions	-	Scan documents and save them to a folder on your computer.	
		(Select USB or PC)	 Options		
			Save as Shortcut		
				Start	
	to OCR	Other Scan to Actions	-	Convert your scanned document to an editable text file.	
		(Select USB or PC)	 Options		
			Save as Shortcut		
				Start	
	to Image	Other Scan to Actions	-	Scan photos or graphics into your graphics applications.	
		(Select USB or PC)	 Options		
			Save as Shortcut		
				Start	
to E-mail	Other Scan to Actions	-	Send a scanned document as an email attachment.		
	(Select USB or PC)	 Options			
		Save as Shortcut			
			Start		
to Mobile App	Other Scan to Actions	-	-	Scan documents to a mobile application.	
	(Select Profile name)	 Options	-		
		Save as Shortcut	-		
		Start	-		
to E-mail Server	Other Scan to Actions	-	-	Scan a monochrome or a colour document to your email server.	
	Cancel	-	-		
	Manual	-	-		
	Address Book		-		
		(Search)	-		
		Edit	-		
		(Select Address Book)	-		
Next	Destinations	-			
	 Options	-			

Level 3	Level 4	Level 5	Level 6	Descriptions
to E-mail Server	Next	Save as Shortcut	-	Scan a monochrome or a colour document to your email server.
		Start	-	
	Destinations	(Select Address)	-	
to FTP/SFTP	Other Scan to Actions	-	-	Send scanned data via FTP/SFTP.
	(Select Profile name)	 Options	-	
		Save as Shortcut	-	
		Start	-	
to Network	Other Scan to Actions	-	-	Send scanned data to a CIFS server on your local network or on the Internet.
	(Select Profile name)	 Options	-	
		Save as Shortcut	-	
		Start	-	
to SharePoint	Other Scan to Actions	-	-	Send scanned data via a SharePoint server.
	(Select Profile name)	 Options	-	
		Save as Shortcut	-	
		Start	-	
WS Scan (Appears when you install a Web Services Scanner, which is displayed in your computer's Network explorer.)	Other Scan to Actions	-	-	Scan data using the Web Service protocol.
	Scan	-	-	
	Scan for E-mail	-	-	
	Scan for Fax	-	-	
	Scan for Print	-	-	

[Shortcuts]

+ [Shortcuts]

Level 3	Level 4	Level 5	Descriptions
Add Shortcut	Copy	-	Select the settings you want.
	Scan	to File	Scan a monochrome or a colour document to your computer.
		to OCR	Convert your scanned document to an editable text file.
		to Image	Scan a colour picture into your graphics application.
		to USB	Scan documents to a USB flash drive.
		to E-mail	Scan a monochrome or a colour document into your email application.
		to E-mail Server	Scan a monochrome or a colour document to the email address you want.

Level 3	Level 4	Level 5	Descriptions
Add Shortcut	Scan	to Network	Send scanned data to a CIFS server on your local network or on the Internet.
		to FTP/SFTP	Send scanned data via FTP/SFTP.
		to SharePoint	Send scanned data via a SharePoint server.
These lists appears when each Shortcut name is pressed for two seconds.	Apps	-	Connect the Brother machine to the Brother Apps service.
	Rename	-	Change the shortcut name.
	Edit	-	Change the shortcut settings.
	Delete	-	Delete the shortcut.
	Register Card/NFC	-	Assign a shortcut to an ID card.
Delete Card/NFC	-	Remove a shortcut from an ID card.	

[Secure Print]



[Secure Print]

Level 2	Descriptions
Secure Print	You can print data saved in the machine's memory when you enter your four-digit password. Active only when the machine has secure print data.

[Apps]



[Apps]

Level 2	Descriptions
Apps	Connect the Brother machine to the Brother Apps service.

[USB]



[USB]

Level 2	Level 3	Descriptions
USB	Scan to USB	Scan documents to a USB flash drive.
	Direct Print	Print the data directly from a USB flash drive.

[2 in 1 ID Copy]



[2 in 1 ID Copy]

Level 2	Descriptions
2 in 1 ID Copy	Copy both sides of an identification card onto one page.



Related Information

- [Settings and Features Tables](#)

Change Machine Settings Using Web Based Management

Web Based Management is a utility that uses a standard web browser to manage your machine using the Hyper Text Transfer Protocol (HTTP) or Hyper Text Transfer Protocol over Secure Socket Layer (HTTPS).

- [What is Web Based Management?](#)
- [Access Web Based Management](#)
- [Set or Change a Login Password for Web Based Management](#)
- [Set Up Your Machine's Address Book Using Web Based Management](#)

What is Web Based Management?

Web Based Management is a utility that uses a standard web browser to manage your machine using the Hyper Text Transfer Protocol (HTTP) or Hyper Text Transfer Protocol over Secure Socket Layer (HTTPS).



- We recommend using the latest version of the following web browsers:
 - Microsoft Edge, Firefox, and Google Chrome™ for Windows
 - Safari, Firefox, and Google Chrome™ for Mac
 - Google Chrome™ for Android™
 - Safari and Google Chrome™ for iOS
- Ensure that JavaScript and Cookies are always enabled, regardless of which browser you use.
- Make sure your machine is On and connected to the same network as your computer, and that your network supports the TCP/IP protocol.

XXX-XXXX series brother

The screenshot displays the 'Status' page of the Brother machine's web-based management interface. The left sidebar contains a navigation menu with options: Logout, Home, Status (highlighted), Auto Refresh Interval, General, Address Book, Fax, Copy, Print, Scan, and Administrator. The main content area is titled 'Status' and includes the following sections:

- Device Status:** A green bar indicates the machine is in 'Sleep' mode.
- Automatic Refresh:** Radio buttons for 'Off' (selected) and 'On'.
- Toner Level:** A vertical bar indicates the toner level for 'BK' (Black).
- Web Language:** A dropdown menu set to 'Auto'.
- Device Location:** Fields for 'Contact' and 'Location'.

The actual screen may differ from the screen shown above.



Related Information

- [Change Machine Settings Using Web Based Management](#)

Access Web Based Management

- We recommend using the latest version of the following web browsers:
 - Microsoft Edge, Firefox, and Google Chrome™ for Windows
 - Safari, Firefox, and Google Chrome™ for Mac
 - Google Chrome™ for Android™
 - Safari and Google Chrome™ for iOS
- Ensure that JavaScript and Cookies are always enabled, regardless of which browser you use.
- We recommend using the HTTPS security protocol when configuring settings using Web Based Management.
- When you use HTTPS for Web Based Management configuration, your browser will display a warning dialog box. To avoid displaying the warning dialog box, you can install a self-signed certificate to use SSL/TLS communication. For more information, see *Related Information*.
- The default password to manage this machine's settings is located on the back of the machine and marked "Pwd". We recommend immediately changing the default password to protect your machine from unauthorised access.

You can also find the default password in the Network Configuration Report.

- >> [Access Web Based Management from your Web Browser](#)
- >> [Access Web Based Management from Brother iPrint&Scan \(Windows/Mac\)](#)
- >> [Access Web Based Management from Brother Utilities \(Windows\)](#)

Access Web Based Management from your Web Browser

1. Start your web browser.
2. Type "https://machine's IP address" in your browser's address bar (where "machine's IP address" is your machine's IP address).

For example:

https://192.168.1.2



- If you are using a Domain Name System or enable a NetBIOS name, you can type another name, such as "SharedPrinter" instead of the IP address.

For example: https://SharedPrinter

- If you enable a NetBIOS name, you can also use the node name.

For example: https://brn123456abcdef

- The NetBIOS name can be found in the Network Configuration Report.

3. If required, type the password in the **Login** field, and then click **Login**.



The default password to manage this machine's settings is located on the back of the machine and marked "Pwd".

4. If you want to pin the navigation menu on the left side of the screen, click ☰ and then click .

You can now change the machine's settings.

Access Web Based Management from Brother iPrint&Scan (Windows/Mac)

1. Start Brother iPrint&Scan.

- Windows

Launch  (Brother iPrint&Scan).

- Mac



In the **Finder** menu bar, click **Go > Applications**, and then double-click the iPrint&Scan icon.

The Brother iPrint&Scan screen appears.

2. If your Brother machine is not selected, click the **Select your Machine** button, and then select your model name from the list. Click **OK**.
3. Click  (**Machine Settings**).
4. Click **All Settings**.
The Web Based Management page appears.
5. If required, type the password in the **Login** field, and then click **Login**.



The default password to manage this machine's settings is located on the back of the machine and marked "Pwd".

6. If you want to pin the navigation menu on the left side of the screen, click  and then click .

You can now change the machine's settings.





You can also access Web Based Management from Brother Mobile Connect for mobile devices.

Access Web Based Management from Brother Utilities (Windows)

1. Launch  (**Brother Utilities**), and then click the drop-down list and select your model name (if not already selected).
2. Click **Tools** in the left navigation bar, and then click **Machine Settings**.
The Web Based Management page appears.
3. If required, type the password in the **Login** field, and then click **Login**.



The default password to manage this machine's settings is located on the back of the machine and marked "Pwd".

4. If you want to pin the navigation menu on the left side of the screen, click  and then click .

You can now change the machine's settings.

If you change the protocol settings, you must restart the machine after clicking **Submit** to activate the configuration.

After configuring the settings, click **Logout**.



Related Information

- [Change Machine Settings Using Web Based Management](#)

Related Topics:

- [Print the Network Configuration Report](#)
- [Create a Self-signed Certificate](#)
- [Install the Self-signed Certificate for Windows Users as Administrator](#)
- [Use SSL/TLS](#)

Set or Change a Login Password for Web Based Management

The default password to manage this machine's settings is located on the back of the machine and marked "Pwd". We recommend immediately changing the default password to protect your machine from unauthorised access.

1. Start your web browser.
2. Type "https://machine's IP address" in your browser's address bar (where "machine's IP address" is your machine's IP address).

For example:

https://192.168.1.2



- If you are using a Domain Name System or enable a NetBIOS name, you can type another name, such as "SharedPrinter" instead of the IP address.

For example: https://SharedPrinter

- If you enable a NetBIOS name, you can also use the node name.

For example: https://brn123456abcdef

- The NetBIOS name can be found in the Network Configuration Report.

3. Do one of the following:
 - If you have previously set your own password, type it, and then click **Login**.
 - If you have not previously set your own password, type the default login password, and then click **Login**.
4. Go to the navigation menu, and then click **Administrator > Login Password**.



- The default password to manage this machine's settings is located on the back of the machine and marked "**Pwd**".

- Start from , if the navigation menu is not shown on the left side of the screen.

5. To change the password, type your current password in the **Enter Old Password** field.
6. Following the on-screen **Login Password** guidelines, type your new password in the **Enter New Password** field.
7. Retype the new password in the **Confirm New Password** field.
8. Click **Submit**.



You can also change the lockout settings in the **Login Password** menu.



Related Information

- [Change Machine Settings Using Web Based Management](#)

Set Up Your Machine's Address Book Using Web Based Management

Related Models: MFC-L5718DN/MFC-L5728DW

- We recommend using the HTTPS security protocol when configuring settings using Web Based Management.
- When you use HTTPS for Web Based Management configuration, your browser will display a warning dialog box.

1. Start your web browser.
2. Type "https://machine's IP address" in your browser's address bar (where "machine's IP address" is your machine's IP address).

For example:

https://192.168.1.2



- If you are using a Domain Name System or enable a NetBIOS name, you can type another name, such as "SharedPrinter" instead of the IP address.

For example: https://SharedPrinter

- If you enable a NetBIOS name, you can also use the node name.

For example: https://brn123456abcdef

- The NetBIOS name can be found in the Network Configuration Report.

3. If required, type the password in the **Login** field, and then click **Login**.



The default password to manage this machine's settings is located on the back of the machine and marked "Pwd".

4. Go to the navigation menu, and then click **Address Book**.



Start from , if the navigation menu is not shown on the left side of the screen.

5. Add or update the Address Book information as needed.
6. Click **Submit**.



Related Information

- [Change Machine Settings Using Web Based Management](#)

Appendix

- [Specifications](#)
- [Supplies](#)
- [Accessories](#)
- [Notice](#)
- [Brother Help and Customer Support](#)

Specifications

- >> General Specifications
- >> Document Size Specification
- >> Print Media Specifications
- >> Fax Specifications
- >> Copy Specification
- >> Scanner Specifications
- >> Printer Specifications
- >> Interface Specifications
- >> Direct Print Feature Specifications
- >> Supported Protocols and Security Features
- >> Computer Requirements Specifications

General Specifications

Printer Type		Laser
Print Method		Electrophotographic Laser Printer
Memory Capacity	Standard	1 GB
Machine display		3.5 in. TFT Colour touchscreen LCD 70.08 x 52.56 mm ¹
Power Source		220 V to 240 V AC 50/60 Hz
Power Consumption (Average)	Peak	Approximately 1,280 W
	Printing ²	Approximately 670 W at 25°C
	Printing (Quiet Mode) ²	Approximately 430 W at 25°C
	Copying ²	Approximately 680 W at 25°C
	Copying (Quiet Mode) ²	Approximately 430 W at 25°C
	Ready ²	Approximately 31 W at 25°C
	Sleep ²	Approximately 5.9 W
	Deep Sleep ²	Approximately 0.6 W
	Power Off ^{3 4}	Approximately 0.05 W
Dimensions (Typical outline view)		Unit: mm * : 417 ** : 448 *** : 461
Weight (with supplies)		16.4 kg

Noise Level	Sound Pressure ⁵	Printing	LpAm = 54.0 dB (A)
		Printing (Quiet Mode)	LpAm = 50 dB (A)
		Ready	LpAm = Up to 35.0 dB (A)
	Sound Power	Printing ⁵	LWAc = 7.02 B (A)
		Printing (Quiet Mode)	LWAc = 6.54 B (A)
		Ready	LWAc = Up to 4.9 B (A)
Temperature	Operating	From 10°C to 32.5°C ⁶	
	Storage	From 0°C to 40°C	
Humidity	Operating	20% to 80% (without condensation)	
	Storage	35% to 85% (without condensation)	
Automatic Document Feeder (ADF)			Up to 50 sheets For best results we recommend: <ul style="list-style-type: none"> • Temperature: 20°C to 30°C • Humidity: 50% to 70% • Paper: 80 g/m²

¹ Measured diagonally.

² Measured when the machine is connected using the same network connection as the ENERGY STAR Ver. 3.1 test method.

³ Measured according to IEC 62301 Edition 2.0.

⁴ Power consumption varies slightly depending on the usage environment.

⁵ Measured in accordance with the method described in ISO 7779.

⁶ To ensure the high print quality, the maximum ambient temperature we recommend is 32.5°C. The maximum ambient temperature to safely use this machine is 35°C.

Document Size Specification

Document Size	ADF Width	105 mm to 215.9 mm
	ADF Length	147.3 mm to 355.6 mm
	Scanner Glass Width	Maximum 216 mm
	Scanner Glass Length	Maximum 300 mm

Print Media Specifications

Paper Input	Paper Tray (Standard)	Paper Type	Plain Paper, Letterhead, Coloured Paper, Thin Paper, Recycled Paper, Thick Paper
		Paper Size	A4, Letter, B5 (JIS), A5, A5 (Long Edge), A6, Executive, Legal, Mexico Legal, India Legal, Folio, 16K (195x270 mm), A4 Short (270mm Paper)
		Paper Weight	60 to 163 g/m ² ¹
		Maximum Paper Capacity	Up to 250 sheets of 80 g/m ² Plain Paper
	Multi-Purpose Tray (MP tray)	Paper Type	Plain Paper, Letterhead, Coloured Paper, Thin Paper, Thick Paper, Thicker Paper, Recycled Paper, Bond, Label, Envelope, Env.Thin, Env.Thick
		Paper Size	<ul style="list-style-type: none"> • Width: 69.8 to 215.9 mm • Length: 127 to 355.6 mm

Paper Input	Multi-Purpose Tray (MP tray)		<ul style="list-style-type: none"> Envelope: COM-10, DL, C5, Monarch
		Paper Weight	60 to 230 g/m ² ¹
		Maximum Paper Capacity	<ul style="list-style-type: none"> Up to 100 Sheets of 80 g/m² Plain Paper Envelope: Up to 11 mm thick
	Paper Tray 2, 3 (Optional) ²	Paper Type	Plain Paper, Letterhead, Coloured Paper, Thin Paper, Recycled Paper, Thick Paper
		Paper Size	A4, Letter, B5 (JIS), A5, Executive, Legal, Mexico Legal, India Legal, Folio, 16K (195x270 mm), A4 Short (270mm Paper)
		Paper Weight	60 to 120 g/m ² ¹
		Maximum Paper Capacity	<ul style="list-style-type: none"> LT-5505 Up to 250 sheets of 80 g/m² Plain Paper LT-6505 Up to 520 sheets of 80 g/m² Plain Paper
Paper Output ³	Face Down Output Tray		Up to 150 sheets of 80 g/m ² Plain Paper (face-down delivery to the face-down output paper tray)
	Face Up Output Tray		One sheet (face up delivery to the face up output tray)
2-sided	Automatic 2-sided Printing	Paper Type	Plain Paper, Letterhead, Coloured Paper, Thin Paper, Recycled Paper
		Paper Size	A4
		Paper Weight	60 to 105 g/m ²

¹ For paper of 105 g/m² and above, open the back cover to use the face up output tray.

² Maximum number of Lower Trays: Up to two Lower Trays in any combination.

³ For labels, we recommend removing the printed sheets from the output paper tray immediately after they exit the machine to avoid the possibility of smudging.

Fax Specifications

NOTE

This feature is available for MFC models.

Compatibility		ITU-T Super Group 3
Coding System		MH / MR / MMR / JBIG
Modem Speed		33,600 bps (with Automatic Fallback)
2-sided Print Receiving		Yes
Automatic 2-sided Sending		(MFC-L5718DN/MFC-L5728DW) Yes (from the ADF)
Scanning Width		Maximum 208 mm
Printing Width		Maximum 207.4 mm
Greyscale		8 bit / 256 levels
Resolution	Horizontal	203 dpi
	Vertical	Standard: 98 dpi Fine: 196 dpi Photo: 196 dpi

Address Book ¹	300 Locations
Groups ¹	Up to 20
Broadcasting	350 Locations
Automatic Redial	3 times at 5-minute intervals
Memory Transmission	Up to 500 pages ²
Out of Paper Reception	Up to 500 pages ²

¹ Available for DCP and MFC models

² 'Pages' refers to the 'ITU-T TestChart Document No.1' (a typical business letter, Standard resolution, JBIG code).

Copy Specification

Copy Width	Maximum 210 mm
Automatic 2-sided Copy	(MFC-L5718DN/MFC-L5728DW) Yes (from the ADF)
Sort Copy	Yes
Stack Copy	Up to 999 pages
Enlarge/Reduce	25 to 400% (in increments of 1%)
Resolution	Maximum 1200 x 600 dpi
First Copy Out Time ¹	Less than 8.7 seconds at 23°C

¹ From Ready Mode and standard tray.

Scanner Specifications

Colour / Black	Yes / Yes
TWAIN Compliant	Yes (Windows 10 / Windows 11)
WIA Compliant	Yes (Windows 10 / Windows 11)
Colour Depth	<ul style="list-style-type: none"> • 48 bit colour Processing (Input) • 24 bit colour Processing (Output)
Grey Scale	<ul style="list-style-type: none"> • 16 bit colour Processing (Input) • 8 bit colour Processing (Output)
Resolution ¹	<ul style="list-style-type: none"> • Up to 19200 x 19200 dpi (interpolated) • Up to 1200 x 1200 dpi (from Scanner Glass) • Up to 600 x 600 dpi (from the ADF)
Scanning Width	Maximum 210 mm
Automatic 2-sided Scanning	(MFC-L5718DN/MFC-L5728DW) Yes (from the ADF)

¹ Maximum 1200 × 1200 dpi scanning with the WIA driver in Windows 10 and Windows 11 (resolution up to 19200 × 19200 dpi can be selected by using the scanner utility)

Printer Specifications

Automatic 2-sided Print	Yes
Emulation	PCL6, BR-Script3, IBM Proprinter XL, Epson FX-850, PDF version 1.7, XPS version 1.0

Resolution		<ul style="list-style-type: none"> Physical resolution: 600 x 600 dpi Best print resolution: 1200 x 1200 dpi ¹
Print Speed ²	1-sided Print ^{3 4}	Up to 50 pages/minute (Letter size) Up to 48 pages/minute (A4 size)
	2-sided Print	Up to 24 sides/minute (Up to 12 sheets/minute) (Letter size) Up to 24 sides/minute (Up to 12 sheets/minute) (A4 size)
First Print Time ^{5 6 7}		Less than 6.7 seconds at 23°C

- 1 Data is based on Brother lab test results and may vary from actual print quality due to usage environment and settings. Best print resolution is 1200 x 1200 dpi (measured with print quality set to best mode).
- 2 The print speed may be slower when the machine is connected by wireless LAN.
- 3 The print speeds of "1-sided Print" were measured in accordance with ISO/IEC 24734.
- 4 This speed is based on 1-sided printing. If your model's default print setting is "2-sided", change to "1-sided" for these results.
- 5 Printing from Ready mode and standard tray.
- 6 Length of time from when the machine is started until paper output is complete (except when the machine is turned on or when an error is fixed)
- 7 This applies when printing on A4- or Letter-size paper from the standard tray. It could be longer however, depending on the paper size and the amount of print data.

Interface Specifications

USB	<ul style="list-style-type: none"> Type: USB Type-B receptacle Version: USB 2.0 High-Speed ^{1 2} Use a USB 2.0 interface cable that is no more than 2 metres long. Type: USB Type-A receptacle (Front) ³
LAN	10Base-T/100Base-TX/1000Base-T ⁴
Wireless LAN	(MFC-L5728DW) IEEE 802.11a/b/g/n (Infrastructure Mode) IEEE 802.11a/g/n (Wi-Fi Direct®)

- 1 Your machine has a USB 2.0 Hi-Speed interface. The machine can also be connected to a computer that has a USB 1.1 interface.
- 2 Third party USB hub devices are not supported.
- 3 USB host port
- 4 Use a Category 5e (or greater) network cable.

Direct Print Feature Specifications

Compatibility	PDF version 1.7, JPEG, Exif+JPEG, PRN (created by the machine's own printer driver), TIFF (scanned by Brother models), XPS version 1.0
Interface	USB direct interface: Front x1

Supported Protocols and Security Features

Supported protocols and security features may differ depending the models.

Ethernet

10Base-T/100Base-TX/1000Base-T

Protocols (IPv4)

ARP, RARP, BOOTP, DHCP, APIPA (Auto IP), WINS/NetBIOS name resolution, DNS Resolver, mDNS, LLMNR responder, LPR/LPD, Custom Raw Port/Port9100, POP3, SMTP Client, IPP/IPPS, FTP Client and Server, CIFS Client, TELNET Server, SNMPv1/v2c/v3, HTTP/HTTPS server, TFTP client and server, ICMP, Web Services (Print/Scan), SNTIP Client, LDAP, IMAP4, Syslog

Protocols (IPv6)

NDP, RA, DNS resolver, mDNS, LLNMR responder, LPR/LPD, Custom Raw Port/Port9100, IPP/IPPS, POP3, SMTP Client, FTP Client and Server, CIFS Client, TELNET Server, SNMPv1/v2c/v3, HTTP/HTTPS server, TFTP client and server, ICMPv6, SNTP Client, LDAP, Web Services (Print/Scan), IMAP4, Syslog

Network Security (Wired)

APOP, SMTP-AUTH, SSL/TLS (IPP, HTTP, SMTP, FTP, POP3, IMAP4, LDAP), SNMP v3 802.1x (EAP-MD5, EAP-FAST, PEAP, EAP-TLS, EAP-TTLS), Kerberos, IPsec

Network Security (Wireless)

APOP, SMTP-AUTH, SSL/TLS (IPP, HTTP, SMTP, FTP, POP3, IMAP4, LDAP), SNMP v3, 802.1x (EAP-FAST, PEAP, EAP-TLS, EAP-TTLS), Kerberos, IPsec

Wireless Network Security

WEP 64/128 bit, WPA-PSK (TKIP/AES), WPA2-PSK (TKIP/AES), WPA3-SAE (AES) (Wi-Fi Direct supports WPA2-PSK (AES) only)

Wireless Certification

Wi-Fi Certification Mark License (WPA3™ - Enterprise, Personal), Wi-Fi Protected Setup™ (WPS) Identifier Mark License, Wi-Fi CERTIFIED™ Wi-Fi Direct

Computer Requirements Specifications

Supported Operating Systems And Software Functions

For the latest supported OS, go to your model's **Supported OS** page at support.brother.com/os.

Computer Platform & Operating System Version		Computer Interface			Processor	Hard Disk Space to Install ¹	
		USB ²	10Base-T/ 100Base-TX/ 1000Base-T (Ethernet)	Wireless 802.11a/b/ g/n		For Drivers	For Applications (including Drivers)
Windows Operating System	Windows 10 Home / 10 Pro / 10 Education / 10 Enterprise ^{3 4}	Printing PC Fax ⁵ Scanning			32 bit (x86) or 64 bit (x64) processor	80 MB	1.8 GB
	Windows 11 Home / 11 Pro / 11 Education / 11 Enterprise ^{3 4}				64 bit (x64) processor		
	Windows Server 2012	Printing Scanning			64 bit (x64) processor	80 MB	
	Windows Server 2012 R2						
	Windows Server 2016						
	Windows Server 2019						
	Windows Server 2022						
Mac Operating System ⁶	macOS v11	Printing			64 bit processor	N/A	500 MB
	macOS v12	PC-Fax (Send) ^{5 7}					
	macOS v13	Scanning					

-
- 1 An Internet connection is required to install the software if the installation disc is not supplied.
 - 2 Third party USB ports are not supported.
 - 3 For WIA, 1200x1200 resolution. Brother Scanner Utility enables resolutions up to 19200 x 19200 dpi.
 - 4 PaperPort™ 14SE supports Windows 10 and Windows 11.
 - 5 PC-Fax supports black and white only.
 - 6 macOS Disclaimer
AirPrint capable: Printing or scanning via Mac requires using AirPrint. Mac drivers are not provided.
 - 7 AirPrint only.

For the latest driver updates, go to your model's **Downloads** page at support.brother.com.

All trademarks, brand and product names are the property of their respective companies.



Related Information

- [Appendix](#)
-

Supplies

When the time comes to replace supplies, such as the toner cartridge or drum unit, an error message will appear on your machine's control panel or in the Status Monitor. For more information about the supplies for your machine, visit www.brother.com/original or contact your local Brother dealer.

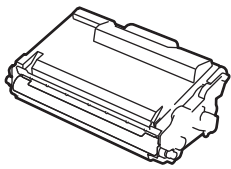
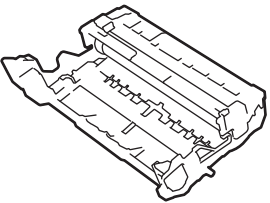

- The toner cartridge and drum unit are two separate parts.
- Supply product codes vary by country and region.

Supply	Supply Product Codes	Approximate Life (Page Yield)	Applicable Models
Toner Cartridge 	Standard Toner: TN3625	Approximately 3,000 pages ^{1 2}	DCP-L5518DN/MFC-L5718DN/ MFC-L5728DW
	High Yield Toner: TN3625XL	Approximately 6,000 pages ^{1 2}	DCP-L5518DN/MFC-L5718DN/ MFC-L5728DW
	Ultra High Yield Toner: TN3635	Approximately 18,000 pages ^{1 2}	DCP-L5518DN/MFC-L5718DN/ MFC-L5728DW
	Inbox Toner: (Supplied with your machine)	Approximately 3,000 pages ^{1 2}	DCP-L5518DN/MFC-L5718DN/ MFC-L5728DW
Drum Unit 	DR3625	Approximately 75,000 pages ³	DCP-L5518DN/MFC-L5718DN/ MFC-L5728DW

¹ A4 or Letter size single-sided pages

² The approximate cartridge yield is declared in accordance with ISO/IEC 19752.

³ Approximately 75,000 pages based on three pages per job and 45,000 pages based on one page per job (A4/Letter single-sided pages). The number of pages may be affected due to a variety of factors including but not limited to media type and media size.



Related Information

- [Appendix](#)

Accessories

Availability of accessories may vary depending on your country or region. For more information about the accessories for your machine, visit www.brother.com/original or contact your Brother dealer or Brother customer service.

Product Codes	Items	Applicable Models
LT-5505	Lower Tray (250 sheets)	DCP-L5518DN/MFC-L5718DN/MFC-L5728DW ¹
LT-6505	Lower Tray (520 sheets)	DCP-L5518DN/MFC-L5718DN/MFC-L5728DW ¹

¹ Maximum number of Lower Trays: Up to two Lower Trays in any combination.



Related Information

- [Appendix](#)

Notice

To create a better environment

Please cooperate.

Firstly, thank you very much indeed for using our Brother products!

Brother focuses on the earth environment concerned. And make a basic policy which is to concern about the earth environment, including any workflow from product development to discard. The local citizen should be responsible for local society and its environment during these environment protection activities.

Therefore, we hope you'll take part in this environment plan, and pay attention to environment protection points as below while discarding used consumables.

1. Please deliver the used package materials to relevant waste disposal office for recycle.
2. When you discard used consumables, please follow and carry on relevant local regulations properly.
3. When the machine need replacing parts for the maintenance and repair, please discard used circuit boards, used electrical parts and products as disposed electrical materials.
4. The power consumption is 0 W after you turn off the machine and unplug it from the AC outlet.
5. Some parts in the machine can be used on the same series model machines which are produced in the same factory.

Note: If you want to replace the parts, please contact Brother Authorized Service Centers.

6. Machines with an LWAd > 63.0 dB(A) are recommended to be set up in separate rooms due to their noise emissions.
7. The machine can use recycled paper.
8. Ensure that during use the machine is used in a well ventilated area.
9. Brother will accept machines and consumables for recycling. For details of the return scheme please refer to the webpage

www.brother.cn/company/info/declaration/20090304.html.



Related Information

- [Appendix](#)

Brother Help and Customer Support

IMPORTANT

For technical and operational assistance, call the call center in mainland China.

To search Frequently asked questions (FAQs)/ASCs/Driver/Manuals, etc, please visit our service website:

support.brother.com

To search where to purchase consumables, please visit the official website of BROTHER (CHINA) LTD.:

www.brother.cn



Related Information

- [Appendix](#)

brother

These machines are approved for use in the country of purchase only. Local Brother companies or their dealers may only support machines purchased in their own countries.



CHN-ENG
Version 0