



# Online User's Guide

**MFC-L9630CDN**

**MFC-L9635CDN**

**MFC-L9670CDN**

**MFC-EX670**

## Table of Contents

|  |           |
|--|-----------|
| <b>Before You Use Your Machine</b> .....   | <b>1</b>  |
| Definitions of Notes .....   | 2         |
| Trademarks .....   | 3         |
| Open Source Licensing .....  | 4         |
| Copyright and License .....  | 5         |
| Important Notes.....   | 6         |
| <b>Introduction to Your Machine</b> .....  | <b>7</b>  |
| Before Using Your Machine .....  | 8         |
| Control Panel Overview .....   | 9         |
| How to Navigate the Touchscreen LCD .....  | 13        |
| How to Enter Text on Your Machine .....  | 14        |
| Customisation of Your Machine .....  | 16        |
| Access Brother Utilities (Windows) .....   | 17        |
| Uninstall the Software and Drivers (Windows) .....   | 19        |
| The Input/Output Ports on Your Machine .....   | 20        |
| <b>Paper Handling</b> .....  | <b>21</b> |
| Load Paper.....  | 22        |
| Load and Print Using the Paper Tray .....  | 23        |
| Load and Print Using the Multi-purpose Tray (MP Tray) .....  | 27        |
| Paper Settings.....  | 35        |
| Change the Paper Size and Paper Type.....  | 36        |
| Select the Paper Tray For Printing .....   | 37        |
| Change the Check Paper Setting .....   | 38        |
| Change the Tray Size for 2-sided Printing .....  | 39        |
| Recommended Print Media.....   | 40        |
| Load Documents .....   | 41        |
| Load Documents in the Automatic Document Feeder (ADF) .....  | 42        |
| Load Documents on the Scanner Glass.....   | 43        |
| Unscannable and Unprintable Areas .....  | 44        |
| Using Special Paper.....   | 45        |
| <b>Print</b> .....   | <b>46</b> |
| Print from Your Computer (Windows).....  | 47        |
| Print a Document (Windows).....  | 48        |
| Print Settings (Windows) .....   | 50        |
| Secure Print (Windows).....  | 55        |
| Change the Default Print Settings (Windows) .....  | 56        |
| Print a Document Using the BR-Script3 Printer Driver (PostScript® 3™ Language Emulation) (Windows) ..... | 58        |
| Monitor the Status of the Machine from Your Computer (Windows) .....                                     | 59        |
| Print from Your Computer (Mac) .....   | 60        |
| Print Using AirPrint .....   | 61        |
| Secure Print Using a USB Flash Drive.....  | 62        |
| Print Data Directly from a USB Flash Drive .....   | 64        |
| Compatible USB Flash Drives .....  | 65        |
| Print Data Directly from a USB Flash Drive or Digital Camera Supporting Mass Storage .....               | 66        |

|  |            |
|--|------------|
| Create a PRN File for Direct Printing (Windows) .....  | 68         |
| Print Duplicate Copies.....  | 69         |
| Cancel a Print Job.....  | 70         |
| Test Print .....   | 71         |
| <b>Scan.....</b>   | <b>72</b>  |
| Scan Using the Scan Button on Your Machine .....   | 73         |
| Scan Photos and Graphics.....  | 74         |
| Save Scanned Data to a Folder as a PDF File .....  | 76         |
| Save Scanned Data to a USB Flash Drive.....  | 78         |
| Scan to an Editable Text File (OCR) .....  | 80         |
| Save Scanned Data as an Email Attachment .....   | 82         |
| Send Scanned Data to an Email Recipient .....  | 84         |
| Scan to FTP .....  | 86         |
| Scan to SSH Server (SFTP) .....  | 90         |
| Scan to Network (Windows).....   | 97         |
| Scan to SharePoint .....   | 103        |
| Use the Web Services Protocol for Network Scanning (Windows 7, Windows 8.1, and Windows 10)..... | 107        |
| Change the Scan Button Settings from Brother iPrint&Scan .....                                   | 111        |
| Configure Certificates for Signed PDFs .....   | 112        |
| Disable Scanning from Your Computer .....  | 114        |
| Scan from Your Computer (Windows).....   | 115        |
| Scan Using Brother iPrint&Scan (Windows/Mac).....  | 116        |
| Scan Using Nuance™ PaperPort™ 14SE or Other Windows Applications.....                            | 117        |
| Scan Using Windows Fax and Scan .....  | 122        |
| Scan from Your Computer (Mac).....   | 126        |
| Configure Scan Settings Using Web Based Management.....  | 127        |
| Set the Scan File Name Using Web Based Management.....   | 128        |
| Set the Scan Job Email Report Using Web Based Management .....                                   | 129        |
| <b>Copy .....</b>  | <b>130</b> |
| Copy on One Side of the Paper (1-sided).....   | 131        |
| Copy on Both Sides of the Paper (2-sided).....   | 134        |
| Enlarge or Reduce Copied Images .....  | 136        |
| Make N in 1 Copies Using the Page Layout Feature .....   | 137        |
| Interrupt a Print Job with a Copy Job .....  | 138        |
| Copy an ID Card .....  | 139        |
| Copy Options .....   | 140        |
| <b>Fax.....</b>  | <b>142</b> |
| Send a Fax.....  | 143        |
| Send a Fax .....   | 144        |
| Send a 2-sided Fax from the ADF .....  | 146        |
| Send a Fax Manually.....   | 147        |
| Send a Fax at the End of a Conversation .....  | 148        |
| Send the Same Fax to More than One Recipient (Broadcasting) .....                                | 149        |
| Send a Fax in Real Time .....  | 151        |
| Send a Fax at a Specified Time (Delayed Fax).....  | 152        |
| Add a Cover Page to Your Fax.....  | 153        |

|  |            |
|--|------------|
| Cancel a Fax in Progress .....   | 155        |
| Check and Cancel a Pending Fax .....                                   | 156        |
| Fax Options .....  | 157        |
| Receive a Fax .....  | 158        |
| Receive Mode Settings .....  | 159        |
| Memory Receive Options .....   | 169        |
| Remote Fax Retrieval.....  | 176        |
| Voice Operations and Fax Numbers .....                                 | 182        |
| Voice Operations .....   | 183        |
| Store Fax Numbers .....  | 185        |
| Set up Broadcasting Groups .....                                       | 189        |
| Combine Address Book Numbers .....                                     | 193        |
| Telephone Services and External Devices.....                           | 194        |
| Use BT Call Sign .....   | 195        |
| Set the Telephone Line Type.....                                       | 197        |
| External TAD (Telephone Answering Device).....                         | 199        |
| External and Extension Telephones .....                                | 202        |
| Multi-line Connections (PBX) .....                                     | 209        |
| Fax Reports.....   | 210        |
| Print a Transmission Verification Report .....                         | 211        |
| Print a Fax Journal .....  | 212        |
| PC-FAX .....   | 213        |
| PC-FAX for Windows .....   | 214        |
| PC-FAX for Mac .....   | 233        |
| <b>Network .....</b>   | <b>234</b> |
| Supported Basic Network Features .....                                 | 235        |
| Configure Network Settings .....                                       | 236        |
| Configure Network Details Using the Control Panel.....                 | 237        |
| Wireless Network Settings .....  | 238        |
| Use the Wireless Network .....   | 239        |
| Use Wi-Fi Direct® .....  | 252        |
| Enable/Disable Wireless LAN .....                                      | 256        |
| Print the WLAN Report.....   | 257        |
| Network Features.....  | 261        |
| Print the Network Configuration Report.....                            | 262        |
| Fax Using the Internet (I-Fax) .....                                   | 263        |
| Use the Send Fax to Server Feature.....                                | 284        |
| Configure and Operate LDAP Search.....                                 | 288        |
| Synchronise Time with the SNTP Server Using Web Based Management ..... | 292        |
| Gigabit Ethernet (Wired Network Only) .....                            | 295        |
| Reset the Network Settings to the Factory Settings.....                | 297        |
| <b>Security .....</b>  | <b>298</b> |
| Before Using Network Security Features .....                           | 299        |
| Configure Certificates for Device Security .....                       | 300        |
| Supported Security Certificate Features .....                          | 301        |
| Step by Step Guide for Creating and Installing a Certificate .....     | 302        |
| Create a Self-signed Certificate .....                                 | 303        |



|  |     |
|--|-----|
| Create CSR and Install a Certificate from a Certificate Authority (CA) .....                                       | 304 |
| Import and Export the Certificate and Private Key .....  | 308 |
| Import and Export a CA Certificate.....  | 311 |
| Manage Multiple Certificates .....   | 314 |
| Use SSL/TLS .....  | 315 |
| Introduction to SSL/TLS .....  | 316 |
| Manage Your Network Machine Securely Using SSL/TLS.....  | 319 |
| Print Documents Securely Using SSL/TLS .....   | 324 |
| Use SNMPv3.....  | 326 |
| Manage Your Network Machine Securely Using SNMPv3 .....  | 327 |
| Use IPsec.....   | 328 |
| Introduction to IPsec.....   | 329 |
| Configure IPsec Using Web Based Management .....   | 330 |
| Configure an IPsec Address Template Using Web Based Management .....   | 331 |
| Configure an IPsec Template Using Web Based Management .....   | 333 |
| Use IEEE 802.1x Authentication for a Wired or a Wireless Network .....   | 342 |
| What Is IEEE 802.1x Authentication? .....  | 343 |
| Configure IEEE 802.1x Authentication for a Wired or Wireless Network Using Web Based Management (Web Browser)..... | 344 |
| IEEE 802.1x Authentication Methods.....  | 346 |
| Use Active Directory Authentication.....   | 347 |
| Introduction to Active Directory Authentication.....   | 348 |
| Configure Active Directory Authentication Using Web Based Management .....   | 349 |
| Log On to Change the Machine Settings Using the Machine's Control Panel (Active Directory Authentication) .....    | 351 |
| Use LDAP Authentication.....   | 352 |
| Introduction to LDAP Authentication .....  | 353 |
| Configure LDAP Authentication Using Web Based Management.....  | 354 |
| Log On to Change the Machine Settings Using the Machine's Control Panel (LDAP Authentication) .....                | 355 |
| Use Secure Function Lock 3.0 .....   | 356 |
| Before Using Secure Function Lock 3.0.....   | 357 |
| Configure Secure Function Lock 3.0 Using Web Based Management .....  | 358 |
| Scan Using Secure Function Lock 3.0 .....  | 359 |
| Configure Public Mode for Secure Function Lock 3.0 .....   | 360 |
| Configure Personal Home Screen Settings Using Web Based Management.....  | 361 |
| Additional Secure Function Lock 3.0 Features.....  | 362 |
| Register a new ID Card Using the Machine's Control Panel .....   | 363 |
| Send or Receive an Email Securely.....   | 364 |
| Configure Email Sending or Receiving Using Web Based Management.....   | 365 |
| Send an Email with User Authentication .....   | 366 |
| Send or Receive an Email Securely Using SSL/TLS .....  | 367 |
| Store Print Log to Network .....   | 368 |
| Store Print Log to Network Overview .....  | 369 |
| Configure the Store Print Log to Network Settings Using Web Based Management.....                                  | 370 |
| Use the Store Print Log to Network's Error Detection Setting .....   | 372 |
| Use Store Print Log to Network with Secure Function Lock 3.0.....  | 374 |
| Lock the Machine Settings from the Control Panel .....   | 375 |

|   |            |
|---|------------|
| Setting Lock Overview.....  | 376        |
| <b>Administrator.....</b>   | <b>381</b> |
| Network Features.....   | 382        |
| Security Features.....  | 383        |
| Network Security.....   | 384        |
| User Authentication.....  | 386        |
| Brother Management Tools.....   | 387        |
| <b>Mobile/Web Connect.....</b>  | <b>388</b> |
| Brother Web Connect.....  | 389        |
| Brother Web Connect Overview.....                                       | 390        |
| Online Services Used with Brother Web Connect.....                      | 393        |
| Set Up Brother Web Connect.....   | 395        |
| Scan and Upload Documents Using Brother Web Connect.....                | 403        |
| Download and Print Documents Using Brother Web Connect.....             | 404        |
| FaxForward to Cloud or E-mail.....                                      | 407        |
| AirPrint.....   | 410        |
| AirPrint Overview.....  | 411        |
| Before Using AirPrint (macOS).....                                      | 412        |
| Print Using AirPrint.....   | 413        |
| Scan Using AirPrint (macOS).....  | 416        |
| Send a Fax Using AirPrint (macOS).....                                  | 417        |
| Mopria® Print Service.....  | 418        |
| Brother Mobile Connect.....   | 419        |
| Register an External IC Card Reader.....                                | 420        |
| <b>Brother iPrint&amp;Scan.....</b>                                     | <b>421</b> |
| Access Brother iPrint&Scan (Windows/Mac).....                           | 422        |
| <b>Troubleshooting.....</b>   | <b>423</b> |
| Error and Maintenance Messages.....                                     | 424        |
| Transfer Your Faxes or Fax Journal Report.....                          | 431        |
| Error Messages When Using the Brother Web Connect Feature.....          | 435        |
| Document Jams.....  | 437        |
| Document is Jammed in the Top of the ADF Unit.....                      | 438        |
| Document is Jammed under the Document Cover.....                        | 439        |
| Remove Small Scraps of Paper Jammed in the ADF.....                     | 440        |
| Paper Jams.....   | 441        |
| Clear Paper Jams.....   | 442        |
| Paper is Jammed in the MP tray.....                                     | 443        |
| Paper is Jammed in the Paper Tray.....                                  | 444        |
| Paper is Jammed in the Back of the Machine.....                         | 446        |
| Paper is Jammed Inside the Machine.....                                 | 449        |
| Paper is Jammed in the 2-sided Tray.....                                | 452        |
| Printing Problems.....  | 453        |
| Improve the Print Quality.....  | 456        |
| Telephone and Fax Problems.....   | 461        |
| Set Dial Tone Detection.....  | 464        |
| Set Telephone Line Compatibility for Interference and VoIP Systems..... | 465        |
| Network Problems.....   | 466        |







|  |            |
|--|------------|
| Error Messages .....   | 467        |
| Use the Network Connection Repair Tool (Windows) .....         | 469        |
| Check Your Machine's Network Settings.....                     | 470        |
| If You Are Having Difficulty with Your Machine's Network ..... | 471        |
| AirPrint Problems .....  | 478        |
| Other Problems .....   | 479        |
| Check the Machine Information .....                            | 481        |
| Reset Your Machine .....                                       | 482        |
| Reset Functions Overview .....                                 | 483        |
| <b>Routine Maintenance .....</b>                               | <b>484</b> |
| Replace Supplies .....   | 485        |
| Replace the Toner Cartridge .....                              | 487        |
| Replace the Drum Unit.....                                     | 490        |
| Replace the Belt Unit.....                                     | 493        |
| Replace the Waste Toner Box .....                              | 496        |
| Clean the Machine .....  | 500        |
| Clean the Scanner.....   | 502        |
| Clean the Laser Scanner Windows .....                          | 503        |
| Clean the Touchscreen LCD .....                                | 505        |
| Clean the Corona Wires .....                                   | 506        |
| Clean the Drum Unit.....                                       | 509        |
| Clean the Paper Pick-up Rollers .....                          | 514        |
| Correct Colour Printing.....                                   | 516        |
| Set the Auto Correction Function .....                         | 517        |
| Reset the Machine's Colour Correction Settings.....            | 518        |
| Check the Remaining Part Life .....                            | 519        |
| Pack and Ship Your Machine .....                               | 520        |
| Replace Periodic Maintenance Parts .....                       | 522        |
| <b>Machine Settings.....</b>                                   | <b>523</b> |
| Change Machine Settings from the Control Panel.....            | 524        |
| In the Event of Power Failure (Memory Storage) .....           | 525        |
| General Settings.....  | 526        |
| Save Your Favourite Settings as a Shortcut.....                | 542        |
| Print Reports .....  | 546        |
| Settings and Features Tables .....                             | 549        |
| Change Machine Settings from Your Computer.....                | 573        |
| Change Machine Settings Using Web Based Management .....       | 574        |
| <b>Appendix.....</b>   | <b>579</b> |
| Specifications .....   | 580        |
| Supplies .....   | 588        |
| Important Information About Toner Cartridge Life .....         | 590        |
| Environmental and Compliance Information .....                 | 591        |
| Information Regarding Recycled Paper .....                     | 592        |
| Availability of Service Parts .....                            | 593        |
| Chemical Substances (EU REACH).....                            | 594        |
| Accessories.....   | 595        |
| Brother Help and Customer Support.....                         | 596        |

## Before You Use Your Machine

- [Definitions of Notes](#)
- [Trademarks](#)
- [Open Source Licensing](#)
- [Copyright and License](#)
- [Important Notes](#)

## Definitions of Notes

We use the following symbols and conventions throughout this User's Guide:

|  |   |
|--|---|
|  <b>WARNING</b> | WARNING indicates a potentially hazardous situation which, if not avoided, could result in death or serious injuries.                           |
|  <b>CAUTION</b> | CAUTION indicates a potentially hazardous situation which, if not avoided, may result in minor or moderate injuries.                            |
| <b>IMPORTANT</b>   | IMPORTANT indicates a potentially hazardous situation which, if not avoided, may result in damage to property or loss of product functionality. |
| <b>NOTE</b>  | NOTE specifies the operating environment, conditions for installation, or special conditions of use.  |
|                 | Tips icons indicate helpful hints and supplementary information.  |
|                 | Electrical Hazard icons alert you to possible electrical shock.   |
|                 | Fire Hazard icons alert you to the possibility of a fire.   |
|                 | Hot Surface icons warn you not to touch hot machine parts.  |
|                 | Prohibition icons indicate actions you must not perform.  |
| <b>Bold</b>  | Bold style identifies buttons on the machine's control panel or computer screen.  |
| <i>Italics</i>   | Italicised style emphasises an important point or refers you to a related topic.  |
| Courier New  | Courier New font identifies messages shown on the machine's LCD.  |

### Related Information

- [Before You Use Your Machine](#)

## Trademarks

Apple, App Store, Mac, macOS, Safari, AirPrint, the AirPrint logo, iPad, iPhone, iPod touch and iPadOS are trademarks of Apple Inc., registered in the U.S. and other countries.

Nuance and PaperPort are trademarks or registered trademarks of Nuance Communications, Inc. or its affiliates in the United States and/or other countries.

Adobe, PostScript and PostScript 3 are either registered trademarks or trademarks of Adobe Systems Incorporated in the United States and/or other countries.

Wi-Fi, Wi-Fi Alliance and Wi-Fi Direct are registered trademarks of Wi-Fi Alliance®.

WPA, WPA2, Wi-Fi CERTIFIED, Wi-Fi Protected Setup and Wi-Fi Protected Setup logo are trademarks of Wi-Fi Alliance®.

Android, Google Drive, Google Chrome and Google Play are trademarks of Google LLC. Use of these trademarks is subject to Google Permissions.

Mopria® and the Mopria® Logo are registered and/or unregistered trademarks and service marks of Mopria Alliance, Inc. in the United States and other countries. Unauthorised use is strictly prohibited.

Evernote is a trademark of Evernote Corporation and used under a license.

The Bluetooth® word mark is a registered trademark owned by Bluetooth SIG, Inc. and any use of such marks by Brother Industries, Ltd. is under license. Other trademarks and trade names are those of their respective owners.

Each company whose software title is mentioned in this manual has a Software Licence Agreement specific to its proprietary programs.

### Software Trademarks

FlashFX® is a registered trademark of Datalight, Inc.

FlashFX® Pro™ is a trademark of Datalight, Inc.

FlashFX® Tera™ is a trademark of Datalight, Inc.

Reliance™ is a trademark of Datalight, Inc.

Reliance Nitro™ is a trademark of Datalight, Inc.

Datalight® is a registered trademark of Datalight, Inc.

**Any trade names and product names of companies appearing on Brother products, related documents and any other materials are all trademarks or registered trademarks of those respective companies.**



### Related Information

- [Before You Use Your Machine](#)

## Open Source Licensing

This product includes open-source software.

To view Open Source Licensing Remarks and Copyright Information, go to your model's **Manuals** page at [support.brother.com](http://support.brother.com).



### Related Information

- [Before You Use Your Machine](#)
-

## Copyright and License

©2021 Brother Industries, Ltd. All rights reserved.

This product includes software developed by the following vendors:

This product includes the "KASAGO TCP/IP" software developed by ZUKEN ELMIC, Inc.

Copyright 1989-2020 Datalight, Inc., All Rights Reserved.

FlashFX® Copyright 1998-2020 Datalight, Inc.

U.S.Patent Office 5,860,082/6,260,156



### Related Information

- [Before You Use Your Machine](#)
-



## Important Notes

- Check [support.brother.com](http://support.brother.com) for Brother driver and software updates.
- To keep your machine performance up to date, check [support.brother.com](http://support.brother.com) for the latest firmware upgrade. Otherwise, some of your machine's functions may not be available.
- Do not use this product outside the country of purchase as it may violate the wireless telecommunication and power regulations of that country.
- Not all models are available in all countries.
- Before giving your machine to anyone else, replacing it, or disposing of it, Brother strongly recommends resetting it to its factory settings to remove all personal information.
- Windows 10 in this document represents Windows 10 Home, Windows 10 Pro, Windows 10 Education and Windows 10 Enterprise.
- Windows Server 2008 in this document represents Windows Server 2008 and Windows Server 2008 R2.
- The screens or images in this User's Guide are for illustration purposes only and may differ from those of the actual products.
- Unless otherwise specified, the screens in this manual are from Windows 10. Screens on your computer may vary depending on your operating system.
- The contents of this document and the specifications of this product are subject to change without notice.
- In this document XXX-XXXX represents your machine's model name.
- Not all features are available in countries subject to applicable export restrictions.



### Related Information

- [Before You Use Your Machine](#)

## Introduction to Your Machine

- [Before Using Your Machine](#)
- [Control Panel Overview](#)
- [How to Navigate the Touchscreen LCD](#)
- [How to Enter Text on Your Machine](#)
- [Customisation of Your Machine](#)
- [Access Brother Utilities \(Windows\)](#)
- [The Input/Output Ports on Your Machine](#)

## Before Using Your Machine

Before attempting any printing operation, confirm the following:

- Make sure you have installed the correct software and drivers for your machine.
- For USB or network cable users: Make sure the interface cable is physically secure.

### Simultaneous printing, scanning, and faxing

Your machine can print from your computer while sending or receiving a fax into memory or while scanning a document into the computer. Fax sending will not be stopped during printing from your computer. However, when the machine is copying or receiving a fax on paper, it pauses the printing operation, and then continues printing when copying or fax receiving has finished.

### Firewall (Windows)

If your computer is protected by a firewall and you are unable to network print, network scan, or PC-FAX, you may need to configure the firewall settings. If you are using the Windows Firewall and you installed the drivers using the steps in the installer, the necessary firewall settings have been already set. If you are using any other personal firewall software, see the User's Guide for your software or contact the software manufacturer.

### Related Information

- [Introduction to Your Machine](#)

## Control Panel Overview

The control panel may vary depending on your model.

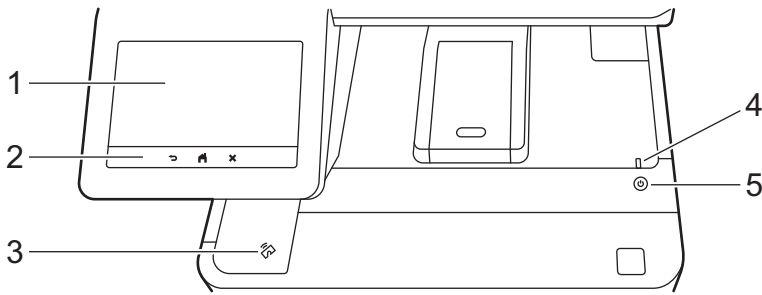

### 1. Touchscreen Liquid Crystal Display (LCD)

Access menus and options by pressing them on the touchscreen.

Your machine has eight tabbed screens (referred to as Home screens). Each Home screen can hold up to eight icons which can be used for machine functions, settings, or shortcuts.

The Main Home screen can be selected from the Home screens.

Use the [Admin Settings] menu to rename the Home screens and rearrange the icons.

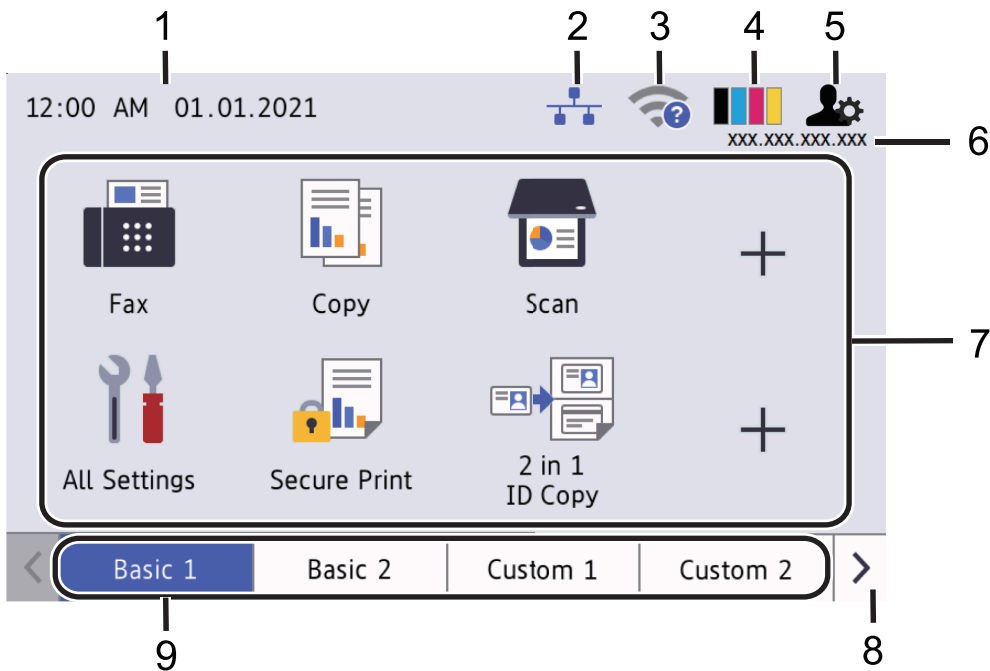

#### 1. Date & Time



Displays the date and time set on the machine.

This area is also used to display error or maintenance messages.

#### 2. (Wired LAN Status)

Press to configure the Wired LAN settings.

The icon displays the current wired network status.

-  Wired LAN Disabled (Grey)
-  Wired LAN Enabled (Blue)
-  No cable connection

---

### 3. (Wireless Status)

Press to configure wireless settings.

For certain models, the Home screens display the wireless status only when the optional Wireless Module is installed.

If you are using a wireless connection, a four-level indicator displays the current wireless signal strength.



### 4. (Toner)

Displays the remaining toner life. Press to access the [Toner] menu.

### 5. (Admin Settings)











Press to access the [Admin Settings] menu.

### 6. IP Address

If the IP Address setting in the Display Information menu has been turned on, your machine's IP Address appears on the Home screens.

### 7. Function Icons, Setting Icons, and Shortcut Icons

The available features vary depending on your model.

-  [All Settings]  
Press to access the machine's settings menu.
-  [Fax]  
Press to access Fax mode.
-  [Copy]  
Press to access Copy mode.
-  [Scan]  
Press to access the Scan mode.
-  [Secure Print]  
Press to access the [Secure Print] option.
-  [USB]  
Press to access the USB menu and select [Scan to USB] or [Direct Print] options.
-  [Web]  
Press to connect your machine to an Internet service.
-  [Apps]  
Press to connect your machine to the Brother Apps service.
-  [2 in 1 ID Copy]  
Press to access the 2 in 1 ID Copy option.
-  [Eco Mode]  
Press to access the [Eco Mode] menu.
-  (Shortcuts)

Press to access your Shortcuts for frequently used functions, such as sending a fax, copying, scanning, and using Web Connect.

## 8. Tabs Scroll Buttons

Press to display and access all the tabs.

## 9. Home Tabs

Press to display the screen for the Home.

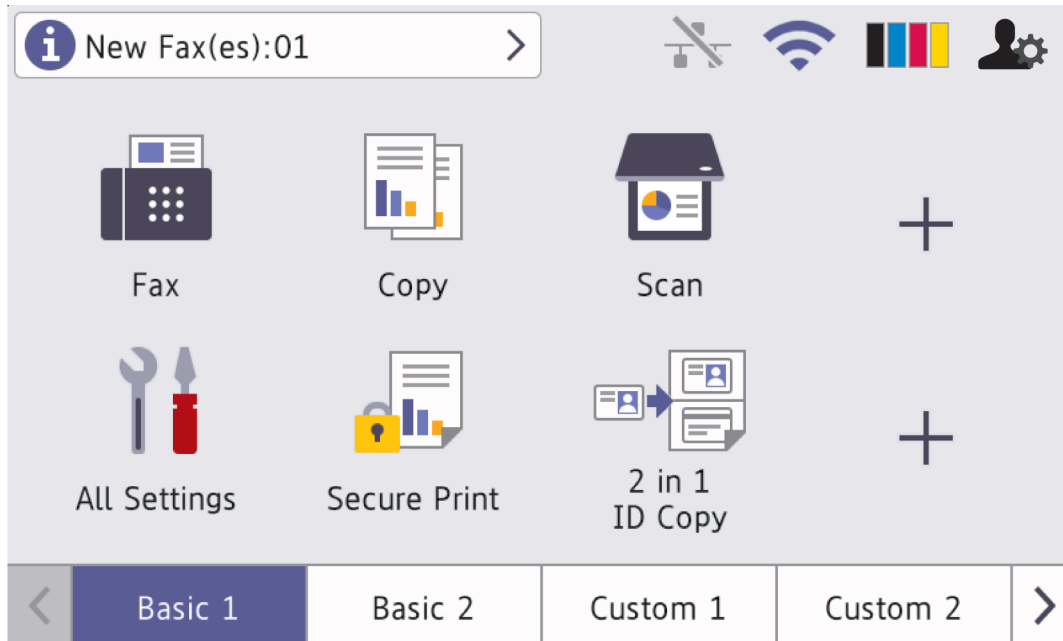

- **New Fax**

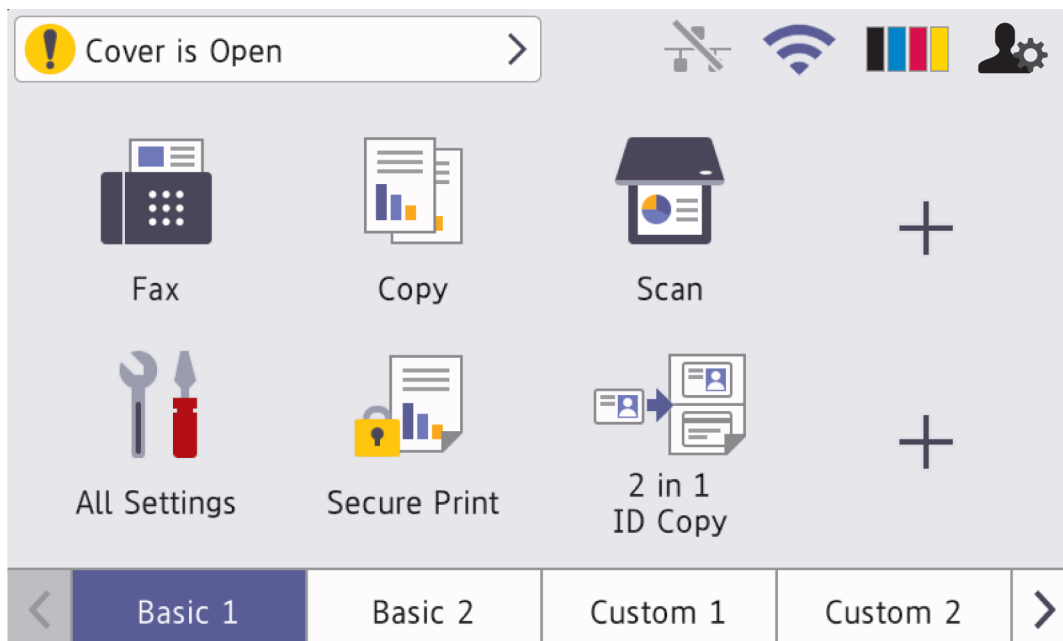

When [Fax Preview] is set to [On], the number of new faxes you received into the memory appears at the top of the screen.

- **Warning icon**



The warning icon  appears when there is an error or maintenance message. Press the message area to view it, and then press  to return to the Main Home screen.

## 2. Touchpanel



Press to go back to the previous menu.

---

 **(Home)**

Press to return to the Main Home screen.

 **(Cancel)**

Press to cancel an operation.



**3. Near Field Communication (NFC) Reader**

You can use card authentication by touching the IC card to the NFC Reader on the control panel.

**4. LED Power Indicator**

The LED lights up depending on the machine's power status.

**5.  Power On/Off**

- Turn the machine on by pressing .
- Turn the machine off by pressing and holding down . The LCD displays [Shutting Down] for a few seconds before it turns off. If you have an external telephone or TAD connected, it is always available even if you turn the machine off.

 **Related Information**

- [Introduction to Your Machine](#)

**Related Topics:**

- [Customisation of Your Machine](#)
-

## How to Navigate the Touchscreen LCD

Press your finger on the LCD to operate it. To display and access all the options, swipe left, right, up, down or press ◀▶ or ▲▼ on the LCD to scroll through them.

### IMPORTANT

DO NOT press the LCD with a sharp object, such as a pen or stylus. It may damage the machine.

### NOTE

DO NOT touch the LCD immediately after plugging in the power cord or turning on the machine. Doing this may cause an error.



This product adopts the font of ARPHIC TECHNOLOGY CO.,LTD.



### Related Information

- [Introduction to Your Machine](#)



## How to Enter Text on Your Machine

- When you must enter text on your machine, a keyboard appears on the LCD.
- The characters that are available may differ depending on your country.
- The keyboard layout may differ depending on the operation you perform.
- The keyboard display may differ depending on your model.



- Press to cycle between letters, numbers and special characters.
- Press to cycle between lowercase and uppercase letters.
- To move the cursor to the left or right, press ◀ or ▶.

### Inserting spaces

- To enter a space, press [Space] or ▶.

### Making corrections

- If you entered a character incorrectly and want to change it, press ◀ or ▶ to move the cursor to the incorrect character, and then press . Enter the correct character.
- To insert a character, press ◀ or ▶ to move the cursor to the correct place, and then enter the character.
- Press for each character you want to erase, or press and hold to erase all the characters.

## ✓ Related Information

- [Introduction to Your Machine](#)

### Related Topics:

- [Configure Your Machine for a Wireless Network Using the Machine's Control Panel Setup Wizard](#)
- [Configure Your Machine for a Wireless Network When the SSID Is Not Broadcast](#)

- 
- Set Your Station ID
-

## Customisation of Your Machine

When you press , the machine displays the [Admin Settings] menu. To restrict access to this menu, set an administrator password to protect it.



- This password is the same as the administrator password for Web Based Management.
- The default password to manage this machine's settings is located on the back of the machine and marked "Pwd".

The [Admin Settings] menu allows you to rename the Home screens and rearrange the icons.

The [Home Screen Settings] menu and the [Other Screen Settings] menu provide the following functions:

- Renaming Home screen tabs
- Adding, removing, and repositioning icons on Home screens
- Setting your Main Home screen
- Selecting screen background colour
- Selecting whether to display your machine's IP Address on the Home screens.
- Changing the default functions for the Copy screen and the Scan screen

The [Admin Settings] menu allows you to manage permissions and restrictions.

The [Restriction Management] menu provides the following functions:

- User Restriction
  - Secure Function Lock
  - Active Directory Authentication
  - LDAP Authentication
- Setting Lock

For more information, see *Related Information. Security and Lock the Machine Settings from the Control Panel.*



### Related Information

- [Introduction to Your Machine](#)

#### Related Topics:

- [Security](#)
- [Lock the Machine Settings from the Control Panel](#)
- [Control Panel Overview](#)

## Access Brother Utilities (Windows)

**Brother Utilities** is an application launcher that offers convenient access to all Brother applications installed on your computer.

1. Do one of the following:

- (Windows 10)

Click  > **Brother** > **Brother Utilities**.

- (Windows 8.1)

Move your mouse to the lower left corner of the **Start** screen and click  (if you are using a touch-based device, swipe up from the bottom of the **Start** screen to bring up the **Apps** screen).

When the **Apps** screen appears, tap or click  (**Brother Utilities**).

- (Windows 7)

Click  (**Start**) > **All Programs** > **Brother** > **Brother Utilities**.

2. Select your machine (where XXXX is the name of your model).

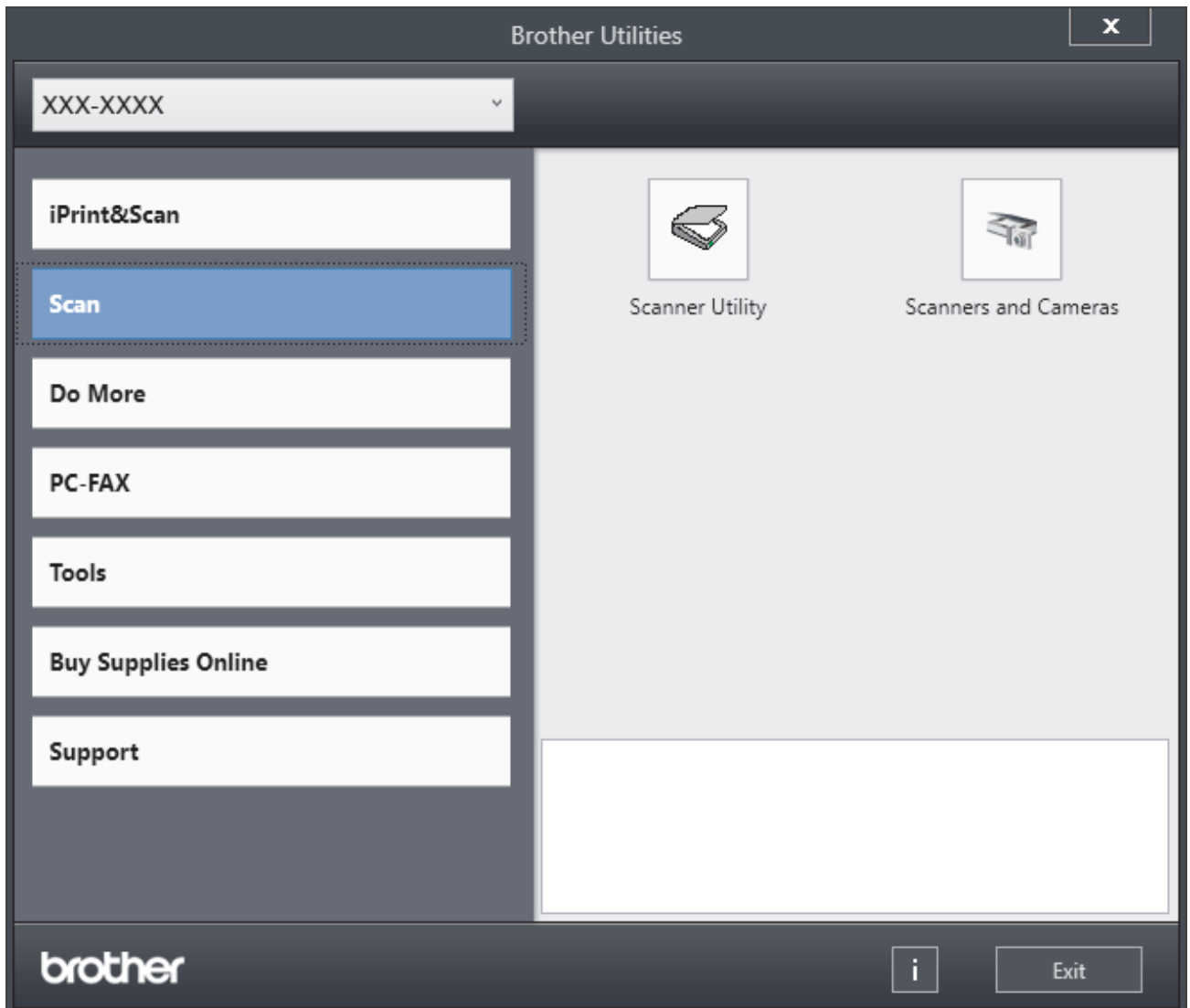

3. Choose the operation you want to use.

### ✓ Related Information

- [Introduction to Your Machine](#)

- 
- Uninstall the Software and Drivers (Windows)
-

## Uninstall the Software and Drivers (Windows)

1. Do one of the following:

- (Windows 10)

Click  > **Brother** > **Brother Utilities**.

- (Windows 8.1)

Move your mouse to the lower left corner of the **Start** screen and click  (if you are using a touch-based device, swipe up from the bottom of the **Start** screen to bring up the **Apps** screen).

When the **Apps** screen appears, tap or click  (**Brother Utilities**).

- (Windows 7)

Click  (**Start**) > **All Programs** > **Brother** > **Brother Utilities**.

2. Select your model from the drop-down list (if it is not already selected).

3. Click **Tools** in the left navigation bar.

- If the **Software Update Notification** icon is visible, select it, and then click **Check now** > **Check for Software Updates** > **Update**. Follow the on-screen instructions.
- If the **Software Update Notification** icon is not visible, go to the next step.

4. Click **Uninstall** in the **Tools** section of **Brother Utilities**.

Follow the instructions in the dialog box to uninstall the software and drivers.



### Related Information

- [Access Brother Utilities \(Windows\)](#)

## The Input/Output Ports on Your Machine

The input/output ports are located on the back and front of the machine.

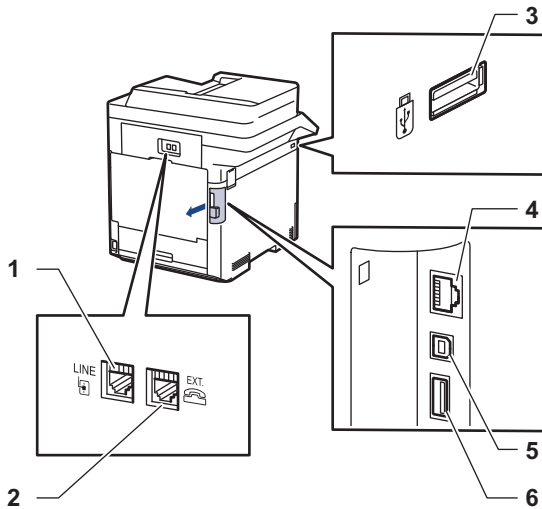

1. LINE jack (For MFC models)
2. EXT. jack (For MFC models)
3. USB accessory port (Front)
4. LAN port (For Network models)
5. USB port
6. USB accessory port (Rear)

When connecting the USB or Ethernet cable, follow the instructions in the software/driver installer.

To install the driver and software necessary for operating your machine, go to your model's **Downloads** page at [support.brother.com](http://support.brother.com).

### ✓ Related Information

- [Introduction to Your Machine](#)

#### Related Topics:

- [Secure Print Using a USB Flash Drive](#)

## Paper Handling

- [Load Paper](#)
- [Paper Settings](#)
- [Change the Tray Size for 2-sided Printing](#)
- [Recommended Print Media](#)
- [Load Documents](#)
- [Unscannable and Unprintable Areas](#)
- [Using Special Paper](#)



## Load Paper

- [Load and Print Using the Paper Tray](#)
- [Load and Print Using the Multi-purpose Tray \(MP Tray\)](#)

## Load and Print Using the Paper Tray

- [Load Paper in the Paper Tray](#)
- [Printing Problems](#)
- [Error and Maintenance Messages](#)

## Load Paper in the Paper Tray

- If the Check Paper setting is set to On and you pull the paper tray out of the machine, a message appears on the LCD asking if you want to change the paper size and paper type. Change the paper size and paper type settings if needed, following the LCD instructions.
- When you load a different size and type of paper in the tray, you must also change the Paper Size and Paper Type settings in the machine, or on your computer.

1. Pull the paper tray completely out of the machine.

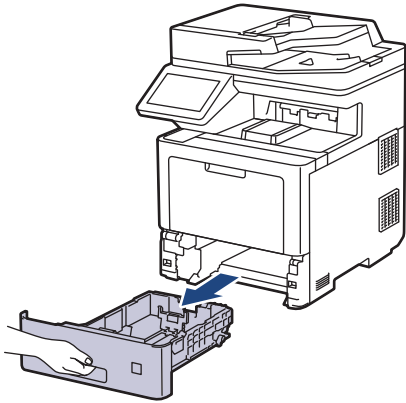

2. Press the green levers to slide the paper guides to fit the paper.

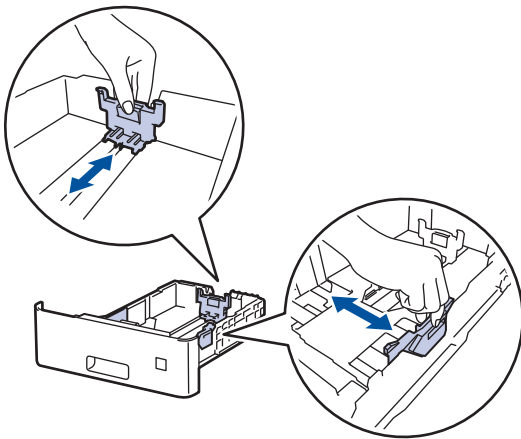

3. Fan the stack of paper well.
4. Load paper in the paper tray with the printing surface *face down*.



When you use letterhead or preprinted paper, load the paper in the correct orientation. See *Related Information: Change Machine Settings to Print on Letterhead or Preprinted Paper Using the Paper Tray*.

- 
5. Make sure the paper is below the maximum paper mark (▼▼▼).

Overfilling the paper tray will cause paper jams.

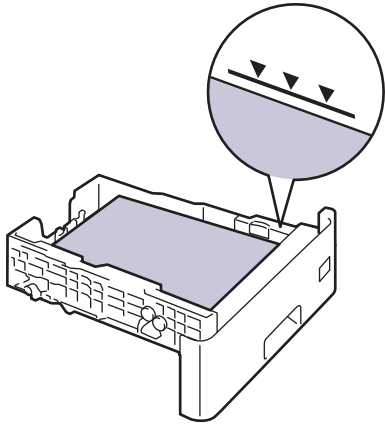

6. Slowly push the paper tray completely into the machine.
7. Push the support flap to open it to prevent paper from sliding off the face down output tray.

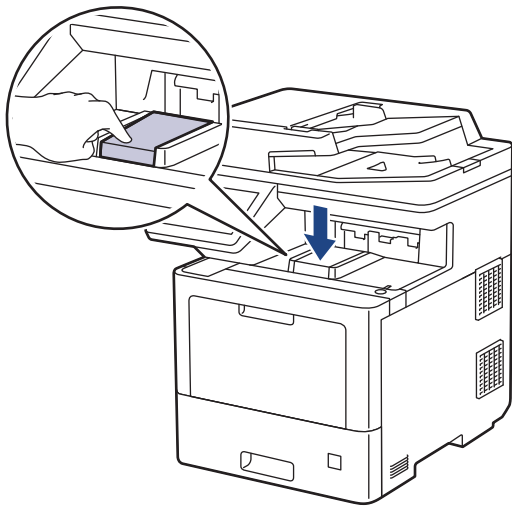

### Related Information

- [Load and Print Using the Paper Tray](#)
  - [Change Machine Settings to Print on Letterhead or Preprinted Paper Using the Paper Tray](#)
-

## Change Machine Settings to Print on Letterhead or Preprinted Paper Using the Paper Tray

When you use letterhead or preprinted paper for 2-sided printing, change the machine's settings.



- DO NOT load different sizes and types of paper in the paper tray at the same time. Doing this may cause the paper to jam or misfeed.
- If the print position is misaligned with the letterhead or preprinted objects, the print position is adjustable using the Print Position setting for the paper tray.
- Some preprinted paper may cause print stains, depending on the printing method and ink type.

### Orientation

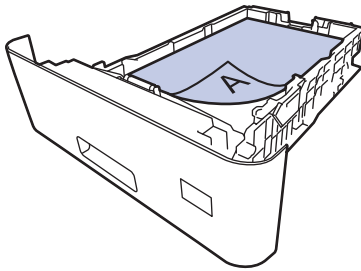
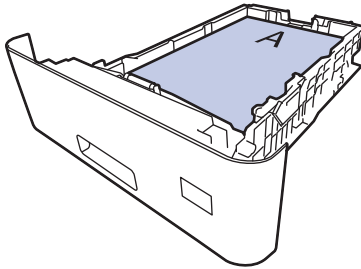
|  |  |
|--|--|
|   | For 1-sided printing <ul style="list-style-type: none"><li>• face down</li><li>• top edge towards the front of the paper tray</li></ul>                                |
|  | For automatic 2-sided printing (long edge binding) <ul style="list-style-type: none"><li>• face up</li><li>• bottom edge towards the front of the paper tray</li></ul> |

1. Press  [Settings] > [All Settings] > [Printer] > [2-sided] > [Single Image] > [2-sided Feed].



If your machine displays the [All Settings] menu on the Home screen, skip the [Settings] menu.

2. Press .



### Related Information

- [Load Paper in the Paper Tray](#)

## Load and Print Using the Multi-purpose Tray (MP Tray)

You can load thin paper, thick paper, recycled paper, bond paper, glossy paper, letterhead, coloured paper, labels, up to 100 sheets of plain paper, or up to 15 envelopes in the MP tray.

- [Load Paper in the Multi-purpose Tray \(MP Tray\)](#)
- [Load and Print Labels Using the MP Tray](#)
- [Load and Print Envelopes Using the MP Tray](#)
- [Printing Problems](#)
- [Error and Maintenance Messages](#)

## Load Paper in the Multi-purpose Tray (MP Tray)

When you load a different size and type of paper in the tray, you must also change the Paper Size and Paper Type settings in the machine, or on your computer.

- Plain Paper
- Thin Paper
- Thick Paper
- Recycled Paper
- Bond Paper
- Glossy Paper
- Letterhead
- Coloured Paper

1. Push the support flap to open it to prevent paper from sliding off the face down output tray.

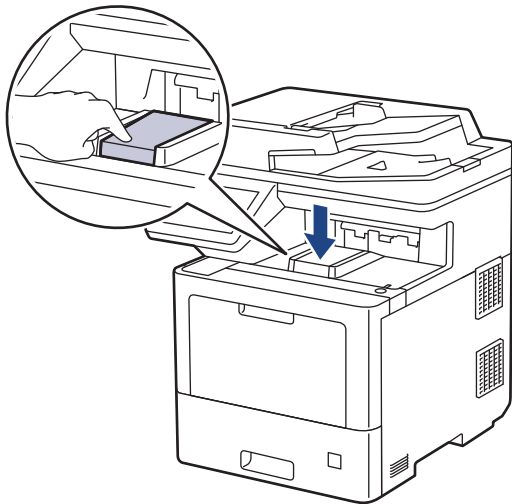

2. Open the MP tray and lower it gently.

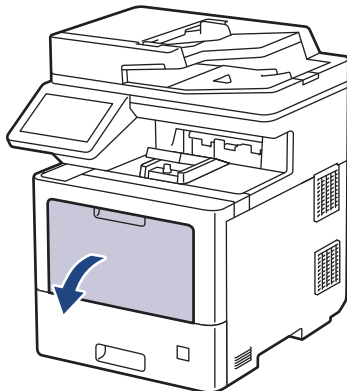

- 
3. Pull out the MP tray support (1) and unfold the flap (2).

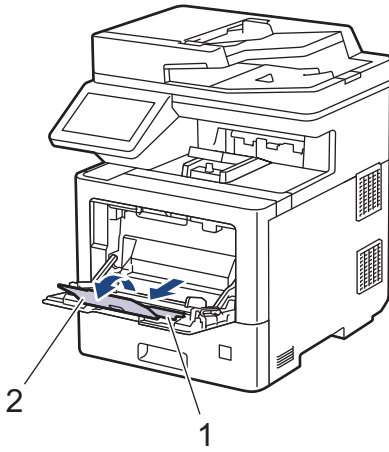

4. Slide the MP tray paper guides to fit the width of the paper you are using.

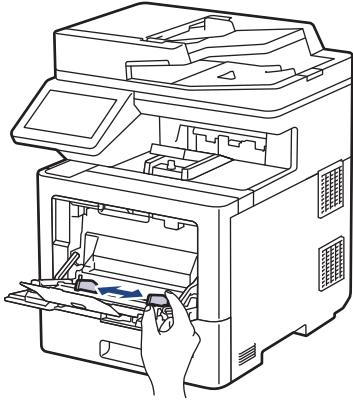

5. Load paper with the printing surface *face up* in the MP tray.

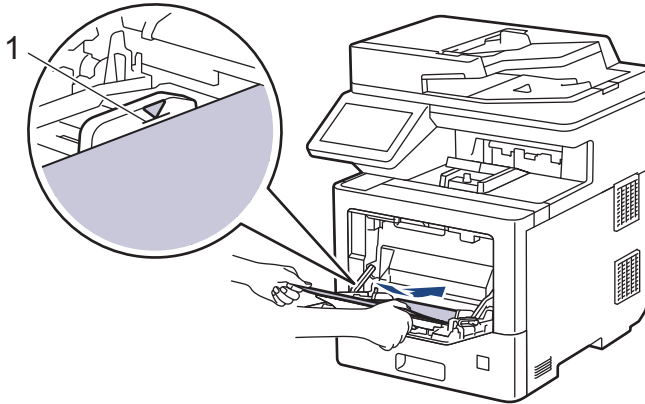

- Make sure the paper is below the maximum paper mark (1).
- When using glossy paper, load only one sheet at a time in the MP tray to avoid a paper jam.
- When you use letterhead or preprinted paper, load the paper in the correct orientation. See *Related Information: Change Machine Settings to Print on Letterhead or Preprinted Paper Using the MP Tray*.



### Related Information

- [Load and Print Using the Multi-purpose Tray \(MP Tray\)](#)
  - [Change Machine Settings to Print on Letterhead or Preprinted Paper Using the MP Tray](#)



## Change Machine Settings to Print on Letterhead or Preprinted Paper Using the MP Tray

When you use letterhead or preprinted paper for 2-sided printing, change the machine's settings.



- DO NOT load different sizes and types of paper in the paper tray at the same time. Doing this may cause the paper to jam or misfeed.
- If the print position is misaligned with the letterhead or preprinted objects, the print position is adjustable using the Print Position setting for the MP tray.
- Print stains may occur when using some preprinted paper depending on the printing method and ink.

### Orientation

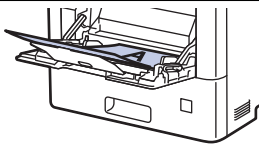
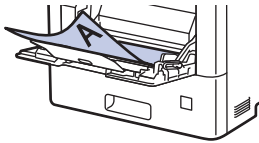
|  |  |
|--|--|
|   | For 1-sided printing <ul style="list-style-type: none"><li>• face up</li><li>• top edge first</li></ul>                                    |
|  | For automatic 2-sided printing (long edge binding) <ul style="list-style-type: none"><li>• face down</li><li>• bottom edge first</li></ul> |

1. Press  [Settings] > [All Settings] > [Printer] > [2-sided] > [Single Image] > [2-sided Feed].



If your machine displays the [All Settings] menu on the Home screen, skip the [Settings] menu.

2. Press .



### Related Information

- [Load Paper in the Multi-purpose Tray \(MP Tray\)](#)

## Load and Print Labels Using the MP Tray

When you print on labels, open the back cover (the face up output tray) and use the MP tray.

When you load a different size and type of paper in the tray, you must also change the Paper Size and Paper Type settings in the machine, or on your computer.

1. Open the machine's back cover (the face up output tray).

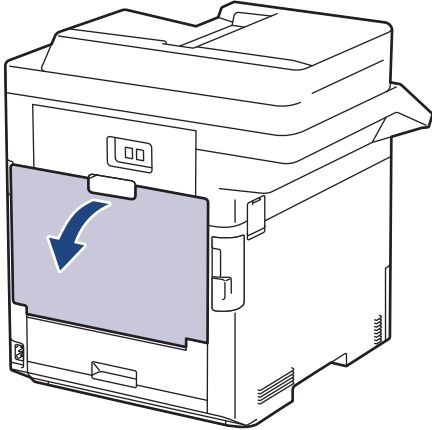

2. On the front of the machine, open the MP tray and lower it gently.

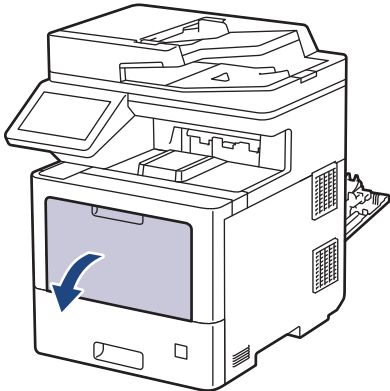

3. Pull out the MP tray support (1) and unfold the flap (2).

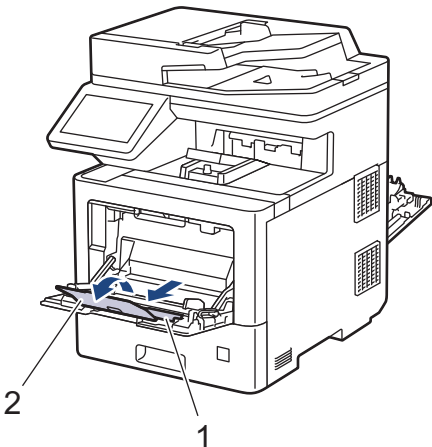

- 
- Slide the MP tray paper guides to fit the width of the labels you are using.

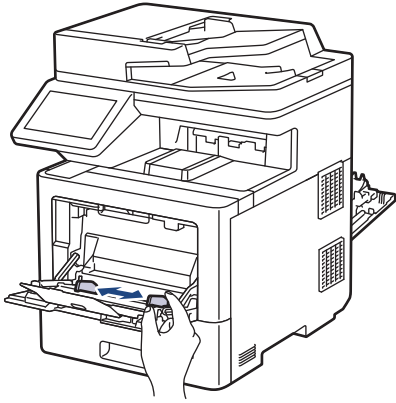

- Load the labels with the printing surface *face up* in the MP tray.

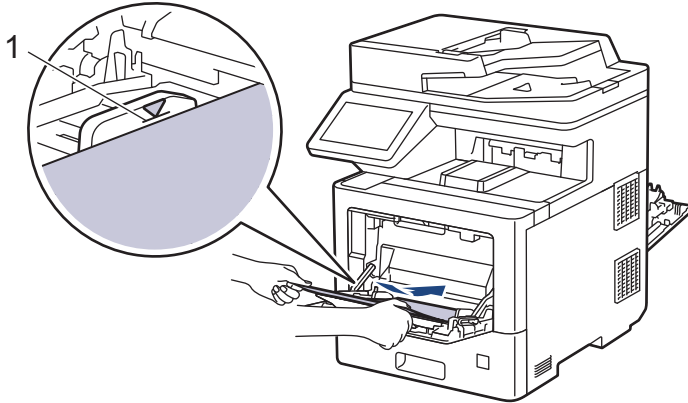

Make sure the labels are below the maximum paper mark (1).

- Change your print preferences in the Print screen.
- Send your print job to the machine.
- After the machine prints, close the back cover (the face up output tray) until it locks in the closed position.



### Related Information

- [Load and Print Using the Multi-purpose Tray \(MP Tray\)](#)
-

## Load and Print Envelopes Using the MP Tray

You can load up to 15 envelopes in the MP tray.

Before loading, press the corners and sides of the envelopes to make them as flat as possible.

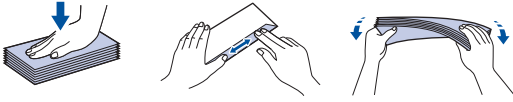

When you load a different size and type of paper in the tray, you must also change the Paper Size and Paper Type settings in the machine, or on your computer.

1. Open the machine's back cover (the face up output tray).

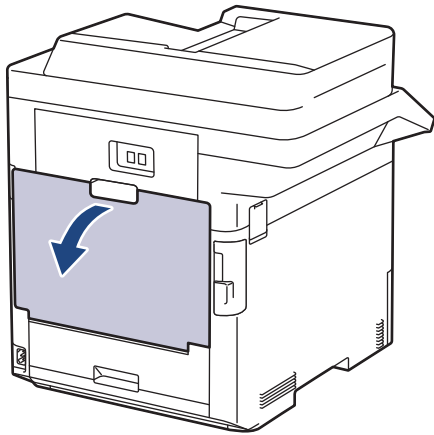

2. On the front of the machine, open the MP tray and lower it gently.

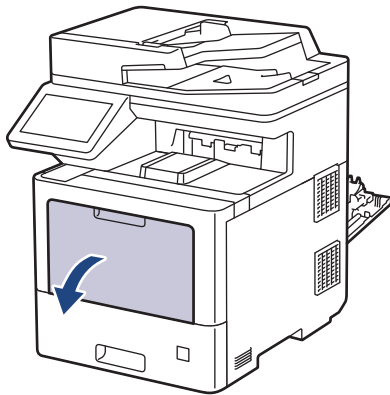

3. Pull out the MP tray support (1) and unfold the flap (2).

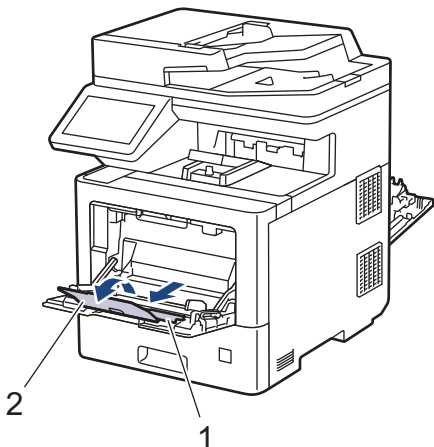

- 
4. Slide the MP tray paper guides to fit the width of the envelopes that you are using.

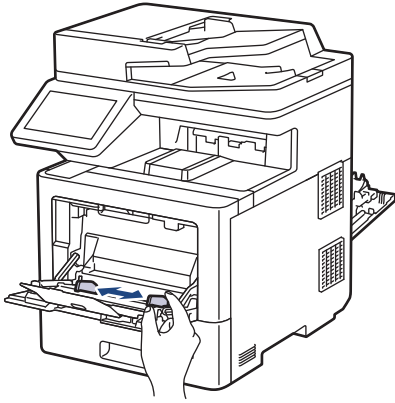

5. Load the envelopes with the printing surface *face up* in the MP tray.

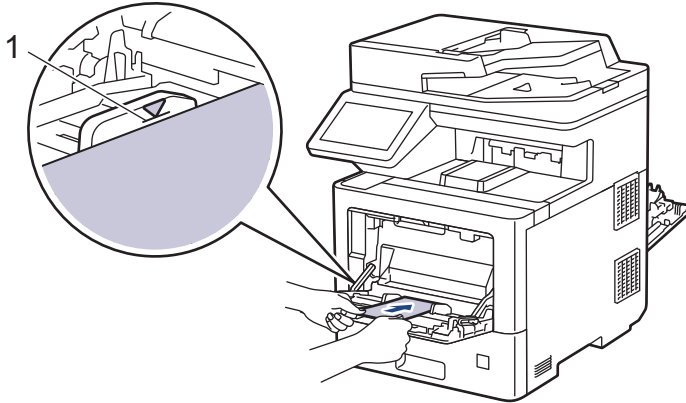

---

Load up to 15 envelopes in the MP tray with the printing surface face up. Make sure the envelopes are below the maximum paper mark (1). Loading more than 15 envelopes may cause paper jams.

---

6. Change your print preferences in the Print dialog.

| Settings   | Options for Envelopes                |
|------------|--------------------------------------|
| Paper Size | Com-10<br>DL<br>C5<br>Monarch        |
| Media Type | Envelopes<br>Env. Thick<br>Env. Thin |

7. Send your print job to the machine.  
8. After the machine prints, close the back cover (the face up output tray) until it locks in the closed position.



### Related Information

- [Load and Print Using the Multi-purpose Tray \(MP Tray\)](#)
-

## Paper Settings

- [Change the Paper Size and Paper Type](#)
- [Select the Paper Tray For Printing](#)
- [Change the Check Paper Setting](#)



## Change the Paper Size and Paper Type

When you change the size and type of the paper you load in the tray, you must also change the Paper Size and Paper Type settings on the LCD.

1. Press  [Settings] > [All Settings] > [General Setup] > [Tray Setting] > [Paper Type].



If your machine displays the [All Settings] menu on the Home screen, skip the [Settings] menu.

2. Press the option you want.
3. Swipe up or down or press ▲ or ▼ to display the paper type options, and then press the option you want.
4. Press .
5. Press [Paper Size].
6. Press the option you want.
7. Swipe up or down or press ▲ or ▼ to display the paper size options, and then press the option you want.
8. Press .



### Related Information

- [Paper Settings](#)

## Select the Paper Tray For Printing

Change the machine's default paper tray for printing copies, received faxes, and print jobs from your computer.

1. Press  [Settings] > [All Settings] > [General Setup] > [Tray Setting].



If your machine displays the [All Settings] menu on the Home screen, skip the [Settings] menu.

2. Swipe up or down or press ▲ or ▼ to display the [Tray Use: Copy], [Tray Use: Fax], or [Tray Use: Print] option, and then press the option you want.
3. Swipe up or down or press ▲ or ▼ to display the option you want, and then press it. For example, when you select the [MP>T1] option, the machine pulls paper from the MP tray until it is empty, and then from Tray 1.
4. Press .



- When you make a copy using the ADF and give priority to multiple trays, the machine looks for the tray with the most suitable paper and pulls paper from that tray.
- When you make a copy using the scanner glass, your document is copied from the higher priority tray even if more suitable paper is in another paper tray.
- Use the following sizes of paper for printing faxes: Letter, A4, Legal, Folio, Mexico Legal, or India Legal. When an appropriate size is not in any of the trays, the machine stores received faxes and [Size Mismatch] appears on the touchscreen.
- If the tray is out of paper and received faxes are in the machine's memory, [No Paper] appears on the touchscreen. Load paper in the empty tray.



### Related Information

- [Paper Settings](#)



## Change the Check Paper Setting

When you turn on your machine's Check Paper setting, the machine displays a message when you remove a paper tray or load paper using the MP tray, asking if you changed the paper size and paper type.

The default setting is On.

1. Press  [Settings] > [All Settings] > [General Setup] > [Tray Setting] > [Check Paper].



If your machine displays the [All Settings] menu on the Home screen, skip the [Settings] menu.

2. Press [On] or [Off].
3. Press .



### Related Information

- [Paper Settings](#)

## Change the Tray Size for 2-sided Printing

When you print on both sides of the paper, you must set the 2-sided tray size to the paper size. If you do not set the 2-sided tray, the paper will not feed correctly, resulting in a skewed printout or a paper jam.

This feature is not available in some countries.

1. Slide the lever on the 2-sided tray to the correct paper size.

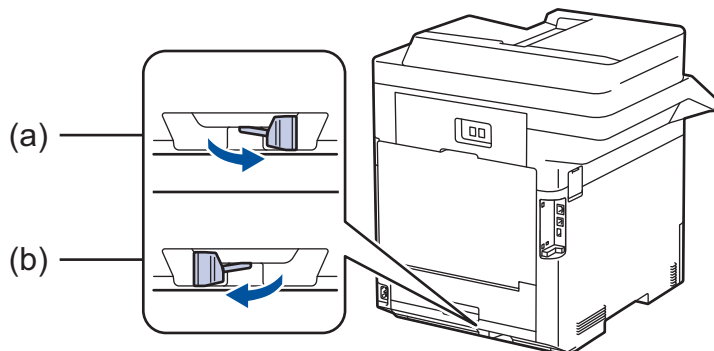

- a. A4 (for A4)
- b. Letter (for Letter, Legal, Mexico Legal, India Legal, and Folio)



### Related Information

- [Paper Handling](#)

## Recommended Print Media

To get the best print quality, we recommend using the paper listed in the table.

| Paper Type     | Item  |
|----------------|---|
| Plain Paper    | Xerox Premier TCF 80 g/m <sup>2</sup>               |
|                | Xerox Business 80 g/m <sup>2</sup>                  |
| Recycled Paper | Steinbeis Evolution White 80 g/m <sup>2</sup>       |
| Labels         | Avery laser label L7163                             |
| Envelopes      | Antalis River series (DL)                           |
| Glossy Paper   | Mondi Color Copy Coated Glossy 135 g/m <sup>2</sup> |



### Related Information

- [Paper Handling](#)

## Load Documents

You can send a fax, make copies and scan from the Automatic Document Feeder (ADF) and from the scanner glass.

- [Load Documents in the Automatic Document Feeder \(ADF\)](#)
- [Load Documents on the Scanner Glass](#)

## Load Documents in the Automatic Document Feeder (ADF)

Use the ADF when copying or scanning multiple-page, standard-sized documents.

- The ADF can hold up to 100 sheets and feed each sheet individually.
- Use standard 80 g/m<sup>2</sup> paper.
- Make sure documents with correction fluid or written in ink are completely dry.

### IMPORTANT

- DO NOT leave thick documents on the scanner glass. If you do this, the ADF may jam.
- DO NOT use paper that is curled, wrinkled, folded, ripped, stapled, paper-clipped, pasted, or taped.
- DO NOT use cardboard, newspaper, or fabric.
- To avoid damaging your machine while using the ADF, DO NOT pull on the document while it is feeding.

### Document Sizes Supported

|         |                            |
|---------|----------------------------|
| Length: | 147.3 to 355.6 mm          |
| Width:  | 105 to 215.9 mm            |
| Weight: | 45 to 120 g/m <sup>2</sup> |

1. Unfold the ADF document output support flap.

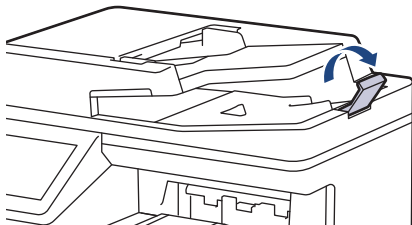

2. Fan the pages well.
3. Stagger the pages of your document and load it *face up* and *top edge first*, into the ADF as shown in the illustration.

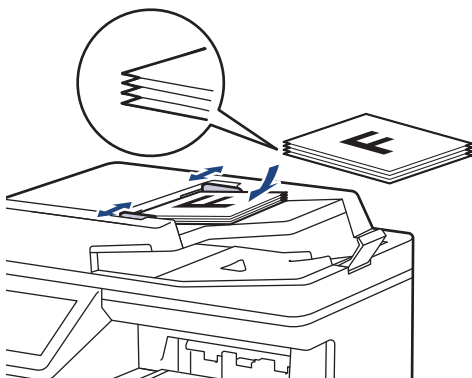

4. Adjust the paper guides to fit the width of your document.



### Related Information

- [Load Documents](#)

## Load Documents on the Scanner Glass

Use the scanner glass to fax, copy, or scan one page at a time.

### Document Sizes Supported

|         |                |
|---------|----------------|
| Length: | Up to 355.6 mm |
| Width:  | Up to 215.9 mm |
| Weight: | Up to 2kg      |



To use the scanner glass, the ADF must be empty.

1. Lift the document cover.
2. Place the document on the scanner glass *face down*.

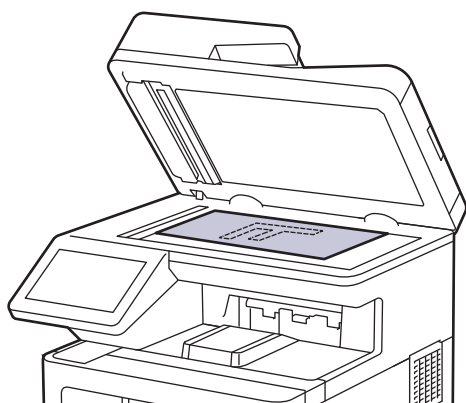

3. Place the corner of the page in the upper left corner of the scanner glass.

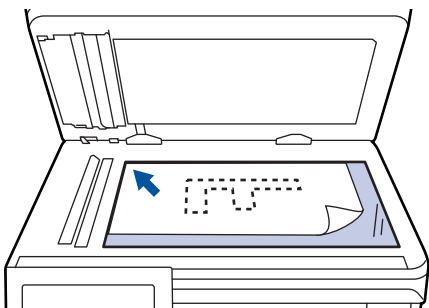

4. Close the document cover.  
If the document is a book or is thick, gently press on the document cover.



### Related Information

- [Load Documents](#)

## Unscannable and Unprintable Areas

The measurements in the table below show maximum unscannable and unprintable areas from the edges of the most commonly-used paper sizes. These measurements may vary depending on the paper size or settings in the application you are using.

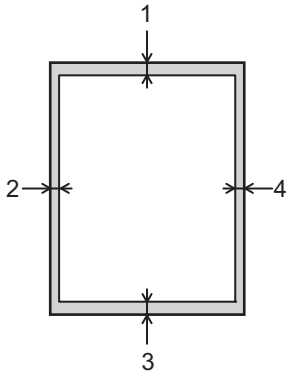

Do not attempt to scan, copy, or print into these areas; your output will not reflect anything in these areas.

| Usage             | Document Size | Top (1)<br>Bottom (3) | Left (2)<br>Right (4)                        |
|-------------------|---------------|-----------------------|--|
| Fax (Sending)     | Letter, Legal | 2.9 mm                | 3.9 mm                                       |
|                   | A4            | 2.9 mm                | (ADF)<br>1.0 mm<br>(Scanner Glass)<br>3.0 mm |
| Copy <sup>1</sup> | Letter, Legal | 4.0 mm                | 4.0 mm                                       |
|                   | A4            | 4.0 mm                | 3.0 mm                                       |
| Scan              | Letter        | 1.0 mm <sup>2</sup>   | 1.0 mm <sup>2</sup>                          |
|                   | A4            | 1.0 mm <sup>2</sup>   | 1.0 mm <sup>2</sup>                          |
|                   | Legal         | 1.0 mm <sup>2</sup>   | 1.0 mm <sup>2</sup>                          |
| Print             | Letter, Legal | 4.2 mm                | 4.2 mm                                       |
|                   | A4            | 4.2 mm                | 4.2 mm                                       |

<sup>1</sup> A 1 in 1 copy and 100% document size copy

<sup>2</sup> The number shown is the default value. This number is adjustable to 0 mm. If the number is set to 0 mm, a black shadow may appear around the edges on the scanned image.



### Related Information

- [Paper Handling](#)

## Using Special Paper

Always test paper samples before purchasing them to ensure desirable performance.

- DO NOT use inkjet paper; it may cause a paper jam or damage your machine.
- If you use bond paper, paper with a rough surface, or paper that is wrinkled or creased, the paper may exhibit degraded performance.

Store paper in its original packaging and keep it sealed. Keep the paper flat and away from moisture, direct sunlight, and heat.

### IMPORTANT

Some types of paper may not perform well or may cause damage to your machine.

DO NOT use paper:

- that is highly textured
- that is extremely smooth or shiny
- that is curled or warped
- that is coated or has a chemical finish
- that is damaged, creased, or folded
- that exceeds the recommended weight specification in this guide
- with tabs and staples
- with letterhead using low temperature dyes or thermography
- that is multipart or carbonless
- that is designed for inkjet printing

If you use any of the types of paper listed above, they may damage your machine. This damage is not covered under any Brother warranty or service agreement.



### Related Information

- [Paper Handling](#)



## Print

- [Print from Your Computer \(Windows\)](#)
- [Print from Your Computer \(Mac\)](#)
- [Secure Print Using a USB Flash Drive](#)
- [Print Data Directly from a USB Flash Drive](#)
- [Print Duplicate Copies](#)
- [Cancel a Print Job](#)
- [Test Print](#)

## Print from Your Computer (Windows)

- [Print a Document \(Windows\)](#)
- [Print Settings \(Windows\)](#)
- [Secure Print \(Windows\)](#)
- [Change the Default Print Settings \(Windows\)](#)
- [Print a Document Using the BR-Script3 Printer Driver \(PostScript® 3™ Language Emulation\) \(Windows\)](#)
- [Monitor the Status of the Machine from Your Computer \(Windows\)](#)

## Print a Document (Windows)

1. Select the print command in your application.
2. Select **Brother XXX-XXXX** (where XXXX is the name of your model), and then click the printing properties or preferences button.

The printer driver window appears.

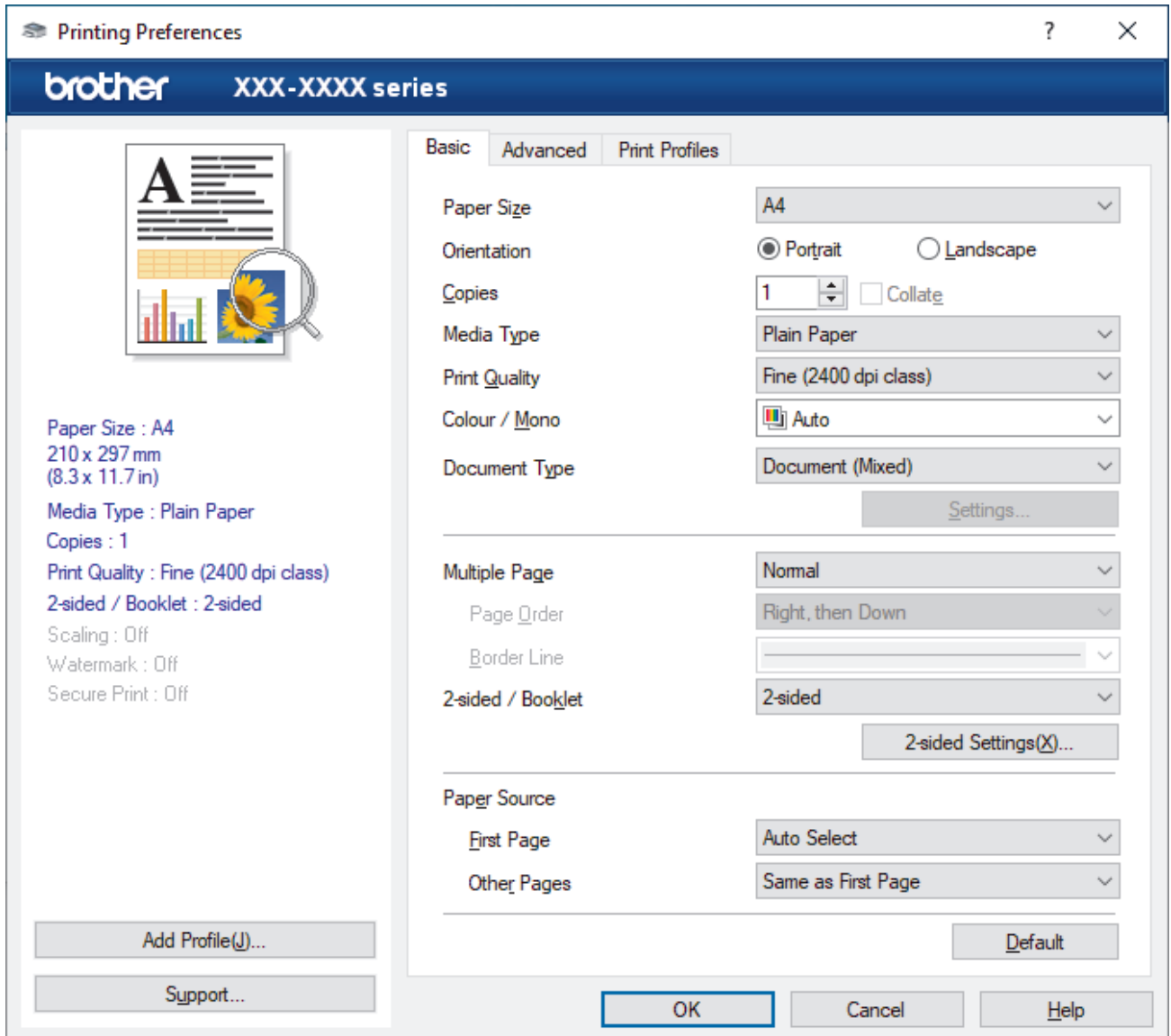

3. Make sure you have loaded the correct size paper in the paper tray.
4. Click the **Paper Size** drop-down list, and then select your paper size.
5. In the **Orientation** field, select the **Portrait** or **Landscape** option to set the orientation of your printout.



If your application contains a similar setting, we recommend that you set the orientation using the application.

6. Type the number of copies (1-999) you want in the **Copies** field.
7. Click the **Media Type** drop-down list, and then select the type of paper you are using.
8. To print multiple pages on a single sheet of paper or print one page of your document on multiple sheets, click the **Multiple Page** drop-down list, and then select your options.
9. Change other printer settings, if needed.
10. Click **OK**.
11. Complete your print operation.



---

## Related Information

---

- [Print from Your Computer \(Windows\)](#)

### **Related Topics:**

- [Print Settings \(Windows\)](#)
-

## Print Settings (Windows)

>> [Basic Tab](#)

>> [Advanced Tab](#)

### Basic Tab

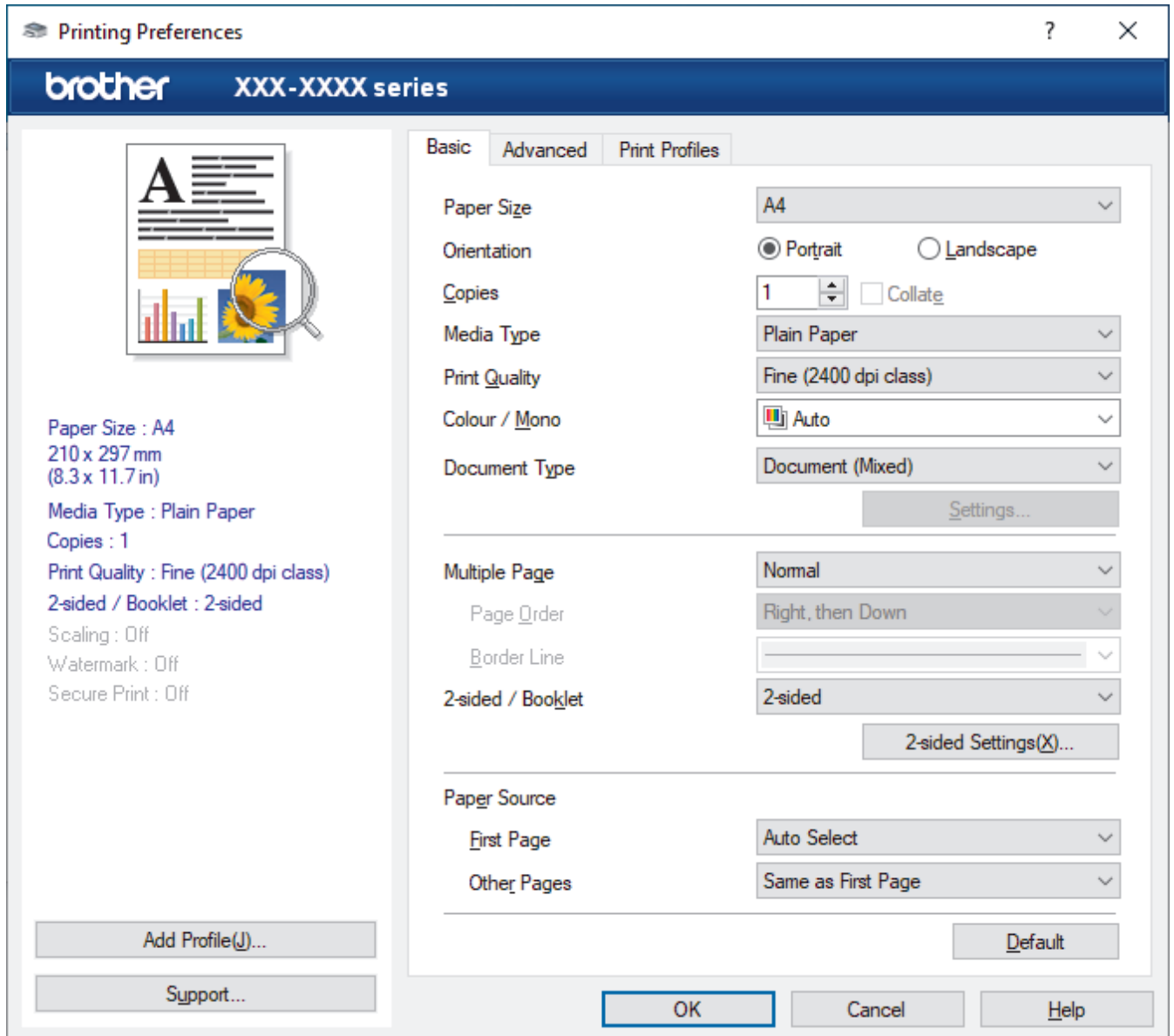

#### 1. Paper Size

Select the paper size you want to use. You can either choose from standard paper sizes or create a custom paper size.

#### 2. Orientation

Select the orientation (portrait or landscape) of your printout.

If your application contains a similar setting, we recommend that you set the orientation using the application.

#### 3. Copies

Type the number of copies (1-999) that you want to print in this field.

#### Collate

Select this option to print sets of multi-page documents in the original page order. When this option is selected, one complete copy of your document will print, and then reprint according to the number of

---

copies you choose. If this option is not selected, then each page will print according to the number of copies chosen before the next page of the document is printed.

#### 4. Media Type

Select the media type you want to use. To achieve the best print results, the machine automatically adjusts its print settings according to the selected media type.

#### 5. Print Quality

Select the print quality you want. Because print quality and speed are related, the higher the quality, the longer it will take to print the document.

#### 6. Colour / Mono

Select the Colour/Mono settings to use.

### NOTE

- The machine's colour sensor is very sensitive and may perceive faded black text or an off-white background as colour. If you know that your document is black and white and you want to conserve colour toner, select the **Mono** mode.
- If either the Cyan, Magenta, or Yellow toner reaches the end of its life while printing a colour document, the print job cannot be completed. Cancel your print job and select to start the print job again in **Mono** mode, as long as the Black toner is available.

---

#### 7. Document Type

Select the type of document you want to print.

##### Settings button

Specify advanced settings, such as colour mode.

##### Colour Mode

Select the colour mode to suit your preference.

##### Import

To adjust the print configuration of a particular image, click **Settings**. When you have finished adjusting the image parameters, such as brightness and contrast, import those settings as a print configuration file. Use the **Export** option to create a print configuration file from the current settings.

##### Export

To adjust the print configuration of a particular image, click **Settings**. When you have finished adjusting the image parameters, such as brightness and contrast, export those settings as a print configuration file. Use the **Import** option to load a previously exported configuration file.

##### Improve Grey Colour

Select this option to improve the image quality of shaded areas.

##### Enhance Black Printing

If a black graphic does not print correctly, select this setting.

##### Improve Pattern Printing

Select this option to improve the pattern printing if printed fills and patterns are different from the fills and patterns you see on your computer screen.

#### 8. Multiple Page

Select this option to print multiple pages on a single sheet of paper, or print one page of your document on multiple sheets.

##### Page Order

Select the page order when printing multiple pages on a single sheet of paper.

##### Border Line

Select the type of border to use when printing multiple pages on a single sheet of paper.

## 9. 2-sided / Booklet (available only for certain models)

Select this option to print on both sides of the paper, or print a document in booklet format using 2-sided printing.

### 2-sided Settings button

Click this button to select the type of 2-sided binding. Four types of 2-sided bindings are available for each orientation.

## 10. Paper Source

Select the paper source setting according to your print conditions or purpose.

### First Page

Select the paper source to use for printing the first page.

### Other Pages

Select the paper source to use for printing the second and subsequent pages.

## Advanced Tab

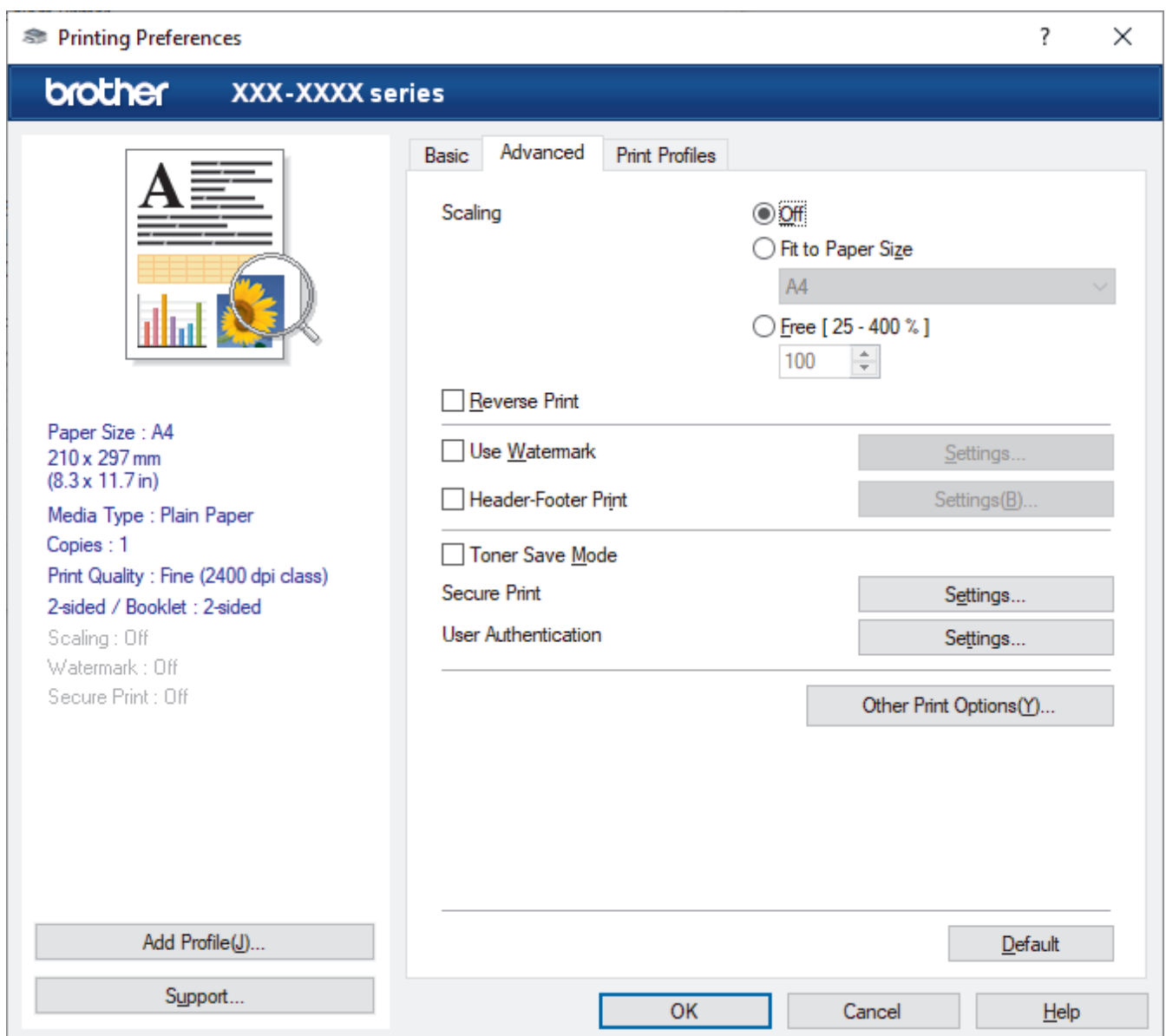

### 1. Scaling

Select these options to enlarge or reduce the size of the pages in your document.

---

### **Fit to Paper Size**

Select this option to enlarge or reduce the document pages to fit a specified paper size. When you select this option, select the paper size you want from the drop-down list.

### **Free [25 - 400%]**

Select this option to enlarge or reduce the document pages manually. When you select this option, type a value into the field.

### **2. Reverse Print**

Select this option to rotate the printed image 180 degrees.

### **3. Use Watermark**

Select this option to print a logo or text on your document as a watermark. Select one of the preset watermarks, add a new watermark, or use an image file you have created.

### **4. Header-Footer Print**

Select this option to print the date, time, and login user name on the document.

### **5. Toner Save Mode**

Select this feature to conserve toner by using less toner to print documents; printouts appear lighter, but are still legible.

### **6. Secure Print**

This feature ensures that confidential or sensitive documents do not print until you enter a password on the machine's control panel.

### **7. Administrator**

This feature allows you to change the administrator password and restrict various printing functions.

### **8. User Authentication**

This feature allows you to confirm the restrictions for each user.

### **9. Other Print Options button**

#### **Sleep Time**

Select this option to set the machine to enter sleep mode immediately after printing.

#### **Macro/Stream**

Select this feature to print an electronic form (macro/stream), which you have stored in your machine's memory, as an overlay on the print job.

#### **Improve Print Output**

Select this option to reduce the amount of paper curling and improve the toner fixing.

#### **Skip Blank Page**

Select this option to allow the printer driver to automatically detect blank pages and exclude them from printing.

#### **TrueType Mode**

##### **Mode**

Select how the fonts are processed for printing.

##### **Use Printer TrueType Fonts(available only for certain models)**

Select whether to use built-in fonts for the font processing.

#### **Eco settings**

Select this option to reduce printing noise.



## **Related Information**

- [Print from Your Computer \(Windows\)](#)



---

**Related Topics:**

- [Print a Document \(Windows\)](#)
-

## Secure Print (Windows)

Use Secure Print to ensure that confidential or sensitive documents do not print until you enter a password on the machine's control panel.

The secure data is deleted from the machine when you turn the machine off.

1. Select the print command in your application.
2. Select **Brother XXX-XXXX** (where XXX-XXXX is the name of your model), and then click the printing properties or preferences button.  
The printer driver window appears.
3. Click the **Advanced** tab.
4. Click the **Settings** button in the **Secure Print** field.
5. Select the **Secure Print** checkbox.
6. Type your four-digit password in the **Password** field.
7. Type the **User Name** and **Job Name** in the text field, if needed.
8. Click **OK**, to close the **Secure Print Settings** window.
9. Click **OK**.
10. Complete your print operation.
11. On the machine's control panel, swipe left or right or press ◀ or ▶ to display the [Secure Print] option, and then press [Secure Print].
12. Swipe up or down or press ▲ or ▼ to display user names, and then press your user name.
13. Enter your four-digit password, and then press [OK].
14. Swipe up or down or press ▲ or ▼ to display the print job, and then press it.
15. Enter the number of copies you want, and then press [OK].
16. Press [Start].

After you have printed the secured data, it will be cleared from the machine's memory.





### Related Information

- [Print from Your Computer \(Windows\)](#)

## Change the Default Print Settings (Windows)

When you change an application's print settings, the changes only apply to documents printed with that application. To change print settings for all Windows applications, you must configure the printer driver properties.

- Do one of the following:
  - For Windows 10, Windows Server 2016 and Windows Server 2019  
Click  > **Windows System** > **Control Panel**. In the **Hardware and Sound** group, click **View devices and printers**.
  - For Windows 8.1  
Move your mouse to the lower right corner of your desktop. When the menu bar appears, click **Settings**, and then click **Control Panel**. In the **Hardware and Sound** group, click **View devices and printers**.
  - For Windows Server 2012 R2  
Click **Control Panel** on the **Start** screen. In the **Hardware** group, click **View devices and printers**.
  - For Windows Server 2012  
Move your mouse to the lower right corner of your desktop. When the menu bar appears, click **Settings**, and then click **Control Panel**. In the **Hardware** group, click **View devices and printers**.
  - For Windows 7 and Windows Server 2008 R2  
Click  (**Start**) > **Devices and Printers**.
  - For Windows Server 2008  
Click  (**Start**) > **Control Panel** > **Hardware and Sound** > **Printers**.
- Right-click the **Brother XXX-XXXX** icon (where XXX-XXXX is the name of your model), and then select **Printer properties**. If printer driver options appear, select your printer driver.  
The printer properties dialog box appears.
- Click the **General** tab, and then click the **Printing Preferences...** or **Preferences...** button.  
The printer driver dialog box appears.  

---

  - To configure the tray settings, click the **Device Settings** tab (available only for certain models).
  - To change the printer port, click the **Ports** tab.

---
- Select the print settings you want to use as defaults for all of your Windows programs.
- Click **OK**.
- Close the printer properties dialog box.





### Related Information

- [Print from Your Computer \(Windows\)](#)
  - [Configure the Optional Tray Settings \(Windows\)](#)

## Configure the Optional Tray Settings (Windows)

Access your machine's Properties to auto-detect your machine's Optional Tray and check the machine's serial number.

The printer driver automatically detects the Optional Tray during the driver installation. If you added the Optional Tray after the driver installation, follow these steps:

1. Do one of the following:
  - For Windows 10, Windows Server 2016, and Windows Server 2019  
Click  > **Windows System** > **Control Panel**. In the **Hardware and Sound** group, click **View devices and printers**.
  - For Windows 8.1  
Move your mouse to the lower right corner of your desktop. When the menu bar appears, click **Settings**, and then click **Control Panel**. In the **Hardware and Sound** group, click **View devices and printers**.
  - For Windows Server 2012 R2  
Click **Control Panel** on the **Start** screen. In the **Hardware** group, click **View devices and printers**.
  - For Windows Server 2012  
Move your mouse to the lower right corner of your desktop. When the menu bar appears, click **Settings**, and then click **Control Panel**. In the **Hardware** group, click **View devices and printers**.
  - For Windows 7 and Windows Server 2008 R2  
Click  (**Start**) > **Devices and Printers**.
  - For Windows Server 2008  
Click  (**Start**) > **Control Panel** > **Hardware and Sound** > **Printers**.
2. Right-click the **Brother XXX-XXXX** icon (where XXX-XXXX is the name of your model), and then select **Printer properties**. If printer driver options appear, select your printer driver.  
The printer properties dialog box appears.
3. Click the **Device Settings** tab.
4. Click the **Auto Detect** button.  
The Optional Tray and the machine's serial number are automatically detected.
5. Click the **Apply** button.
6. Close the printer properties dialog box.

The **Auto Detect** function is not available under the following machine conditions:

- The machine power switch is off.
- The machine is in a network-shared environment.
- The machine and your computer are not connected.



### Related Information

- [Change the Default Print Settings \(Windows\)](#)

## Print a Document Using the BR-Script3 Printer Driver (PostScript® 3™ Language Emulation) (Windows)

The BR-Script3 printer driver lets you print PostScript® data more clearly.

Go to your model's **Downloads** page at [support.brother.com](http://support.brother.com) to install the PS driver (BR-Script3 printer driver).

1. Select the print command in your application.
2. Select **Brother XXX-XXXX BR-Script3** (where XXXX is the name of your model), and then click the printing properties or preferences button.

The printer driver window appears.

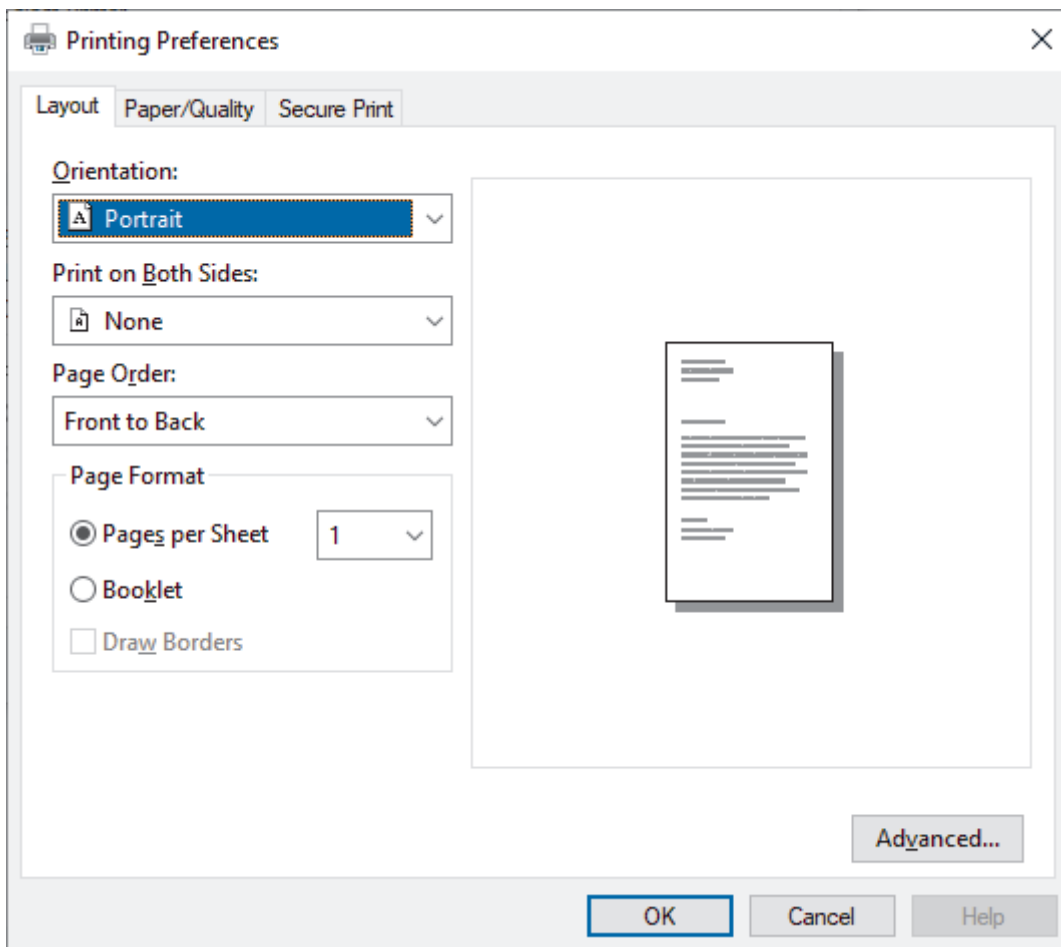

3. Click the **Layout**, **Paper/Quality**, or **Secure Print** tab to change basic print settings. (available only for certain models)  
Click the **Layout** or **Paper/Quality** tab, and then click the **Advanced...** button to change advanced print settings. Click **OK**.
4. Click **OK**.
5. Complete your print operation.

### ✓ Related Information

- [Print from Your Computer \(Windows\)](#)

## Monitor the Status of the Machine from Your Computer (Windows)

The Status Monitor is a configurable software tool for monitoring the status of one or more machines, allowing you to get immediate notification of errors.

Do one of the following:



- Double-click the  icon in the task tray.

- (Windows 10)

Click  > **Brother** > **Brother Utilities**.

Click the drop-down list and select your model name (if not already selected). Click **Tools** in the left navigation bar, and then click **Status Monitor**.

- (Windows 8.1)

Move your mouse to the lower left corner of the **Start** screen and click  (if you are using a touch-based device, swipe up from bottom of the **Start** screen to bring up the **Apps** screen). When the **Apps** screen appears, tap or click  (**Brother Utilities**), and then click the drop-down list and select your model name (if not already selected). Click **Tools** in the left navigation bar, and then click **Status Monitor**.

- (Windows 8.1)

Click  (**Brother Utilities**), and then click the drop-down list and select your model name (if not already selected). Click **Tools** in the left navigation bar, and then click **Status Monitor**.

- (Windows 7)

Click  (**Start**) > **All Programs** > **Brother** > **Brother Utilities**.

Click the drop-down list and select your model name (if not already selected). Click **Tools** in the left navigation bar, and then click **Status Monitor**.

### Troubleshooting

Click the **Troubleshooting** button to access the support website.

### Looking for replacement supplies?

Click the **Looking for replacement supplies?** button for more information on Brother genuine supplies.



### Related Information

- [Print from Your Computer \(Windows\)](#)

#### Related Topics:

- [Printing Problems](#)

## **Print from Your Computer (Mac)**

- [Print Using AirPrint](#)

## Print Using AirPrint

- [Print from iPad, iPhone, or iPod touch](#)
- [Print Using AirPrint \(macOS\)](#)



## Secure Print Using a USB Flash Drive

USB Storage Print allows you to save secure print data to a USB flash drive and print it later by entering a password on the machine's control panel.

### NOTE



USB flash drive requirements:

- Storage Size: 8 GB or more (Recommended: 8 GB to 16 GB)
- Format: FAT32/exFAT

For more information on the printer driver settings, see *Related Information*.

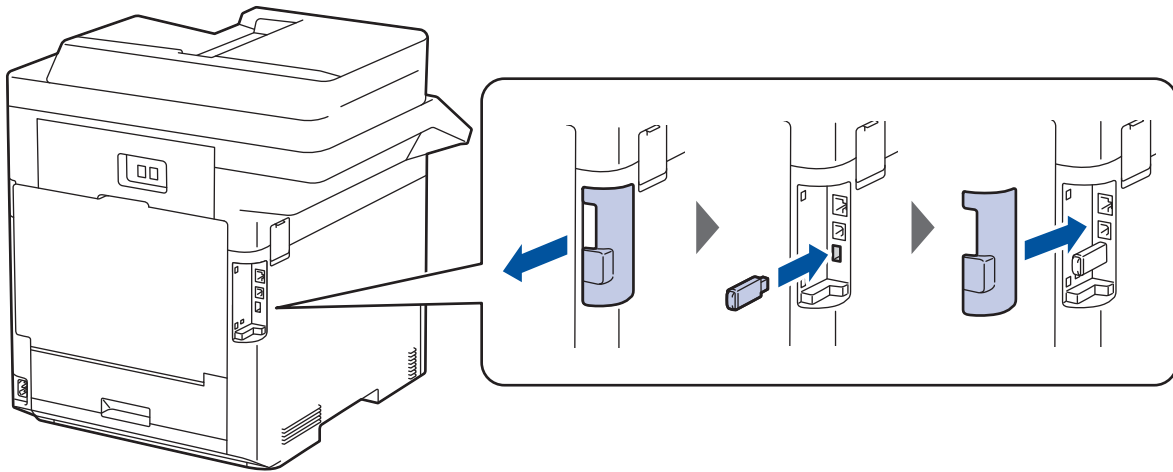
1. Connect your USB flash drive to the USB port (Rear).



2. Press .
3. On the machine's control panel, press  [Settings] > [All Settings] > [Printer] > [Job Save Location].



If your machine displays the [All Settings] menu on the Home screen, skip the [Settings] menu.

4. Press [USB flash drive (Rear port)].  
Follow the prompt on the LCD to initialise the USB flash drive.

### NOTE

When you change the job save location, all the stored job, font, macro, and stream data in the machine's memory will be deleted.

5. Press and hold [OK] for two seconds to initialise.  
The machine will restart to activate the USB Storage Print feature.

### NOTE

When the machine restarts to activate the USB Storage Print feature, the Macro, Stream, and Font data will be deleted from the USB flash drive.

6. In the printer driver properties, configure the Secure Print settings, and then select the print command in your application.

- 
7. On the machine's control panel, swipe left or right or press ◀ or ▶ to display the [Secure Print] option, and then press [Secure Print].
  8. Swipe up or down or press ▲ or ▼ to display user names, and then press your user name.
  9. Enter your four-digit password, and then press [OK].
  10. Swipe up or down or press ▲ or ▼ to display the print job, and then press it.
  11. Enter the number of copies you want, and then press [OK].
  12. Press [Start].

The machine prints the data and deletes the print job from the USB flash drive.

## IMPORTANT

DO NOT remove the USB flash drive from the USB port (Rear) until the machine has finished printing.

---



### Related Information

- [Print](#)

#### Related Topics:

- [Error and Maintenance Messages](#)
  - [The Input/Output Ports on Your Machine](#)
-

## Print Data Directly from a USB Flash Drive

You can print photos directly from a digital camera or a USB flash drive. Supported file types are PDF, JPEG, TIFF, XPS, and PRN.

- [Compatible USB Flash Drives](#)
- [Print Data Directly from a USB Flash Drive or Digital Camera Supporting Mass Storage](#)
- [Create a PRN File for Direct Printing \(Windows\)](#)

## Compatible USB Flash Drives

### IMPORTANT

The USB direct interface supports only USB flash drives and digital cameras that use the USB mass storage standard. Other USB devices are not supported.

| Compatible USB Flash Drives |                                      |
|-----------------------------|--------------------------------------|
| USB Class                   | USB Mass Storage Class               |
| USB Mass Storage Sub Class  | SCSI or SFF-8070i                    |
| Transfer Protocol           | Bulk transfer Only                   |
| Format <sup>1</sup>         | FAT12/FAT16/FAT32/exFAT              |
| Sector Size                 | Max. 4096 Byte                       |
| Encryption                  | Encrypted devices are not supported. |

<sup>1</sup> NTFS format is not supported.



### Related Information

- [Print Data Directly from a USB Flash Drive](#)

## Print Data Directly from a USB Flash Drive or Digital Camera Supporting Mass Storage

- Make sure your digital camera is turned on.
- Your digital camera must be switched from PictBridge mode to Mass Storage mode.

### IMPORTANT

To prevent damage to your machine, DO NOT connect any device other than a digital camera or USB flash drive to the USB direct interface.

#### USB Port Location (Front View)

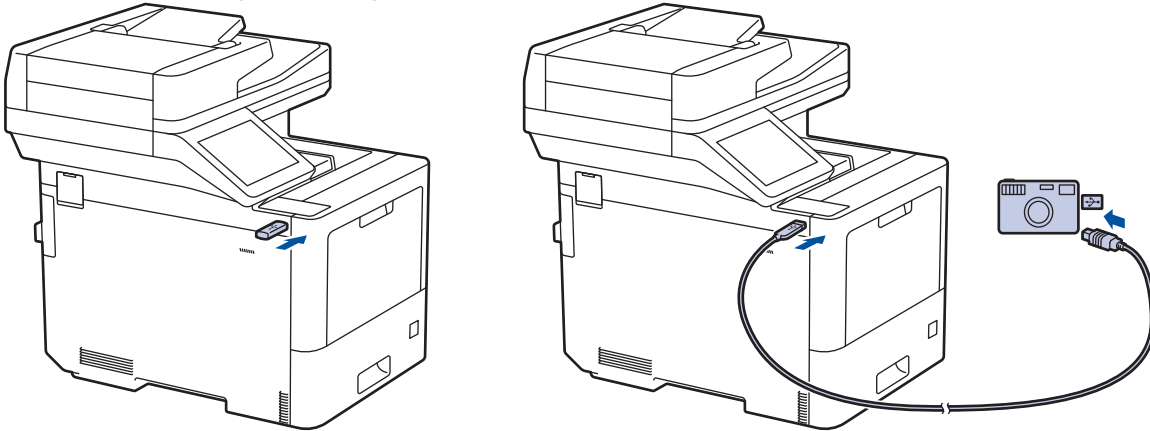

#### USB Port Location (Rear View)

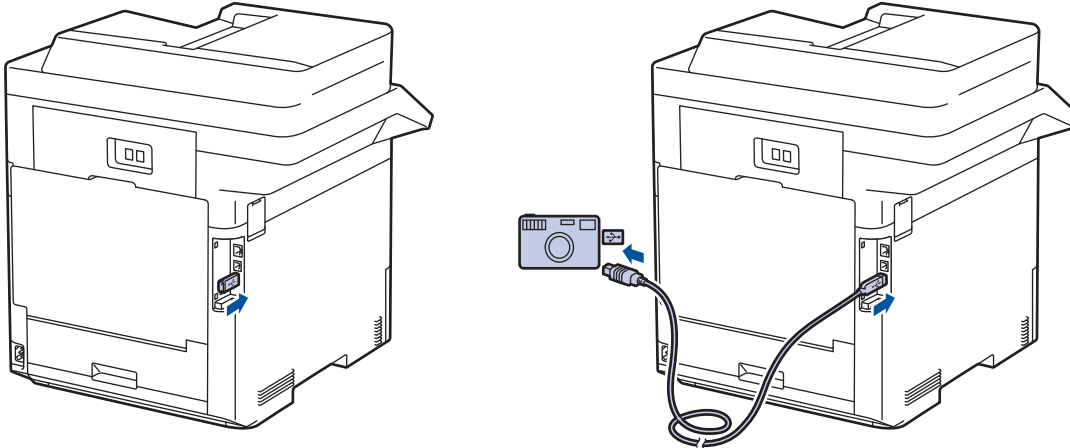

1. Connect your USB flash drive or digital camera to the USB direct interface. The touchscreen will automatically display the USB menu to confirm that the USB flash drive or digital camera is correctly connected.



- If an error occurs, the USB menu will not appear on the touchscreen.
- When the machine is in Deep Sleep mode, the touchscreen does not display any information even if you connect a USB flash drive to the USB direct interface. Press the touchscreen to wake up the machine.
- If your machine's Secure Function Lock is On, you may not be able to print from a USB flash drive or digital camera.
- (MFC-L9630CDN/MFC-L9635CDN/MFC-L9670CDN/MFC-EX670) If the machine prompts you to choose the USB port, select it on the touchscreen.

2. Press [Direct Print].

---

3. Swipe up or down, or press ▲ or ▼ to display the file you want to print, and then select the file.



---

To print an index of the files stored on the USB flash drive or digital camera, press [Index Print] on the touchscreen. Press [Mono Start] or [Colour Start] to print the data.

---

4. Do one of the following:

- To change the settings, press [Print Settings]. Go to the next step.
- If you want to use the default settings, enter the number of copies, and then press [Mono Start] or [Colour Start].

5. Select the print settings you want to change:

- [Print Quality]
- [Tray Use]
- [Paper Type]
- [Paper Size]
- [Multiple Page]
- [Orientation]
- [2-sided]
- [Collate]
- [PDF Print Options]
- [PDF Fit to Page]



---

Depending on the file type, some of these settings may not appear.

---

6. Press [OK].

7. Enter the number of copies you want.

8. Press [Mono Start] or [Colour Start] to print the data.

9. Press .

## IMPORTANT

DO NOT remove the USB flash drive or digital camera from the USB direct interface until the machine has finished printing.

---



## Related Information

- [Print Data Directly from a USB Flash Drive](#)
-

## Create a PRN File for Direct Printing (Windows)

These instructions may vary depending on your print application and operating system.

1. Select the print command in your application.
2. Select your model, and then select the print to file option.
3. Complete your print operation.
4. Enter the required information to save the file.



---

If the computer prompts you to enter a file name only, you can also specify the folder where you want to save the file by typing the directory name (for example: C:\Temp\FileName.prn).

If a USB flash drive is connected to your computer, you can save the file directly to the USB flash drive.

---



### Related Information

- [Print Data Directly from a USB Flash Drive](#)
-

## Print Duplicate Copies

Use the Carbon Copy function to make multiple copies of the same print data, as if printing on carbon paper. Send the data to individual paper trays that you loaded with different paper types or colours.

For example, you may want to set the machine to send your print data to Tray 1, in which you have loaded blue coloured paper, and then reprint the data in a certain location on the page from the MP Tray, in which you have loaded yellow coloured paper that already contains text.

If you load blue paper in Tray 1 and yellow paper in the MP tray, the printer will automatically feed paper for Sheet 1 from Tray 1 and Sheet 2 from the MP Tray.

If you enable the Carbon Copy function, the machine will always make copies automatically.



(Windows)

The Carbon Copy function also allows you to select a different printing macro/stream for each page.

1. Press  [Settings] > [All Settings] > [Printer] > [Carbon Menu] > [Carbon Copy] > [On].
2. Swipe up or down or press ▲ or ▼ to display the [Copies] option, and then press the [Copies] option.
3. Enter the number of copies you want, and then press [OK].
4. Swipe up or down or press ▲ or ▼ to display the [Copy1 Tray] option, and then press the [Copy1 Tray] option.
5. Swipe up or down or press ▲ or ▼ to display the paper tray you want to configure the [Copy1 Stream] option, and then press to select the paper tray.



(Windows)

- a. Swipe up or down or press ▲ or ▼ to display the [Copy1 Stream] option, and then press the [Copy1 Stream] option.
- b. Swipe up or down or press ▲ or ▼ to display the ID number of the macro you want to use, and then press it.

6. Repeat these steps until you have selected all the tray settings for each copy.
7. Press .
8. Send your print job to the machine.



### Related Information

- [Print](#)



## Cancel a Print Job

1. Press .



To cancel multiple print jobs, press and hold  for about four seconds.



### Related Information

- [Print](#)

#### Related Topics:

- [Printing Problems](#)
-

## Test Print

If there are problems with print quality, follow these instructions to do a test print:

1. Press  [Settings] > [All Settings] > [Printer] > [Print Options] > [Test Print].



If your machine displays the [All Settings] menu on the Home screen, skip the [Settings] menu.

2. Press [Yes].
3. Press .



### Related Information

- [Print](#)

#### Related Topics:

- [Improve the Print Quality](#)

## Scan

- [Scan Using the Scan Button on Your Machine](#)
- [Scan from Your Computer \(Windows\)](#)
- [Scan from Your Computer \(Mac\)](#)
- [Configure Scan Settings Using Web Based Management](#)

## Scan Using the Scan Button on Your Machine

- [Scan Photos and Graphics](#)
- [Save Scanned Data to a Folder as a PDF File](#)
- [Save Scanned Data to a USB Flash Drive](#)
- [Scan to an Editable Text File \(OCR\)](#)
- [Save Scanned Data as an Email Attachment](#)
- [Send Scanned Data to an Email Recipient](#)
- [Scan to FTP](#)
- [Scan to SSH Server \(SFTP\)](#)
- [Scan to Network \(Windows\)](#)
- [Scan to SharePoint](#)
- [Use the Web Services Protocol for Network Scanning \(Windows 7, Windows 8.1, and Windows 10\)](#)
- [Change the Scan Button Settings from Brother iPrint&Scan](#)
- [Configure Certificates for Signed PDFs](#)
- [Disable Scanning from Your Computer](#)

## Scan Photos and Graphics

Send scanned photos or graphics directly to your computer.

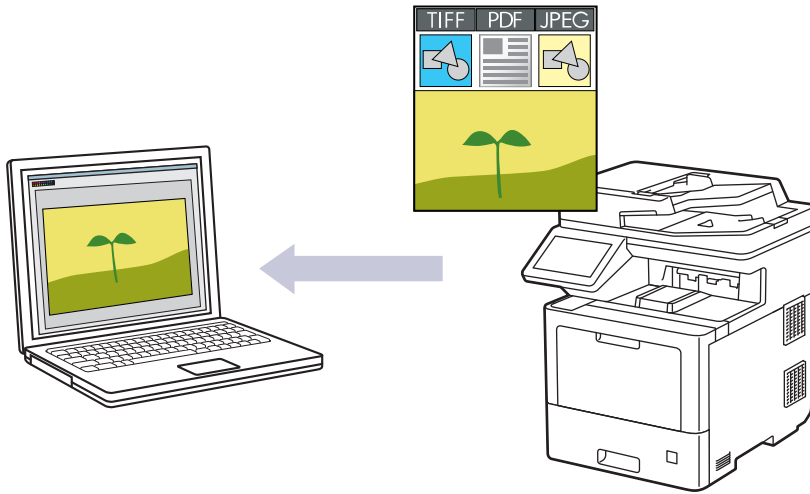

Use the Scan button on the machine to make temporary changes to the scan settings. To make permanent changes, use Brother iPrint&Scan.

1. Load your document.
2. Press [Scan] > [to PC] > [to Image].
3. If the machine is connected over the network, select the computer name where you want to send data.



If the LCD prompts you to enter a PIN for the computer, enter the four-digit PIN on the LCD, and then press [OK].

4. To change the settings, press [Options], and then select the scan settings you want to change. If you use the default settings, skip this step.
  - [2-sided Scan]
  - [Scan Settings]
  - [Colour Setting]
  - [Resolution]
  - [File Type]
  - [Document Size]
  - [Brightness]
  - [Contrast]
  - (available only for the [Colour] and [Grey] options)
  - [Auto Deskew]
  - [Skip Blank Page]
  - [Remove Background Colour]
  - (available only for the [Colour] and [Grey] options)
  - [Moire Reduction]
  - [B&W TIFF Compress]



- To change scan settings, a computer with the Brother iPrint&Scan software installed must be connected to the machine.
- If your machine displays the [OK] button, press [OK].
- To save the settings as a shortcut, press [Save as Shortcut].

---

5. Press [Start].

The machine starts scanning. If using the machine's scanner glass, follow the touchscreen instructions to complete the scanning job.



### **Related Information**

- [Scan Using the Scan Button on Your Machine](#)
-

## Save Scanned Data to a Folder as a PDF File

Scan documents and save them to a folder on your computer as PDF files.

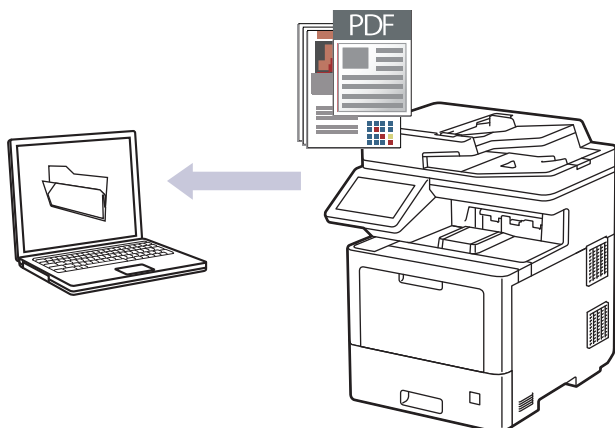

Use the Scan button on the machine to make temporary changes to the scan settings. To make permanent changes, use Brother iPrint&Scan.

1. Load your document.
2. Press [Scan] > [to PC] > [to File].
3. If the machine is connected over the network, select the computer name where you want to send data.



If the LCD prompts you to enter a PIN for the computer, enter the four-digit PIN on the LCD, and then press [OK].

4. To change the settings, press [Options], and then select the scan settings you want to change. If you use the default settings, skip this step.
  - [2-sided Scan]
  - [Scan Settings]
  - [Colour Setting]
  - [Resolution]
  - [File Type]
  - [Document Size]
  - [Brightness]
  - [Contrast]
  - (available only for the [Colour] and [Grey] options)
  - [Auto Deskew]
  - [Skip Blank Page]
  - [Remove Background Colour]
  - (available only for the [Colour] and [Grey] options)
  - [Moire Reduction]
  - [B&W TIFF Compress]



- To change scan settings, a computer with the Brother iPrint&Scan software installed must be connected to the machine.
- If your machine displays the [OK] button, press [OK].
- To save the settings as a shortcut, press [Save as Shortcut].

---

5. Press [Start].

The machine starts scanning. If using the machine's scanner glass, follow the touchscreen instructions to complete the scanning job.



### **Related Information**

- [Scan Using the Scan Button on Your Machine](#)
-



## Save Scanned Data to a USB Flash Drive

Scan documents directly to a USB flash drive.

1. Load your document.
2. Insert a USB flash drive into your machine.
3. Press [Scan to USB].
4. To change the settings, press [Options], and then select the scan settings you want to change. If you use the default settings, skip this step.
  - [2-sided Scan]
  - [Colour Setting]
  - [Resolution]
  - [File Type]
  - [Document Size]
  - [Brightness]
  - [Contrast]  
(available only for the [Colour] and [Grey] options)
  - [File Name]
  - [File Name Style]
  - [File Size]  
(available only for the [Colour] and [Grey] options)
  - [Auto Deskew]
  - [Skip Blank Page]
  - [Skip Blank Page Sensitivity]
  - [Remove Background Colour]  
(available only for the [Colour] and [Grey] options)
  - [Margin Settings]
  - [Moire Reduction]
  - [Document Separation]
  - [B&W TIFF Compress]



- If your machine displays the [OK] button, press [OK].
- To set your own default settings: after making changes to settings, press the [Set New Default] option, and then press [Yes].
- To restore the factory settings: press [Factory Reset], and then press [Yes].
- To save the settings as a shortcut, press [Save as Shortcut].

5. Press [Start].



(MFC-L9630CDN/MFC-L9635CDN/MFC-L9670CDN/MFC-EX670)

If the machine prompts you to select the USB host, make your selection.

The machine starts scanning. If using the machine's scanner glass, follow the touchscreen instructions to complete the scanning job.

---

## IMPORTANT

The LCD displays a message while reading the data. DO NOT unplug the power cord or remove the USB flash drive from the machine while it is reading the data. You could lose your data or damage the USB flash drive.

---



### Related Information

---

- [Scan Using the Scan Button on Your Machine](#)
-

## Scan to an Editable Text File (OCR)

Your machine can convert characters in a scanned document to text using the optical character recognition (OCR) technology. You can edit this text using your preferred text-editing application.

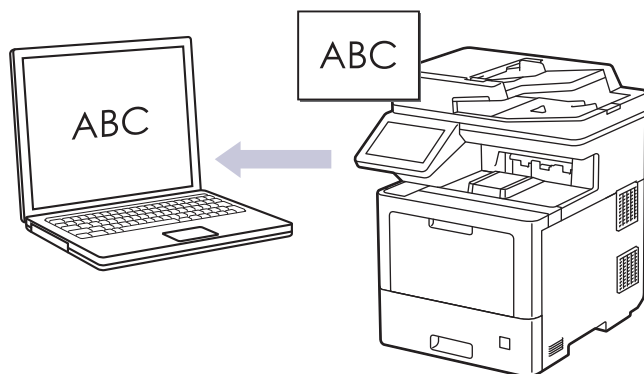

- The Scan to OCR feature is available only for certain languages.
- Use the Scan button on the machine to make temporary changes to the scan settings. To make permanent changes, use Brother iPrint&Scan.

1. Load your document.
2. Press [Scan] > [to PC] > [to OCR].
3. If the machine is connected over the network, select the computer name where you want to send data.



If the LCD prompts you to enter a PIN for the computer, enter the four-digit PIN on the LCD, and then press [OK].

4. To change the settings, press [Options], and then select the scan settings you want to change. If you use the default settings, skip this step.
  - [2-sided Scan]
  - [Scan Settings]
  - [Colour Setting]
  - [Resolution]
  - [File Type]
  - [Document Size]
  - [Brightness]
  - [Contrast]
  - (available only for the [Colour] and [Grey] options)
  - [Auto Deskew]
  - [Skip Blank Page]
  - [Remove Background Colour]
  - (available only for the [Colour] and [Grey] options)
  - [Moire Reduction]



- To change scan settings, a computer with the Brother iPrint&Scan software installed must be connected to the machine.
- If your machine displays the [OK] button, press [OK].
- To save the settings as a shortcut, press [Save as Shortcut].

5. Press [Start].

---

The machine starts scanning. If using the machine's scanner glass, follow the touchscreen instructions to complete the scanning job.



### **Related Information**

- [Scan Using the Scan Button on Your Machine](#)
-

## Save Scanned Data as an Email Attachment

Send the scanned data from your machine to your email application as an attachment.

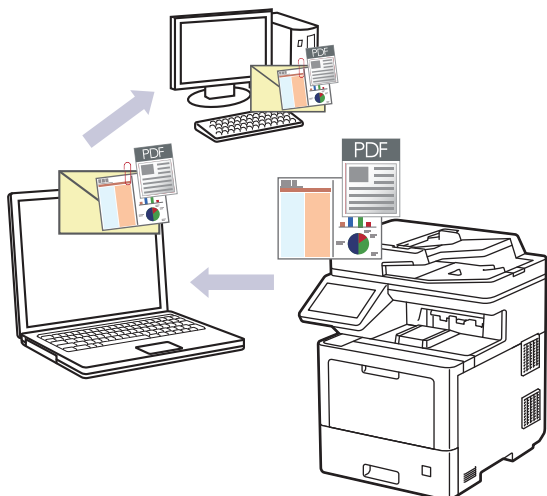

- Use the Scan button on the machine to make temporary changes to the scan settings. To make permanent changes, use Brother iPrint&Scan.
- To scan to email using the machine's Scan Button, make sure you select one of these applications in Brother iPrint&Scan:
  - Windows: Microsoft Outlook
  - Mac: Apple MailFor other applications and Webmail services, use the Scan to Image or Scan to File feature to scan a document, and then attach the scanned file to an email message.

1. Load your document.
2. Press [Scan] > [to PC] > [to E-mail].
3. If the machine is connected over the network, select the computer name where you want to send data.



If the LCD prompts you to enter a PIN for the computer, enter the four-digit PIN on the LCD, and then press [OK].

4. To change the settings, press [Options], and then select the scan settings you want to change. If you use the default settings, skip this step.
  - [2-sided Scan]
  - [Scan Settings]
  - [Colour Setting]
  - [Resolution]
  - [File Type]
  - [Document Size]
  - [Brightness]
  - [Contrast]  
(available only for the [Colour] and [Grey] options)
  - [Auto Deskew]
  - [Skip Blank Page]
  - [Remove Background Colour]  
(available only for the [Colour] and [Grey] options)

- 
- [Moire Reduction]
  - [B&W TIFF Compress]



- 
- To change scan settings, a computer with the Brother iPrint&Scan software installed must be connected to the machine.
  - If your machine displays the [OK] button, press [OK].
  - To save the settings as a shortcut, press [Save as Shortcut].
- 

5. Press [Start].

The machine starts scanning. If using the machine's scanner glass, follow the touchscreen instructions to complete the scanning job.



### Related Information

- [Scan Using the Scan Button on Your Machine](#)
-

## Send Scanned Data to an Email Recipient

Send scanned data directly from your machine to an email recipient without using a computer. To send the scanned data as an attachment directly to your default email application using the iPrint&Scan software on your computer, or the Scan button on your machine, use the "Scan to Email Attachment" function instead.

- To send scanned data to an email recipient, you must configure your machine to communicate with your network and email server, which is used to send and receive emails.
- You can configure these items from the machine's control panel or Web Based Management.
- To use the Scan to Email Server function, your machine will need to be connected to a network and have access to an SMTP server. You will need the following SMTP email settings before you can proceed:
  - Server address
  - Port number
  - User name
  - Encryption type (SSL or TLS)
  - Email server certificate (if used)

If you do not know these settings, contact your email service provider or network administrator.

1. Load your document.
2. Press [Scan] > [to E-mail Server].



- If you registered your email address with your user ID, the [to My E-mail] option appears when you log on to the machine using Secure Function Lock, Active Directory Authentication, or LDAP Authentication.
- To send scanned data to your email address, press [to My E-mail]. When your email address appears on the LCD, press [Next].
- To enable this feature in Web Based Management, click the **Scan** tab, and then click the **Scan to E-mail Server** menu in the left navigation bar. In the **Send to My E-mail** field, select **On**. Click **Submit**.

3. Do one of the following to enter the destination email address:
  - To enter the email address manually, press [Manual], and then enter the email address using the keyboard on the LCD. When finished, press [OK].
  - If the email address is stored in the machine's address book, press [Address Book], and then select the email address.  
Press [OK].
4. Confirm the email address, and then press [Next].
5. To change the settings, press [Options], and then select the scan settings you want to change. If you use the default settings, skip this step.
  - [2-sided Scan]
  - [Colour Setting]
  - [Resolution]
  - [File Type]
  - [Document Size]
  - [Brightness]
  - [Contrast]  
(available only for the [Colour] and [Grey] options)
  - [File Name]
  - [File Name Style]
  - [File Size]

---

(available only for the [Colour] and [Grey] options)

- [Auto Deskew]
- [Skip Blank Page]
- [Skip Blank Page Sensitivity]
- [Remove Background Colour]

(available only for the [Colour] and [Grey] options)

- [Margin Settings]
- [Moire Reduction]
- [Document Separation]
- [B&W TIFF Compress]



- 
- To change scan settings, a computer with the Brother iPrint&Scan software installed must be connected to the machine.
  - If your machine displays the [OK] button, press [OK].
  - To set your own default settings: after making changes to settings, press the [Set New Default] option, and then press [Yes].
  - To restore the factory settings: press [Factory Reset], and then press [Yes].
  - To save the settings as a shortcut, press [Save as Shortcut].

(This function may not be available depending on your machine conditions.)

---

6. Press [Start].

The machine starts scanning. If using the machine's scanner glass, follow the touchscreen instructions to complete the scanning job.



### Related Information

- [Scan Using the Scan Button on Your Machine](#)
-



## Scan to FTP

Scan documents directly to an FTP server when you need to share the scanned information. For added convenience, configure different profiles to save your favourite Scan to FTP destinations.

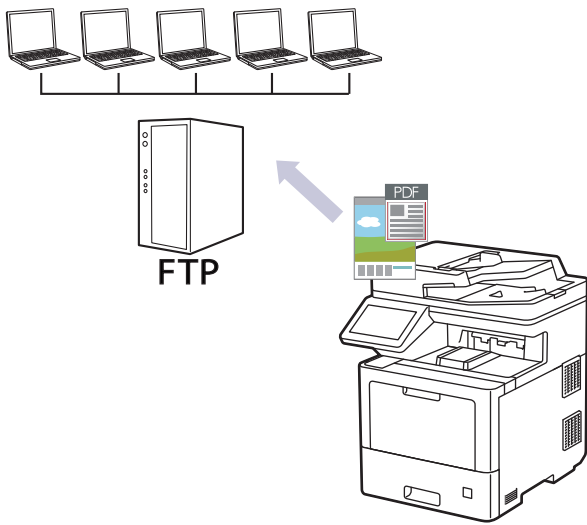

- [Set up a Scan to FTP Profile](#)
- [Upload Scanned Data to an FTP Server](#)

## Set up a Scan to FTP Profile

Set up a Scan to FTP Profile to scan and upload the scanned data directly to an FTP location.

We recommend Microsoft Internet Explorer 11/Microsoft Edge for Windows, Safari 12/13 for Mac, Google Chrome™ for Android (4.x or later), and Google Chrome™/Safari for iOS (10.x or later). Make sure that JavaScript and Cookies are always enabled in whichever browser you use.

1. Start your web browser.
2. Type "https://machine's IP address" in your browser's address bar (where "machine's IP address" is the machine's IP address).

For example:

https://192.168.1.2

3. If required, type the password in the **Login** field, and then click **Login**.



The default password to manage this machine's settings is located on the back of the machine and marked "Pwd".

4. Click the **Scan** tab.
5. Click the **Scan to FTP / SFTP / Network / SharePoint** menu in the navigation bar.
6. Select the **FTP** option, and then click **Submit**.
7. Click the **Scan to FTP / SFTP / Network / SharePoint Profile** menu in the navigation bar.
8. Select the profile you want to set up or change.



Using the following characters: ?, /, \, ", :, <, >, | or \* may cause a sending error.

| Option                 | Description  |
|------------------------|--|
| <b>Profile Name</b>    | Type a name for this server profile (up to 15 alphanumeric characters). The machine will display this name on the LCD.   |
| <b>Host Address</b>    | Type the Host Address (for example: ftp.example.com; up to 64 characters) or the IP address (for example: 192.23.56.189).  |
| <b>Port Number</b>     | Change the <b>Port Number</b> setting used to access the FTP server. The default setting is port 21. In most cases this setting does not need to be changed.   |
| <b>Username</b>        | Type a user name (up to 32 characters) that has permission to write data to the FTP server.  |
| <b>Password</b>        | Type the password (up to 32 characters) associated with the user name you entered in the <b>Username</b> field. Type the password again in the <b>Retype password</b> field.   |
| <b>SSL/TLS</b>         | Set the <b>SSL/TLS</b> option to scan securely using SSL/TLS communication. Change the <b>CA Certificate</b> setting, if needed.   |
| <b>Store Directory</b> | Type the path to the folder on the FTP server where you want to send your scanned data. Do not type a slash mark at the beginning of the path (see example).<br><br><b>Store Directory</b><br><input type="text" value="brother/abc"/>   |
| <b>File Name</b>       | Select a file name prefix from the preset names provided, or from user-defined names. The file name used for the scanned document will be the file name prefix you select, followed by the last six digits of the flatbed/ADF scanner counter and the file extension (for example: "Estimate_098765.pdf"). |

| Option                             | Description  |
|------------------------------------|--|
| <b>Quality</b>                     | Select a quality setting. If you choose the <b>User Select</b> option, the machine will prompt users to select a setting each time they use the scan profile.  |
| <b>File Type</b>                   | Select the file type you want to use for the scanned document. If you choose the <b>User Select</b> option, the machine will prompt users to select a setting each time they use the scan profile.   |
| <b>Document Size</b>               | Select your document size from the list. This is necessary to make sure the scanned file is the correct size.<br>If you choose the <b>User Select</b> option, the machine will prompt users to select a setting each time they use the scan profile. |
| <b>File Size</b>                   | Select your file size from the list.<br>If you choose the <b>User Select</b> option, the machine will prompt users to select a setting each time they use the scan profile.  |
| <b>Auto Deskew</b>                 | Select <b>Auto</b> to set the machine to correct document skewing automatically as the pages are scanned.  |
| <b>Skip Blank Page</b>             | Select the <b>On</b> option to remove blank pages of the document from the scanning results.   |
| <b>Skip Blank Page Sensitivity</b> | Select the sensitivity level for detecting blank pages in the scanned data. The higher the sensitivity, the easier it is for the machine to detect blank pages.  |
| <b>2-sided Scan</b>                | Select <b>Long Edge</b> or <b>Short Edge</b> to scan both sides of the document, depending on the layout of your original.   |
| <b>Remove Background Colour</b>    | Change the amount of background colour that is removed.  |
| <b>Margin Settings</b>             | Adjust your document's margins.  |
| <b>Moire Reduction</b>             | Select <b>On</b> to reduce the moire pattern, or cross-hatching, in a scanned image.   |
| <b>Document Separation</b>         | Split a scanned image.<br>When multiple documents have been scanned, you can split and save the documents separately by using this function.   |
| <b>B&amp;W TIFF Compress</b>       | Select the TIFF compression option for a black and white document.   |
| <b>Brightness</b>                  | Select the brightness level.   |
| <b>Contrast</b>                    | Select the contrast level.   |
| <b>Passive Mode</b>                | Set the <b>Passive Mode</b> option to off or on depending on your FTP server and network firewall configuration. The default setting is on. In most cases, this setting does not need to be changed.   |

9. Click **Submit**.



## Related Information

- [Scan to FTP](#)

## Upload Scanned Data to an FTP Server

Share scanned information by saving it to your FTP server.

1. Load your document.
2. Press [Scan] > [to FTP/SFTP].
3. When the server profiles you set up using Web Based Management appear, select the profile you want. If the profile is not complete (for example, if the logon account name and password are missing, or if the quality or file type is not specified), you will be prompted to enter any missing information.
4. Press [Start].

The machine starts scanning. If using the machine's scanner glass, follow the touchscreen instructions to complete the scanning job.



### Related Information

- [Scan to FTP](#)

## Scan to SSH Server (SFTP)

Uses the Secure Shell Protocol to establish a private and safe data stream when scanning documents to a network destination. For added convenience, configure different profiles to save your favourite Scan to SFTP destinations.

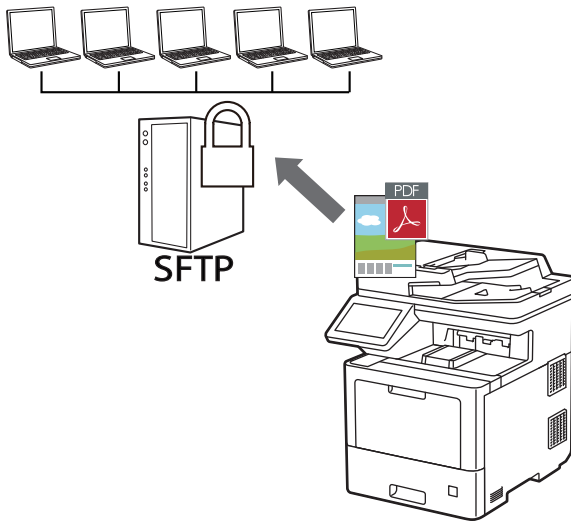

- [Set up a Scan to SFTP Profile](#)
- [Create a Client Key Pair Using Web Based Management](#)
- [Export a Client Key Pair Using Web Based Management](#)
- [Import a Server Public Key Using Web Based Management](#)
- [Upload Scanned Data to an SFTP Server](#)

## Set up a Scan to SFTP Profile

Set up a Scan to SFTP Profile to scan and upload scanned data directly to an SFTP location.

We recommend Microsoft Internet Explorer 11/Microsoft Edge for Windows, Safari 12/13 for Mac, Google Chrome™ for Android (4.x or later), and Google Chrome™/Safari for iOS (10.x or later). Make sure that JavaScript and Cookies are always enabled in whichever browser you use.

1. Start your web browser.
2. Type "https://machine's IP address" in your browser's address bar (where "machine's IP address" is the machine's IP address).

For example:

https://192.168.1.2

3. If required, type the password in the **Login** field, and then click **Login**.



The default password to manage this machine's settings is located on the back of the machine and marked "Pwd".

4. Click the **Scan** tab.
5. Click the **Scan to FTP / SFTP / Network / SharePoint** menu in the navigation bar.
6. Select the **SFTP** option, and then click **Submit**.
7. Click the **Scan to FTP / SFTP / Network / SharePoint Profile** menu in the navigation bar.
8. Select the profile you want to set up or change.



Using the following characters: ?, /, \, ", :, <, >, | or \* may cause a sending error.

| Option                   | Description  |
|--------------------------|--|
| <b>Profile Name</b>      | Type a name for this server profile (up to 15 alphanumeric characters). The machine will display this name on the LCD.   |
| <b>Host Address</b>      | Type the Host Address (for example: ftp.example.com; up to 64 characters) or the IP address (for example: 192.23.56.189).  |
| <b>Username</b>          | Type a user name (up to 32 characters) that has permission to write data to the SFTP server.   |
| <b>Auth. Method</b>      | Select <b>Password</b> or <b>Public Key</b> .  |
| <b>Password</b>          | When you select <b>Password</b> for the <b>Auth. Method</b> option, type the password (up to 32 characters) associated with the user name you typed in the <b>Username</b> field. Type the password again in the <b>Retype password</b> field. |
| <b>Client Key Pair</b>   | When you select <b>Public Key</b> for the <b>Auth. Method</b> option, select the authentication type.  |
| <b>Server Public Key</b> | Select the authentication type.  |
| <b>Store Directory</b>   | Type the path to the folder on the SFTP server where you want to send your scanned data. Do not type a slash mark at the beginning of the path (see example).<br><br><b>Store Directory</b><br><input type="text" value="brother/abc"/>        |
| <b>File Name</b>         | Select a file name prefix from the preset names provided, or from user-defined names. The file name used for the scanned document will be the file name prefix you select, followed by the last six digits of the                              |

| Option                             | Description  |
|------------------------------------|--|
|                                    | flatbed/ADF scanner counter and the file extension (for example: "Estimate_098765.pdf").   |
| <b>Quality</b>                     | Select a quality setting. If you choose the <b>User Select</b> option, the machine will prompt users to select a setting each time they use the scan profile.  |
| <b>File Type</b>                   | Select the file type you want to use for the scanned document. If you choose the <b>User Select</b> option, the machine will prompt users to select a setting each time they use the scan profile.   |
| <b>Document Size</b>               | Select your document size from the list. This is necessary to make sure the scanned file is the correct size.<br><br>If you choose the <b>User Select</b> option, the machine will prompt users to select a setting each time they use the scan profile. |
| <b>File Size</b>                   | Select your file size from the list.<br><br>If you choose the <b>User Select</b> option, the machine will prompt users to select a setting each time they use the scan profile.  |
| <b>Auto Deskew</b>                 | Select <b>Auto</b> to set the machine to correct document skewing automatically as the pages are scanned.  |
| <b>Skip Blank Page</b>             | Select the <b>On</b> option to remove blank pages of the document from the scanning results.   |
| <b>Skip Blank Page Sensitivity</b> | Select the sensitivity level for detecting blank pages in the scanned data. The higher the sensitivity, the easier it is for the machine to detect blank pages.  |
| <b>2-sided Scan</b>                | Select <b>Long Edge</b> or <b>Short Edge</b> to scan both sides of the document, depending on the layout of your original.   |
| <b>Remove Background Colour</b>    | Change the amount of background colour that is removed.  |
| <b>Margin Settings</b>             | Adjust your document's margins.  |
| <b>Moire Reduction</b>             | Select <b>On</b> to reduce the moire pattern, or cross-hatching, in a scanned image.   |
| <b>Document Separation</b>         | Split a scanned image.<br><br>When multiple documents have been scanned, you can split and save the documents separately by using this function.   |
| <b>B&amp;W TIFF Compress</b>       | Select the TIFF compression option for a black and white document.   |
| <b>Brightness</b>                  | Select the brightness level.   |
| <b>Contrast</b>                    | Select the contrast level.   |
| <b>Port Number</b>                 | Change the <b>Port Number</b> setting used to access the SFTP server. The default setting is port 22. In most cases, this setting does not need to be changed.   |

9. Click **Submit**.



## Related Information

- [Scan to SSH Server \(SFTP\)](#)

## Create a Client Key Pair Using Web Based Management

1. Start your web browser.
2. Type "https://machine's IP address" in your browser's address bar (where "machine's IP address" is the machine's IP address).

For example:

https://192.168.1.2



If you are using a Domain Name System or enable a NetBIOS name, you can type another name, such as "SharedPrinter" instead of the IP address.

For example:

https://SharedPrinter

If you enable a NetBIOS name, you can also use the node name.

For example:

https://brnxxxxxxxxxxxx

The NetBIOS name can be found in the Network Configuration Report.

3. If required, type the password in the **Login** field, and then click **Login**.



The default password to manage this machine's settings is located on the back of the machine and marked "Pwd".

4. Go to the navigation menu, and then click **Network > Security > Client Key Pair**.



Start from , if the navigation menu is not shown on the left side of the screen.

5. Click **Create New Client Key Pair**.
6. In the **Client Key Pair Name** field, type the name (up to 20 characters) you want.
7. Click the **Public Key Algorithm** drop-down list, and then select the algorithm you want.
8. Click **Submit**.

The client key pair is created and saved in your machine's memory. The client key pair name and public key algorithm will be displayed in the **Client Key Pair List**.



### Related Information

- [Scan to SSH Server \(SFTP\)](#)



## Export a Client Key Pair Using Web Based Management

1. Start your web browser.
2. Type "https://machine's IP address" in your browser's address bar (where "machine's IP address" is the machine's IP address).

For example:

https://192.168.1.2



If you are using a Domain Name System or enable a NetBIOS name, you can type another name, such as "SharedPrinter" instead of the IP address.

For example:

https://SharedPrinter

If you enable a NetBIOS name, you can also use the node name.

For example:

https://brnxxxxxxxxxxxx

The NetBIOS name can be found in the Network Configuration Report.

3. If required, type the password in the **Login** field, and then click **Login**.



The default password to manage this machine's settings is located on the back of the machine and marked "Pwd".

4. Go to the navigation menu, and then click **Network > Security > Client Key Pair**.



Start from , if the navigation menu is not shown on the left side of the screen.

5. Click **Export Public Key** shown with **Client Key Pair List**.
6. Click **Submit**.
7. Specify the location where you want to save the file.

The client key pair is exported to your computer.



### Related Information

- [Scan to SSH Server \(SFTP\)](#)

## Import a Server Public Key Using Web Based Management

1. Start your web browser.
2. Type "https://machine's IP address" in your browser's address bar (where "machine's IP address" is the machine's IP address).

For example:

https://192.168.1.2



If you are using a Domain Name System or enable a NetBIOS name, you can type another name, such as "SharedPrinter" instead of the IP address.

For example:

https://SharedPrinter

If you enable a NetBIOS name, you can also use the node name.

For example:

https://brnxxxxxxxxxxxx

The NetBIOS name can be found in the Network Configuration Report.

3. If required, type the password in the **Login** field, and then click **Login**.



The default password to manage this machine's settings is located on the back of the machine and marked "Pwd".

4. Go to the navigation menu, and then click **Network > Security > Server Public Key**.



Start from , if the navigation menu is not shown on the left side of the screen.

5. Click **Import Server Public Key**.
6. Specify the file that you want to import.
7. Click **Submit**.

The server public key is imported to your machine.



### Related Information

- [Scan to SSH Server \(SFTP\)](#)

## Upload Scanned Data to an SFTP Server

1. Load your document.
2. Press [Scan] > [to FTP/SFTP].
3. When the server profiles you set up using Web Based Management appear, select the profile you want. If the profile is not complete (for example, if the logon account name and password are missing, or if the quality or file type is not specified), you will be prompted to enter any missing information.
4. Press [Start].

The machine starts scanning. If using the machine's scanner glass, follow the touchscreen instructions to complete the scanning job.



### Related Information

- [Scan to SSH Server \(SFTP\)](#)

## Scan to Network (Windows)

Scan documents directly to a CIFS server on your local network. For added convenience, you can configure different profiles to save your favourite Scan to Network destinations.

- [Set up a Scan to Network Profile](#)
- [Upload Scanned Data to a CIFS Server](#)

## Set up a Scan to Network Profile

Set up a Scan to Network Profile to scan and upload scanned data directly to a folder on a CIFS server.

We recommend Microsoft Internet Explorer 11/Microsoft Edge for Windows, Safari 12/13 for Mac, Google Chrome™ for Android (4.x or later), and Google Chrome™/Safari for iOS (10.x or later). Make sure that JavaScript and Cookies are always enabled in whichever browser you use.

1. Start your web browser.
2. Type "https://machine's IP address" in your browser's address bar (where "machine's IP address" is the machine's IP address).

For example:

https://192.168.1.2

3. If required, type the password in the **Login** field, and then click **Login**.



The default password to manage this machine's settings is located on the back of the machine and marked "Pwd".

4. Click the **Scan** tab.
5. Click the **Scan to FTP / SFTP / Network / SharePoint** menu in the navigation bar.
6. Select the **Network** option, and then click **Submit**.



If you want to send the data to your designated folder on the CIFS server, select **On** for the **Send to My Folder** option.

7. Click the **Scan to FTP / SFTP / Network / SharePoint Profile** menu in the navigation bar.
8. Select the profile you want to set up or change.



Using the following characters: ?, /, \, ", :, <, >, | or \* may cause a sending error.

| Option                     | Description  |
|----------------------------|--|
| <b>Profile Name</b>        | Type a name for this server profile (up to 15 alphanumeric characters). The machine will display this name on the LCD.   |
| <b>Network Folder Path</b> | Type the path to the folder on the CIFS server where you want to send your scanned data.   |
| <b>File Name</b>           | Select a file name prefix from the preset names provided, or from user-defined names. The file name used for the scanned document will be the file name prefix you select, followed by the last six digits of the flatbed/ADF scanner counter and the file extension (for example: "Estimate_098765.pdf"). |
| <b>Quality</b>             | Select a quality setting. If you choose the <b>User Select</b> option, the machine will prompt users to select a setting each time they use the scan profile.  |
| <b>File Type</b>           | Select the file type you want to use for the scanned document. If you choose the <b>User Select</b> option, the machine will prompt users to select a setting each time they use the scan profile.   |
| <b>Document Size</b>       | Select your document size from the list. This is necessary to make sure the scanned file is the correct size.<br>If you choose the <b>User Select</b> option, the machine will prompt users to select a setting each time they use the scan profile.   |
| <b>File Size</b>           | Select your file size from the list.<br>If you choose the <b>User Select</b> option, the machine will prompt users to select a setting each time they use the scan profile.  |

| Option                             | Description  |
|------------------------------------|--|
| <b>Auto Deskew</b>                 | Select <b>Auto</b> to set the machine to correct document skewing automatically as the pages are scanned.  |
| <b>Skip Blank Page</b>             | Select the <b>On</b> option to remove blank pages of the document from the scanning results.   |
| <b>Skip Blank Page Sensitivity</b> | Select the sensitivity level for detecting blank pages in the scanned data. The higher the sensitivity, the easier it is for the machine to detect blank pages.  |
| <b>2-sided Scan</b>                | Select <b>Long Edge</b> or <b>Short Edge</b> to scan both sides of the document, depending on the layout of your original.   |
| <b>Remove Background Colour</b>    | Change the amount of background colour that is removed.  |
| <b>Margin Settings</b>             | Adjust your document's margins.  |
| <b>Moire Reduction</b>             | Select <b>On</b> to reduce the moire pattern, or cross-hatching, in a scanned image.   |
| <b>Document Separation</b>         | Split a scanned image.<br>When multiple documents have been scanned, you can split and save the documents separately by using this function.   |
| <b>B&amp;W TIFF Compress</b>       | Select the TIFF compression option for a black and white document.   |
| <b>Brightness</b>                  | Select the brightness level.   |
| <b>Contrast</b>                    | Select the contrast level.   |
| <b>Use PIN for Authentication</b>  | To PIN-protect this profile, select <b>On</b> and type a four-digit PIN in the <b>PIN Code</b> field.  |
| <b>Auth. Method</b>                | To set your authentication method, select <b>Auto</b> , <b>Kerberos</b> , or <b>NTLMv2</b> .   |
| <b>Username</b>                    | Type a user name (up to 96 characters) that has permission to write data to the folder specified in the <b>Network Folder Path</b> field. If the user name is part of a domain, enter the user name in one of the following styles: <ul style="list-style-type: none"> <li>• <b>user@domain</b></li> <li>• <b>domain\user</b></li> </ul> |
| <b>Password</b>                    | Type the password (up to 32 characters) associated with the user name you entered in the <b>Username</b> field. Type the password again in the <b>Retype password</b> field.   |
| <b>Kerberos Server Address</b>     | To set the Kerberos Server Address manually, type the Kerberos Server Address (for example: kerberos.example.com; up to 64 characters).  |

9. Click **Submit**.

10. You must configure the SNTP protocol (network time server) or set the date, time and time zone correctly on the control panel for all authentication methods. The machine's time must match the time used by the Kerberos Server and CIFS Server.



## Related Information

- [Scan to Network \(Windows\)](#)
  - [Set the Date and Time Using Web Based Management](#)

## Set the Date and Time Using Web Based Management

Make sure the date and time and the time zone settings are set correctly using Web Based Management or the control panel. The machine's time must match the time used by the server providing authentication.

Ignore step 1, if you already have a Web Based Management window open.

1. Start your web browser.
2. Type "https://machine's IP address" in your browser's address bar (where "machine's IP address" is the machine's IP address).

For example:

https://192.168.1.2

3. If required, type the password in the **Login** field, and then click **Login**.



The default password to manage this machine's settings is located on the back of the machine and marked "Pwd".

4. Click the **Administrator** tab.

5. Click the **Date&Time** menu in the left navigation bar.

## Date&Time

### Date

XX / XX / 20XX

### Clock Type

- 12h Clock  
 24h Clock

### Time

XX : XX PM

### Time Zone

UTC-XX:XX

### Auto Daylight

- Off  
 On

**Synchronize with SNTP server**

To synchronize the "Date&Time" with your SNTP server, you must configure the SNTP server settings.

[SNTP>>](#)

Cancel Submit

6. Clear the **Synchronize with SNTP server** checkbox.
7. In the **Date** fields, enter the date.
8. Select the clock type from the **Clock Type** field.
9. In the **Time** fields, enter the time.
10. Select the time difference between your location and UTC from the **Time Zone** drop-down list, for example, the time zone for Eastern time in the USA and Canada is UTC-05:00.
11. In the **Auto Daylight** field, click **On** to set the machine to change automatically for Daylight Saving Time. It will reset itself forward one hour in the spring, and back one hour in the autumn (available only for some countries).
12. Click **Submit**.



## Related Information

- [Set up a Scan to Network Profile](#)



## Upload Scanned Data to a CIFS Server

1. Load your document.
2. Press [Scan] > [to Network].



- If you registered your user ID, the [to My Folder] option appears when you log on to the machine using Active Directory Authentication or LDAP Authentication.
- To send scanned data to your designated folder on the CIFS server, press [to My Folder].
- To enable this feature in Web Based Management, click the **Scan** tab, and then click the **Scan to FTP / SFTP / Network / SharePoint** menu in the left navigation bar. In the **Send to My Folder** field, select **On**. Click **Submit**.

3. When the server profiles you set up using Web Based Management appear, select the profile you want. If the profile is not complete (for example, if the logon account name and password are missing, or if the quality or file type is not specified), you will be prompted to enter any missing information.



- If the LCD prompts you to enter a PIN for the computer, enter the four-digit PIN on the LCD, and then press [OK].

4. Press [Start].

The machine starts scanning. If using the machine's scanner glass, follow the touchscreen instructions to complete the scanning job.



### Related Information

- [Scan to Network \(Windows\)](#)

## Scan to SharePoint

Scan documents directly to a SharePoint server when you need to share the scanned information. For added convenience, configure different profiles to save your favourite Scan to SharePoint destinations.

- [Set up a Scan to SharePoint Profile](#)
- [Upload Scanned Data to a SharePoint Server](#)

## Set up a Scan to SharePoint Profile

Set up a Scan to SharePoint Profile to scan and upload the scanned data directly to a SharePoint location.

We recommend Microsoft Internet Explorer 11/Microsoft Edge for Windows, Safari 12/13 for Mac, Google Chrome™ for Android (4.x or later), and Google Chrome™/Safari for iOS (10.x or later). Make sure that JavaScript and Cookies are always enabled in whichever browser you use.

1. Start your web browser.
2. Type "https://machine's IP address" in your browser's address bar (where "machine's IP address" is the machine's IP address).

For example:

https://192.168.1.2

3. If required, type the password in the **Login** field, and then click **Login**.



The default password to manage this machine's settings is located on the back of the machine and marked "Pwd".

4. Click the **Scan** tab.
5. Click the **Scan to FTP / SFTP / Network / SharePoint** menu in the navigation bar.
6. Select the **SharePoint** option, and then click **Submit**.
7. Click the **Scan to FTP / SFTP / Network / SharePoint Profile** menu in the navigation bar.
8. Select the profile you want to set up or change.

### NOTE

Using the following characters: ?, /, \, ", :, <, >, | or \* may cause a sending error.

| Option                         | Description  |
|--------------------------------|--|
| <b>Profile Name</b>            | Type a name for this server profile (up to 15 alphanumeric characters). The machine will display this name on the LCD.   |
| <b>SharePoint Site Address</b> | Copy and paste the full destination address shown in the address bar of your browser (for example: http://SharePointSiteAddress/Shared%20Documents/Forms/AllItems.aspx) or the IP address (for example: http://192.168.0.1/Shared%20Documents/Forms/AllItems.aspx).  |
| <b>File Name</b>               | Select a file name prefix from the preset names provided, or from user-defined names. The file name used for the scanned document will be the file name prefix you select, followed by the last six digits of the flatbed/ADF scanner counter and the file extension (for example: "Estimate_098765.pdf"). |
| <b>Quality</b>                 | Select a quality setting. If you choose the <b>User Select</b> option, the machine will prompt users to select a setting each time they use the scan profile.  |
| <b>File Type</b>               | Select the file type you want to use for the scanned document. If you choose the <b>User Select</b> option, the machine will prompt users to select a setting each time they use the scan profile.   |
| <b>Document Size</b>           | Select your document size from the list. This is necessary to make sure the scanned file is the correct size.<br>If you choose the <b>User Select</b> option, the machine will prompt users to select a setting each time they use the scan profile.   |
| <b>File Size</b>               | Select your file size from the list.   |

| Option                             | Description  |
|------------------------------------|--|
|                                    | If you choose the <b>User Select</b> option, the machine will prompt users to select a setting each time they use the scan profile.  |
| <b>Auto Deskew</b>                 | Select <b>Auto</b> to set the machine to correct document skewing automatically as the pages are scanned.  |
| <b>Skip Blank Page</b>             | Select the <b>On</b> option to remove blank pages of the document from the scanning results.   |
| <b>Skip Blank Page Sensitivity</b> | Select the sensitivity level for detecting blank pages in the scanned data. The higher the sensitivity, the easier it is for the machine to detect blank pages.  |
| <b>2-sided Scan</b>                | Select <b>Long Edge</b> or <b>Short Edge</b> to scan both sides of the document, depending on the layout of your original.   |
| <b>Remove Background Colour</b>    | Change the amount of background colour that is removed.  |
| <b>Margin Settings</b>             | Adjust your document's margins.  |
| <b>Moire Reduction</b>             | Select <b>On</b> to reduce the moire pattern, or cross-hatching, in a scanned image.   |
| <b>Document Separation</b>         | Split a scanned image.<br>When multiple documents have been scanned, you can split and save the documents separately by using this function.   |
| <b>B&amp;W TIFF Compress</b>       | Select the TIFF compression option for a black and white document.   |
| <b>Brightness</b>                  | Select the brightness level.   |
| <b>Contrast</b>                    | Select the contrast level.   |
| <b>Use PIN for Authentication</b>  | To PIN-protect this profile, select <b>On</b> and type a four-digit PIN in the <b>PIN Code</b> field.  |
| <b>Auth. Method</b>                | To set your authentication method, select <b>Auto</b> , <b>NTLMv2</b> , <b>Kerberos</b> , or <b>Basic</b> . If you choose <b>Auto</b> , the authentication method will be detected automatically.  |
| <b>Username</b>                    | Type the user name (up to 96 characters) that has permission to write data to the folder specified in the <b>SharePoint Site Address</b> field. If the user name is part of a domain, enter the user name in one of the following styles: <ul style="list-style-type: none"> <li>• <b>user@domain</b></li> <li>• <b>domain\user</b></li> </ul> |
| <b>Password</b>                    | Type the password (up to 32 characters) associated with the user name you entered in the <b>Username</b> field. Type the password again in the <b>Retype password</b> field.   |
| <b>Kerberos Server Address</b>     | To set the Kerberos Server Address manually, type the Kerberos Server Address (for example: kerberos.example.com; up to 64 characters).  |

9. Click **Submit**.



## Related Information

- [Scan to SharePoint](#)

## Upload Scanned Data to a SharePoint Server

1. Load your document.
2. Press [Scan] > [to SharePoint].
3. When the server profiles you set up using Web Based Management appear, select the profile you want. If the profile is not complete (for example, if the logon account name and password are missing, or if the quality or file type is not specified), you will be prompted to enter any missing information.
4. Press [Start].

The machine starts scanning. If using the machine's scanner glass, follow the touchscreen instructions to complete the scanning job.



### Related Information

- [Scan to SharePoint](#)

## **Use the Web Services Protocol for Network Scanning (Windows 7, Windows 8.1, and Windows 10)**

The Web Services protocol enables Windows 7, Windows 8.1 and Windows 10 users to scan using a Brother machine on the network. You must install the driver via Web Services.

- [Use the Web Services Protocol to Install the Scanner Driver \(Windows 7, Windows 8.1, and Windows 10\)](#)
- [Scan From Your Machine Using the Web Services Protocol \(Windows 7, Windows 8.1 and Windows 10\)](#)
- [Configure Scan Settings for the Web Services Protocol](#)

## Use the Web Services Protocol to Install the Scanner Driver (Windows 7, Windows 8.1, and Windows 10)

- Make sure you have installed the correct software and drivers for your machine.
- Verify that the host computer and the Brother machine are on the same subnet, or that the router is correctly configured to pass data between the two devices.
- You must configure the IP address on your Brother machine before you configure this setting.

1. Do one of the following:

- Windows 10

Click  > **Windows System** > **Control Panel**. In the **Hardware and Sound** group, click **Add a device**.

- Windows 8.1

Move your mouse to the lower right corner of your desktop. When the menu bar appears, click **Settings** > **Change PC settings** > **PC and devices** > **Devices** > **Add a device**.

The machine's Web Services Name appears.

- Windows 7

Click  (**Start**) > **Control Panel** > **Network and Internet** > **View network computers and devices**.

The machine's Web Services Name appears with the printer icon.

Right-click the machine you want to install.



- The Web Services Name for the Brother machine is your model name and the MAC Address (Ethernet Address) of your machine (for example, Brother XXX-XXXX (where XXX-XXXX is the name of your model) [XXXXXXXXXXXX] (MAC Address / Ethernet Address)).

- Windows 8.1/Windows 10

Move your mouse over the machine name to display the machine's information.

2. Do one of the following:

- Windows 8.1/Windows 10

Select the machine you want to install, and then follow the on-screen instructions.

- Windows 7

Click **Install** in the displayed menu.



To uninstall the drivers, click **Uninstall** or  (**Remove device**).



### Related Information

- [Use the Web Services Protocol for Network Scanning \(Windows 7, Windows 8.1, and Windows 10\)](#)

## Scan From Your Machine Using the Web Services Protocol (Windows 7, Windows 8.1 and Windows 10)

If you have installed the scanner driver via Web Services, you can access the Web Services scanning menu on your machine's LCD.

Certain characters in the messages displayed on the LCD may be replaced with spaces if the language settings of your operating system and your machine are different.

1. Load your document.
2. Press [Scan] > [WS Scan].
3. Select the scan type.
4. Select the computer name where you want to send scanned data.
5. Press [Start].

The machine starts scanning.

If you are requested to select a scanning application, select Windows Fax and Scan or Windows Photo Gallery from the list.

### ✓ Related Information

- [Use the Web Services Protocol for Network Scanning \(Windows 7, Windows 8.1, and Windows 10\)](#)



## Configure Scan Settings for the Web Services Protocol

1. Do one of the following:

- Windows 10

Click  > **Windows System** > **Control Panel**. In the **Hardware and Sound** group, click **View devices and printers**.

- Windows 8.1

Move your mouse to the lower right corner of your desktop. When the menu bar appears, click **Settings**, and then click **Control Panel**. In the **Hardware and Sound** group, click **View devices and printers**.

- Windows 7

Click  (**Start**) > **Devices and Printers**.

2. Right-click the machine icon, and then select **Scan profiles....** The **Scan Profiles** dialog box appears.

3. Select the scan profile you want to use.

4. Make sure the scanner selected in the **Scanner** list is a machine that supports Web Services for scanning, and then click the **Set as Default** button.

5. Click **Edit...**

The **Edit Default Profile** dialog box appears.

6. Select the **Source**, **Paper size**, **Colour format**, **File type**, **Resolution (DPI)**, **Brightness** and **Contrast** settings.

7. Click the **Save Profile** button.

These settings will be applied when you scan using the Web Services protocol.

If the machine prompts you to select a scanning application, select Windows Fax and Scan from the list.

### Related Information

- [Use the Web Services Protocol for Network Scanning \(Windows 7, Windows 8.1, and Windows 10\)](#)

## Change the Scan Button Settings from Brother iPrint&Scan

Brother iPrint&Scan allows you to change the machine's Scan Button settings.

1. Start Brother iPrint&Scan.

- Windows

Launch  (Brother iPrint&Scan).

- Mac

In the **Finder** menu bar, click **Go > Applications**, and then double-click the iPrint&Scan icon.

The Brother iPrint&Scan screen appears.

2. If your Brother machine is not selected, click the **Select your Machine** button, and then follow the on-screen instructions to select your Brother machine.
3. Click the **Machine Scan Settings** button, and then follow the on-screen instructions to change the scan settings, such as document size, colour, and resolution.



### Related Information

- [Scan Using the Scan Button on Your Machine](#)

## Configure Certificates for Signed PDFs

If you select Signed PDF for Scan features, you must configure a certificate on your machine using Web Based Management.

To use Signed PDF, you must install a certificate on your machine and your computer.

1. Start your web browser.
2. Type "https://machine's IP address" in your browser's address bar (where "machine's IP address" is the machine's IP address).

For example:

https://192.168.1.2

3. If required, type the password in the **Login** field, and then click **Login**.



The default password to manage this machine's settings is located on the back of the machine and marked "Pwd".

4. Click the **Administrator** tab.
5. Click the **Signed PDF** menu in the left navigation bar.

The Signed PDF configuration dialog box appears.

### Signed PDF

#### Select the Certificate

(To use the Signed PDF, you need to configure the certificate.  
You can configure the certificate by clicking the link below.)

[Certificate>>](#)

6. Click the **Select the Certificate** drop-down list, and then select the certificate.
7. Click **Submit**.



## Related Information

- [Scan Using the Scan Button on Your Machine](#)
-

## Disable Scanning from Your Computer

To disable the scan function on your computer, disable the Pull Scan setting using Web Based Management.

1. Start your web browser.
2. Type "https://machine's IP address" in your browser's address bar (where "machine's IP address" is the machine's IP address).

For example:

https://192.168.1.2

3. If required, type the password in the **Login** field, and then click **Login**.



The default password to manage this machine's settings is located on the back of the machine and marked "Pwd".

4. Click the **Scan** tab.
5. Click the **Scan from PC** menu in the left navigation bar.
6. In the **Pull Scan** field, click **Disabled**.
7. Click **Submit**.



### Related Information

- [Scan Using the Scan Button on Your Machine](#)

## Scan from Your Computer (Windows)

There are several ways you can use your computer to scan photos and documents on your machine. Use the software applications we provide or use your favourite scanning application.

- [Scan Using Brother iPrint&Scan \(Windows/Mac\)](#)
- [Scan Using Nuance™ PaperPort™ 14SE or Other Windows Applications](#)
- [Scan Using Windows Fax and Scan](#)

## Scan Using Brother iPrint&Scan (Windows/Mac)

1. Start Brother iPrint&Scan.

- Windows

Launch  (Brother iPrint&Scan).

- Mac

In the **Finder** menu bar, click **Go > Applications**, and then double-click the iPrint&Scan icon.

The Brother iPrint&Scan screen appears.

2. If your Brother machine is not selected, click the **Select your Machine** button, and then select your model name from the list. Click **OK**.

3. Click **OK** again.

4. Click the **Scan** icon, and then follow the on-screen instructions to scan your documents.



### Related Information

- [Scan from Your Computer \(Windows\)](#)

#### Related Topics:

- [Brother iPrint&Scan](#)



## Scan Using Nuance™ PaperPort™ 14SE or Other Windows Applications

You can use the Nuance™ PaperPort™ 14SE application for scanning.

- To download the Nuance™ PaperPort™ 14SE application, click  (**Brother Utilities**), select **Do More** in the left navigation bar, and then click **PaperPort**.
- Nuance™ PaperPort™ 14SE supports Windows 7, Windows 8.1 and Windows 10.
- For detailed instructions on using each application, click the application's **Help** menu, and then click **Getting Started Guide** in the **Help** ribbon.



The instructions for scanning in these steps are for PaperPort™ 14SE. For other Windows applications, the steps will be similar. PaperPort™ 14SE supports both TWAIN and WIA drivers; the TWAIN driver (recommended) is used in these steps.

1. Load your document.
2. Start PaperPort™ 14SE.  
Do one of the following:
  - Windows 10  
Click  > **Nuance PaperPort 14** > **PaperPort**.
  - Windows 8.1  
Click  (**PaperPort**).
  - Windows 7  
Using your computer, click  (**Start**) > **All Programs** > **Nuance PaperPort 14** > **PaperPort**.
3. Click the **Desktop** menu, and then click **Scan Settings** in the **Desktop** ribbon.  
The **Scan or Get Photo** panel appears on the left side of the screen.
4. Click **Select**.
5. From the available Scanners list, select **TWAIN: TW-Brother XXX-XXXX** or **TWAIN: TW-Brother XXX-XXXX LAN** (where XXX-XXXX is the name of your model).
6. Click **OK**.
7. Select the **Display scanner dialog box** checkbox in the **Scan or Get Photo** panel.
8. Click **Scan**.  
The Scanner Setup dialog box appears.



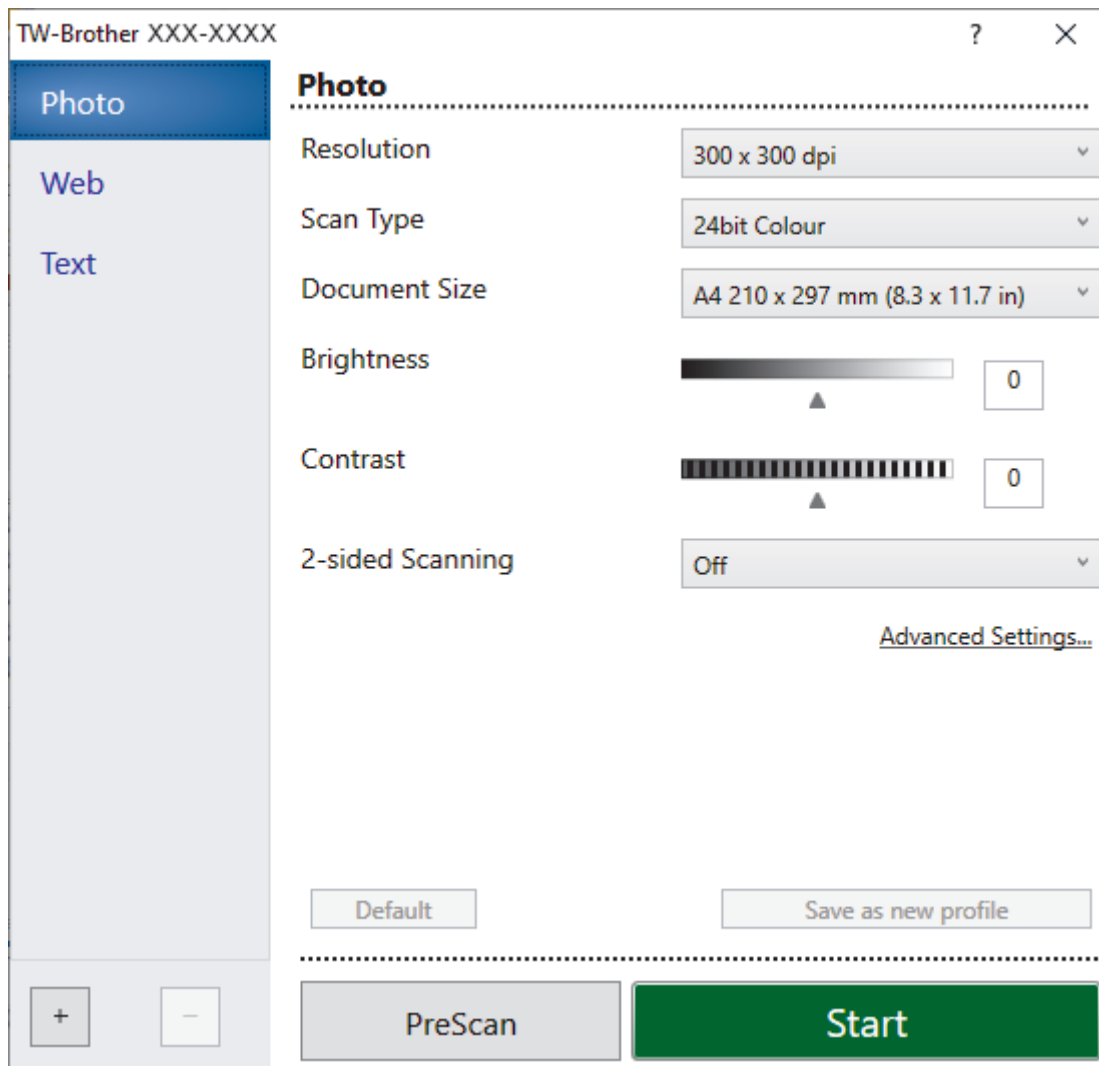

- Adjust the settings in the Scanner Setup dialog box, if needed.
- Click the **Document Size** drop-down list, and then select your document size.



To scan both sides of the document:  
Automatic 2-sided scan is available only when using the ADF.  
You cannot use PreScan to preview the scanned image.

- Click **PreScan** to preview your image and crop unwanted portions before scanning.
- Click **Start**.  
The machine starts scanning.



### Related Information

- [Scan from Your Computer \(Windows\)](#)
  - [TWAIN Driver Settings \(Windows\)](#)

## TWAIN Driver Settings (Windows)

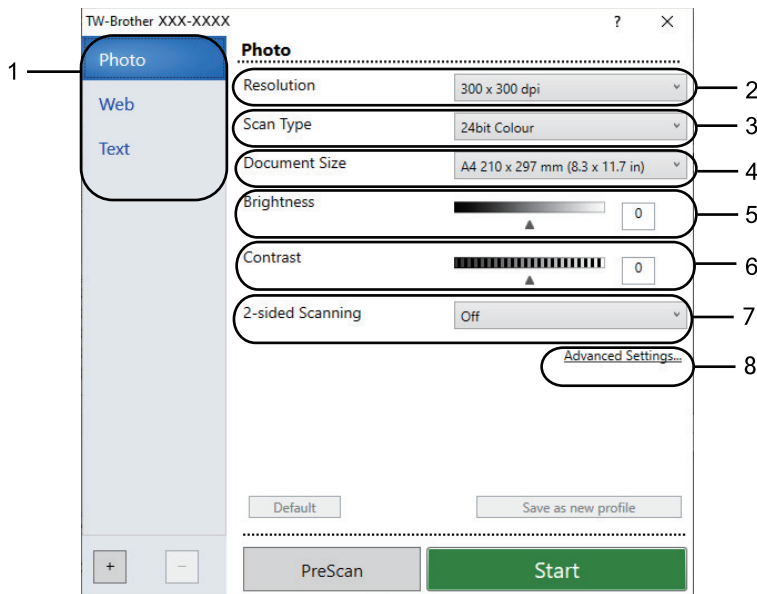

- Note that the item names and assignable values will vary depending on the machine.
- The **Contrast** option is available only when selecting the **Grey (Error Diffusion)**, **True Grey**, or **24bit Colour** options from the **Scan Type** settings.

### 1. Scan Type

Select the **Photo**, **Web**, or **Text** option depending on the type of document you want to scan.

| Scan (Image Type) |   | Resolution    | Scan Type                |
|-------------------|---|---------------|--------------------------|
| <b>Photo</b>      | Use for scanning photo images.                    | 300 x 300 dpi | <b>24bit Colour</b>      |
| <b>Web</b>        | Use for attaching the scanned image to web pages. | 100 x 100 dpi | <b>24bit Colour</b>      |
| <b>Text</b>       | Use for scanning text documents.                  | 200 x 200 dpi | <b>Black &amp; White</b> |

### 2. Resolution

Select a scanning resolution from the **Resolution** drop-down list. Higher resolutions take more memory and transfer time, but produce a finer scanned image.

### 3. Scan Type

Select from a range of scan colour depths.

- Black & White**  
Use for text or line art images.
- Grey (Error Diffusion)**  
Use for photographic images or graphics. (Error Diffusion is a method for creating simulated grey images without using true grey dots. Black dots are put in a specific pattern to give a grey appearance.)
- True Grey**  
Use for photographic images or graphics. This mode is more accurate because it uses up to 256 shades of grey.
- 24bit Colour**  
Use to create an image with the most accurate colour reproduction. This mode uses up to 16.8 million colours to scan the image, but it requires the most memory and has the longest transfer time.

---

#### 4. Document Size

Select the exact size of your document from a selection of preset scan sizes.

If you select **Custom**, the **Custom Document Size** dialog box appears and you can specify the document size.

#### 5. Brightness

Set the **Brightness** level by dragging the slider to the right or left to lighten or darken the image. If the scanned image is too light, set a lower brightness level and scan the document again. If the image is too dark, set a higher brightness level and scan the document again. You can also type a value in the field to set the brightness level.

#### 6. Contrast

Increase or decrease the **Contrast** level by moving the slider to the right or left. An increase emphasises dark and light areas of the image, while a decrease reveals more details in grey areas. You can also type a value in the field to set the contrast level.

#### 7. 2-sided Scanning

Scan both sides of the document. When using the Automatic 2-sided Scan feature, you must select the **Long-edge binding** or **Short-edge binding** option from the **2-sided Scanning** drop-down list, so when you turn the pages, they are facing the way you want.

#### 8. Advanced Settings

Configure advanced settings by clicking the **Advanced Settings** button in the Scan Settings dialog box.

- **Document Correction**

- **Auto Deskew**

- Set the machine to correct document skewing automatically as the pages are scanned.

- **Margin Settings**

- Adjust the margins in your document.

- **Rotate Image**

- Rotate the scanned image.

- **Edge Fill**

- Fill in the edges on four sides of the scanned image using the selected colour and range.

- **Skip Blank Page**

- Remove the document's blank pages from the scanning results.

- **Image Quality**

- **Background Processing**

- **Remove Bleed-through / Pattern**

- Prevent bleed-through.

- **Remove Background Colour**

- Remove the base colour of documents to make the scanned data more legible.

- **Colour Drop**

- Select a colour to remove from the scanned image.

- **Edge Emphasis**

- Make the characters of the original sharper.

- **Reduce Noise**

- Improve and enhance the quality of your scanned images with this selection. The **Reduce Noise** option is available when selecting the **24bit Colour** option and the **300 x 300 dpi**, **400 x 400 dpi**, or **600 x 600 dpi** scan resolution.

- **Moire Reduction**

- Improve and enhance the quality of your scanned images. The **Moire Reduction** option is available when selecting the **100 x 100 dpi**, **150 x 150 dpi**, **200 x 200 dpi**, or **300 x 300 dpi** scan resolution.

- **B&W Image Quality**

- **Character Correction**

- 
- **Blurred Character Correction**  
Correct the broken or incomplete characters of the original to make them easier to read.
  - **Boldface Formatting**  
Emphasise the characters of the original by making them bold.
  - **B&W Inversion**  
Invert black and white in the monochrome image.
  - **Feed Control**
    - **Layout**  
Select the layout.
    - **Continuous Scan**  
Select this option to scan multiple pages. After a page is scanned, select whether to continue scanning or finish.



## Related Information

- [Scan Using Nuance™ PaperPort™ 14SE or Other Windows Applications](#)
-

## Scan Using Windows Fax and Scan

The Windows Fax and Scan application is another option that you can use for scanning.

- Windows Fax and Scan uses the WIA scanner driver.
- If you want to crop a portion of a page after pre-scanning the document, you must scan using the scanner glass (also called the flatbed).

1. Load your document.
2. Launch Windows Fax and Scan.
3. Click **File > New > Scan**.
4. Select the scanner you want to use.
5. Click **OK**.

The **New Scan** dialog box appears.

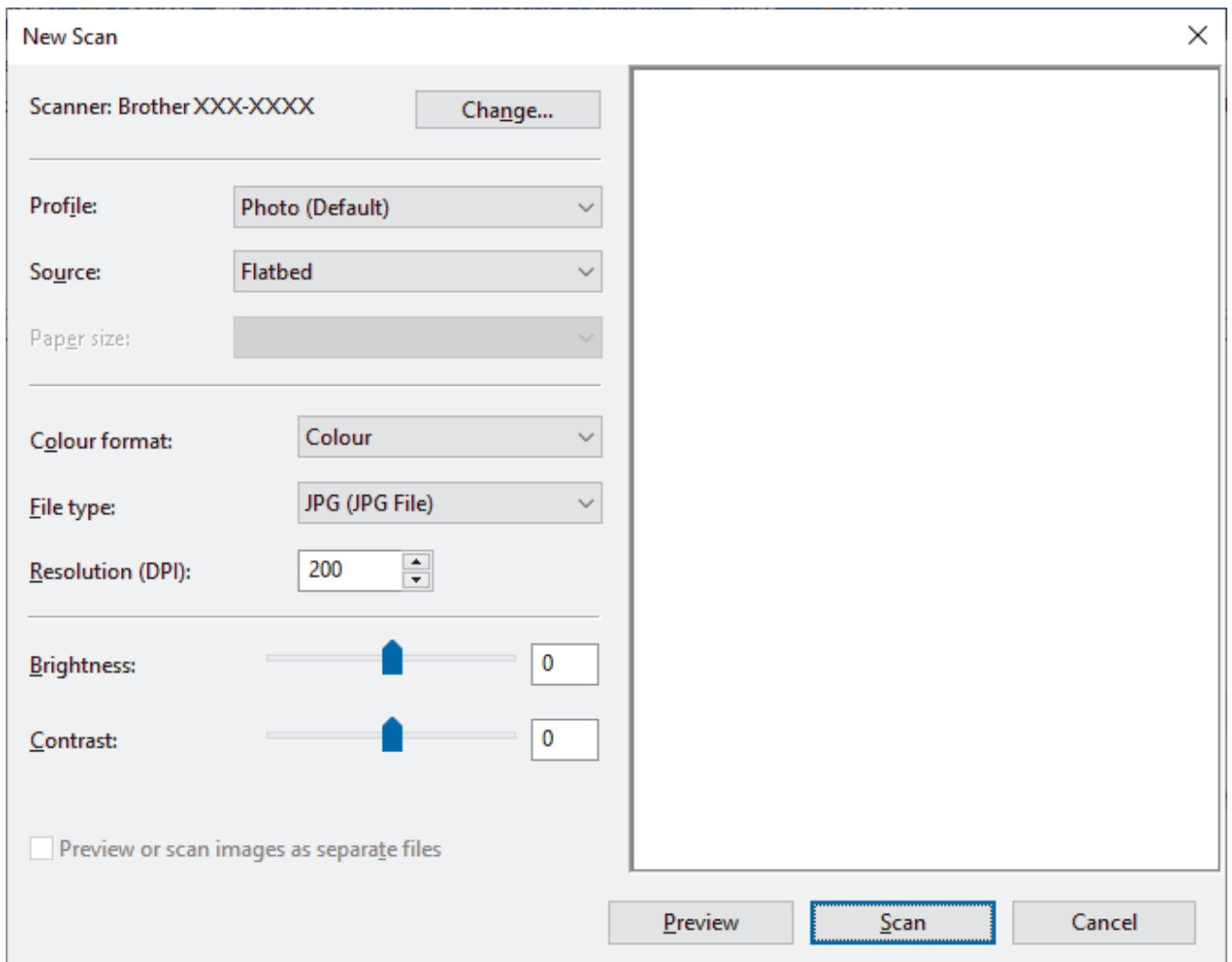

6. Adjust the settings in the dialog box, if needed.

The scanner resolution can be set to a maximum of 1200 dpi. If you want to scan at higher resolutions, use the **Scanner Utility** software from **Brother Utilities**.

If your machine supports 2-sided Scan and you want to scan both sides of your document, select **Feeder (Scan both sides)** as **Source**.

7. Click **Scan**.

The machine starts scanning the document.



## Related Information

- [Scan from Your Computer \(Windows\)](#)
  - [WIA Driver Settings \(Windows\)](#)
-

## WIA Driver Settings (Windows)

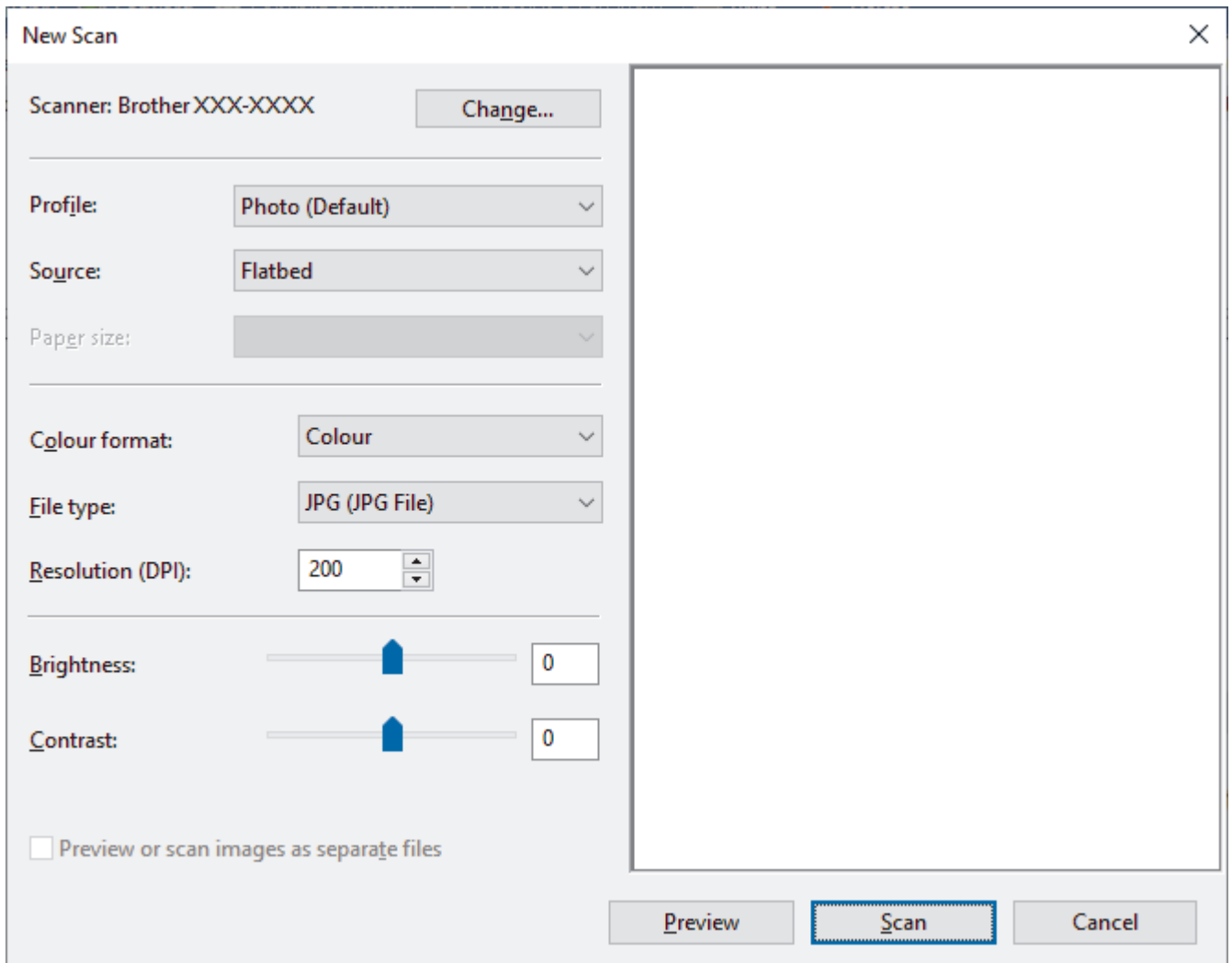

### Profile

Select the scan profile you want to use from the **Profile** drop-down list.

### Source

Select the **Flatbed**, **Feeder (Scan one side)**, or **Feeder (Scan both sides)** option from the drop-down list.

### Paper size

The **Paper size** option is available if you select the **Feeder (Scan one side)** or **Feeder (Scan both sides)** option from the **Source** drop-down list.

### Colour format

Select a scan colour format from the **Colour format** drop-down list.

### File type

Select a file format from the **File type** drop-down list.

### Resolution (DPI)

Set a scanning resolution in the **Resolution (DPI)** field. Higher resolutions take more memory and transfer time, but produce a finer scanned image.

### Brightness

Set the **Brightness** level by dragging the slider to the right or left to lighten or darken the image. If the scanned image is too light, set a lower brightness level and scan the document again. If the image is too dark,

---

set a higher brightness level and scan the document again. You can also type a value in the field to set the brightness level.

### **Contrast**

Increase or decrease the **Contrast** level by moving the slider to the right or left. An increase emphasises dark and light areas of the image, while a decrease reveals more details in grey areas. You can also type a value in the field to set the contrast level.



### **Related Information**

- [Scan Using Windows Fax and Scan](#)



## Scan from Your Computer (Mac)

- [Scan Using Brother iPrint&Scan \(Windows/Mac\)](#)
- [Scan Using AirPrint \(macOS\)](#)

## Configure Scan Settings Using Web Based Management

- [Set the Scan File Name Using Web Based Management](#)
- [Set the Scan Job Email Report Using Web Based Management](#)

## Set the Scan File Name Using Web Based Management

Set up a file name for scanned data using Web Based Management.

1. Start your web browser.
2. Type "https://machine's IP address" in your browser's address bar (where "machine's IP address" is the machine's IP address).

For example:

https://192.168.1.2

3. If required, type the password in the **Login** field, and then click **Login**.



The default password to manage this machine's settings is located on the back of the machine and marked "Pwd".

4. Go to the navigation menu, and then click **Scan > Scan File Name**.



Start from , if the navigation menu is not shown on the left side of the screen.

5. Select the **File Name Style** from the drop-down list.
6. If you selected the option to include the date in **File Name Style** field, select the **Date** format from the drop-down list.
7. In the **Time** field, select **On** to include the time information in the file name.
8. In the **Counter** field, select **Continuous** or **Reset after each job**.



When you select **Reset after each job**, duplication of file names may occur.

9. If you want to create a user-defined file name prefix, type a file name in the user-defined fields of each scan function.



Do not use the following characters: ? / \ \*

10. Click **Submit**.



### Related Information

- [Configure Scan Settings Using Web Based Management](#)

## Set the Scan Job Email Report Using Web Based Management

When you scan a document, the machine will send a scan job email report automatically to the registered email address.

1. Start your web browser.
2. Type "https://machine's IP address" in your browser's address bar (where "machine's IP address" is the machine's IP address).

For example:

https://192.168.1.2

3. If required, type the password in the **Login** field, and then click **Login**.



The default password to manage this machine's settings is located on the back of the machine and marked "Pwd".

4. Go to the navigation menu, and then click **Scan > Scan Job e-mail report**.



Start from ☰, if the navigation menu is not shown on the left side of the screen.

5. In the **Administrator Address** field, type the email address.
6. For the scan functions you want, select **On** to send a scan job email report.
7. Click **Submit**.



### Related Information

- [Configure Scan Settings Using Web Based Management](#)

## Copy

- [Copy on One Side of the Paper \(1-sided\)](#)
- [Copy on Both Sides of the Paper \(2-sided\)](#)
- [Enlarge or Reduce Copied Images](#)
- [Make N in 1 Copies Using the Page Layout Feature](#)
- [Interrupt a Print Job with a Copy Job](#)
- [Copy an ID Card](#)
- [Copy Options](#)

## Copy on One Side of the Paper (1-sided)

1. Make sure you have loaded the correct size paper in the paper tray.
2. Do one of the following:
  - Place the document *face up* in the ADF.  
(If you are copying multiple pages, we recommend using the ADF.)

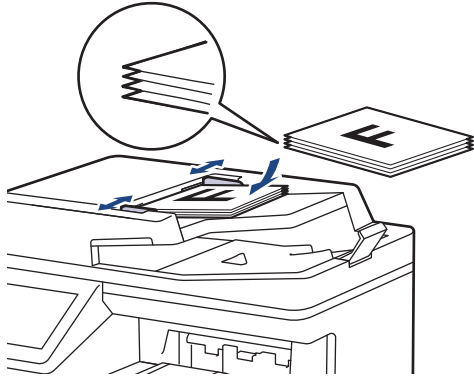

- Place the document *face down* on the scanner glass.

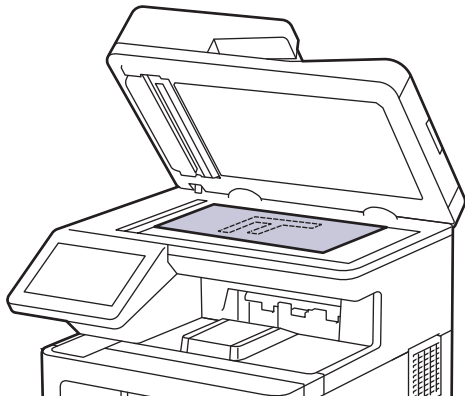

### NOTE

For important or fragile documents, use the machine's scanner glass.

3. Press  [Copy].

The LCD displays:

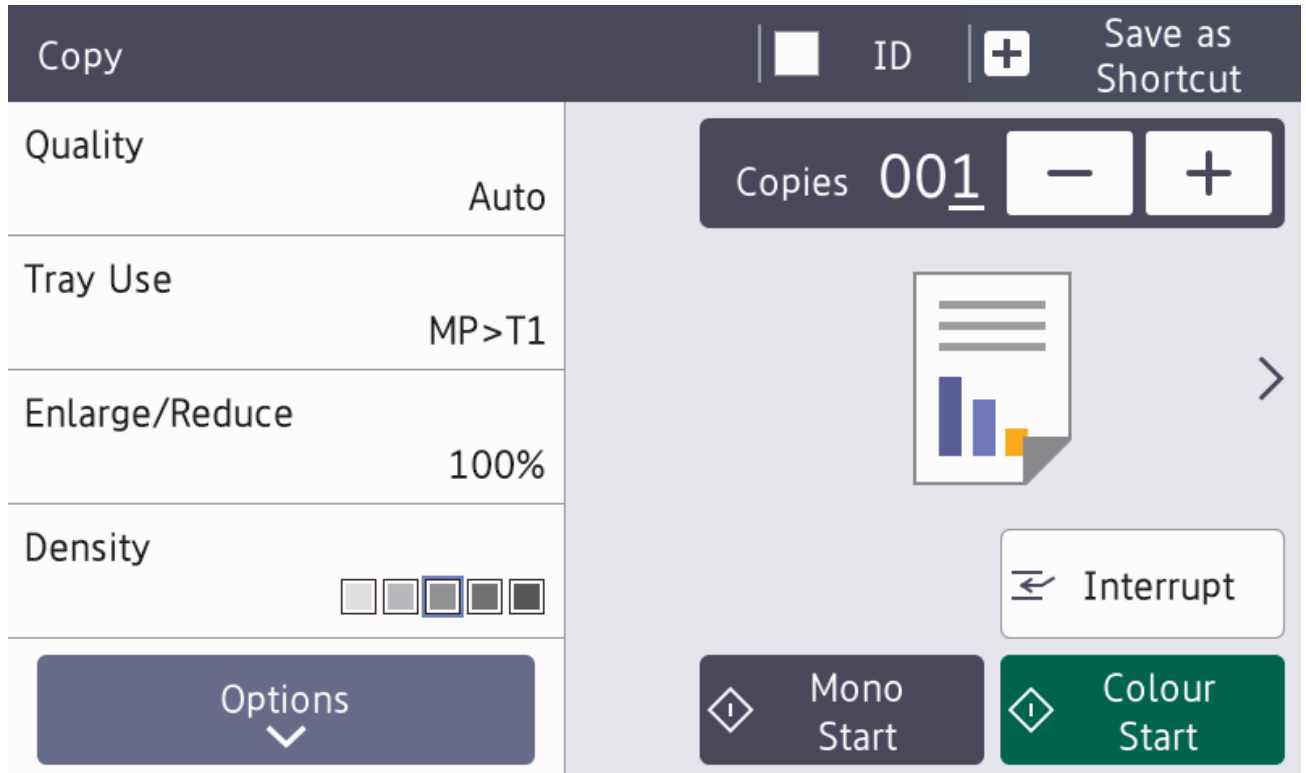

4. Change the copy settings, if needed.

- **001** (Number of copies)

Enter the number of copies in one of the following ways:

- Press  or  on the LCD.

- Press **001** to display a numeric keypad on the LCD, and then enter the number of copies. Press [OK].

- [Options]

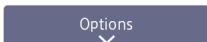
Press  to change the copy settings for the next copy only.

- When finished, press [OK]. (If the [OK] button is displayed.)

- After you have finished choosing new options, you can save them by pressing the [Save as Shortcut] button.



- Quick Copy

Press > to access the preset copy settings.

- Current setting

Press the following display area to change these settings for the next copy only.

- [Quality]

- [Tray Use]

- [Enlarge/Reduce]

- [Density]

- [2-sided Copy]

- [Contrast]

---

5. Press [Colour Start] or [Mono Start].



To stop copying, press .



### Related Information

- [Copy](#)
-



## Copy on Both Sides of the Paper (2-sided)

Reduce the amount of paper you use by copying onto both sides of the paper.

- You must choose a 2-sided copy layout from the following options before you can start 2-sided copying.
- The layout of your original document determines which 2-sided copy layout you should choose.
- For important or fragile documents, use the machine's scanner glass.
- To use the automatic 2-sided copy feature, you must load your document in the ADF.
- When you manually make 2-sided copies from a 2-sided document, use the scanner glass.
- Select A4, A4 Short (270mm Paper), Letter, Legal, Mexico Legal, India Legal, or Folio sized paper when using the 2-sided copy option.
- Make sure the 2-sided tray is set to the correct paper size. If it is not, the paper may not be fed correctly, resulting in a skewed printout or a paper jam.

### Portrait

#### 2-sided to 2-sided

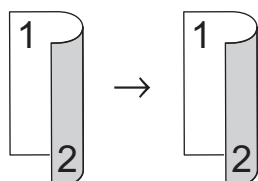

#### 1-sided to 2-sided (Long Edge Flip)

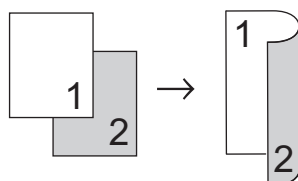

#### 1-sided to 2-sided (Short Edge Flip)

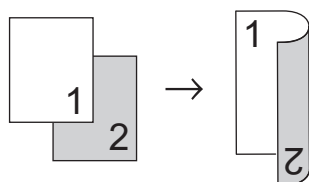

### Landscape

#### 2-sided to 2-sided

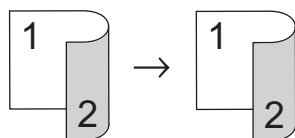

#### 1-sided to 2-sided (Long Edge Flip)

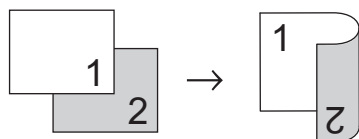

#### 1-sided to 2-sided (Short Edge Flip)

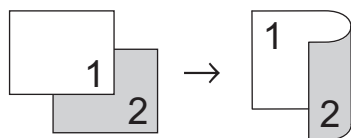

1. Load your document.

## NOTE

Load your 2-sided document in the ADF. If you use the scanner glass for your 2-sided document, select the [1-sided⇒2-sided] option.

2. Press  [Copy].
3. Enter the number of copies.
4. Press [Options] > [2-sided Copy].
5. Do one of the following:
  - To make 2-sided copies of a 2-sided document, press [2-sided⇒2-sided].
  - To make 2-sided copies from a 1-sided document, follow these steps:
    - a. To change the layout options, press [Layout], and then press [Long Edge Flip] or [Short Edge Flip].
    - b. Press [1-sided⇒2-sided].
6. When finished, press [OK]. (If the [OK] button is displayed.)
7. Press [Colour Start] or [Mono Start].

If you placed the document in the ADF, the machine scans the pages and starts printing.

8. **If you are using the scanner glass, repeat the following steps for each page of the document:**



For a 2-sided document, turn the sheet over along the long edge to scan the other side.

- Place the next page on the scanner glass, and then press [Continue] to scan the page.
- After scanning all the pages, press [Finish].







### Related Information

- [Copy](#)

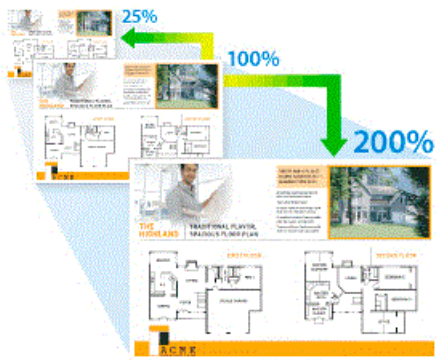
## Enlarge or Reduce Copied Images

Select an enlargement or reduction ratio to resize your copied data.



1. Load your document.
2. Press  [Copy].
3. Enter the number of copies.
4. Press [Options] > [Enlarge/Reduce].
5. Press the option you want.
6. Do one of the following:
  - If you select [Enlarge] or [Reduce], press the enlargement or reduction ratio you want to use.
  - If you select [Custom(25-400%)], press  (backspace) to erase the displayed percentage, or press  to move the cursor, and then enter an enlargement or reduction ratio from [25] to [400].  
Press [OK].
  - If you selected [100%], go to the next step.
7. When finished, press [OK]. (If the [OK] button is displayed.)
8. Press [Colour Start] or [Mono Start].

### Related Information





- [Copy](#)

## Make N in 1 Copies Using the Page Layout Feature

The N in 1 copy feature saves paper by copying two or four pages of your document onto one page of the copy.



1. Load your document.
2. Press  [Copy].
3. Enter the number of copies.
4. Press [Options] > [Page Layout].
5. Swipe up or down or press ▲ or ▼ to display the options, and then press the option you want.

| Option           | Description   |
|------------------|---|
| 2in1 (Portrait)  |  |
| 2in1 (Landscape) |  |
| 4in1 (Portrait)  |  |
| 4in1 (Landscape) |  |

6. When finished, press [OK]. (If the [OK] button is displayed.)
7. Press [Colour Start] or [Mono Start].  
If you placed the document in the ADF, the machine scans the pages and starts printing.
8. **If you are using the scanner glass, repeat the following steps for each page of the document:**
  - Place the next page on the scanner glass, and then press [Continue] to scan the page.
  - After scanning all the pages, press [Finish].

### ✓ Related Information

- [Copy](#)

## Interrupt a Print Job with a Copy Job

Interrupt the current print job to make urgently needed copies.

### NOTE

This function cannot interrupt the printing of received faxes. The machine can interrupt the following jobs:

- Print jobs from your computer or mobile devices
- Copy jobs

1. Load your document.

2. Press  [Copy].

3. Enter the number of copies.

4. Press [Interrupt].

5. Press [Colour Start] or [Mono Start].

If you placed the document in the ADF, the machine scans the pages and starts printing.

6. **If you are using the scanner glass, repeat the following steps for each page of the document:**

- Place the next page on the scanner glass, and then press [Continue] to scan the page.
- After scanning all the pages, press [Finish].

7. After the machine has printed your copies, press [Interrupt] to resume the interrupted print job.



### Related Information

- [Copy](#)

## Copy an ID Card



You may copy an identification card only to the extent permitted under applicable laws. For more detailed information, see the *Product Safety Guide*.

1. Place your identification card *face down* near the upper left corner of the scanner glass.

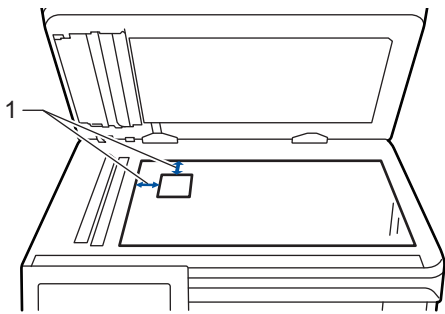

1: Distance 4.0 mm or greater (top, left)

2. Press  [Copy].
3. Press > on the touchscreen, and then select [2in1 (ID)].
4. Enter the number of copies.
5. Press [Colour Start] or [Mono Start].  
The machine scans one side of the identification card.
6. After the machine has scanned the first side, turn over the identification card.

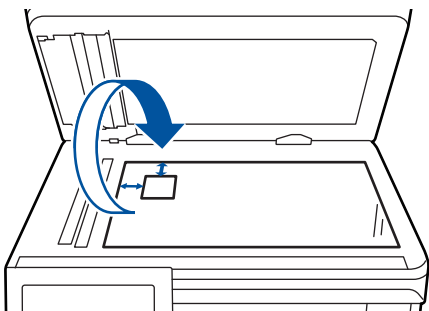

7. Press [Continue] to scan the other side.

### ✓ Related Information

- [Copy](#)

# Copy Options

To change the Copy options, press [Options].

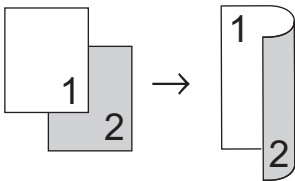
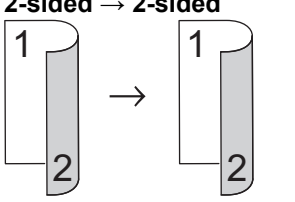
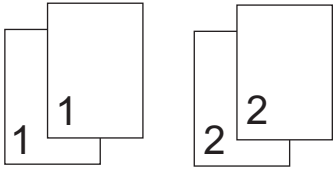
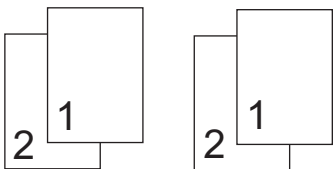
| Menu selections  | Options   |  |
|--|---|--|
| Quality  | Select the copy quality for your type of document.  |  |
| Tray Use   | Select a paper tray for the next copy.  |  |
| Enlarge/Reduce   | 100%  | -  |
|  | Enlarge   | Select an enlargement ratio for the next copy. |
|  | Reduce  | Select a reduction ratio for the next copy.    |
|  | Custom (25-400%)  | Enter an enlargement or reduction ratio.       |
| Density  | Increase the density to make the text darker.<br>Decrease the density to make the text lighter.   |  |
| Remove Background Colour                                     | Select to remove the background colour of the document when copying.  |  |
| 2-sided Copy   | Select to copy on both sides of the paper.<br><b>1-sided → 2-sided</b><br><br><b>2-sided → 2-sided</b><br><br>The available options will vary depending on your model. |  |
| 2-sided Copy Page Layout<br>(available for certain settings) | Select long edge binding or short edge binding.   |  |
| Contrast   | Increase the contrast to make an image clearer.<br>Decrease the contrast to make an image more subdued.   |  |
| Stack/Sort   | Select to stack or sort multiple copies.<br><b>Stack</b><br><br><b>Sort</b><br>   |  |

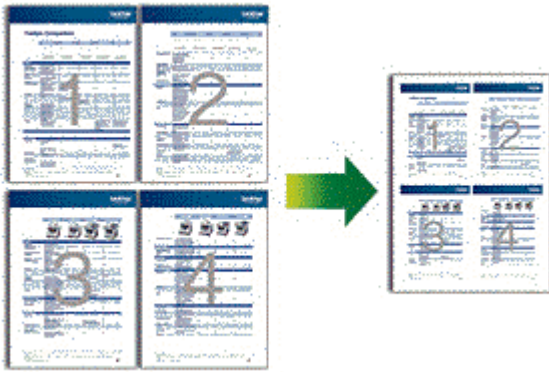
| Menu selections | Options   |
|-----------------|---|
| Page Layout     | Make N in 1 copies.<br><b>4 in1</b><br> |
| Auto Deskew     | Set the machine to automatically correct skewed copies.   |
| Colour Adjust   | Change the default setting for colour saturation.   |



### Related Information

- [Copy](#)



## Fax

- [Send a Fax](#)
- [Receive a Fax](#)
- [Voice Operations and Fax Numbers](#)
- [Telephone Services and External Devices](#)
- [Fax Reports](#)
- [PC-FAX](#)

## Send a Fax

- [Send a Fax](#)
- [Send a 2-sided Fax from the ADF](#)
- [Send a Fax Manually](#)
- [Send a Fax at the End of a Conversation](#)
- [Send the Same Fax to More than One Recipient \(Broadcasting\)](#)
- [Send a Fax in Real Time](#)
- [Send a Fax at a Specified Time \(Delayed Fax\)](#)
- [Add a Cover Page to Your Fax](#)
- [Cancel a Fax in Progress](#)
- [Check and Cancel a Pending Fax](#)
- [Fax Options](#)

## Send a Fax

1. Do one of the following:

- Place the document *face up* in the ADF.  
(If you are faxing multiple pages, we recommend using the ADF.)

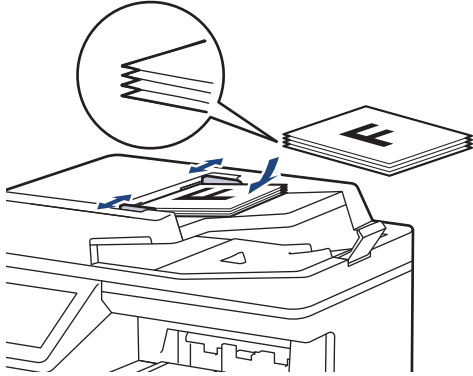

- Place the document *face down* on the scanner glass.

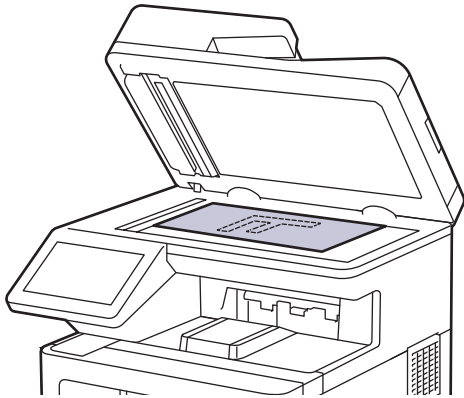

2. Press  [Fax].

3. Do one of the following:

- If Fax Preview is set to [Off], press [Fax].
- If Fax Preview is set to [On], press [Fax], and then press [Sending Faxes].

4. Enter the fax number.

- Using the dial pad**

Press the digits to enter the fax number.



- Using the Address Book**

Press  [Address Book], and then do one of the following:

- Swipe up or down or press ▲ or ▼ to display the number you want, and then press it.
- Press  [Search], and then enter the name and press [OK]. Press the name you want to dial.

When finished, press [Apply].

---

- **Using the call history**

Press  [Call History], and then press the [Outgoing Call] option.

Swipe up or down or press ▲ or ▼ to display the fax number you want, and then press it.

To send a fax, press [Apply].

5. Press [Fax Start].

The machine scans and sends the document.

**If you placed the document on the scanner glass, follow the instructions in the table.**

| Option | Description   |
|--------|---|
| Yes    | To scan the next page, press the Yes option, and then place the next page on the scanner glass.<br>Press OK to scan the page. |
| No     | After you have scanned the last page, press the No option.<br>The machine sends the document.                                 |

To stop faxing, press , and then press .

When the LCD displays [Cancel Job?], press [Yes].

### Related Information

- [Send a Fax](#)
-

## Send a 2-sided Fax from the ADF

You must select a 2-sided scanning format before sending a 2-sided fax. Select either Long Edge or Short Edge, depending on the layout of your document.

1. Load your document.
2. Press  [Fax] > [Options] > [2-sided Fax].
3. Do one of the following:
  - If your document is flipped on the Long edge, press the [2-sided Scan: Long Edge] option.
  - If your document is flipped on the Short edge, press the [2-sided Scan: Short Edge] option.
4. Press [OK]. (If the [OK] button is displayed.)



If the [OK] button is not displayed after setting the time, press  to return to the fax sending screen.

5. Enter the fax number.
6. Press [Fax Start].



### Related Information

- [Send a Fax](#)

## Send a Fax Manually

Manual fax transmission lets you hear the dialling, ringing and fax-receiving tones while sending a fax.

1. Load your document.
2. Press  [Fax].
3. Pick up the handset of the external telephone.
4. Dial the fax number you want to call.
5. When you hear the fax tone, press [Fax Start].  
If you are using the scanner glass, press [Send].
6. Pick up the handset of the external telephone and listen for a dial tone.



### Related Information

- [Send a Fax](#)

## Send a Fax at the End of a Conversation

At the end of a conversation, you can send a fax to the other party before you both hang up.

1. Ask the other party to wait for fax tones (beeps) and then to press the Start key before hanging up.
2. Load your document.
3. Press [Fax Start].  
If you are using the scanner glass, press [Send].
4. Replace the handset of an external telephone.



### Related Information

- [Send a Fax](#)
-

## Send the Same Fax to More than One Recipient (Broadcasting)

Use the Broadcasting feature to send the same fax to multiple fax numbers at the same time.

- The same broadcast can include Groups, Address Book numbers, and up to 50 manually dialed numbers.
- Address Book numbers must be stored in the machine's memory before they can be used in a broadcast.
- Group numbers must also be stored in the machine's memory before they can be used in a broadcast. Group numbers include many stored Address Book numbers for easier dialling.



If you did not use any of the Address Book numbers for Groups, you can broadcast faxes to as many as 350 different numbers.

1. Load your document.
2. Press  [Fax] > [Options] > [Broadcasting].
3. Press [Add Number].

You can add numbers to the broadcast in the following ways:

- Press [Add Number] and enter a number using the LCD.  
Press [OK].





If you want to broadcast using an email address, press , enter the email address, and press [OK].

(On certain models, you must download Internet Fax to use the Internet Fax feature and the Scan to Email server feature.)

- Press [Add from Address book]. Swipe up or down or press ▲ or ▼ to display the number you want to add to the broadcast. Select the checkboxes of the broadcast. After you select all the numbers you want, press [OK].
  - Press [Search in Address book]. Press the name and press [OK]. Press the name, and then press the number you want to add.
4. When finished, press [OK].



If your machine displays , press , and then press .

5. Press [Fax Start].



- The machine's available memory will vary depending on the types of jobs in the memory and the numbers used for broadcasting. If you broadcast to the maximum number available, you will not be able to use dual access and delayed fax.
- If the [Out of Memory] message appears, press  or [Quit] to stop the job. If more than one page has been scanned, press [Send Now] to send the portion that is in the machine's memory.





### Related Information

- [Send a Fax](#)
  - [Cancel a Broadcast in Progress](#)



## Cancel a Broadcast in Progress

While broadcasting multiple faxes, you can cancel just the fax currently being transmitted or cancel the whole broadcast job.

1. Press .
2. Press .
3. Do one of the following:
  - To cancel the entire broadcast, press [Entire Broadcast].  
When the LCD displays [Cancel Job?], press [Yes].
  - To cancel the current job, press the name or number being dialled on the LCD.  
When the LCD displays [Cancel Job?], press [Yes].
  - To exit without cancelling, press .



### Related Information

- [Send the Same Fax to More than One Recipient \(Broadcasting\)](#)

## Send a Fax in Real Time

When sending a fax, the machine scans the document into the memory before sending it. As soon as the telephone line is free, the machine starts dialling and sending. If you want to send an important document immediately without waiting for the machine to retrieve the scan from its memory, turn on [Real Time TX].

- If the memory is full and you are sending a fax from the ADF, the machine sends the document in real time (even if [Real Time TX] is set to [Off]). If the memory is full, faxes from the scanner glass cannot be sent until you clear some of the memory.
- In Real Time Transmission, the automatic redial feature does not work when using the scanner glass.
- If [Real Time TX] is set to on, the option to scan 2-sided documents is not available.

1. Load your document.
2. Press  [Fax] > [Options] > [Real Time TX].
3. Press [On] or [Off].
4. Press [OK]. (If the [OK] button is displayed.)
5. Enter the fax number.
6. Press [Fax Start].

### Related Information

- [Send a Fax](#)

## Send a Fax at a Specified Time (Delayed Fax)

You can store up to 50 faxes in the machine's memory to be sent within the next twenty-four hour period.



1. Load your document.
2. Press  [Fax] > [Options] > [Delayed Fax] > [Delayed Fax].
3. Press [On].
4. Press [Set Time].
5. To enter the time you want the fax to be sent, do one of the following:
  - If you set [12h Clock] in the [Clock Type] setting, enter the time in 12-hour format. Press [AM] or [PM], and then press [OK].

### NOTE

If your machine displays , press , and then press .

- If you set [24h Clock] in the [Clock Type] setting, enter the time in 24-hour format and then press [OK].  
(For example, enter 19:45 for 7:45 PM.)

### NOTE

If your machine displays , press , and then press .

6. Press [OK].



If the [OK] button is not displayed after setting the time, press  to return the fax sending screen.

7. Enter the fax number.
8. Press [Fax Start].
9. Press .



### ✓ Related Information

- [Send a Fax](#)

## Add a Cover Page to Your Fax

You can add a cover page to the next fax or every outgoing fax.

- This feature will not work unless you have set up your Station ID.
- Your cover page includes your Station ID, a comment, and the name stored in the Address Book.

1. Load your document.
2. Press  [Fax] > [Options] > [Coverpage Setup] > [Coverpage Setup].
3. Press [On].
4. Press [Coverpage Note].
5. Swipe up or down or press ▲ or ▼ to choose the comment you want to use, and then press the comment.  
Press .
6. Press [OK]. (If the [OK] button is displayed.)
7. Enter the fax number.
8. Press [Fax Start].

The cover page will be added to the next fax. If you want to add the cover page to every outgoing fax, set the settings as the new default.



### Related Information

- [Send a Fax](#)
- [Create a Cover Page Message](#)

## Create a Cover Page Message

Create up to two custom cover page messages to add to outgoing faxes.

1. Press  [Settings] > [All Settings] > [Fax] > [Setup Send] > [Coverpage Note].



If your machine displays the [All Settings] menu on the Home screen, skip the [Settings] menu.

2. Press [5.] or [6.] to store your customised message.
3. Enter the cover page message using the LCD. Press [OK].

Press  to select numbers, letters, or special characters.



If your machine displays   #+= , press   #+= .



4. Press .



### Related Information

- [Add a Cover Page to Your Fax](#)

## Cancel a Fax in Progress

1. Press .
2. Press  while the machine is dialling or sending a fax.  
The LCD displays [Cancel Job?].
3. Press an option in the table to cancel or continue the fax job in progress.

| Option | Description  |
|--------|--|
| Yes    | The machine cancels sending the fax job.                           |
| No     | The machine exits from the process without cancelling the fax job. |

### Related Information

- [Send a Fax](#)

## Check and Cancel a Pending Fax

You can cancel a fax job before it is sent, while it is stored in the memory.

1. Press  [Settings] > [All Settings] > [Fax] > [Remaining Jobs].



If your machine displays the [All Settings] menu on the Home screen, skip the [Settings] menu.

2. Swipe up or down or press ▲ or ▼ to scroll through the waiting jobs, and then press the job you want to cancel.
3. Press [Cancel].
4. Press [Yes] to cancel the fax job or press [No] to exit without cancelling.
5. When finished cancelling jobs, press .



### Related Information

- [Send a Fax](#)

## Fax Options

To change the fax-sending settings, press the [Options] button.

| Option   | Description   |
|--|---|
| Fax Resolution   | Set the resolution for outgoing faxes.<br>The fax quality often can be improved by changing the Fax Resolution.         |
| Contrast   | Adjust the contrast.<br>If your document is very light or very dark, changing the contrast may improve the fax quality. |
| 2-sided Fax<br>(For automatic 2-sided scanning models) | Set the 2-sided scanning format.  |
| Glass Scan Size  | Adjust the scan area of the scanner glass to the size of the document.  |
| Broadcasting   | Send the same fax message to more than one fax number at the same time.   |
| Preview  | Preview a fax message before you send it.   |
| Delayed Fax  | Set the time of day the delayed faxes will be sent.   |
| Real Time TX   | Send a fax immediately without waiting for the machine to retrieve the scan from its memory.                            |
| Coverpage Setup  | Set the machine to automatically send a pre-programmed cover page.  |
| Overseas Mode  | Set to On if you have difficulty sending faxes overseas.  |
| Set New Default  | Save your settings as the default.  |
| Factory Reset  | Restore all settings back to the factory settings.  |



You can save the current settings by pressing [Save as Shortcut].



### Related Information

- [Send a Fax](#)



## Receive a Fax

- [Receive Mode Settings](#)
- [Memory Receive Options](#)
- [Remote Fax Retrieval](#)

## Receive Mode Settings

- [Receive Modes Overview](#)
- [Choose the Correct Receive Mode](#)
- [Set the Number of Rings Before the Machine Answers \(Ring Delay\)](#)
- [Set the F/T Ring Time \(Fast Double-ring\)](#)
- [Set Fax Detect](#)
- [Shrink Page Size of an Oversized Incoming Fax](#)
- [Set the 2-sided Printing for Received Faxes](#)
- [Set the Fax Receive Stamp](#)
- [Receive a Fax at the End of a Telephone Conversation](#)

## Receive Modes Overview

Some receive modes answer automatically (Fax Only Mode and Fax/Tel Mode). You may want to change the Ring Delay before using these modes.

### Fax Only Mode

([Fax Only] in the machine's menu)

Fax Only Mode automatically answers every call as a fax.

### Fax/Tel Mode

([Fax/Tel] in the machine's menu)

Fax/Tel Mode helps you manage incoming calls, by recognising whether they are fax or voice calls and handling them in the following ways:

- Faxes will be received automatically.
- Voice calls will start the F/T ring to tell you to pick up the call. The F/T ring is a fast pseudo/double-ring made by your machine.

### Manual Mode

([Manual] in the machine's menu)

Manual Mode turns off all automatic answering operations unless you are using the BT Call Sign feature.

To receive a fax in Manual Mode, lift the handset of the external telephone connected to the machine.

When you hear fax tones (short repeating beeps), press the buttons in the table to receive a fax. Use the Fax Detect feature to receive faxes when you have lifted a handset on the same line as the machine.

| Applicable Models                                | To receive the fax  |
|--|---------------------|
| MFC-L9630CDN/MFC-L9635CDN/MFC-L9670CDN/MFC-EX670 | Fax Start > Receive |

### External TAD Mode

([External TAD] in the machine's menu)

External TAD Mode lets an external answering device manage your incoming calls.

Incoming calls will be handled in the following ways:

- Faxes will be received automatically.
- Voice callers can record a message on the external TAD.

## ✓ Related Information

- [Receive Mode Settings](#)

## Choose the Correct Receive Mode

You must choose a Receive Mode depending on the external devices and telephone services you have on your line.

By default, your machine will automatically receive any faxes that are sent to it. The diagram below will help you select the correct mode.

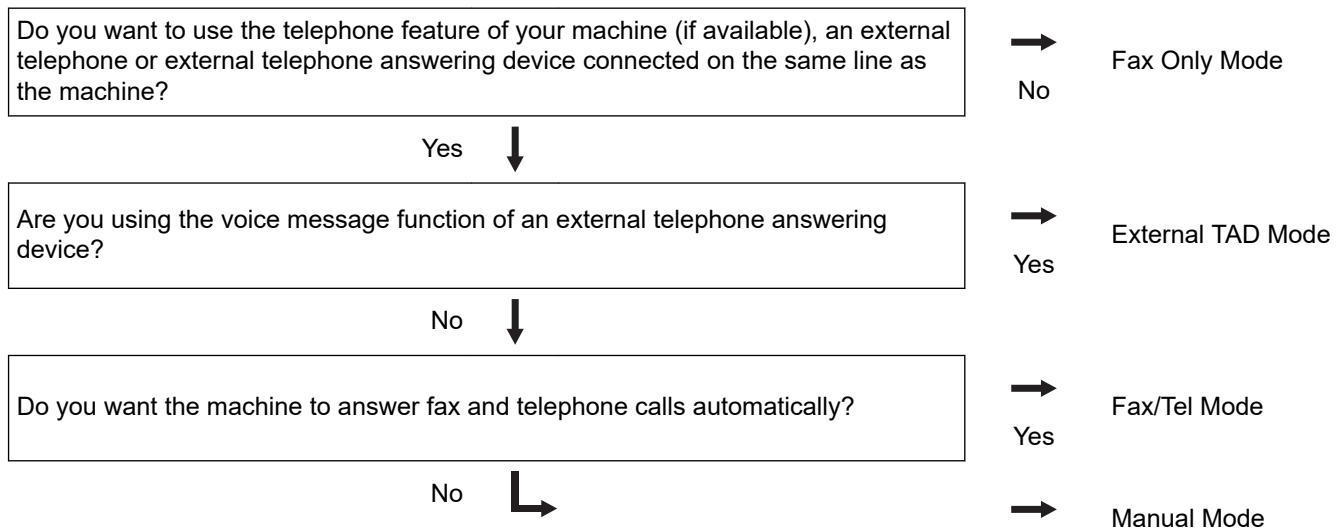

1. Press  [Settings] > [All Settings] > [Fax] > [Setup Receive] > [Receive Mode].



If your machine displays the [All Settings] menu on the Home screen, skip the [Settings] menu.



(U.K. only) If you cannot change the [Receive Mode], make sure the BT Call Sign feature is set to Off.

2. Press [Fax Only], [Fax/Tel], [External TAD], or [Manual].

3. Press .



### Related Information

- [Receive Mode Settings](#)

#### Related Topics:

- [Telephone and Fax Problems](#)

## Set the Number of Rings Before the Machine Answers (Ring Delay)

When somebody calls your machine, you will hear the normal telephone ring sound. The number of rings is set in the Ring Delay option.

- The Ring Delay setting sets the number of times the machine rings before it answers in the Fax Only and Fax/Tel Modes.
- If you have external or extension telephones on the same line as the machine, choose the maximum number of rings.

1. Press  [Settings] > [All Settings] > [Fax] > [Setup Receive] > [Ring Delay].



If your machine displays the [All Settings] menu on the Home screen, skip the [Settings] menu.

2. Press the number of rings you want.



If you select [0], the machine will answer immediately and the line will not ring at all (available only for some countries).

3. Press .



### Related Information

- [Receive Mode Settings](#)

#### Related Topics:

- [Telephone and Fax Problems](#)

## Set the F/T Ring Time (Fast Double-ring)

When you set the Receive Mode to Fax/Tel Mode, if the call is a fax, your machine will automatically receive it. However, if it is a voice call, the machine will sound the F/T ring (fast double-ring) for the time you set in the F/T Ring Time option. When you hear the F/T ring, it means that a voice caller is on the line.

The F/T Ring Time feature works when you set Fax/Tel Mode as the Receive Mode.

Because the F/T ring is made by the machine, extension and external telephones will not ring; however, you can still answer the call on any telephone.

1. Press  [Settings] > [All Settings] > [Fax] > [Setup Receive] > [F/T Ring Time].



If your machine displays the [All Settings] menu on the Home screen, skip the [Settings] menu.

2. Press how long you want the machine to ring to alert you that you have a voice call.
3. Press .



Even if the caller hangs up during the pseudo/double-ringing, the machine will continue to ring for the set time.



### Related Information

- [Receive Mode Settings](#)

## Set Fax Detect

**If Fax Detect is On:** The machine receives a fax call automatically, even if you answer the call. When you see [Receiving] on the LCD or when you hear “chirps” through the handset you are using, just replace the handset. Your machine will do the rest.

**If Fax Detect is Off:** If you are at the machine and answer a fax call by lifting the handset, press the buttons in the following table to receive the fax. If you answered at an extension or external telephone, press \*51.

| Applicable Models                                    | To receive the fax  |
|--|---|
| MFC-L9630CDN/MFC-L9635CDN/MFC-L9670CDN/<br>MFC-EX670 |  Fax > Fax Start > Receive |



- If this feature is set to [On], but your machine does not connect a fax call when you lift an extension or external telephone handset, press the remote activation code \*51.
- If you send faxes from a computer on the same telephone line and the machine intercepts them, set Fax Detect to [Off].

1. Press  [Settings] > [All Settings] > [Fax] > [Setup Receive] > [Fax Detect].



If your machine displays the [All Settings] menu on the Home screen, skip the [Settings] menu.

2. Press [On] or [Off].

3. Press .



### Related Information

- [Receive Mode Settings](#)

## Shrink Page Size of an Oversized Incoming Fax

If you enable the auto reduction function, the machine reduces each page of an incoming fax to fit on your paper. The machine calculates the reduction ratio by using the fax page size and your Paper Size setting.

1. Press  [Settings] > [All Settings] > [Fax] > [Setup Receive] > [Auto Reduction].



If your machine displays the [All Settings] menu on the Home screen, skip the [Settings] menu.

2. Press [On] or [Off].
3. Press .



### Related Information

- [Receive Mode Settings](#)



## Set the 2-sided Printing for Received Faxes

Your machine prints received faxes on both sides of the paper when [2-sided] is set to [On].

- Use A4, Letter, Legal, Folio (8.5 in. × 13 in.), Mexico Legal, or India Legal size paper (60 to 230 g/m<sup>2</sup>) for this function. Make sure the 2-sided tray is set to the correct paper size. If it is not, the paper may not be fed correctly, resulting in a skewed printout or a paper jam.
- When 2-sided printing is enabled, incoming faxes are automatically reduced to fit the paper in the paper tray.

1. Press  [Settings] > [All Settings] > [Fax] > [Setup Receive] > [2-sided].



If your machine displays the [All Settings] menu on the Home screen, skip the [Settings] menu.

2. Press [On] or [Off].

3. Press .



### Related Information

- [Receive Mode Settings](#)

## Set the Fax Receive Stamp

You can set the machine to print the received date and time at the top centre of each received fax page.

- Make sure you have set the current date and time on the machine.
- The received time and date will not appear when using Internet Fax.

1. Press  [Settings] > [All Settings] > [Fax] > [Setup Receive] > [Fax Rx Stamp].



If your machine displays the [All Settings] menu on the Home screen, skip the [Settings] menu.

2. Press [On] or [Off].

3. Press .



### Related Information

- [Receive Mode Settings](#)

## Receive a Fax at the End of a Telephone Conversation

If you are speaking on the telephone connected to your machine and the other party is also speaking on a telephone connected to his fax machine, at the end of the conversation, the other party can send you a fax before you both hang up.

Your machine's ADF must be empty.

1. Ask the other party to place the document in their machine and to press the Start or Send key.
2. When you hear the CNG tones (slowly repeating beeps), press [Fax Start].



If the machine is in Automatic Redial, wait until it is finished and try again.

3. Press [Receive] to receive a fax.
4. Replace the external handset.



### Related Information

- [Receive Mode Settings](#)

## Memory Receive Options

Use the Memory Receive options to direct incoming faxes while you are away from the machine. You can use only one Memory Receive option at a time.

Memory Receive can be set to:

- Fax Forwarding
- Fax Storage
- PC-Fax Receive
- Forward to Cloud

The machine forwards your received faxes to online services.

- Off
  - [Forward Incoming Faxes to Another Machine](#)
  - [Store Incoming Faxes in the Machine's Memory](#)
  - [Change Memory Receive Options](#)
  - [Turn Off Memory Receive](#)
  - [Print a Fax Stored in the Machine's Memory](#)
  - [Use PC-Fax Receive to Transfer Received Faxes to Your Computer \(Windows only\)](#)

## Forward Incoming Faxes to Another Machine

Use the Fax Forwarding feature to automatically forward your incoming faxes to another machine.

1. Press  [Settings] > [All Settings] > [Fax] > [Setup Receive] > [Memory Receive].



If your machine displays the [All Settings] menu on the Home screen, skip the [Settings] menu.

2. Press [Fax Forward].
3. Do one of the following:
  - Press [Manual] to enter the forwarding fax number (up to 20 digits) or email address using the LCD.  
Press [OK].



To forward a fax using an email address, press , enter the email address, and press [OK].

Select the file type you want.

(On certain models, you must download Internet Fax to use the Internet Fax feature and the Scan to Email server feature.)

- Press [Address Book].  
Swipe up or down or press ▲ or ▼ to scroll until you find the fax number or email address where you want your faxes to be forwarded.  
Press the fax number or email address you want.



Press [Backup Print: On] or [Backup Print: Off]. If you select [Backup Print: On], the machine also prints a copy of received faxes at your machine.

4. Press .



### Related Information

- [Memory Receive Options](#)

## Store Incoming Faxes in the Machine's Memory

Use the Fax Storage feature to store incoming faxes in the machine's memory. Retrieve your stored fax messages from your fax machine when you are at another location using the Remote Retrieval commands. Your machine will print a backup copy of each stored fax.

1. Press  [Settings] > [All Settings] > [Fax] > [Setup Receive] > [Memory Receive].



If your machine displays the [All Settings] menu on the Home screen, skip the [Settings] menu.

2. Press [Fax Storage].



Press [Backup Print: On] or [Backup Print: Off]. If you select [Backup Print: On], the machine also prints a copy of received faxes at your machine.

3. Press .



### Related Information

- [Memory Receive Options](#)

## Change Memory Receive Options

If received faxes are in your machine's memory when you change the Remote Fax operations, the LCD will ask you one of the following questions:

**If received faxes have been printed automatically, the LCD displays [Erase all documents?]**

- Do one of the following:
  - If you press [Yes], faxes in the memory will be erased before the setting changes.
  - If you press [No], faxes in the memory will not be erased and the setting will be unchanged.

**If unprinted faxes are in the machine's memory, the LCD displays [Print all faxes?]**

- Do one of the following:
  - If you press [Yes], faxes in the memory will be printed before the setting changes.
  - If you press [No], faxes in the memory will not be printed and the setting will be unchanged.

**If received faxes are left in the machine's memory when you change to [PC Fax Receive] from another option ([Fax Forward] or [Fax Storage]).**

- Press [<USB>] or the name of the computer if you are on a network, and then press [OK]. You will be asked if you want to turn on Backup Print.

The LCD displays:

[Send Fax to PC?]

- If you press [Yes], faxes in the memory will be sent to your computer before the setting changes.
- If you press [No], faxes in the memory will not be erased and the setting will be unchanged.



### Related Information

- [Memory Receive Options](#)

## Turn Off Memory Receive

Turn off Memory Receive if you do not want the machine to save or transfer incoming faxes.

1. Press  [Settings] > [All Settings] > [Fax] > [Setup Receive] > [Memory Receive].



If your machine displays the [All Settings] menu on the Home screen, skip the [Settings] menu.

2. Press [Off].



The LCD displays options if there are received faxes still in your machine's memory.

3. Press .



### Related Information

- [Memory Receive Options](#)



## Print a Fax Stored in the Machine's Memory

If you select [Fax Storage], you can still print a fax from the memory when you are at your machine.

1. Press  [Settings] > [All Settings] > [Fax] > [Print Document].



If your machine displays the [All Settings] menu on the Home screen, skip the [Settings] menu.

2. Press [Yes].



### Related Information

- [Memory Receive Options](#)

#### Related Topics:

- [Error and Maintenance Messages](#)

## Use PC-Fax Receive to Transfer Received Faxes to Your Computer (Windows only)

Turn on the PC-Fax Receive feature to automatically store incoming faxes to your machine's memory, and then send them to your computer. Use your computer to view and store these faxes.

To transfer the received faxes to your computer you must have the PC-FAX Receiving software running on your computer.

Even if you have turned off your computer (at night or on the weekend, for example), your machine will receive and store your faxes in its memory.

When you start your computer and the PC-FAX Receiving software runs, your machine transfers your faxes to your computer automatically.

If you selected [Backup Print: On], the machine will also print the fax.

1. Press  [Settings] > [All Settings] > [Fax] > [Setup Receive] > [PC Fax Receive].



If your machine displays the [All Settings] menu on the Home screen, skip the [Settings] menu.

2. Press [On].
3. Press [OK], and then follow the instructions on the LCD.



- PC-Fax Receive is not available for macOS.
- If you get an error message and the machine cannot print the faxes in the memory, you can use this setting to transfer your faxes to your computer.

4. Press [<USB>] or the name of the computer you want to receive faxes if you are on a network, and then press [OK].
5. Press [Backup Print: On] or [Backup Print: Off].
6. Press .



### Related Information

- [Memory Receive Options](#)

## Remote Fax Retrieval

Use Remote Retrieval to call your machine from any touch-tone telephone or fax machine, and use a remote access code and remote commands to retrieve fax messages.

- [Set a Remote Access Code](#)
- [Use Your Remote Access Code](#)
- [Remote Retrieval Commands](#)
- [Forward Faxes Remotely](#)
- [Change the Fax Forwarding Number](#)

## Set a Remote Access Code

Set a Remote Access Code to access and control your machine even when you are away from it.

Before you can use the remote access and retrieval features, you must set up your own code. The factory default code is the inactive code (---\*).

1. Press  [Settings] > [All Settings] > [Fax] > [Remote Access].



If your machine displays the [All Settings] menu on the Home screen, skip the [Settings] menu.

2. Enter a three-digit code using the numbers [0] to [9], [\*] or [#] using the LCD (the preset "\*" cannot be changed), and then press [OK].



- DO NOT use the same code used for your Remote Activation Code (\*51) or Remote Deactivation Code (#51).
- To make your code inactive, press and hold  to restore the inactive setting (---\*), and then press [OK].

3. Press .



### Related Information

- [Remote Fax Retrieval](#)

## Use Your Remote Access Code

1. Dial your fax number from a telephone or another fax machine using touch tone.
2. When your machine answers, immediately enter your Remote Access Code (three digits followed by \*).
3. The machine signals if it has received messages:
  - One long beep -- Fax messages
  - No beeps -- No messages
4. When the machine gives two short beeps, enter a command.
  - The machine will hang up if you wait longer than 30 seconds to enter a command.
  - The machine will beep three times if you enter an invalid command.
5. Press 9 0 to reset the machine when you are finished.
6. Hang up.

This function may not be available in some countries or supported by your local telephone company.



### Related Information

- [Remote Fax Retrieval](#)

## Remote Retrieval Commands

Use the Remote Commands in this table to access fax commands and options when you are away from your machine. When you call the machine and enter your remote access code (three digits followed by \*), the system will sound two short beeps and you must enter a Remote Command (column 1), followed by one of the options (column 2) for that command.

| Remote command | Option  | Description   |
|----------------|---|---|
| 95             | <b>Change the Fax Forwarding, or Fax Storage settings</b> |   |
|                | 1 OFF   | You can select <i>Off</i> after you retrieve or erase all your messages.  |
|                | 2 Fax Forwarding  | One long beep means the change is accepted. If you hear three short beeps, you cannot make a change because one of the settings may not be configured correctly (for example, a Fax Forwarding number has not been registered). You can register your Fax Forwarding number by entering 4. After you register the number, Fax Forwarding will work. |
|                | 4 Fax Forwarding number                                   |   |
|                | 6 Fax Storage   |   |
| 96             | <b>Retrieve a fax</b>                                     |   |
|                | 2 Retrieve all faxes                                      | Enter the fax number of a remote fax machine to receive stored fax messages.  |
|                | 3 Erase faxes from memory                                 | If you hear one long beep, fax messages have been erased from memory.   |
| 97             | <b>Check the receiving status</b>                         |   |
|                | 1 Fax   | Check whether your machine has received any faxes. If yes, you will hear one long beep. If not, you will hear three short beeps.  |
| 98             | <b>Change the Receive Mode</b>                            |   |
|                | 1 External TAD  | One long beep means the change has been accepted.   |
|                | 2 Fax/Tel   |   |
|                | 3 Fax Only  |   |
| 90             | <b>Exit</b>   | Press <b>9 0</b> to stop remote retrieval. Wait for the long beep, then hang up.  |



### Related Information

- [Remote Fax Retrieval](#)

## Forward Faxes Remotely

Call your machine from any touch-tone telephone or fax machine to forward incoming faxes to another machine.

You must turn Fax Storage on to use this feature.

1. Dial your fax number.
2. When your machine answers, enter your Remote Access Code (three digits followed by \*). If you hear one long beep, you have messages.
3. When you hear two short beeps, press 9 6 2.
4. Wait for the long beep, and then use the dial pad to enter the number of the remote fax machine where you want your fax messages sent, followed by ## (up to 20 digits).



You cannot use \* and # as dial numbers. However, press # if you want to create a pause.

5. Hang up after you hear your machine beep. Your machine will call the other fax machine, which will then print your fax messages.



### Related Information

- [Remote Fax Retrieval](#)

## Change the Fax Forwarding Number

You can change your fax forwarding number from another touch-tone telephone or fax machine.

1. Dial your fax number.
2. When your machine answers, enter your Remote Access Code (three digits followed by \*). If you hear one long beep, you have messages.
3. When you hear two short beeps, press 9 5 4.
4. Wait for the long beep, enter the new number (up to 20 digits) of the remote fax machine you want your fax messages forwarded to using the dial pad, then enter # #.

You will hear one long beep.



You cannot use \* and # as dial numbers. However, press # if you want to create a pause.

5. When you hear two short beeps, press 9 0 to stop Remote Access when you have finished.
6. Hang up after you hear your machine beep.



### Related Information

- [Remote Fax Retrieval](#)



## Voice Operations and Fax Numbers

- [Voice Operations](#)
- [Store Fax Numbers](#)
- [Set up Broadcasting Groups](#)
- [Combine Address Book Numbers](#)

## Voice Operations

- [Pick up a Voice Call in Fax/Tel Receive Mode](#)

## Pick up a Voice Call in Fax/Tel Receive Mode

When the machine is in Fax/Tel mode, it will use the F/T Ring (fast double-ring) to alert you to pick up a voice call.

If you are at the machine, lift the external telephone's handset, and then press the button in the following table to answer:

| Applicable Models                                    | To pick up voice call |
|--|-----------------------|
| MFC-L9630CDN/MFC-L9635CDN/MFC-L9670CDN/<br>MFC-EX670 | Pickup                |

If you are at an extension telephone, lift the handset during the F/T Ring, and then press #51 between the fast double-rings. If no one is on the line, or if someone wants to send you a fax, send the call back to the machine by pressing \*51.



### Related Information

- [Voice Operations](#)



## Store Fax Numbers

- [Store Address Book Numbers](#)
- [Change or Delete Address Book Names or Numbers](#)

## Store Address Book Numbers

1. Press  [Fax] > [Address Book].
2. Do the following steps:
  - a. Press [Edit].
  - b. Press [Add New Address].
  - c. Press [Name].
  - d. Enter the name using the LCD (up to 16 characters), and then press [OK].
  - e. Press [Address].
  - f. Enter the fax or telephone number using the LCD (up to 20 digits), and then press [OK].



To store an email address to use with Internet Fax or Scan to Email server, press   and enter the email address and press [OK].

(On certain models, you must download Internet Fax to use the Internet Fax feature and the Scan to Email server feature.)

- g. Press [OK].
- To store another Address Book number, repeat these steps.
3. Press .



### Related Information

- [Store Fax Numbers](#)
- [Save Outgoing Call Numbers to the Address Book](#)

## Save Outgoing Call Numbers to the Address Book

You can copy numbers from your Outgoing Call history and save them in your Address Book.

1. Press  [Fax] > [Call History] > [Outgoing Call].
2. Swipe up or down or press ▲ or ▼ to display the number you want, and then press it.
3. Press [Edit] > [Add to Address Book] > [Name].



To delete the number, press [Edit] > [Delete]. Press [Yes] to confirm.

4. Enter the name using the LCD (up to 16 characters).
5. Press [OK].
6. Press [OK] to confirm the fax or telephone number you want to store.
7. Press .



### Related Information

- [Store Address Book Numbers](#)

## Change or Delete Address Book Names or Numbers

1. Press  [Fax] > [Address Book] > [Edit].
2. Do one of the following:  
Press [Change] to edit the names of fax or telephone numbers.  
Swipe up or down or press ▲ or ▼ to display the number you want to change, and then press it.
  - To change the name, press [Name]. Enter the new name (up to 16 characters) using the LCD, and then press [OK].
  - To change the fax or telephone number, press [Address]. Enter the new fax or telephone number (up to 20 digits) using the LCD, and then press [OK].Press [OK] to finish.



### How to enter text:

To change a character, press ◀ or ▶ to position the cursor to highlight the incorrect character, and then press .

Enter the new character.

To delete numbers, press [Delete].

Select the fax or telephone numbers you want to delete by pressing them to display a check mark, and then press [OK].

3. Press .



### Related Information



- [Store Fax Numbers](#)

## Set up Broadcasting Groups

A Group, which can be stored in the Address Book allows you to send the same fax message to many fax numbers.

First, you must store each fax number in the Address Book. Then you can include them as numbers in the Group. Each Group uses up an Address Book number.

| Applicable Models                                    | Maximum number of groups | Maximum numbers in a group |
|--|--------------------------|----------------------------|
| MFC-L9630CDN/MFC-L9635CDN/<br>MFC-L9670CDN/MFC-EX670 | 20                       | 299                        |

1. Press  [Fax] > [Address Book].
2. Do the following steps:
  - a. Press [Edit] > [Setup Groups] > [Name].
  - b. Enter the Group name (up to 16 characters) using the LCD, and then press [OK].
  - c. Press [Add/Delete].
  - d. Add Address Book numbers to the Group by pressing them to display a checkmark, and then press [OK].
  - e. Read and confirm the displayed list of names and numbers you have chosen, and then press [OK] to save your Group.To store another Group for broadcasting, repeat these steps.
3. Press .

### Related Information

- [Voice Operations and Fax Numbers](#)
  - [Change a Broadcasting Group Name](#)
  - [Delete a Broadcasting Group](#)
  - [Add or Delete a Broadcasting Group Member](#)



## Change a Broadcasting Group Name

1. Press  [Fax] > [Address Book] > [Edit] > [Change].
2. Swipe up or down or press ▲ or ▼ to display the Group you want, and then press the Group name.
3. Press [Name].
4. Enter the new Group name (up to 16 characters) using the LCD, and then press [OK].



How to change the stored name:

To change a character, press ◀ or ▶ to position the cursor to highlight the incorrect character, and then press .

Enter the new character.



5. Press [OK].
6. Press .



### Related Information

- [Set up Broadcasting Groups](#)

## Delete a Broadcasting Group



1. Press  [Fax] > [Address Book] > [Edit] > [Delete].
2. Swipe up or down or press ▲ or ▼ to display the Group you want, and then press the Group name.
3. Press [OK].
4. Press .



### Related Information

- [Set up Broadcasting Groups](#)

## Add or Delete a Broadcasting Group Member

1. Press  [Fax] > [Address Book] > [Edit] > [Change].
2. Swipe up or down or press ▲ or ▼ to display the Group you want, and then press the Group name.
3. Swipe up or down or press ▲ or ▼ to display the [Add/Delete] option, and then press [Add/Delete].
4. Swipe up or down or press ▲ or ▼ to display the number you want to add or delete.
5. Do the following for each number you want to change:
  - To add a number to the Group, press the checkbox of the number to add a check mark.
  - To delete a number from the Group, press the checkbox of the number to remove the check mark.
6. Press [OK].
7. Press [OK].
8. Press .



### Related Information

- [Set up Broadcasting Groups](#)

## Combine Address Book Numbers

Sometimes you may want to choose from several long-distance carriers when you send a fax. Rates may vary depending on the time and destination. To take advantage of low rates, you can store the access codes of long-distance carriers and credit card numbers as Address Book numbers.

You can store these long dialling sequences by dividing them and setting them up as separate Address Book numbers in any combination. You can even include manual dialling using the dial pad.

For example: You might have stored '01632' and '960555' in your machine as shown in the following table.

| Applicable Models                                    | '01632' stored in       | '960555' stored in      |
|--|-------------------------|-------------------------|
| MFC-L9630CDN/MFC-L9635CDN/<br>MFC-L9670CDN/MFC-EX670 | Address Book: Brother 1 | Address Book: Brother 2 |

You can use them both to dial '01632-960555' by using the following procedure.

1. Press  [Fax] > [Address Book].
2. Swipe up or down or press ▲ or ▼ to display the number of Brother 1.
3. Press the number.
4. Press [Apply].
5. Press [Address Book].
6. Press [OK].
7. Swipe up or down or press ▲ or ▼ to display the number of Brother 2.
8. Press the number.
9. Press [Apply].
10. Press [Fax Start].

The machine will dial '01632-960555'.

To temporarily change a number, you can substitute part of the number by pressing it using the LCD. For example, to change the number to '01632-960556', you could enter the number (Brother 1: 01632) using the Address Book, press [Apply], and then enter 960556 using the LCD.



If you must wait for another dial tone or signal at any point in the dialling sequence, create a pause in the number by pressing [Pause].



### Related Information

- [Voice Operations and Fax Numbers](#)

## Telephone Services and External Devices

- [Use BT Call Sign](#)
- [Set the Telephone Line Type](#)
- [External TAD \(Telephone Answering Device\)](#)
- [External and Extension Telephones](#)
- [Multi-line Connections \(PBX\)](#)

## Use BT Call Sign

This feature lets you use the BT Call Sign subscriber service which allows you to have at least two separate telephone numbers on one telephone line. Each telephone number has its own distinctive ringing pattern, so you know which telephone number is ringing. This is one way you can have a separate telephone number for your machine.

Your machine has a BT Call Sign compatible distinctive ringing function, allowing you to dedicate a second telephone number (on the same telephone line) just for receiving faxes.



- This feature is available only in the U.K.
- You can switch BT Call Sign Off temporarily, then turn it back on. When you get a new fax number, make sure you reset this function. This machine will automatically answer incoming calls that use your new fax number.
- When you set the BT Call Sign feature to On, the receive mode is set to [Manual] automatically. The [Manual] mode will not respond to incoming telephone calls, because the number you use for telephone calls will use the normal ring pattern.



### Related Information

- [Telephone Services and External Devices](#)
  - [Enable the Machine to Work with BT Call Sign](#)

## Enable the Machine to Work with BT Call Sign

- This feature is available only in the U.K.
- This feature will only work with your external phone.

1. Press  [Settings] > [All Settings] > [Fax] > [Miscellaneous] > [BT Call Sign].



If your machine displays the [All Settings] menu on the Home screen, skip the [Settings] menu.

2. Press [On] or [Off].

3. Press .

If you turn off BT Call Sign, the receive mode stays in Manual mode. You will need to set the receive mode again.





### Related Information

- [Use BT Call Sign](#)

## Set the Telephone Line Type

If you are connecting the machine to a line that features PBX or ISDN to send and receive faxes, you must select a Telephone Line Type that matches your line's features.

1. Press  [Settings] > [All Settings] > [Initial Setup] > [Phone Line Set].

 If your machine displays the [All Settings] menu on the Home screen, skip the [Settings] menu.

2. Press [Normal], [PBX], or [ISDN].
3. If you selected [PBX], do the following:
  - a. Press [On] or [Always].

- 
  - If you select [On], the machine dials a prefix number before the fax number only when [R] is pressed.
  - If you select [Always], the machine always dials a prefix number before the fax number.

- b. Press [Dial Prefix].
- c. Enter the prefix number using the LCD, and then press [OK].

 Use the numbers 0 to 9, #, \* and !. You cannot use ! with any other numbers or characters.

4. Press .

### Related Information

- [Telephone Services and External Devices](#)
  - [PBX and TRANSFER](#)



## PBX and TRANSFER

The machine's [Phone Line Set] default setting is [Normal], which lets the machine connect to a standard Public Switched Telephone Network (PSTN) line. However, many offices use a central telephone system or Private Branch Exchange (PBX). Your machine can be connected to most types of PBX. The machine's recall feature supports timed break recall only (TBR). TBR will work with most PBX systems allowing you to gain access to an outside line, or transfer calls to another extension. To use this feature, press the button in the table.

| Applicable Models                                | To use the machine's recall feature |
|--|-------------------------------------|
| MFC-L9630CDN/MFC-L9635CDN/MFC-L9670CDN/MFC-EX670 | R                                   |



Program a press of the button in the table as part of a number stored in the Address Book (One Touch Dial and Speed Dial in some models). When programming the Address Book number (One Touch Dial number and Speed Dial number in some models), press the button first (the LCD displays '!'), then enter the telephone number. This avoids having to press the button each time before you dial from the Address Book (One Touch Dial or Speed Dial). Your Telephone Line Type must be set to PBX on the machine to use this programming.



### Related Information

- [Set the Telephone Line Type](#)

## External TAD (Telephone Answering Device)

Connect an external Telephone Answering Device (TAD) to the same line as your machine. When the TAD answers a call, your machine will “listen” for the CNG (fax calling) tones sent by a sending fax machine. If it hears them it will take over the call and receive the fax. If it does not hear them, it will let your TAD take a voice message and the LCD will show [Telephone].

The external TAD must answer within four rings (we recommend setting it to two rings). This is because your machine cannot hear the CNG tones until the external TAD has picked up the call. The sending machine will send CNG tones for only eight to ten seconds longer. We do not recommend using the toll saver feature on your external TAD if it needs more than four rings to activate it.

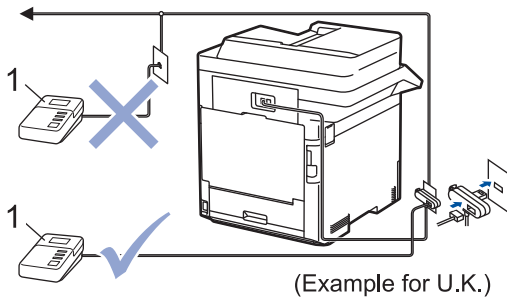

1 TAD

### IMPORTANT

DO NOT connect a TAD elsewhere on the same telephone line.



If you have problems receiving faxes, reduce the Ring Delay setting on your external TAD.



### Related Information

- [Telephone Services and External Devices](#)
  - [Connect an External TAD](#)
  - [Record an Outgoing Message \(OGM\) on the External TAD](#)

## Connect an External TAD

1. Set your external TAD to the minimum number of rings allowed. For more information, contact your telephone provider. (The machine's Ring Delay setting does not apply.)
2. Record an outgoing message on your external TAD.
3. Set the TAD to answer calls.
4. Set the Receive Mode on your machine to [External TAD].



### Related Information

- [External TAD \(Telephone Answering Device\)](#)
-

## Record an Outgoing Message (OGM) on the External TAD

1. Record five seconds of silence at the beginning of your message. This allows your machine time to listen for fax tones.
2. Limit your speaking to 20 seconds.
3. End your 20-second message by giving your Remote Activation Code for those who may need to send faxes manually. For example: "After the beep, leave a message or press \*51 and start to send a fax."

### NOTE

We recommend beginning your OGM with an initial five-second silence because the machine cannot hear fax tones over a loud voice. You may try leaving out this pause, but if your machine has trouble receiving faxes, then you should re-record the OGM to include it.



### Related Information

- [External TAD \(Telephone Answering Device\)](#)

## External and Extension Telephones

- [Connect an External or Extension Telephone](#)
- [Operation from External and Extension Telephones](#)
- [Use Extension Telephones](#)
- [If You Use a Non-Brother Cordless External Handset](#)
- [Use the Remote Codes](#)

## Connect an External or Extension Telephone

You can connect a separate telephone to your machine as shown in the diagram below.

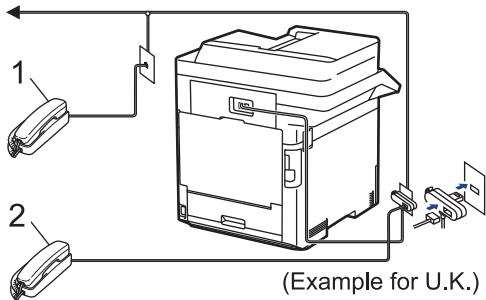

- 1 Extension telephone
- 2 External telephone



Make sure you use an external telephone with a cable no more than three metres long.



### Related Information

- [External and Extension Telephones](#)

## Operation from External and Extension Telephones

If you answer a fax call at an extension or an external telephone, you can make your machine take the call by using the Remote Activation Code. When you press the Remote Activation Code **\*51**, the machine starts to receive the fax.

If the machine answers a voice call and pseudo/double-rings for you to take over, you can take the call at an extension telephone by pressing the Remote Deactivation Code **#51**.

### If you answer a call and no one is on the line:

You are receiving a manual fax.

Press **\*51** and wait for the chirp or until the LCD displays [Receiving], and then hang up.



You can also use the Fax Detect feature to make your machine automatically take the call.



### Related Information

- [External and Extension Telephones](#)

## Use Extension Telephones

Your premises may already be wired with parallel extension telephones, or you may plan to add extension telephones to your line, as well as your machine. While the simplest arrangement is a straightforward parallel connection, there are some problems with this. The most obvious is inadvertent interruption of a fax transmission caused by someone picking up an extension telephone to make an outgoing call. Also, the remote activation code feature may not operate reliably in such a simple configuration.

This machine may also be set to make a delayed transmission (a transmission at a preset time). This preset job may coincide with someone picking up an extension handset.

These problems can be eliminated, if you arrange modification of your extension wiring circuit, such that extension devices are connected “downstream” of your machine in a master/slave configuration (see Figure 2). In this configuration the machine can always detect whether a telephone is in use. Thus it will not attempt to use the line during that time. This is known as “telephone off-hook detection.”

The inadvisable configuration is shown in figure 1, and the recommended master/slave configuration is shown in figure 2.

This new connection configuration can be arranged by contacting BT, Kingston upon Hull Telecommunications, your PBX maintainer, or a qualified telephone installation company. The extension telephone circuit should be terminated on a normal modular plug (BT 431A style), which in turn should be put into the modular socket of the white “T”-shaped connector provided as part of the line cord assembly.

### Inadvisable connection of extension sockets (Figure 1.)

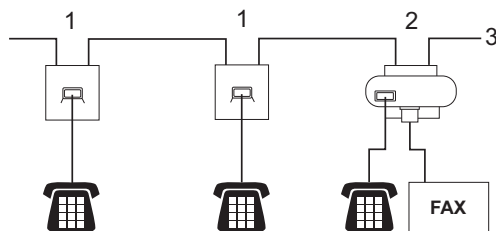

1. Extension socket
2. Master socket
3. Incoming line

### Recommended connection of extension sockets (Figure 2.)

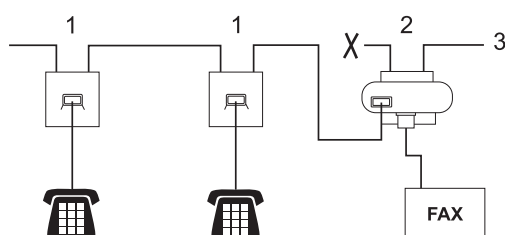

1. Extension socket
2. Master socket
3. Incoming line

The fax machine must be plugged into the master socket.



These telephones are now connected as external devices, because they are connected to the machine via the T-connector.

## ✓ Related Information

- [External and Extension Telephones](#)



## If You Use a Non-Brother Cordless External Handset

If your non-Brother cordless telephone is connected to the telephone line cord and you typically carry the cordless handset elsewhere, it is easier to answer calls during the Ring Delay.

If you let the machine answer first, you must go to the machine so you can press [Pickup] or **Tel/R** to transfer the call to the cordless handset.



### Related Information

- [External and Extension Telephones](#)

## Use the Remote Codes

### Remote Activation Code

If you answer a fax call on an extension or external telephone, you can tell your machine to receive it by pressing the Remote Activation Code **\*51**. Wait for the chirping sounds, and then replace the handset.

If you answer a fax call at the external telephone, you can make the machine receive the fax by pressing the buttons in the following table:

| Applicable Models                                | To make the machine receive the fax |
|--|-------------------------------------|
| MFC-L9630CDN/MFC-L9635CDN/MFC-L9670CDN/MFC-EX670 | Fax Start and then Receive          |

### Remote Deactivation Code

If you receive a voice call and the machine is in F/T mode, it will start to sound the F/T ring (fast double-ring) after the initial ring delay. If you pick up the call on an extension telephone you can turn the F/T ring off by pressing **#51** (make sure you press this between the rings).

If the machine answers a voice call and fast double-rings for you to take over, you can take the call at the external telephone by pressing the button in the following table:

| Applicable Models                                | To pick up voice call |
|--|-----------------------|
| MFC-L9630CDN/MFC-L9635CDN/MFC-L9670CDN/MFC-EX670 | Pickup                |



### Related Information

- [External and Extension Telephones](#)
  - [Change the Remote Codes](#)

## Change the Remote Codes

The preset Remote Activation Code is **\*51**. The preset Remote Deactivation Code is **#51**. If you are always disconnected when accessing your External TAD remotely, try changing the three-digit remote codes using the numbers 0-9, \*, #.

1. Press  [Settings] > [All Settings] > [Fax] > [Setup Receive] > [Remote Codes].



If your machine displays the [All Settings] menu on the Home screen, skip the [Settings] menu.

2. Do one of the following:
  - To change the Remote Activation Code, press [Act. Code]. Enter the new code, and then press [OK].
  - To change the Remote Deactivation Code, press [Deact. Code]. Enter the new code, and then press [OK].
  - If you do not want to change the Codes, go to the next step.
  - To turn off (or turn on) the Remote Codes, press [Remote Codes], and then press [Off] (or [On]).
3. Press .



### Related Information

- [Use the Remote Codes](#)

## Multi-line Connections (PBX)

We suggest you ask the company that installed your PBX to connect your machine. If you have a multi-line system we suggest you ask the installer to connect the unit to the last line on the system. This prevents the machine being activated each time the system receives telephone calls. If all incoming calls will be answered by a switchboard operator, we recommend setting the Receive Mode to [Manual].

We cannot guarantee that your machine will operate correctly under all circumstances when connected to a PBX. Any difficulties with sending or receiving faxes should be reported first to the company that handles your PBX.



### Related Information

- [Telephone Services and External Devices](#)
-

## Fax Reports

- [Print a Transmission Verification Report](#)
- [Print a Fax Journal](#)

## Print a Transmission Verification Report

You can use the Transmission Verification Report as proof that you sent a fax. This report lists the receiving party's name or fax number, the time and date of transmission, duration of transmission, number of pages sent, and whether or not the transmission was successful.

There are several settings available for the Transmission Verification Report:

|                     |  |
|---------------------|--|
| On                  | Prints a report after every fax you send.  |
| On (+Image)         | Prints a report after every fax you send.<br>A portion of the fax's first page appears on the report.                                |
| Error only          | Prints a report if your fax is unsuccessful due to a transmission error.   |
| Error only (+Image) | Prints a report if your fax is unsuccessful due to a transmission error.<br>A portion of the fax's first page appears on the report. |
| Off                 | Your machine does not print any reports after sending faxes.   |

1. Press  [Settings] > [All Settings] > [Fax] > [Report Setting] > [XMIT Report].



If your machine displays the [All Settings] menu on the Home screen, skip the [Settings] menu.

2. Press the option you want.

If you select [On (+Image)] or [Error only (+Image)], the image will not appear on the Transmission Verification Report if Real Time Transmission is set to [On].

3. Press .

If the transmission is successful, OK appears next to RESULT on the Transmission Verification Report. If the transmission is not successful, NG appears next to RESULT.



### Related Information

- [Fax Reports](#)

## Print a Fax Journal

You can set the machine to print a Fax Journal at specific intervals (every 50 faxes, 6, 12 or 24 hours, 2 or 7 days).

1. Press  [Settings] > [All Settings] > [Fax] > [Report Setting] > [Journal Period] > [Journal Period].



If your machine displays the [All Settings] menu on the Home screen, skip the [Settings] menu.

2. Swipe up or down or press ▲ or ▼ to select the interval you want, and then press it.
  - Every 6, 12, 24 hours, 2 or 7 days  
The machine will print the report at the selected time and then erase all reception and transmission log data from its memory. If the machine's memory becomes full with 200 log data before the time you selected has passed, the machine will print the Journal early and then erase all jobs from the memory. If you want an extra report before it is due to print, you can print it without erasing the log data from the memory.
  - Every 50 Faxes  
The machine will print the Journal when the machine has stored 50 reception and transmission log data.
3. If you selected every 6, 12, 24 hours, 2 or 7 days, do one of the following to enter the time to start printing:
  - If you set [12h Clock] as the format in the [Clock Type] setting, press [Time]. Enter the time (in 12-hour format) using the LCD, and then press [AM] or [PM].  
Press [OK].
  - If you set [24h Clock] in the [Clock Type] setting, press [Time], and then enter the time (in 24-hour format) using the LCD.  
Press [OK].  
(For example: enter 19:45 for 7:45 PM.)
4. If you selected [Every 7 Days], press [Day].
5. Swipe up or down or press ▲ or ▼ to display the [Every Monday], [Every Tuesday], [Every Wednesday], [Every Thursday], [Every Friday], [Every Saturday] or [Every Sunday] option, and then press the first day of the 7-day countdown.
6. Press .



### Related Information

- [Fax Reports](#)

## PC-FAX

- [PC-FAX for Windows](#)
- [PC-FAX for Mac](#)



## PC-FAX for Windows

- [PC-FAX Overview \(Windows\)](#)
- [Send a Fax Using PC-FAX \(Windows\)](#)
- [Receive Faxes on Your Computer \(Windows\)](#)

## PC-FAX Overview (Windows)

Reduce paper consumption and save time by using the Brother PC-FAX software to send faxes directly from your computer.

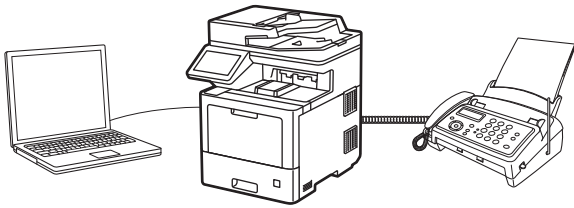

- [Configure PC-FAX \(Windows\)](#)
- [Configure your PC-Fax Address Book \(Windows\)](#)

## Configure PC-FAX (Windows)

Before sending faxes using PC-FAX, personalise the send options in each tab of the **PC-FAX Setup** dialog box.

1. Launch  (**Brother Utilities**), and then click the drop-down list and select your model name (if not already selected).
2. Click **PC-FAX** in the left navigation bar, and then click **Setup Sending**.

The **PC-FAX Setup** dialog box appears.

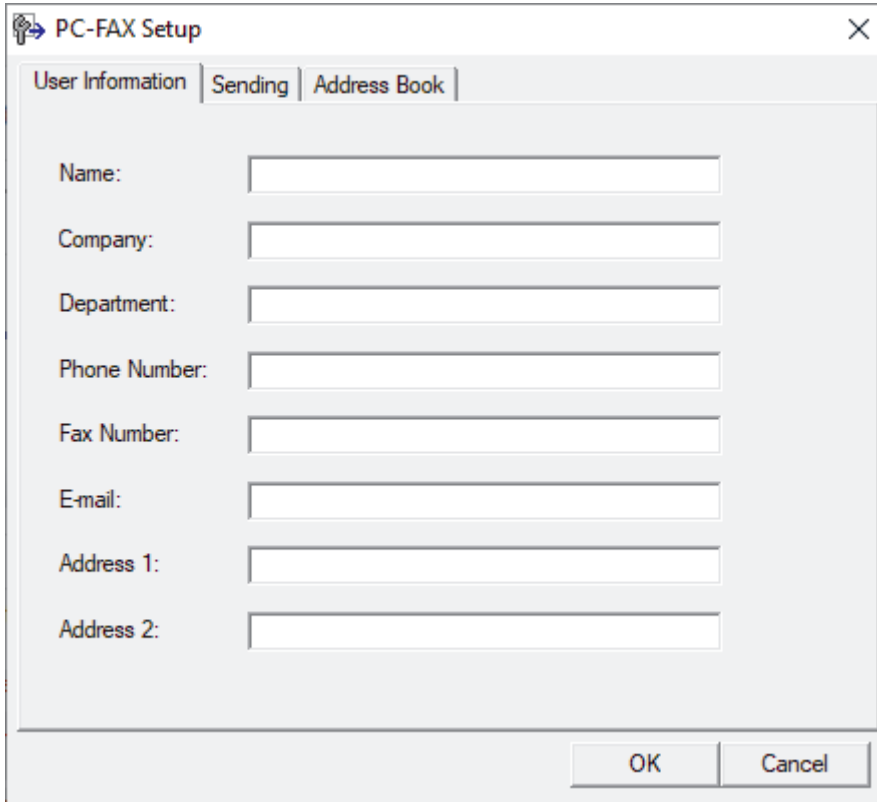

3. Do one of the following:
  - Click the **User Information** tab, and then type your user information in the fields.



Each Microsoft account can have its own customised **User Information** screen for custom fax headers and cover pages.

- Click the **Sending** tab, and then type the number needed to access an outside line (if needed) in the **Outside line access** field. Select the **Include header** checkbox to include the header information.
- Click the **Address Book** tab, and then select the address book you want to use for PC-FAX from the **Select Address Book** drop-down list.

4. Click **OK**.



### Related Information

- [PC-FAX Overview \(Windows\)](#)

## Configure your PC-Fax Address Book (Windows)

Add, edit, and delete members and groups to personalise your **Address Book**.

- [Add a Member to your PC-FAX Address Book \(Windows\)](#)
- [Create a Group in your PC-FAX Address Book \(Windows\)](#)
- [Edit Member or Group Information in your PC-FAX Address Book \(Windows\)](#)
- [Delete a Member or Group in your PC-FAX Address Book \(Windows\)](#)
- [Export your PC-FAX Address Book \(Windows\)](#)
- [Import Information to your PC-FAX Address Book \(Windows\)](#)

## Add a Member to your PC-FAX Address Book (Windows)

Add new people and their fax information to the PC-Fax Address Book if you want to send a fax using the Brother PC-Fax software.

1. Launch  (**Brother Utilities**), and then click the drop-down list and select your model name (if not already selected).
2. Click **PC-FAX** in the left navigation bar, and then click **Address Book (Send)**.

The **Address Book** dialog box appears.

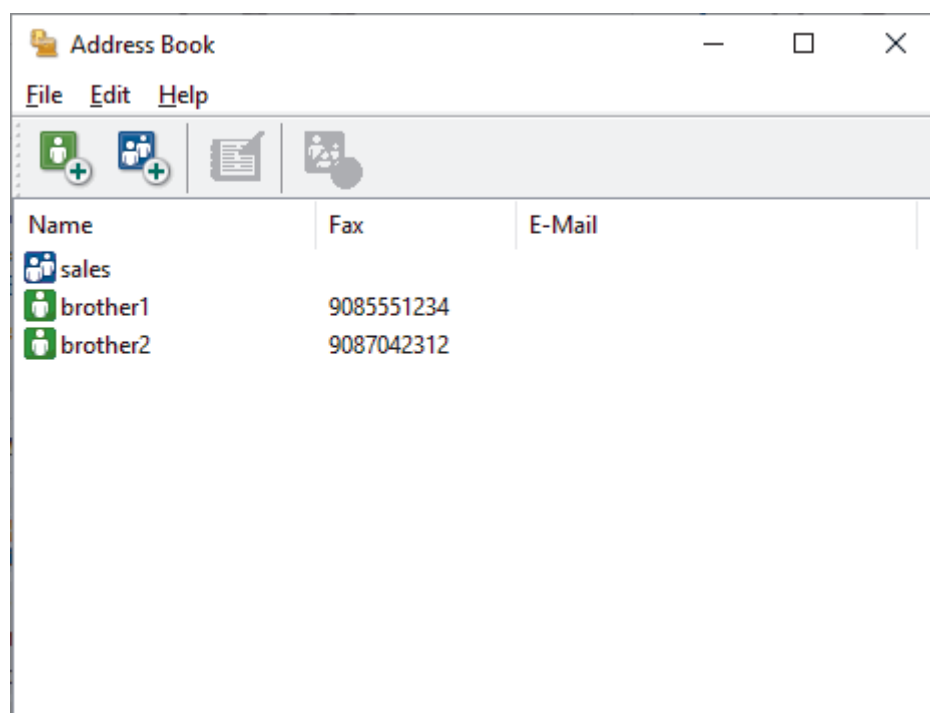

3. Click .

The **Address Book Member Setup** dialog box appears.

4. Type the member's information in the corresponding fields. Only the **Name** field is required.
5. Click **OK**.

### Related Information

- [Configure your PC-Fax Address Book \(Windows\)](#)

## Create a Group in your PC-FAX Address Book (Windows)

Create a group to broadcast the same PC-FAX to several recipients at one time.

1. Launch  (**Brother Utilities**), and then click the drop-down list and select your model name (if not already selected).
2. Click **PC-FAX** in the left navigation bar, and then click **Address Book (Send)**.

The **Address Book** dialog box appears.

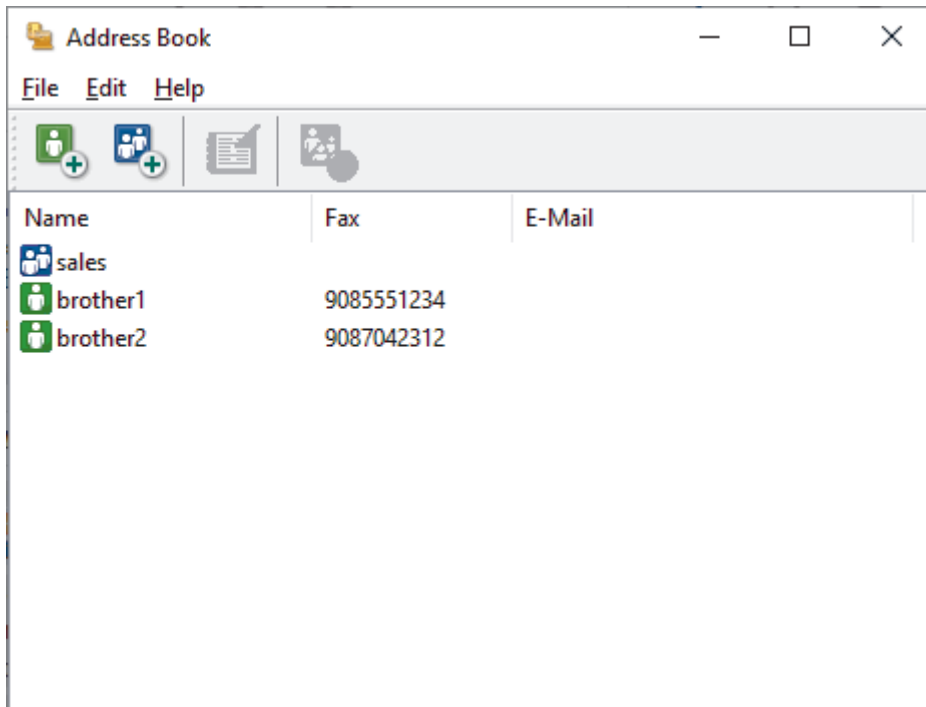

3. Click .

The **Address Book Group Setup** dialog box appears.

4. Type the name of the new group in the **Group Name** field.
5. In the **Available Names** field, select each name you want to include in the group, and then click **Add >>**.  
Members added to the group appear in the **Group Members** box.
6. When finished, click **OK**.

 Each group can contain up to 50 members.

### Related Information

- [Configure your PC-Fax Address Book \(Windows\)](#)

## Edit Member or Group Information in your PC-FAX Address Book (Windows)

1. Launch  (**Brother Utilities**), and then click the drop-down list and select your model name (if not already selected).
2. Click **PC-FAX** in the left navigation bar, and then click **Address Book (Send)**.

The **Address Book** dialog box appears.

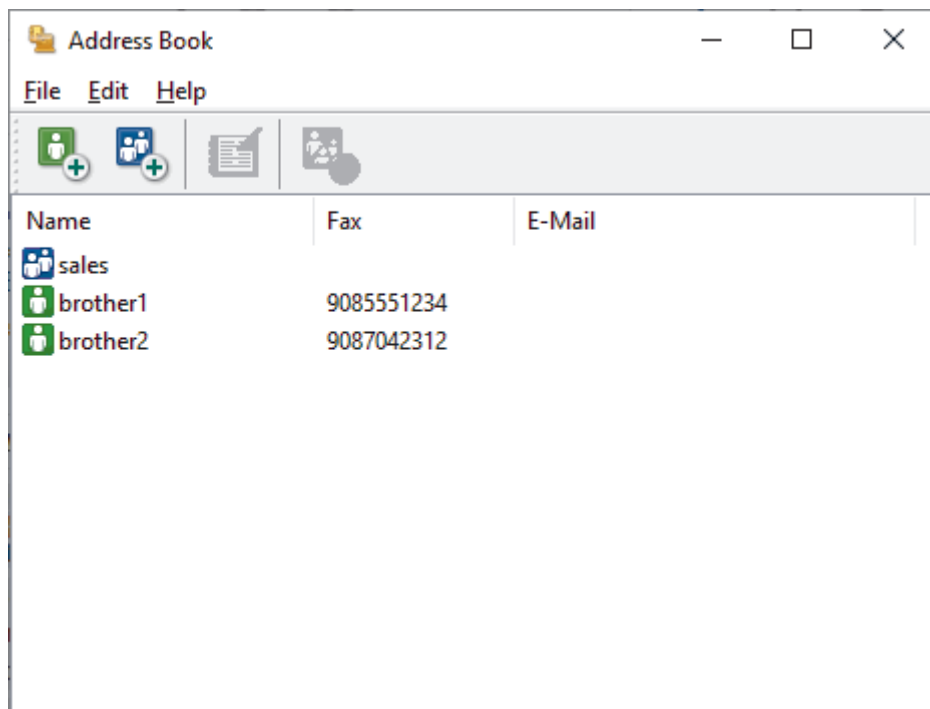

3. Select the member or group you want to edit.
4. Click  (**Properties**).
5. Change the member or group information.
6. Click **OK**.

### Related Information

- [Configure your PC-Fax Address Book \(Windows\)](#)

## Delete a Member or Group in your PC-FAX Address Book (Windows)

1. Launch  (**Brother Utilities**), and then click the drop-down list and select your model name (if not already selected).
2. Click **PC-FAX** in the left navigation bar, and then click **Address Book (Send)**.

The **Address Book** dialog box appears.

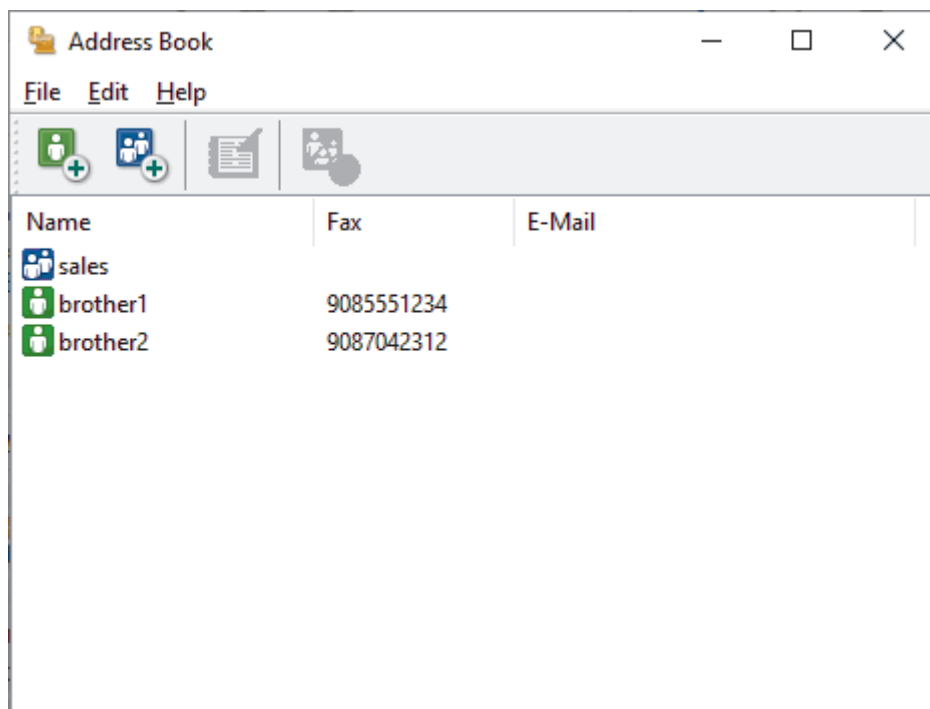

3. Select the member or group you want to delete.
4. Click  (**Delete**).
5. When the confirmation dialog box appears, click **OK**.

### Related Information

- [Configure your PC-Fax Address Book \(Windows\)](#)



## Export your PC-FAX Address Book (Windows)

You can export the Address Book as an ASCII text file (\*.csv) or a vCard (an electronic business card) and save it on your computer.

You cannot export the group settings when you export the **Address Book** data.

1. Launch  (**Brother Utilities**), and then click the drop-down list and select your model name (if not already selected).
2. Click **PC-FAX** in the left navigation bar, and then click **Address Book (Send)**.

The **Address Book** dialog box appears.

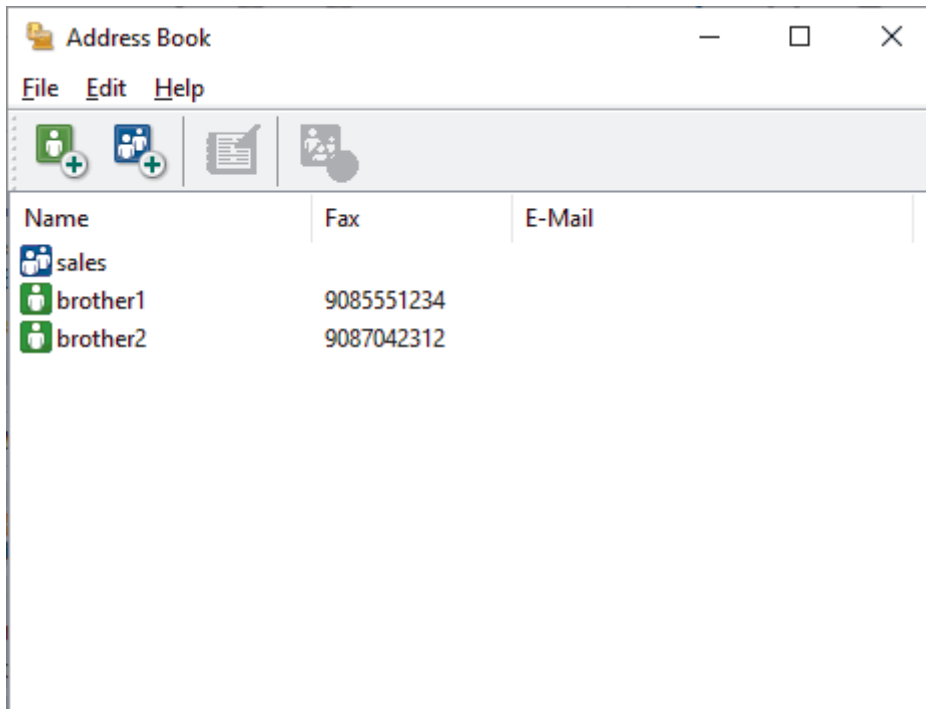

3. Click **File > Export**.
4. Select one of the following:
  - **Text**  
The **Select Items** dialog box appears. Go to the next step.
  - **vCard**  
You must select the member you want to export from your address book before selecting this option. Browse to the folder where you want to save the vCard, type the vCard name in the **File name** field, and then click **Save**.
5. In the **Available Items** field, select the data you want to export, and then click **Add >>**.



Select and add the items in the order you want them listed.

6. If you are exporting to an ASCII file, under the **Divide Character** section, select the **Tab** or **Comma** option to separate the data fields.
7. Click **OK**.
8. Browse to the folder on your computer where you want to save the data, type the file name, and then click **Save**.



## Related Information

- [Configure your PC-Fax Address Book \(Windows\)](#)
-

## Import Information to your PC-FAX Address Book (Windows)

You can import ASCII text files (\*.csv) or vCards (electronic business cards) into your Address Book.

1. Launch  (**Brother Utilities**), and then click the drop-down list and select your model name (if not already selected).
2. Click **PC-FAX** in the left navigation bar, and then click **Address Book (Send)**.

The **Address Book** dialog box appears.

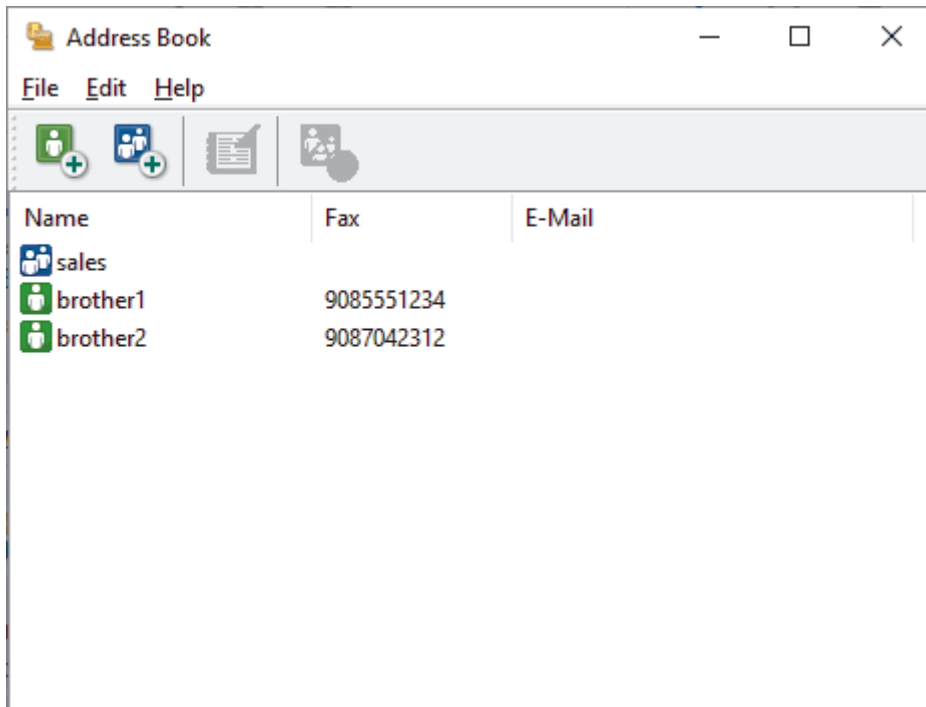

3. Click **File > Import**.
4. Select one of the following:
  - **Text**  
The **Select Items** dialog box appears. Go to step 5.
  - **vCard**  
Go to step 8.
5. In the **Available Items** field, select the data you want to import, and then click **Add >>**.



You must select and add fields from the **Available Items** list in the same order they are listed in the import text file.

6. If you are importing an ASCII file, under the **Divide Character** section, select the **Tab** or **Comma** option to separate the data fields.
7. Click **OK**.
8. Browse to the folder where you want to import the data, type the file name, and then click **Open**.



### Related Information

- [Configure your PC-Fax Address Book \(Windows\)](#)

## Send a Fax Using PC-FAX (Windows)

PC-FAX supports only monochrome faxes. A monochrome fax will be sent even if the original data is colour and the receiving fax machine supports colour faxes.

1. Create a file in any application on your computer.
2. Select the print command in your application.
3. Select **Brother PC-FAX** as your printer, and then complete your print operation.

The **Brother PC-FAX** dialog box appears.

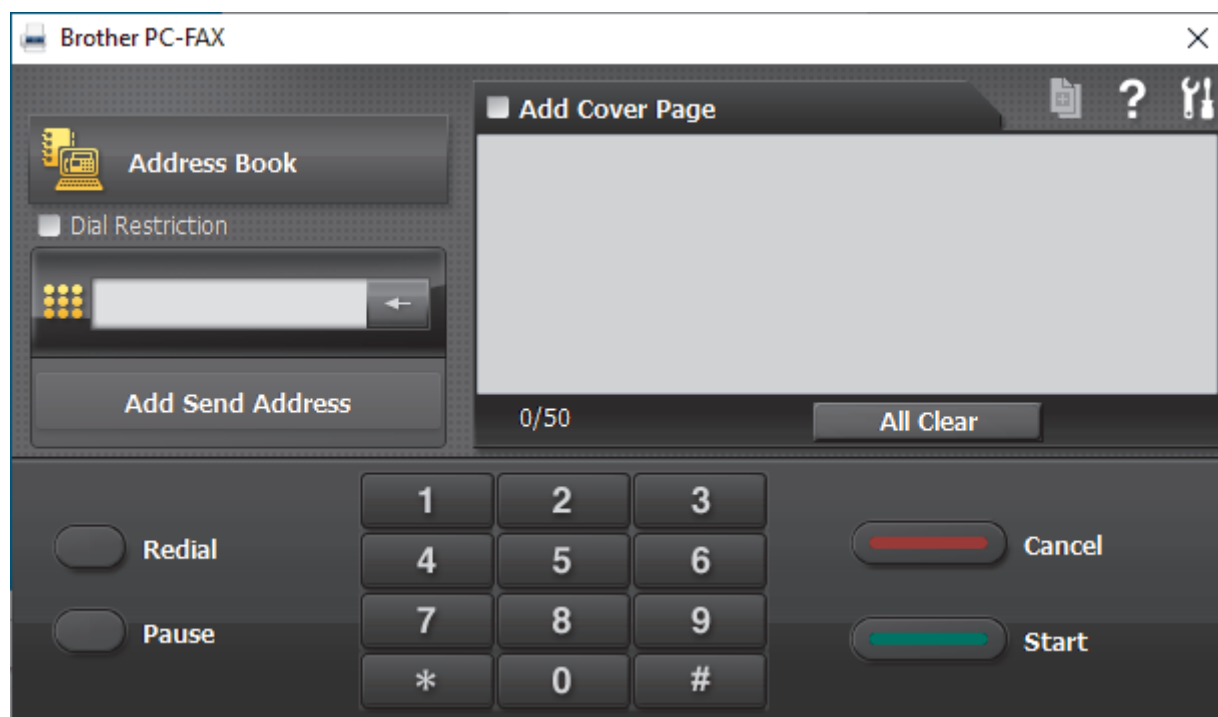

4. Type a fax number using one of the following methods:
  - Click the numbers on the dial pad to type the number, and then click **Add Send Address**.

 If you select the **Dial Restriction** checkbox, a confirmation dialog box will appear for you to re-type the fax number using the keyboard. This feature helps to prevent transmissions to the wrong destination.

- Click the **Address Book** button, and then select a member or group from the Address Book.

 If you make a mistake, click **All Clear** to delete all entries.

5. To include a cover page, select the **Add Cover Page** checkbox. You can also click  to create or edit a cover page.
6. Click **Start** to send the fax.

- To cancel the fax, click **Cancel**.
- To redial a number, click **Redial** to show the last five fax numbers, select a number, and then click **Start**.

### Related Information

- [PC-FAX for Windows](#)

## Receive Faxes on Your Computer (Windows)

Use the Brother PC-FAX software to receive faxes on your computer, screen them and print only those faxes you want.

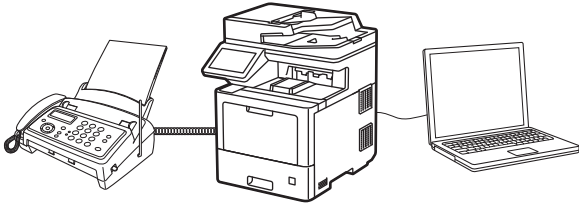

- [Receive Faxes Using PC-FAX Receive \(Windows\)](#)

## Receive Faxes Using PC-FAX Receive (Windows)

The Brother PC-FAX Receive software lets you view and store faxes on your computer. It is automatically installed when you install your machine's software and drivers and works on locally or network-connected machines.

PC-FAX Receive supports only monochrome faxes.

When you turn off your computer, your machine will continue to receive and store faxes in your machine's memory. The machine's LCD will display the number of stored faxes received. When you start this application, the software will transfer all received faxes to your computer at once. You can enable the Backup Print option if you want the machine to print a copy of the fax before the fax is sent to your computer, or before the computer is switched off. You can configure the Backup Print settings from your machine.

### Related Information

- [Receive Faxes on Your Computer \(Windows\)](#)
  - [Run the Brother PC-FAX Receive on Your Computer \(Windows\)](#)
  - [View Received PC-FAX Messages \(Windows\)](#)

## Run the Brother PC-FAX Receive on Your Computer (Windows)



We recommend selecting the **Start PC-FAX Receive on computer startup** checkbox so that the software runs automatically and can transfer any faxes upon computer startup.

1. Launch  (**Brother Utilities**), and then click the drop-down list and select your model name (if not already selected).
2. Click **PC-FAX** in the left navigation bar, and then click **Receive**.
3. Confirm the message and click **Yes**.

The **PC-FAX Receive** window appears. The  (**PC-Fax Receive (Ready)**) icon also appears in your computer task tray.



### Related Information

- [Receive Faxes Using PC-FAX Receive \(Windows\)](#)
  - [Set Up Your Computer for PC-FAX Receiving \(Windows\)](#)
  - [Add Your Machine to PC-FAX Receiving \(Windows\)](#)

## Set Up Your Computer for PC-FAX Receiving (Windows)

1. Double-click the  (PC-Fax Receive (Ready)) icon in your computer task tray.

The **PC-FAX Receive** window appears.

2. Click **Settings**.
3. Configure these options as needed:

### Preferences

Configure to start PC-FAX Receive automatically when you start Windows.

### Save

Configure the path to save PC-FAX files and select the received document format.

### Upload to

Configure the path to the server and select the option to upload automatically or manually (available only for Administrators).

### Device

Select the machine where you want to receive PC-FAX files.

### Lock (available only for Administrators)

Restrict users who do not have administrator privileges from configuring the settings options shown above.

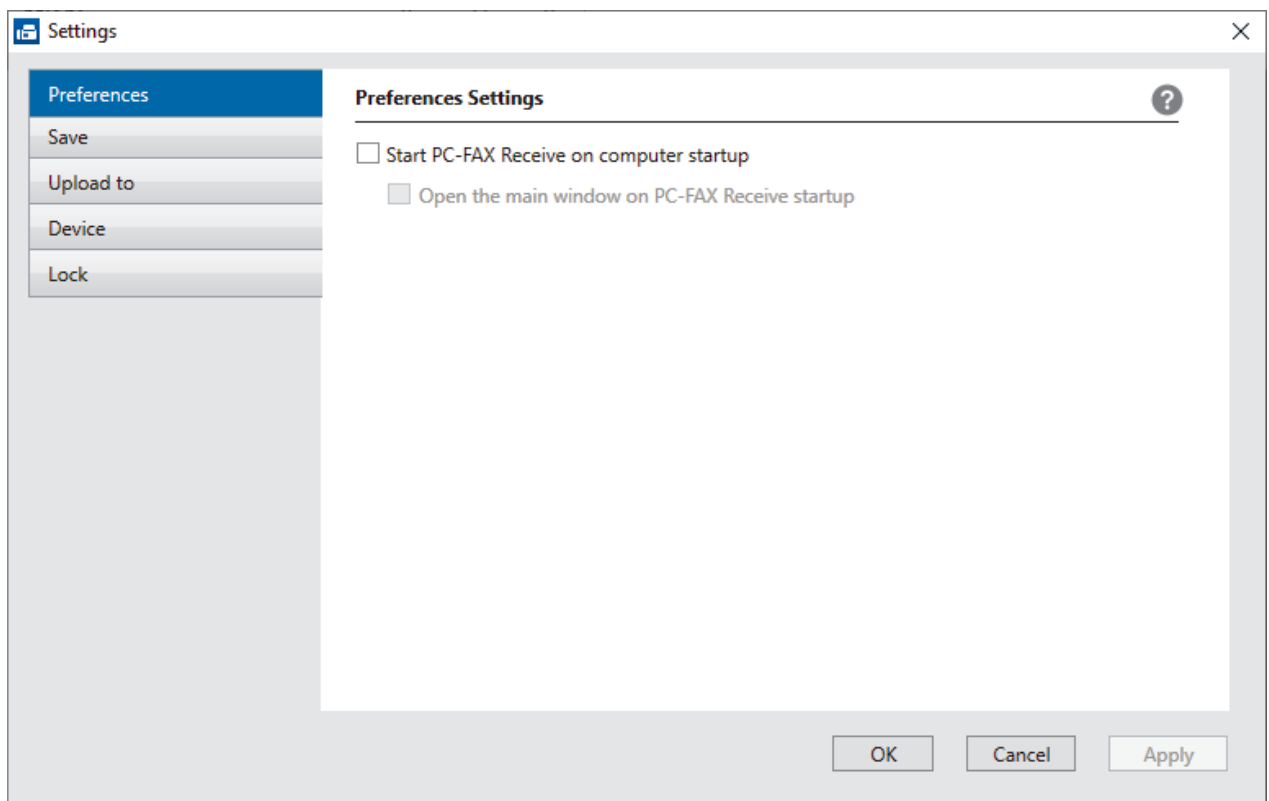

4. Click **OK**.



### Related Information

- [Run the Brother PC-FAX Receive on Your Computer \(Windows\)](#)



## Add Your Machine to PC-FAX Receiving (Windows)

If you installed the machine following the instructions for a network user, then the machine should already be configured for your network.

1. Double-click the  (**PC-Fax Receive (Ready)**) icon in your computer task tray.  
The **PC-FAX Receive** window appears.
2. Click **Settings**.
3. Click **Device > Add**.

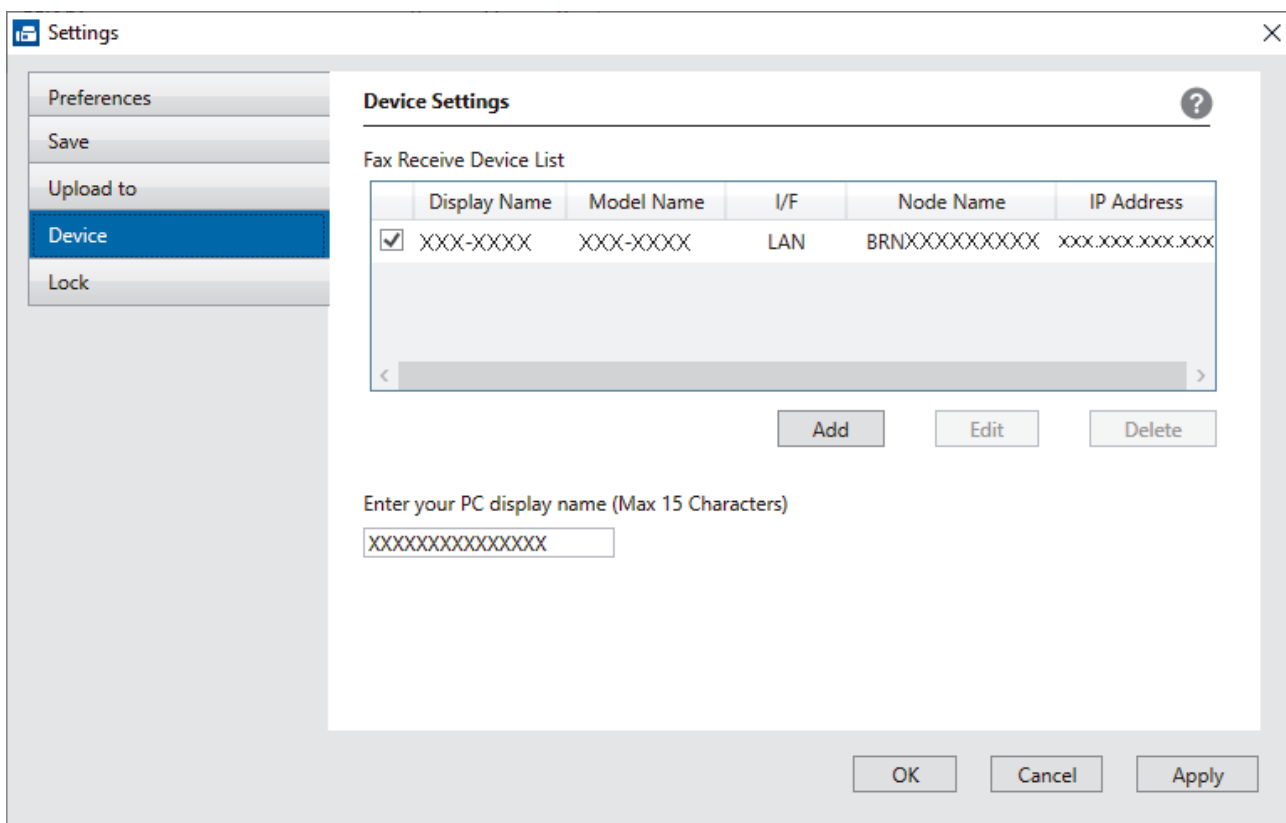



4. Select the correct connection method.  
**Select your machine from the automatic search results below.**  
A list of connected machines appears. Select the machine you want. Click **OK**.  
**Specify your machine by IP address**  
Type the machine's IP address in the **IP Address** field, and then click **OK**.
5. To change the computer name that will appear on the machine's LCD, type the new name in the **Enter your PC display name (Max 15 Characters)** field.
6. Click **OK**.

### Related Information

- [Run the Brother PC-FAX Receive on Your Computer \(Windows\)](#)

## View Received PC-FAX Messages (Windows)

### Receiving Status

| Icon  | Status                               |
|---|--------------------------------------|
|  | Standby mode<br>No unread messages   |
|  | Receiving messages                   |
|  | Messages received<br>Unread messages |

1. Double-click the  (PC-Fax Receive (Ready)) icon in your computer task tray.

The PC-FAX Receive window appears.

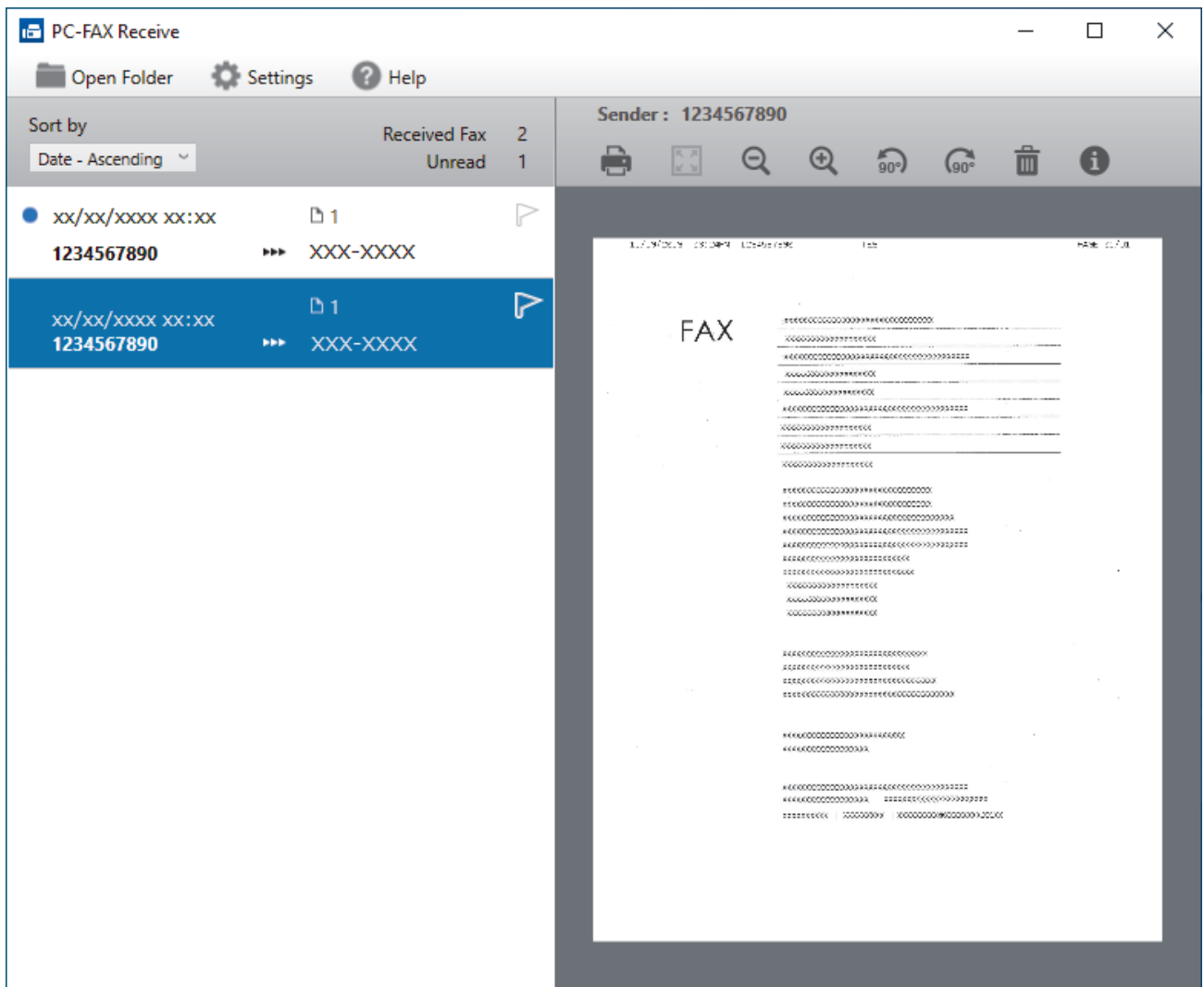

2. Click any faxes in the list to view them.
3. When finished, close the window.



Even after closing the window, PC-FAX Receive is active and the  (PC-Fax Receive (Ready)) icon will remain in your computer task tray. To close PC-FAX Receive, click the icon in the computer task tray and click **Close**.



## Related Information

- [Receive Faxes Using PC-FAX Receive \(Windows\)](#)
-

## PC-FAX for Mac

- [Send a Fax Using AirPrint \(macOS\)](#)

## Network

- [Supported Basic Network Features](#)
- [Configure Network Settings](#)
- [Wireless Network Settings](#)
- [Network Features](#)

## Supported Basic Network Features

The machine supports various features depending on the operating system. Use this table to see which network features and connections are supported by each operating system.

| Operating Systems                                  | Windows 10<br>Windows 8.1<br>Windows 7 | Windows Server<br>2019/2016/2012<br>R2/2012/2008 R2/2008 | macOS v11<br>macOS v10.15.x<br>macOS v10.14.x |
|--|--|--|---|
| Printing   | Yes                                    | Yes  | Yes   |
| Scanning   | Yes                                    |  | Yes   |
| PC Fax Send (available only for certain models)    | Yes                                    |  | Yes   |
| PC Fax Receive (available only for certain models) | Yes                                    |  |   |
| Web Based Management <sup>1</sup>                  | Yes                                    | Yes  | Yes   |
| Status Monitor                                     | Yes                                    |  |   |
| Driver Deployment Wizard                           | Yes                                    | Yes  |   |

<sup>1</sup> The default password to manage this machine's settings is located on the back of the machine and marked "Pwd". We recommend immediately changing the default password to protect your machine from unauthorised access.



When connecting your machine to an outside network such as the Internet, make sure your network environment is protected by a separate firewall or other means in order to prevent information leaks due to inadequate settings or unauthorised access by malicious third parties.



### Related Information

- [Network](#)

#### Related Topics:

- [Set or Change a Login Password for Web Based Management](#)

## Configure Network Settings

- [Configure Network Details Using the Control Panel](#)
- [Change Machine Settings Using Web Based Management](#)

## Configure Network Details Using the Control Panel

To configure the machine for your network, use the control panel's [Network] menu selections.



- For information about the network settings you can configure using the control panel, see *Related Information: Settings Tables*.
- You can also use Web Based Management to configure and change your machine's network settings.

1. Press  [Settings] > [All Settings] > [Network].



If your machine displays the [All Settings] menu on the Home screen, skip the [Settings] menu.

2. Swipe up or down or press ▲ or ▼ to display the network option you want, and then press it. Repeat this step until you access the menu you want to configure, and then follow the LCD instructions.



### Related Information

- [Configure Network Settings](#)

#### Related Topics:

- [Settings Tables](#)
- [Supported Basic Network Features](#)



## Wireless Network Settings

- [Use the Wireless Network](#)
- [Use Wi-Fi Direct<sup>®</sup>](#)
- [Enable/Disable Wireless LAN](#)
- [Print the WLAN Report](#)

## Use the Wireless Network

- [Before Configuring Your Machine for a Wireless Network](#)
- [Configure Your Machine for a Wireless Network Using the Setup Wizard from Your Computer](#)
- [Configure Your Machine for a Wireless Network Using the Machine's Control Panel Setup Wizard](#)
- [Configure Your Machine for a Wireless Network Using the One Push Method of Wi-Fi Protected Setup™ \(WPS\)](#)
- [Configure Your Machine for a Wireless Network Using the PIN Method of Wi-Fi Protected Setup™ \(WPS\)](#)
- [Configure Your Machine for a Wireless Network When the SSID Is Not Broadcast](#)
- [Configure Your Machine for an Enterprise Wireless Network](#)

## Before Configuring Your Machine for a Wireless Network

### NOTE

The wireless network connection can be used only when the optional Wireless Module is installed.

Before attempting to configure a wireless network, confirm the following:

- If you are using an enterprise wireless network, you must know the User ID and Password.
- To achieve optimum results with normal everyday document printing, place your machine as close to the wireless LAN access point/router as possible with minimal obstructions. Large objects and walls between the two devices and interference from other electronic devices can affect the data transfer speed of your documents.

Due to these factors, wireless may not be the best method of connection for all types of documents and applications. If you are printing large files, such as multi-page documents with mixed text and large graphics, you may want to consider selecting wired Ethernet for faster data transfer (supported models only), or USB for the fastest throughput speed.

- Although your machine can be used in both a wired and wireless network (supported models only), only one connection method can be used at a time. However, a wireless network connection and Wi-Fi Direct connection, or a wired network connection (supported models only) and Wi-Fi Direct connection can be used at the same time.
- If there is a signal in the vicinity, wireless LAN allows you to freely make a LAN connection. However, if security settings are not correctly configured, the signal may be intercepted by malicious third-parties, possibly resulting in:
  - Theft of personal or confidential information
  - Improper transmission of information to parties impersonating the specified individuals
  - Dissemination of transcribed communication contents that were intercepted



Make sure you know your wireless router/access point's Network Name (SSID) and Network Key (Password). If you cannot find this information, consult the manufacturer of your wireless router/access point, your system administrator, or Internet provider. Brother cannot provide this information.



### Related Information

- [Use the Wireless Network](#)

## Configure Your Machine for a Wireless Network Using the Setup Wizard from Your Computer

### NOTE

The wireless network connection can be used only when the optional Wireless Module is installed.

1. Download the installer from your model's **Downloads** page at [support.brother.com](http://support.brother.com).
2. Start the installer, and then follow the on-screen instructions.
3. Select **Wireless Network Connection (Wi-Fi)** or **Wireless Network Connection (Wi-Fi) (Optional)**, and then click **Next**.
4. Follow the on-screen instructions.

You have completed the wireless network setup.



### Related Information

- [Use the Wireless Network](#)

## Configure Your Machine for a Wireless Network Using the Machine's Control Panel Setup Wizard

### NOTE

The wireless network connection can be used only when the optional Wireless Module is installed.

Before configuring your machine, we recommend writing down your wireless network settings. You will need this information before you continue with the configuration.

1. Check and record the current wireless network settings of the computer to which you are connecting.

#### Network Name (SSID)

#### Network Key (Password)

For example:

#### Network Name (SSID)

HELLO

#### Network Key (Password)

12345



- Your access point/router may support the use of multiple WEP keys, but your Brother machine supports the use of only the first WEP key.
- If you need assistance during setup and want to contact Brother customer service, make sure you have your SSID (Network Name) and Network Key (Password) ready. We cannot assist you in locating this information.
- If you do not know this information (SSID and Network Key), you cannot continue the wireless setup.

#### How can I find this information?

- a. Check the documentation provided with your wireless access point/router.
- b. The initial SSID could be the manufacturer's name or the model name.
- c. If you do not know the security information, consult the router manufacturer, your system administrator, or your Internet provider.

2. Press  [Settings] > [All Settings] > [Network] > [WLAN (Wi-Fi)] > [Find Wi-Fi Network].



If your machine displays the [All Settings] menu on the Home screen, skip the [Settings] menu.

3. When [Enable WLAN?] appears, press [Yes].

This will start the wireless setup wizard. To cancel, press [No].

4. The machine will search for your network and display a list of available SSIDs.

If a list of SSIDs is displayed, swipe up or down or press ▲ or ▼ to display the SSID to which you want to connect, and then press the SSID.

5. Press [OK].

---

6. Do one of the following:

- If you are using an authentication and encryption method that requires a Network Key, enter the Network Key you wrote down in the first step.

When you have entered all the characters, press [OK].

- If your authentication method is Open System and your encryption mode is None, go to the next step.

7. The machine attempts to connect to the wireless device you have selected.

If your wireless device is connected successfully, the machine's LCD displays [Connected], and then press [OK]. Press .

You have completed the wireless network setup. To install the drivers or your application necessary for operating your device, go to your model's **Downloads** page at [support.brother.com](http://support.brother.com).

### Related Information

- [Use the Wireless Network](#)

#### Related Topics:

- [How to Enter Text on Your Machine](#)
  - [Wireless LAN Report Error Codes](#)
-

## Configure Your Machine for a Wireless Network Using the One Push Method of Wi-Fi Protected Setup™ (WPS)

### NOTE

The wireless network connection can be used only when the optional Wireless Module is installed.

If your wireless access point/router supports WPS (PBC: Push Button Configuration), you can use WPS from your machine's control panel menu to configure your wireless network settings.

1. Press  [Settings] > [All Settings] > [Network] > [WLAN (Wi-Fi)] > [WPS/Push Button].



If your machine displays the [All Settings] menu on the Home screen, skip the [Settings] menu.

2. When [Enable WLAN?] appears, press [Yes].  
This will start the wireless setup wizard. To cancel, press [No].
3. When the touchscreen displays [Start WPS on your wireless access point/router, then press [OK].], press the WPS button on your wireless access point/router. Then press [OK] on your machine. Your machine will automatically detect your wireless access point/router and try to connect to your wireless network.

If your wireless device is connected successfully, the machine's LCD displays [Connected], and then press [OK]. Press .

You have completed the wireless network setup. To install the drivers and software necessary to use your machine, go to your model's **Downloads** page at [support.brother.com](http://support.brother.com).



### Related Information

- [Use the Wireless Network](#)

#### Related Topics:

- [Wireless LAN Report Error Codes](#)

## Configure Your Machine for a Wireless Network Using the PIN Method of Wi-Fi Protected Setup™ (WPS)

### NOTE

The wireless network connection can be used only when the optional Wireless Module is installed.

If your wireless LAN access point/router supports WPS, you can use the Personal Identification Number (PIN) Method to configure your wireless network settings.

The PIN Method is one of the connection methods developed by the Wi-Fi Alliance®. By submitting a PIN created by an Enrollee (your machine) to the Registrar (a device that manages the wireless LAN), you can set up the wireless network and security settings. For more information on how to access WPS mode, see the instructions provided with your wireless access point/router.

#### Type A

Connection when the wireless LAN access point/router (1) doubles as the Registrar:

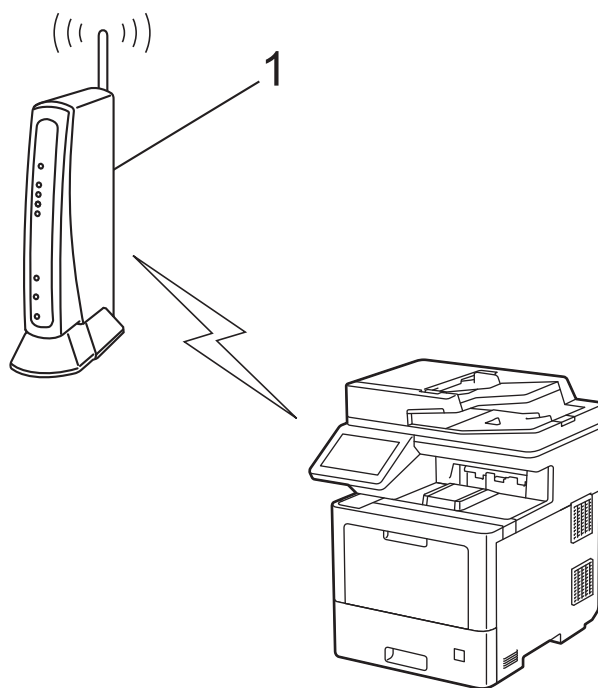



#### Type B

Connection when another device (2), such as a computer, is used as the Registrar:

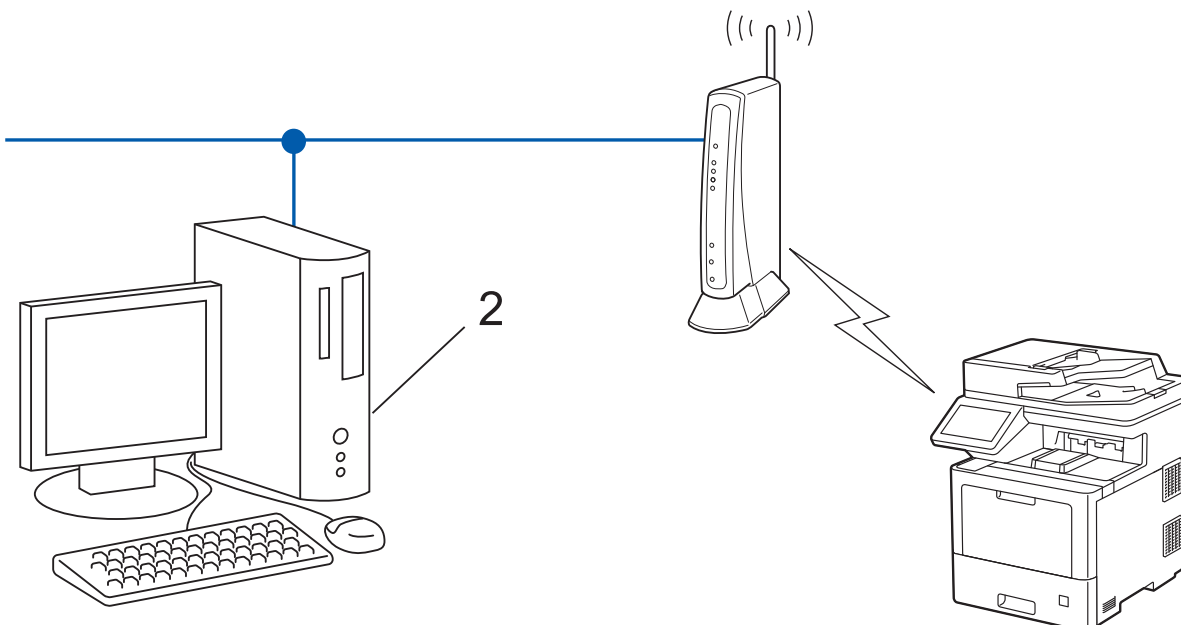





1. Press  [Settings] > [All Settings] > [Network] > [WLAN (Wi-Fi)] > [WPS/PIN Code].

 If your machine displays the [All Settings] menu on the Home screen, skip the [Settings] menu.

2. When [Enable WLAN?] appears, press [Yes].  
This will start the wireless setup wizard. To cancel, press [No].
3. The LCD displays an eight-digit PIN and the machine starts searching for a wireless LAN access point/router.
4. Using a computer connected to the network, in your browser's address bar, type the IP address of the device you are using as the Registrar. (For example: <http://192.168.1.2>)
5. Go to the WPS settings page and type the PIN, and then follow the on-screen instructions.

- 
- The Registrar is usually the wireless LAN access point/router.
  - The settings page may differ depending on the brand of wireless LAN access point/router. For more information, see the instructions supplied with your wireless LAN access point/router.

**If you are using a Windows 7, Windows 8.1, or Windows 10 computer as a Registrar, complete the following steps:**

6. Do one of the following:
  - Windows 10  
Click  > **Windows System** > **Control Panel**. In the **Hardware and Sound** group, click **Add a device**.
  - Windows 8.1  
Move your mouse to the lower right corner of your desktop. When the menu bar appears, click **Settings** > **Control Panel** > **Hardware and Sound** > **View devices and printers** > **Add a device**.
  - Windows 7  
Click  (**Start**) > **Devices and Printers** > **Add a device**.

- 
- To use a Windows 7, Windows 8.1, or Windows 10 computer as a Registrar, you must register it to your network in advance. For more information, see the instructions supplied with your wireless LAN access point/router.
  - If you use Windows 7, Windows 8.1, or Windows 10 as a Registrar, you can install the printer driver after the wireless configuration by following the on-screen instructions. To install the driver and software necessary to use your machine, go to your model's **Downloads** page at [support.brother.com](http://support.brother.com).

7. Select your machine and click **Next**.

- 
8. Type the PIN displayed on the machine's LCD, and then click **Next**.
  9. (Windows 7) Select your network, and then click **Next**.
  10. Click **Close**.

If your wireless device is connected successfully, the machine's LCD displays [Connected], and then press [OK]. Press .

You have completed the wireless network setup. To install the drivers or your application necessary for operating your device, go to your model's **Downloads** page at [support.brother.com](http://support.brother.com).



### Related Information

- [Use the Wireless Network](#)

#### Related Topics:

- [Wireless LAN Report Error Codes](#)
-

## Configure Your Machine for a Wireless Network When the SSID Is Not Broadcast

### NOTE

The wireless network connection can be used only when the optional Wireless Module is installed.

Before configuring your machine, we recommend writing down your wireless network settings. You will need this information before you continue with the configuration.

1. Check and write down the current wireless network settings.

| Network Name (SSID) |
|---------------------|
|                     |

| Authentication Method | Encryption Mode | Network Key |
|-----------------------|-----------------|-------------|
| Open System           | NONE            | -           |
|                       | WEP             |             |
| Shared Key            | WEP             |             |
| WPA/WPA2-PSK          | AES             |             |
|                       | TKIP            |             |

For example:

| Network Name (SSID) |
|---------------------|
| HELLO               |

| Authentication Method | Encryption Mode | Network Key |
|-----------------------|-----------------|-------------|
| WPA2-PSK              | AES             | 12345678    |



If your router uses WEP encryption, enter the key used as the first WEP key. Your Brother machine supports the use of the first WEP key only.

2. Press  [Settings] > [All Settings] > [Network] > [WLAN (Wi-Fi)] > [Find Wi-Fi Network].



If your machine displays the [All Settings] menu on the Home screen, skip the [Settings] menu.

3. When [Enable WLAN?] appears, press [Yes].  
This will start the wireless setup wizard. To cancel, press [No].
4. The machine will search for your network and display a list of available SSIDs. Swipe up or down or press ▲ or ▼ to display [<New SSID>]. Press [<New SSID>], and then press [OK].
5. Enter the SSID name, and then press [OK].
6. Select the Authentication Method.
7. Do one of the following:
  - If you selected the [Open System] option, press the Encryption type [None] or [WEP].  
If you selected the [WEP] option for Encryption type, select and enter the WEP key, and then press [OK].
  - If you selected the [Shared Key] option, select and enter the WEP key, and then press [OK].
  - If you selected the [WPA/WPA2-PSK] option, press the Encryption type [TKIP+AES] or [AES].

---

Enter the WPA™ key, and then press [OK].



Your Brother machine supports the use of the first WEP key only.

8. The machine attempts to connect to the wireless device you have selected.

If your wireless device is connected successfully, the machine's LCD displays [Connected], and then press [OK]. Press .

You have completed the wireless network setup. To install the drivers or your application necessary for operating your device, go to your model's **Downloads** page at [support.brother.com](http://support.brother.com).



### Related Information

- [Use the Wireless Network](#)

#### Related Topics:

- [I Cannot Complete the Wireless Network Setup Configuration](#)
  - [How to Enter Text on Your Machine](#)
  - [Wireless LAN Report Error Codes](#)
-

## Configure Your Machine for an Enterprise Wireless Network

### NOTE

The wireless network connection can be used only when the optional Wireless Module is installed.

Before configuring your machine, we recommend writing down your wireless network settings. You will need this information before you continue with the configuration.

1. Check and record the current wireless network settings.

| Network Name (SSID)   |                 |         |          |
|-----------------------|-----------------|---------|----------|
|                       |                 |         |          |
| Authentication Method | Encryption Mode | User ID | Password |
| EAP-FAST/NONE         | AES             |         |          |
|                       | TKIP            |         |          |
| EAP-FAST/MS-CHAPv2    | AES             |         |          |
|                       | TKIP            |         |          |
| EAP-FAST/GTC          | AES             |         |          |
|                       | TKIP            |         |          |
| PEAP/MS-CHAPv2        | AES             |         |          |
|                       | TKIP            |         |          |
| PEAP/GTC              | AES             |         |          |
|                       | TKIP            |         |          |
| EAP-TTLS/CHAP         | AES             |         |          |
|                       | TKIP            |         |          |
| EAP-TTLS/MS-CHAP      | AES             |         |          |
|                       | TKIP            |         |          |
| EAP-TTLS/MS-CHAPv2    | AES             |         |          |
|                       | TKIP            |         |          |
| EAP-TTLS/PAP          | AES             |         |          |
|                       | TKIP            |         |          |
| EAP-TLS               | AES             |         | -        |
|                       | TKIP            |         | -        |

For example:

| Network Name (SSID)   |                 |         |          |
|-----------------------|-----------------|---------|----------|
| HELLO                 |                 |         |          |
| Authentication Method | Encryption Mode | User ID | Password |
| EAP-FAST/MS-CHAPv2    | AES             | Brother | 12345678 |



- If you configure your machine using EAP-TLS authentication, you must install the client certificate issued by a CA before you start configuration. Contact your network administrator about the client certificate. If you have installed more than one certificate, we recommend writing down the certificate name you want to use.
- If you verify your machine using the common name of the server certificate, we recommend writing down the common name before you start configuration. Contact your network administrator about the common name of the server certificate.

2. Press  [Settings] > [All Settings] > [Network] > [WLAN (Wi-Fi)] > [Find Wi-Fi Network].



If your machine displays the [All Settings] menu on the Home screen, skip the [Settings] menu.

3. When [Enable WLAN?] appears, press [Yes].

This will start the wireless setup wizard. To cancel, press [No].

4. The machine will search for your network and display a list of available SSIDs. Swipe up or down or press ▲ or ▼ to display [<New SSID>]. Press [<New SSID>], and then press [OK].

5. Enter the SSID name, and then press [OK].

6. Select the Authentication Method.

7. Do one of the following:

- If you selected the [EAP-FAST], [PEAP] or [EAP-TTLS] option, select the Inner Authentication method [NONE], [CHAP], [MS-CHAP], [MS-CHAPv2], [GTC] or [PAP].



Depending on your Authentication method, the Inner Authentication method selections may differ.

Select the encryption type [TKIP+AES] or [AES].

Select the verification method [No Verification], [CA] or [CA + Server ID].

- If you selected the [CA + Server ID] option, enter the server ID, user ID, and password (if required), and then press [OK] for each option.
- For other selections, enter the user ID and Password, and then press [OK] for each option.



If you have not imported a CA certificate into your machine, the machine displays [No Verification].

- If you selected the [EAP-TLS] option, select the encryption type [TKIP+AES] or [AES].

The machine will display a list of available Client Certificates, and then select the certificate.

Select the verification method [No Verification], [CA] or [CA + Server ID].

- If you selected the [CA + Server ID] option, enter the server ID and user ID, and then press [OK] for each option.
- For other selections, enter the user ID, and then press [OK].

8. The machine attempts to connect to the wireless device you have selected.

If your wireless device is connected successfully, the machine's LCD displays [Connected], and then press [OK]. Press .

You have completed the wireless network setup. To install the drivers or your application necessary for operating your device, go to your model's **Downloads** page at [support.brother.com](http://support.brother.com).



## Related Information

- [Use the Wireless Network](#)

### Related Topics:

- [Wireless LAN Report Error Codes](#)

## Use Wi-Fi Direct®

- [Wi-Fi Direct Overview](#)
- [Configure Your Wi-Fi Direct Network Manually](#)
- [Configure Wi-Fi Direct Network Using the Push Button Method](#)

## Wi-Fi Direct Overview

### NOTE

The wireless network connection can be used only when the optional Wireless Module is installed.

Wi-Fi Direct is one of the wireless configuration methods developed by the Wi-Fi Alliance®. It allows you to securely connect your mobile device to your machine without using a wireless router/access point.

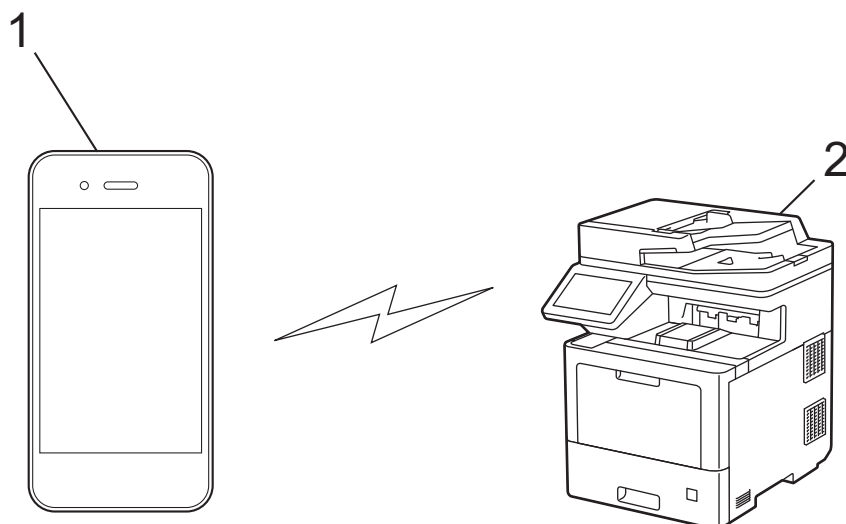

1. Mobile device
2. Your machine



- You can use Wi-Fi Direct with either the wired or wireless network connection at the same time.
- The Wi-Fi Direct-supported device can become a Group Owner. When configuring the Wi-Fi Direct network, the Group Owner serves as an access point.

### ✓ Related Information

- [Use Wi-Fi Direct®](#)

#### Related Topics:

- [Configure Your Wi-Fi Direct Network Manually](#)
- [Configure Wi-Fi Direct Network Using the Push Button Method](#)



## Configure Your Wi-Fi Direct Network Manually

### NOTE

The wireless network connection can be used only when the optional Wireless Module is installed.

Configure the Wi-Fi Direct settings from the machine's control panel:



When the machine receives a Wi-Fi Direct request from your mobile device, the message [Wi-Fi Direct connection request received. Press [OK] to connect.] appears on the LCD. Press [OK] to connect.

1. Press  [Settings] > [All Settings] > [Network] > [Wi-Fi Direct] > [Manual].



If your machine displays the [All Settings] menu on the Home screen, skip the [Settings] menu.

2. The machine will display the SSID (Network Name) and Password (Network Key). Go to your mobile device's wireless network settings screen, select the SSID, and then enter the password.
3. When your mobile device connects successfully, the machine's LCD displays [Connected]. Press [Close], and then press .



### Related Information

- [Use Wi-Fi Direct®](#)

#### Related Topics:

- [Wi-Fi Direct Overview](#)
- [Configure Wi-Fi Direct Network Using the Push Button Method](#)



## Configure Wi-Fi Direct Network Using the Push Button Method

### NOTE

The wireless network connection can be used only when the optional Wireless Module is installed.

 When the machine receives a Wi-Fi Direct request from your mobile device, the message [Wi-Fi Direct connection request received. Press [OK] to connect.] appears on the LCD. Press [OK] to connect.

1. Press  [Settings] > [All Settings] > [Network] > [Wi-Fi Direct] > [Push Button] on your machine's LCD.

-  If your mobile device does not support Wi-Fi Direct, do the following:
- a. Press  [Settings] > [All Settings] > [Network] > [Wi-Fi Direct] > [Group Owner], and then press [On].
  - b. Swipe up or down or press ▲ or ▼ to select the [Push Button].
- If your machine displays the [All Settings] menu on the Home screen, skip the [Settings] menu.

2. When the [Activate Wi-Fi Direct on other device. Then Press [OK].] message appears, turn your mobile device's Wi-Fi Direct function on (for more information, see your mobile device's user's guide). Press [OK] on your machine.
3. Do one of the following:
  - If your mobile device displays a list of machines with Wi-Fi Direct enabled, select your Brother machine.
  - If your Brother machine displays a list of mobile devices with Wi-Fi Direct enabled, select your mobile device. To search for available devices again press [Rescan].
4. When your mobile device connects successfully, the machine's LCD displays [Connected]. Press [Close], and the press .

### Related Information

- [Use Wi-Fi Direct®](#)

#### Related Topics:

- [Wi-Fi Direct Overview](#)
- [Configure Your Wi-Fi Direct Network Manually](#)

## Enable/Disable Wireless LAN

### NOTE

The wireless network connection can be used only when the optional Wireless Module is installed.

1. Press  [Settings] > [All Settings] > [Network] > [WLAN (Wi-Fi)].



If your machine displays the [All Settings] menu on the Home screen, skip the [Settings] menu.

2. Swipe up or down or press ▲ or ▼ to select the [WLAN Enable] option. Press [WLAN Enable].
3. Do one of the following:
  - To enable Wi-Fi, select [On].
  - To disable Wi-Fi, select [Off].
4. Press .



### Related Information

- [Wireless Network Settings](#)

## Print the WLAN Report

### NOTE

The wireless network connection can be used only when the optional Wireless Module is installed.

The WLAN Report shows your machine's wireless status. If the wireless connection fails, check the error code on the printed report.

1. Press  [Settings] > [All Settings] > [Print Reports] > [WLAN Report].



If your machine displays the [All Settings] menu on the Home screen, skip the [Settings] menu.

2. Press [Yes].

The machine prints the WLAN Report.

3. Press .

If the WLAN Report does not print, check your machine for errors. If there are no visible errors, wait for one minute and then try to print the report again.



### Related Information

- [Wireless Network Settings](#)
  - [Wireless LAN Report Error Codes](#)

#### Related Topics:

- [My Machine Cannot Print, Scan, or PC-FAX Receive over the Network](#)
- [I Want to Check that My Network Devices are Working Correctly](#)

## Wireless LAN Report Error Codes

### NOTE

The wireless network connection can be used only when the optional Wireless Module is installed.

If the Wireless LAN Report shows that the connection failed, check the error code on the printed report and see the corresponding instructions in the table:

| Error Code | Problem and Recommended Solutions   |
|------------|---|
| TS-01      | <p>The WLAN (Wi-Fi) setting is not enabled.</p> <p>Check the following points and try to set up your wireless connection again:</p> <ul style="list-style-type: none"><li>• Enable the WLAN setting on your machine.</li><li>• If a network cable is connected to your machine, disconnect it.</li></ul>  |
| TS-02      | <p>The wireless router/access point cannot be detected.</p> <p>Check the following points and try to set up your wireless connection again:</p> <ul style="list-style-type: none"><li>• Make sure the wireless router/access point is on.</li><li>• Temporarily place your machine closer to the wireless router/access point when you are configuring the wireless settings.</li><li>• If your wireless router/access point is using MAC address filtering, confirm that the MAC address of the machine is allowed in the filter. You can find the MAC address by printing the Network Configuration Report.</li><li>• If you manually entered the Network Name (SSID) and security information (authentication method/encryption method), the information may be incorrect. Check the Network Name and security information again and re-enter the correct information.</li><li>• Restart your wireless router/access point. If you cannot find the Network Name (SSID) and security information, see the documentation provided with your wireless router/access point, or contact the router manufacturer, your system administrator, or Internet service provider.</li></ul> |
| TS-03      | <p>The wireless enterprise network and security settings you entered may be incorrect.</p> <p>Check the following points and try to set up your wireless connection again:</p> <p>Verify the following information:</p> <ul style="list-style-type: none"><li>- Network Name (SSID) you selected to configure your machine.</li><li>- Security information you selected to configure your machine (such as the authentication method, encryption method, or User ID).</li></ul> <p>If you still cannot find the Network Name (SSID) and security information, see the documentation provided with your wireless router/access point, or contact the router manufacturer, your system administrator, or Internet service provider.</p>   |

| Error Code | Problem and Recommended Solutions  |
|------------|--|
| TS-04      | <p>Your machine does not support the authentication and encryption methods used by the selected wireless router/access point.</p> <p>For infrastructure mode (Most common)</p> <p>Change the authentication and encryption methods of the wireless router/access point. Your machine supports the following authentication and encryption methods:</p> <ul style="list-style-type: none"> <li>• WPA-Personal:<br/>TKIP / AES</li> <li>• WPA2-Personal:<br/>TKIP / AES</li> <li>• Open:<br/>WEP / NONE (without encryption)</li> <li>• Shared key:<br/>WEP</li> </ul> <p>If your issue is not solved, the Network Name (SSID) or security settings you entered may be incorrect. Check that all wireless network settings are correct for your network.</p>   |
| TS-05      | <p>The Network Name (SSID) and Network Key (Password) are incorrect.</p> <p>Check the following points and try to set up your wireless connection again:</p> <ul style="list-style-type: none"> <li>• Confirm the Network Name (SSID) and Network Key (Password).</li> <li>• If your Network Key contains upper-case and lower-case letters, make sure you type them correctly.</li> <li>• If you cannot find the Network Name (SSID) and security information, see the documentation provided with your wireless router/access point, or contact the router manufacturer, your system administrator, or Internet service provider.</li> <li>• If your wireless router/access point uses WEP encryption with multiple WEP keys, write down and use only the first WEP key.</li> </ul>  |
| TS-06      | <p>The wireless security information (authentication method/encryption method/Network Key (Password)) is incorrect.</p> <p>Check the following points and try to set up your wireless connection again:</p> <ul style="list-style-type: none"> <li>• Confirm the Network Key. If your Network Key contains upper-case and lower-case letters, make sure you type them correctly.</li> <li>• Confirm whether the authentication method entered and the authentication method or encryption method supported by the wireless router/access point are the same.</li> <li>• If the network key, authentication method, and encryption method have been confirmed, restart your wireless router/access point and the machine.</li> <li>• If your wireless router/access point's Stealth Mode is on, you may need to disable it to connect to the wireless network.</li> </ul> <p>If you cannot find the Network Name (SSID) and security information, see the documentation provided with your wireless router/access point, or contact the router manufacturer, your system administrator, or Internet service provider.</p> |
| TS-07      | <p>The machine cannot detect a wireless router/access point that has WPS (Wi-Fi Protected Setup™) enabled.</p> <p>Check the following points and try again:</p> <ul style="list-style-type: none"> <li>• To check if your wireless router/access point supports WPS, look for the WPS symbol displayed on the router/access point. For more information, see the documentation provided with your wireless router/access point.</li> <li>• To set up your wireless connection using WPS, you must configure both your machine and the wireless router/access point. For more information, see the user's guide.</li> <li>• If you do not know how to set up your wireless router/access point using WPS, see the documentation provided with your wireless router/access point, or contact the router manufacturer, your system administrator, or Internet service provider.</li> </ul>  |

| Error Code | Problem and Recommended Solutions   |
|------------|---|
| TS-08      | <p>Two or more wireless routers or access points that have WPS enabled are detected.</p> <p>Check the following points and try again:</p> <ul style="list-style-type: none"> <li>• Make sure that only one wireless router/access point within range has WPS enabled, and then try to connect again.</li> <li>• Try to connect again after a few minutes to avoid interference from other access points/routers.</li> </ul> |



How to confirm wireless security information (SSID/authentication method/encryption method/Network Key) of your WLAN access point/router:

1. The default security settings may be provided on a label attached to the WLAN access point/router. Or the manufacturer's name or model number of the WLAN access point/router may be used as the default security settings.
2. See the documentation provided with your WLAN access point/router for information on how to find the security settings.
  - If the WLAN access point/router is set to not broadcast the SSID, the SSID will not automatically be detected. You will have to manually enter the SSID name.
  - The Network key may also be described as the Password, Security Key, or Encryption Key.

If you do not know the SSID and wireless security settings of your WLAN access point/router or how to change the configuration, see the documentation provided with your WLAN access point/router, ask the manufacturer of your access point/router, or ask your Internet provider or network administrator.



## Related Information

- [Print the WLAN Report](#)

### Related Topics:

- [My Machine Cannot Print, Scan, or PC-FAX Receive over the Network](#)
- [I Want to Check that My Network Devices are Working Correctly](#)
- [Configure Your Machine for a Wireless Network Using the One Push Method of Wi-Fi Protected Setup™ \(WPS\)](#)
- [Configure Your Machine for a Wireless Network Using the PIN Method of Wi-Fi Protected Setup™ \(WPS\)](#)
- [Configure Your Machine for a Wireless Network Using the Machine's Control Panel Setup Wizard](#)
- [Configure Your Machine for a Wireless Network When the SSID Is Not Broadcast](#)
- [Configure Your Machine for an Enterprise Wireless Network](#)

## Network Features

- [Print the Network Configuration Report](#)
- [Fax Using the Internet \(I-Fax\)](#)
- [Use the Send Fax to Server Feature](#)
- [Configure and Operate LDAP Search](#)
- [Synchronise Time with the SNTP Server Using Web Based Management](#)
- [Gigabit Ethernet \(Wired Network Only\)](#)
- [Reset the Network Settings to the Factory Settings](#)



## Print the Network Configuration Report

The Network Configuration Report lists the network configuration, including the network print server settings.



- The Node Name appears on the Network Configuration Report. The default Node Name is "BRNxxxxxxxxxxx" for a wired network or "BRWxxxxxxxxxxx" for a wireless network (where "xxxxxxxxxxx" is your machine's MAC Address / Ethernet Address.)
- If the IP Address on the Network Configuration Report shows 0.0.0.0, wait for one minute and try printing it again.
- You can find your machine's settings, such as the IP address, subnet mask, node name, and MAC Address on the report, for example:
  - IP address: 192.168.0.5
  - Subnet mask: 255.255.255.0
  - Node name: BRN000ca0000499
  - MAC Address: 00-0c-a0-00-04-99

1. Press  [Settings] > [All Settings] > [Print Reports] > [Network Configuration].



If your machine displays the [All Settings] menu on the Home screen, skip the [Settings] menu.

2. Press [Yes].
3. Press .



### Related Information

- [Network Features](#)

#### Related Topics:

- [Check Your Machine's Network Settings](#)
- [Use the Network Connection Repair Tool \(Windows\)](#)
- [Error Messages](#)
- [I Want to Check that My Network Devices are Working Correctly](#)
- [Access Web Based Management](#)
- [Configure the Gigabit Ethernet Settings Using Web Based Management](#)

## Fax Using the Internet (I-Fax)

With Internet Fax (I-Fax), you can send and receive fax documents using the Internet. Documents are transmitted in email messages as attached TIFF-F files. Your computer can send and receive documents as long as it has an application that can create and view TIFF-F files. You can use any TIFF-F viewer application. Documents sent via the machine will be converted into a TIFF-F format automatically. To send and receive messages to and from your machine, your computer's email application must support Multipurpose Internet Mail Extensions (MIME).

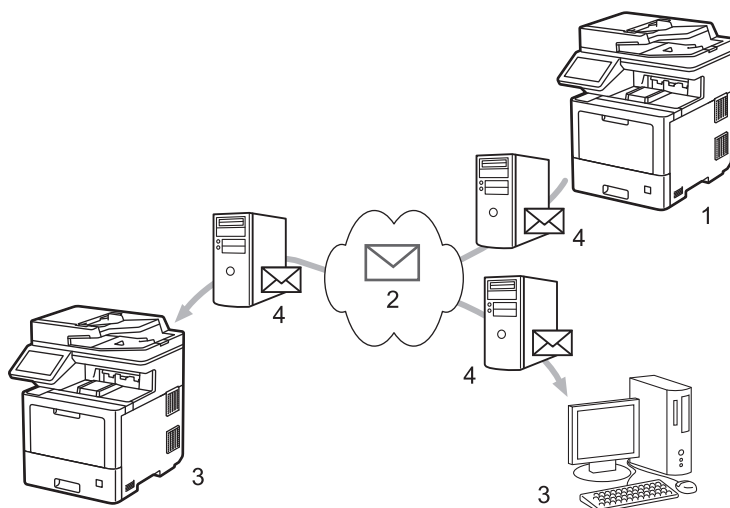

1. Sender
2. Internet
3. Receiver
4. Email server



I-Fax supports sending and receiving documents in Letter or A4 format and in monochrome only.



### Related Information

- [Network Features](#)
  - [Important Information about Internet Fax \(I-Fax\)](#)
  - [Configure the Brother Machine for Email or Internet Fax \(I-Fax\)](#)
  - [Send an Internet Fax \(I-Fax\)](#)
  - [Poll the Server Manually](#)
  - [I-Fax Options](#)

### Related Topics:

- [Forward Received Email and Fax Messages](#)

## Important Information about Internet Fax (I-Fax)

I-Fax communication on a LAN is very similar to communication via email; however, it is different from fax communication using standard phone lines. Make sure you read the following information about using I-Fax:

- Factors such as the receiver's location, structure of the LAN and how busy the circuit (such as the Internet) is may cause the system to take a longer time than usual to send an error mail.
- When sending confidential documents, we recommend using standard phone lines instead of the Internet (due to its low level of security).
- If the receiver's mail system is not MIME-compatible, you cannot use I-Fax to send documents. If possible, check this in advance, and note that some servers will not send an error reply.
- If a document is too large to send via I-Fax, it may not reach the receiver.
- You cannot change the font or size of the text in any Internet mail you receive.



### Related Information

- [Fax Using the Internet \(I-Fax\)](#)

## Configure the Brother Machine for Email or Internet Fax (I-Fax)

Before using I-Fax, configure your Brother machine to communicate with your network and mail server. You can configure these items using the machine's control panel or Web Based Management. Make sure the following items are configured on your machine:

- IP address (If you are already using your machine on your network, the machine's IP address has been configured correctly.)
- Email address
- SMTP, POP3, IMAP4 server address/port/Authentication method/Encryption method/Server Certificate Verification
- Mailbox name and password

If you are unsure of any of these items, contact your system administrator.



### Related Information

- [Fax Using the Internet \(I-Fax\)](#)
  - [Initial Setup for Email or Internet Fax \(I-Fax\)](#)
  - [How Received I-Faxes Appear on a Computer](#)

### Related Topics:

- [I-Fax Options](#)

## Initial Setup for Email or Internet Fax (I-Fax)

Before sending your I-Fax, use the control panel or Web Based Management to configure the following optional items:

- E-mail Subject
- E-mail Message
- Size Limit
- Request Delivery Notification (Send)

### E-mail Send

#### E-mail Subject

Internet Fax Job

#### E-mail Message

Image data has been attached.

#### Size Limit

- Off  
 On

#### Maximum Size

1 MB

#### Request Delivery Notification (Send)

- Off  
 On

[POP3/IMAP4/SMTP Client>>](#)

Cancel

Submit

If you are unsure of any of these items, contact your system administrator.

### ✓ Related Information

- [Configure the Brother Machine for Email or Internet Fax \(I-Fax\)](#)
  - [How Your Brother Machine Receives an Internet Fax \(I-Fax\)](#)

---

**Related Topics:**

- [Forward Received Email and Fax Messages](#)
-

## How Your Brother Machine Receives an Internet Fax (I-Fax)

When your Brother machine receives an incoming I-Fax, it will print the I-Fax automatically. To receive an I-Fax, we recommend using the control panel or Web Based Management to configure the following optional items:

- **Auto Polling**
- **Polling Frequency**
- **Print Mail Header**
- **Delete/Read Receive Error Mail**
- **Send Delivery Notification (Receive)**

### E-mail Receive

#### Auto Polling

- Off  
 On

#### Polling Frequency

10 Mins

#### Print Mail Header

None

#### Delete/Read Receive Error Mail

- Off  
 On

#### Send Delivery Notification (Receive)

Off

[POP3/IMAP4/SMTP Client>>](#)

There are two ways you can receive email messages:

- POP3/IMAP4 receiving at regular intervals
- POP3/IMAP4 receiving, manually initiated

---

When using POP3/IMAP4 receiving, the machine polls your email server to receive data. Polling can occur at set intervals (for example, you can configure the machine to poll the email server every ten minutes) or you can manually poll the server.



- If your machine starts to receive email data, the LCD displays [Receiving]. The email will be printed automatically.
  - If your machine is out of paper when receiving data, the received data will be held in the machine's memory. This data will be printed automatically after paper is reloaded in the paper tray.
  - When the machine's Temporary Fax Backup Function is turned on, received data will be stored for a certain period of time.
  - If the received mail is not in a plain text format, or an attached file is not in the TIFF-F format, the error message "**ATTACHED FILE FORMAT NOT SUPPORTED.**" will be printed.
  - If the received mail is too large, the error message "**E-MAIL FILE TOO LARGE.**" will be printed.
  - If **Delete/Read Receive Error Mail** is **On** (default), then the error mail will be deleted from the email server automatically.
- 



### Related Information

- [Initial Setup for Email or Internet Fax \(I-Fax\)](#)

#### Related Topics:

- [How Received I-Faxes Appear on a Computer](#)
  - [Forward Received Email and Fax Messages](#)
-



## How Received I-Faxes Appear on a Computer

When a computer receives an I-Fax document, the document is attached to an email message that notifies you in its Subject: line that your email server has received an I-Fax. You can either wait for your Brother machine to poll the email server, or you can manually poll the email server to receive the incoming data.



### Related Information

- [Configure the Brother Machine for Email or Internet Fax \(I-Fax\)](#)

### Related Topics:

- [How Your Brother Machine Receives an Internet Fax \(I-Fax\)](#)
-

## Send an Internet Fax (I-Fax)

Sending an I-Fax is like sending a normal fax. Make sure that your recipient's information is saved in your email address book, and load the document you want to I-Fax into your Brother machine.





- If the computer to which you want to send a document is not running Windows Server 2008/2012/2012 R2/2016/2019, Windows 7, Windows 8.1, or Windows 10, ask the computer's owner to install software that can view TIFF files.
- To send multiple pages, use the ADF.

1. Load your document.
2. Do one of the following:
  - If Fax Preview is set to [Off], press [Fax].
  - If Fax Preview is set to [On], press [Fax], and then press [Sending Faxes].
3. To change the fax-sending settings, press [Options].
4. Swipe up or down or press ▲ or ▼ to scroll through the fax settings. When the setting you want appears, press it and select your preference. When you have finished changing settings, press [OK]. (If the [OK] button is displayed.)



If the [OK] button does not appear after setting the time, press  to return to the fax sending screen.

5. Do one of the following:
  - Press , and then enter the email address using the touchscreen. Press [OK].
  - Press [Address Book], select the email address of your recipient, and then press [Apply].
6. Press [Fax Start].

The machine starts scanning. After the document is scanned, it is transmitted to the recipient via your SMTP server. You can cancel the send operation by pressing  during scanning.
7. Press .



### Related Information

- [Fax Using the Internet \(I-Fax\)](#)

## Poll the Server Manually

1. Press  [Settings] > [All Settings] > [Network] > [E-mail/IFAX] > [Manual Receive].



If your machine displays the [All Settings] menu on the Home screen, skip the [Settings] menu.

2. Press [Yes] to confirm.
3. The LCD displays [Receiving] and your machine will print the data from the email server.



### Related Information

- [Fax Using the Internet \(I-Fax\)](#)

## I-Fax Options

- [Forward Received Email and Fax Messages](#)
- [Relay Broadcast](#)
- [Internet Fax \(I-Fax\) Verification Mail](#)
- [Configure the Brother Machine for Email or Internet Fax \(I-Fax\)](#)

## Forward Received Email and Fax Messages

Use Brother's I-Fax feature to forward email or standard fax messages to another computer, to a fax machine, or to another I-Fax machine. Enable the Forwarding feature using your machine's control panel.

To enable email forwarding using your machine's control panel:

1. Press  [Settings] > [All Settings] > [Fax] > [Setup Receive] > [Memory Receive] > [Fax Forward].



If your machine displays the [All Settings] menu on the Home screen, skip the [Settings] menu.

2. Do one of the following:
  - Press [Manual] to enter the forwarding fax number (up to 20 digits) or email address using the LCD. Press [OK].
  - Press [Address Book].  
Swipe up or down or press ▲ or ▼ to scroll until you find the fax number or email address where you want your faxes to be forwarded.  
Press the fax number or email address you want.
3. If you select the email address, select the file type you want.



Press [Backup Print: On] to print received faxes at your machine so you will have a copy.

4. Press .



### Related Information

- [I-Fax Options](#)

#### Related Topics:

- [Fax Using the Internet \(I-Fax\)](#)
- [Initial Setup for Email or Internet Fax \(I-Fax\)](#)
- [How Your Brother Machine Receives an Internet Fax \(I-Fax\)](#)

## Relay Broadcast

A Relay Broadcast is when your Brother machine receives a message over the Internet and then relays it to another fax machine using conventional telephone lines. If you must fax a document over a long distance or abroad, use the Relay Broadcast Function to save the communication fee.

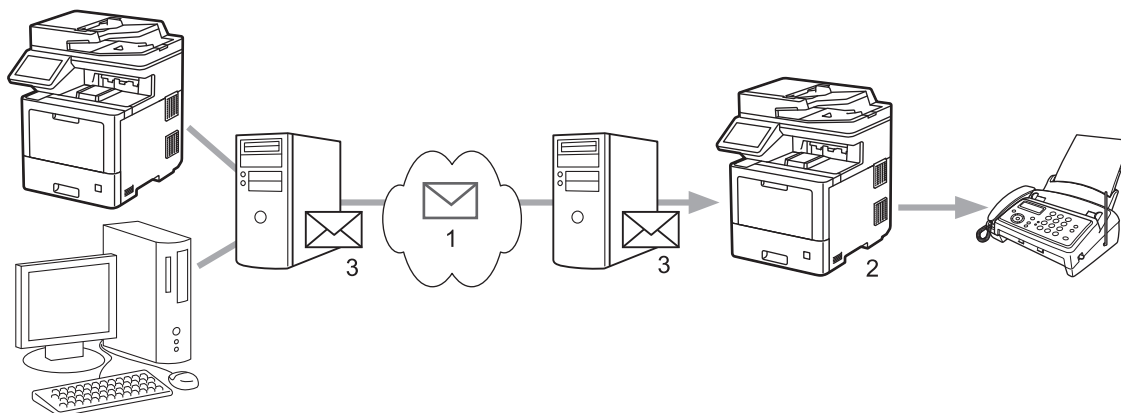

1. The Internet
2. Telephone line
3. Email server

Use the Brother machine's control panel or Web Based Management to configure the following items:

- **Relay Broadcast Function**

Set the **Relay Broadcast Function** to **On**.

- **Relay Domain**

Configure your machine's domain name on the machine that will broadcast the document to the conventional fax machine. If you wish to use your machine as a relay broadcast device, you must specify the trusted domain name (the portion of the name after the "@" sign) at the machine. Use care in selecting a trusted domain: any user on a trusted domain will be able to send a relay broadcast. You can register up to ten domain names.

- **Relay Broadcast Report**

Specify whether or not you want a report to print after the machine completes the relay broadcast.

---

## Relay Function

---

### Relay Broadcast Function

- Off  
 On
- 

### Relay Domain

---

### Relay Broadcast Report

- Off  
 On
- 

Cancel

Submit

---



## Related Information

- [I-Fax Options](#)
    - [Relay Broadcast from Your Brother Machine](#)
    - [Relay Broadcast from Your Computer](#)
-

## Relay Broadcast from Your Brother Machine

Use the Relay Broadcast Function to send email from your machine to a conventional fax machine.

Confirm the **POP3/IMAP4/SMTP Client** and **SMTP Server** checkboxes are selected in Web Based Management. Click **Submit**, and then click **Yes** to restart your machine.

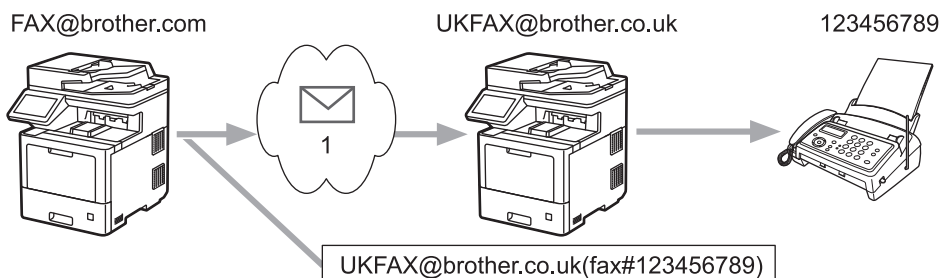

### 1. The Internet

In this example, your machine's email address is FAX@brother.com and you want to send a document from your machine to a standard fax machine in England with the email address UKFAX@brother.co.uk, and you want your machine to send the document using a conventional telephone line.

1. Load your document.
2. Do one of the following:
  - If Fax Preview is set to [Off], press [Fax].
  - If Fax Preview is set to [On], press [Fax], and then press [Sending Faxes].
3. Press [Options].
4. Swipe up or down or press ▲ or ▼ to display the [Broadcasting] option.
5. Press [Broadcasting].
6. Press [Add Number].
7. You can add email addresses to the broadcast in the following ways:
  - Press [Add Number] and press , enter the email address and press [OK].
  - Press [Add from Address book]. Press the checkbox of the email address you want to add to the broadcast. After you have selected all the email addresses you want, press [OK].
  - Press [Search in Address book]. Enter the name and press [OK]. The search results appear. Press the name, and then press the email address you want to add to the broadcast.

The following is an example of how to enter the email address and phone number:

UKFAX@brother.co.uk(fax#123456789)



email address                      Fax Phone Number

The word "fax#" must be included with the phone number inside the parenthesis.

After you have entered all of the fax numbers, press [OK].





If your machine displays , press , and then press .

8. Press [Fax Start].



### Related Information

- [Relay Broadcast](#)
-

## Relay Broadcast from Your Computer

Use the Relay Broadcast Function to send an email from your computer to a conventional fax machine.

- Some email applications do not support sending an email to multiple fax numbers. If your email application cannot support multiple fax numbers, you can relay to only one fax machine at a time.

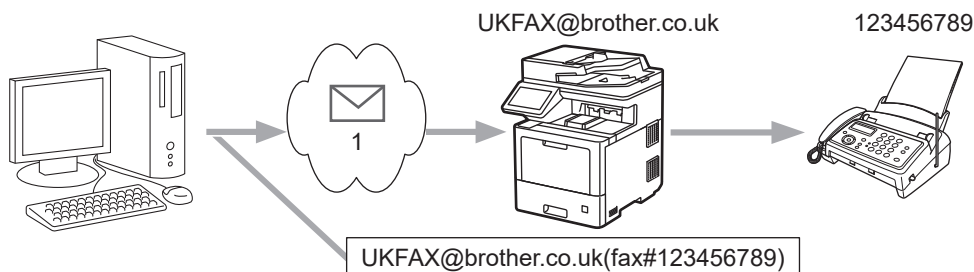

### 1. The Internet

- Confirm the **POP3/IMAP4/SMTP Client** and **SMTP Server** checkboxes are selected in Web Based Management. Click **Submit**, and then click **Yes** to restart your machine.

If you are sending an email to a conventional fax machine, the method of entering the fax machine's fax number will vary, depending on the mail application you are using.

- In your email application, create a new email message and type the email address of the relay machine and fax number of the first fax machine in the "TO" box.

The following is an example of how to enter the email address and fax number:

UKFAX@brother.co.uk(fax#123456789)

email address                      Fax Phone Number

The word "fax#" must be included with the phone number inside the parenthesis.



For Microsoft Outlook, the address information must be entered into the address book as follows:

Name: fax#123456789

Email address: UKFAX@brother.co.uk

- Type the email address of the relay machine and fax number of the second fax machine in the "TO" box.
- Send the email.



### Related Information

- [Relay Broadcast](#)

## Internet Fax (I-Fax) Verification Mail

- Verification Mail for sending allows you to request notification from the receiving station where your I-Fax or email was received and processed.
- Verification Mail for receiving allows you to transmit a default report back to the sending station after successfully receiving and processing an I-Fax or email.

To use this feature, set the [Notification] options in the [Setup Mail RX] and [Setup Mail TX] options of your machine's control panel menu.



### Related Information

- [I-Fax Options](#)
  - [Enable Send Notifications for TX Verification Mail](#)
  - [Enable Receive Notification for TX Verification Mail](#)
  - [I-Fax Error Mail](#)

## Enable Send Notifications for TX Verification Mail

1. Press  [Settings] > [All Settings] > [Network] > [E-mail/IFAX] > [Setup Mail TX] > [Notification].



If your machine displays the [All Settings] menu on the Home screen, skip the [Settings] menu.

2. Select [On] or [Off] to enable or disable the Send Notification feature.

When Send Notification is On, the fax includes an additional field, named Message Disposition Notification (MDN), that contains message delivery information. By default, Send Notification is set to Off.



Your fax recipient's machine must support the MDN field in order to send a notification report.

3. Press .



### Related Information

- [Internet Fax \(I-Fax\) Verification Mail](#)

## Enable Receive Notification for TX Verification Mail

1. Press  [Settings] > [All Settings] > [Network] > [E-mail/IFAX] > [Setup Mail RX] > [Notification].



If your machine displays the [All Settings] menu on the Home screen, skip the [Settings] menu.

2. Press one of the three possible settings:

| Option                   | Description  |
|--------------------------|--|
| Receive Notification On  | When Receive Notification is On, a template is sent back to the sender to indicate successful reception and processing of the message.<br>These templates depend on the operation requested by the sender.<br>Example:<br>SUCCESS : Received From <Mail Address> |
| Receive Notification MDN | When Receive Notification is MDN, a report to indicate successful reception and processing is sent back to the sender if the originating station sent a request confirmation to the MDN (Message Disposition Notification) field.                                |
| Receive Notification Off | When Receive Notification is Off, all forms of receive notification are disabled and no message is sent back to the sender regardless of the request.  |



- To send TX Verification Mail, the Sender must configure these settings:
  - Switch [Notification] in [Setup Mail TX] to [On].
  - Switch [Header] in [Setup Mail RX] to [All] or [Subject+From+To].
- To receive TX Verification Mail, the Receiver must configure these settings:  
Switch [Notification] in [Setup Mail RX] to [On].

3. Press .



### Related Information

- [Internet Fax \(I-Fax\) Verification Mail](#)

## I-Fax Error Mail

If there is a delivery error while sending an I-Fax, the mail server will send an error message back to the Brother machine and the error message will be printed.

If there is an error while receiving an I-Fax, an error message will be printed, for example, "The message being sent to the machine was not in a TIFF format."

To receive the error mail and have it print on your machine, in [Setup Mail RX], switch the [Header] option to [All] or to [Subject+From+To].



### Related Information

- [Internet Fax \(I-Fax\) Verification Mail](#)
-

## Use the Send Fax to Server Feature

The Fax to Server feature allows the machine to scan a document and send it over the network to a separate fax server. The document will then be sent from the server as fax data to the destination fax number over standard phone lines. When the Fax to Server feature is set to On, all automatic fax transmissions from the machine will be sent to the fax server for fax transmission.

You can send a fax directly from the machine using the manual fax feature when the Send to Server feature is on.



### Related Information

- [Network Features](#)
    - [Before Sending a Fax to the Fax Server](#)
    - [Enable Fax to Server](#)
    - [Operate Fax to Server](#)
-





## Enable Fax to Server

Store the prefix/suffix address for the fax server in your Brother machine.

1. Press  [Settings] > [All Settings] > [Network] > [Fax to Server].



If your machine displays the [All Settings] menu on the Home screen, skip the [Settings] menu.

2. Press [Fax to Server].
3. Press [On].
4. Press [Prefix].
5. Enter the prefix using the touchscreen, and then press [OK].
6. Press [Suffix].
7. Enter the suffix using the touchscreen, and then press [OK].
8. Press .



### Related Information

- [Use the Send Fax to Server Feature](#)

## Operate Fax to Server

1. Place the document in the ADF or on the scanner glass.
2. Do one of the following:
  - If Fax Preview is set to [Off], press [Fax].
  - If Fax Preview is set to [On], press [Fax], and then press [Sending Faxes].
3. Enter the fax number.
4. Press [Fax Start].

The machine will send the message over a TCP/IP network to the fax server.



### Related Information

- [Use the Send Fax to Server Feature](#)

## Configure and Operate LDAP Search

MFC-L9630CDN/MFC-L9635CDN/MFC-L9670CDN/MFC-EX670: standard

The LDAP feature allows you to search for information, such as fax numbers and email addresses, on your server. When you use the Fax, I-Fax, or Scan to Email server feature, you can use the LDAP search to find fax numbers or email addresses.



- The LDAP feature does not support simplified Chinese, traditional Chinese, or Korean.
- The LDAP feature supports LDAPv3.
- The LDAP feature does not support SSL/TLS.



### Related Information

- [Network Features](#)
  - [Change LDAP Configuration Using Web Based Management](#)
  - [Perform an LDAP Search Using Your Machine's Control Panel](#)

## Change LDAP Configuration Using Web Based Management

Use Web Based Management to configure your LDAP settings in a web browser.

1. Start your web browser.
2. Type "https://machine's IP address" in your browser's address bar (where "machine's IP address" is the machine's IP address).

For example:

https://192.168.1.2

3. If required, type the password in the **Login** field, and then click **Login**.



---

The default password to manage this machine's settings is located on the back of the machine and marked "Pwd".

---

4. Go to the navigation menu, and then click **Network > Network > Protocol**.



---

Start from , if the navigation menu is not shown on the left side of the screen.

---

5. Select the **LDAP** checkbox, and then click **Submit**.
6. Click **Yes** to restart your Brother machine and activate the configuration.
7. On your computer, in Web Based Management, go to the navigation menu, and then click **Address Book > LDAP**.

- **LDAP Search**
- **LDAP Server Address**
- **Port** (The default port number is 389.)
- **Search Root**
- **Authentication**
- **Username**

This selection will be available depending on the authentication method used.

- **Password**

This selection will be available depending on the authentication method used.



- 
- If the LDAP server supports Kerberos authentication, we recommend selecting Kerberos for the Authentication settings. It provides strong authentication between the LDAP server and your machine.
  - You must configure the SNTP protocol (network time server), or you must set the date, time and time zone correctly on the control panel for Kerberos authentication.
- 

- **Kerberos Server Address**

This selection will be available depending on the authentication method used.

- **Timeout for LDAP**
- **Attribute of Name (Search Key)**
- **Attribute of E-mail**
- **Attribute of Fax Number**
- **Optional Attribute ##**

8. When finished, click **Submit**. Make sure the **Status** field reads **OK**.



### Related Information

- [Configure and Operate LDAP Search](#)

---

**Related Topics:**

- [Synchronise Time with the SNTP Server Using Web Based Management](#)
-

## Perform an LDAP Search Using Your Machine's Control Panel

After you configure LDAP settings, you can use the LDAP search feature to find fax numbers or email addresses to use for:

- Sending a Fax
- Sending an Internet Fax (I-Fax)
- Scanning to Email Server



- The LDAP feature supports LDAPv3.
- The LDAP feature does not support SSL/TLS.
- You may need to use Kerberos Authentication or Simple Authentication to connect to your LDAP server, depending on the security policy set by your network administrator.
- You must configure the SNTP protocol (network time server), or you must set the date, time and time zone correctly on the control panel for Kerberos authentication.

1. Press  to search.
2. Enter the initial characters for your search using the LCD.
3. Press [OK].

The LDAP search result will be shown on the LCD; the  icon appears before the fax number (local) or the email (local) address book search results.

If there is no match on the server or the local address book, the LCD displays [Results cannot be found.] for about 60 seconds.

4. Swipe up or down or press ▲ or ▼ to display the name you want.
5. Press the name.  
To view the details of the name, press [Detail].
6. If the result includes more than one fax number or email address, the machine will prompt you to select just one. Press [Apply]. Do one of the following:
  - If you are sending a fax or an I-Fax, press [Fax Start].
  - If you are scanning to the Email Server, load your document, press [Next], and then press [Start].



### Related Information

- [Configure and Operate LDAP Search](#)

#### Related Topics:

- [Synchronise Time with the SNTP Server Using Web Based Management](#)

## Synchronise Time with the SNTP Server Using Web Based Management

The Simple Network Time Protocol (SNTP) is used to synchronise the time used by the machine for authentication with the SNTP time server. (This is not the time displayed on the machine's LCD.) You can automatically or manually synchronise the machine's time with the Coordinated Universal Time (UTC) provided by the SNTP time server.

- [Configure Date and Time Using Web Based Management](#)
- [Configure the SNTP Protocol Using Web Based Management](#)
- [Change LDAP Configuration Using Web Based Management](#)
- [Perform an LDAP Search Using Your Machine's Control Panel](#)

## Configure Date and Time Using Web Based Management

Configure date and time to synchronise the time used by the machine with the SNTP time server.

This feature is not available in some countries.

1. Start your web browser.
2. Type "https://machine's IP address" in your browser's address bar (where "machine's IP address" is the machine's IP address).

For example:

https://192.168.1.2

3. If required, type the password in the **Login** field, and then click **Login**.



The default password to manage this machine's settings is located on the back of the machine and marked "Pwd".

4. Go to the navigation menu, and then click **Administrator > Date&Time**.



Start from , if the navigation menu is not shown on the left side of the screen.

5. Verify the **Time Zone** settings.



Select the time difference between your location and UTC from the **Time Zone** drop-down list. For example, the time zone for Eastern Time in the USA and Canada is UTC-05:00.

6. Select the **Synchronize with SNTP server** checkbox.
7. Click **Submit**.



You can also configure date and time manually.



### Related Information

- [Synchronise Time with the SNTP Server Using Web Based Management](#)



## Configure the SNTP Protocol Using Web Based Management

Configure the SNTP protocol to synchronise the time the machine uses for authentication with the time kept by the SNTP time server.

1. Start your web browser.
2. Type "https://machine's IP address" in your browser's address bar (where "machine's IP address" is the machine's IP address).

For example:

https://192.168.1.2

3. If required, type the password in the **Login** field, and then click **Login**.



The default password to manage this machine's settings is located on the back of the machine and marked "Pwd".

4. Go to the navigation menu, and then click **Network > Network > Protocol**.



Start from , if the navigation menu is not shown on the left side of the screen.

5. Select the **SNTP** checkbox to activate the settings.
6. Click **Submit**.
7. Click **Yes** to restart your Brother machine and activate the configuration.
8. Next to the SNTP checkbox, click **Advanced Settings**.
9. Configure the settings.

| Option   | Description  |
|--|--|
| <b>Status</b>  | Displays whether the SNTP protocol is enabled or disabled.   |
| <b>Synchronization Status</b>  | Confirm the latest synchronisation status.   |
| <b>SNTP Server Method</b>  | Select <b>AUTO</b> or <b>STATIC</b> . <ul style="list-style-type: none"><li>• <b>AUTO</b><br/>If you have a DHCP server in your network, the SNTP server will obtain the address from that server automatically.</li><li>• <b>STATIC</b><br/>Type the address you want to use.</li></ul> |
| <b>Primary SNTP Server Address</b><br><b>Secondary SNTP Server Address</b> | Type the server address (up to 64 characters).<br>The secondary SNTP server address is used as a backup to the primary SNTP server address. If the primary server is unavailable, the machine will contact the secondary SNTP server.  |
| <b>Primary SNTP Server Port</b><br><b>Secondary SNTP Server Port</b>       | Type the port number (1-65535).<br>The secondary SNTP server port is used as a backup to the primary SNTP server port. If the primary port is unavailable, the machine will contact the secondary SNTP port.   |
| <b>Synchronization Interval</b>  | Type the number of hours between server synchronisation attempts (1-168 hours).  |

10. Click **Submit**.



### Related Information

- [Synchronise Time with the SNTP Server Using Web Based Management](#)

## Gigabit Ethernet (Wired Network Only)

Your machine supports 1000BASE-T Gigabit Ethernet. To connect to a 1000BASE-T Gigabit Ethernet Network, you must set the machine's Ethernet link mode to Auto from the machine's control panel or Web Based Management (web browser).



---

Use a Category 5e (or greater) network cable. The machine can automatically negotiate the highest supported network speed, for example: to achieve 1000BASE-T network speeds, all connecting infrastructure, including network switches and cables must also support 1000BASE-T speeds. Otherwise the machine will communicate at either 10BASE-T or 100BASE-TX.

---



### Related Information

- [Network Features](#)
  - [Configure the Gigabit Ethernet Settings Using Web Based Management](#)
-

## Configure the Gigabit Ethernet Settings Using Web Based Management

1. Start your web browser.
2. Type "https://machine's IP address" in your browser's address bar (where "machine's IP address" is the machine's IP address).

For example:

https://192.168.1.2

3. If required, type the password in the **Login** field, and then click **Login**.



The default password to manage this machine's settings is located on the back of the machine and marked "Pwd".

4. Go to the navigation menu, and then click **Network > Wired > Ethernet**.



Start from ☰, if the navigation menu is not shown on the left side of the screen.

5. Select **Auto** from the **Ethernet Mode** drop-down list.
6. Click **Submit**.
7. To enable the settings, click **Yes** to restart your machine.

You can confirm your settings by printing the Network Configuration Report.



### Related Information

- [Gigabit Ethernet \(Wired Network Only\)](#)

#### Related Topics:

- [Print the Network Configuration Report](#)

## Reset the Network Settings to the Factory Settings

You can use your machine's control panel to reset the machine's network settings to its default factory settings. This resets all information, such as the password and IP address.



- This feature restores all network settings to the factory settings.
- You can also reset the print server to its factory settings using Web Based Management.

1. Press  [Settings] > [All Settings] > [Network] > [Network Reset].



If your machine displays the [All Settings] menu on the Home screen, skip the [Settings] menu.

2. [Machine will reboot after resetting. Press [OK] for 2 seconds to confirm.] appears. Press [OK] for two seconds to confirm.

The machine will restart.



### Related Information

- [Network Features](#)

#### Related Topics:

- [Reset Your Machine](#)

## Security

- [Before Using Network Security Features](#)
- [Configure Certificates for Device Security](#)
- [Use SSL/TLS](#)
- [Use SNMPv3](#)
- [Use IPsec](#)
- [Use IEEE 802.1x Authentication for a Wired or a Wireless Network](#)
- [Use Active Directory Authentication](#)
- [Use LDAP Authentication](#)
- [Use Secure Function Lock 3.0](#)
- [Send or Receive an Email Securely](#)
- [Store Print Log to Network](#)
- [Lock the Machine Settings from the Control Panel](#)

## Before Using Network Security Features

Your machine employs some of the latest network security and encryption protocols available today. These network features can be integrated into your overall network security plan to help protect your data and prevent unauthorised access to the machine.



---

We recommend disabling the Telnet, FTP server, and TFTP protocols. Accessing the machine using these protocols is not secure.

---



### Related Information

- [Security](#)
-

## Configure Certificates for Device Security

You must configure a certificate to manage your networked machine securely using SSL/TLS. You must use Web Based Management to configure a certificate.

- [Supported Security Certificate Features](#)
- [Step by Step Guide for Creating and Installing a Certificate](#)
- [Create a Self-signed Certificate](#)
- [Create CSR and Install a Certificate from a Certificate Authority \(CA\)](#)
- [Import and Export the Certificate and Private Key](#)
- [Import and Export a CA Certificate](#)
- [Manage Multiple Certificates](#)

## Supported Security Certificate Features

Your machine supports the use of multiple security certificates, which allows secure management, authentication, and communication with the machine. The following security certificate features can be used with the machine:

- SSL/TLS communication
- SSL communication for SMTP/POP3/IMAP4 (only available for certain models)
- IEEE 802.1x authentication
- IPsec

Your machine supports the following:

- Pre-installed certificate

Your machine has a pre-installed self-signed certificate. This certificate enables you to use SSL/TLS communication without creating or installing a different certificate.



---

The pre-installed self-signed certificate protects your communication up to a certain level. We recommend using a certificate that is issued by a trusted organisation for better security.

---

- Self-signed certificate

This print server issues its own certificate. Using this certificate, you can easily use the SSL/TLS communication without creating or installing a different certificate from a CA.

- Certificate from a Certificate Authority (CA)

There are two methods for installing a certificate from a CA. If you already have a certificate from a CA or if you want to use a certificate from an external trusted CA:

- When using a Certificate Signing Request (CSR) from this print server.
- When importing a certificate and a private key.

- Certificate Authority (CA) Certificate

To use a CA certificate that identifies the CA and owns its private key, you must import that CA certificate from the CA before configuring the security features of the Network.



- If you are going to use SSL/TLS communication, we recommend contacting your system administrator first.
  - When you reset the print server back to its default factory settings, the certificate and the private key that are installed will be deleted. If you want to keep the same certificate and the private key after resetting the print server, export them before resetting, and then reinstall them.
- 



### Related Information

- [Configure Certificates for Device Security](#)
-



## Step by Step Guide for Creating and Installing a Certificate

There are two options when choosing a security certificate: use a self-signed certificate or use a certificate from a Certificate Authority (CA).

### Option 1

#### Self-Signed Certificate

1. Create a self-signed certificate using Web Based Management.
2. Install the self-signed certificate on your computer.

### Option 2

#### Certificate from a CA

1. Create a Certificate Signing Request (CSR) using Web Based Management.
2. Install the certificate issued by the CA on your Brother machine using Web Based Management.
3. Install the certificate on your computer.



#### Related Information

- [Configure Certificates for Device Security](#)

## Create a Self-signed Certificate

1. Start your web browser.
2. Type "https://machine's IP address" in your browser's address bar (where "machine's IP address" is the machine's IP address).

For example:

https://192.168.1.2



If you are using a Domain Name System or enable a NetBIOS name, you can type another name, such as "SharedPrinter" instead of the IP address.

For example:

https://SharedPrinter

If you enable a NetBIOS name, you can also use the node name.

For example:

https://brnxxxxxxxxxxxx

The NetBIOS name can be found in the Network Configuration Report.

3. If required, type the password in the **Login** field, and then click **Login**.



The default password to manage this machine's settings is located on the back of the machine and marked "Pwd".

4. Go to the navigation menu, and then click **Network > Security > Certificate**.



Start from , if the navigation menu is not shown on the left side of the screen.

5. Click **Create Self-Signed Certificate**.
6. Enter a **Common Name** and a **Valid Date**.
  - The length of the **Common Name** is less than 64 bytes. Enter an identifier, such as an IP address, node name, or domain name to use when accessing this machine through SSL/TLS communication. The node name is displayed by default.
  - A warning will appear if you use the IPPS or HTTPS protocol and enter a different name in the URL than the **Common Name** that was used for the self-signed certificate.
7. Select your setting from the **Public Key Algorithm** drop-down list. The default setting is **RSA(2048bit)**.
8. Select your setting from the **Digest Algorithm** drop-down list. The default setting is **SHA256**.
9. Click **Submit**.



### Related Information

- [Configure Certificates for Device Security](#)

## Create CSR and Install a Certificate from a Certificate Authority (CA)

If you already have a certificate from an external trusted CA, you can store the certificate and private key on the machine and manage them by importing and exporting. If you do not have a certificate from an external trusted CA, create a Certificate Signing Request (CSR), send it to a CA for authentication, and install the returned certificate on your machine.

- [Create a Certificate Signing Request \(CSR\)](#)
- [Install a Certificate on Your Machine](#)

## Create a Certificate Signing Request (CSR)

A Certificate Signing Request (CSR) is a request sent to a Certificate Authority (CA) to authenticate the credentials contained within the certificate.

We recommend installing a Root Certificate from the CA on your computer before creating the CSR.

1. Start your web browser.
2. Type "https://machine's IP address" in your browser's address bar (where "machine's IP address" is the machine's IP address).

For example:

https://192.168.1.2



If you are using a Domain Name System or enable a NetBIOS name, you can type another name, such as "SharedPrinter" instead of the IP address.

For example:

https://SharedPrinter

If you enable a NetBIOS name, you can also use the node name.

For example:

https://brnxxxxxxxxxxxx

The NetBIOS name can be found in the Network Configuration Report.

3. If required, type the password in the **Login** field, and then click **Login**.



The default password to manage this machine's settings is located on the back of the machine and marked "Pwd".

4. Go to the navigation menu, and then click **Network > Security > Certificate**.



Start from ☰, if the navigation menu is not shown on the left side of the screen.

5. Click **Create CSR**.
6. Type a **Common Name** (required) and add other information about your **Organization** (optional).



- Your company details are required so that a CA can confirm your identity and verify it to the outside world.
- The length of the **Common Name** must be less than 64 bytes. Enter an identifier, such as an IP address, node name, or domain name to use when accessing this machine through SSL/TLS communication. The node name is displayed by default. The **Common Name** is required.
- A warning will appear if you type a different name in the URL than the Common Name that was used for the certificate.
- The length of the **Organization**, the **Organization Unit**, the **City/Locality**, and the **State/Province** must be less than 64 bytes.
- The **Country/Region** should be a two-character ISO 3166 country code.
- If you are configuring an X.509v3 certificate extension, select the **Configure extended partition** checkbox, and then select **Auto (Register IPv4)** or **Manual**.

7. Select your setting from the **Public Key Algorithm** drop-down list. The default setting is **RSA(2048bit)**.
8. Select your setting from the **Digest Algorithm** drop-down list. The default setting is **SHA256**.
9. Click **Submit**.

The CSR appears on your screen. Save the CSR as a file or copy and paste it into an online CSR form offered by a Certificate Authority.

---

10. Click **Save**.



- Follow your CA's policy regarding the method to send a CSR to your CA.
  - If you are using the Enterprise root CA of Windows Server 2008/2008 R2/2012/2012 R2/2016/2019, we recommend using the Web Server for the certificate template to securely create the Client Certificate. If you are creating a Client Certificate for an IEEE 802.1x environment with EAP-TLS authentication, we recommend using User for the certificate template.
- 



### **Related Information**

- [Create CSR and Install a Certificate from a Certificate Authority \(CA\)](#)
-

## Install a Certificate on Your Machine

When you receive a certificate from a CA, follow the steps below to install it into the print server:

Only a certificate issued with your machine's CSR can be installed onto the machine. When you want to create another CSR, make sure that the certificate is installed before creating another CSR. Create another CSR only after installing the certificate on the machine. Otherwise, the CSR you create before installing will be invalid.

1. Start your web browser.
2. Type "https://machine's IP address" in your browser's address bar (where "machine's IP address" is the machine's IP address).

For example:

https://192.168.1.2



If you are using a Domain Name System or enable a NetBIOS name, you can type another name, such as "SharedPrinter" instead of the IP address.

For example:

https://SharedPrinter

If you enable a NetBIOS name, you can also use the node name.

For example:

https://brnxxxxxxxxxxxx

The NetBIOS name can be found in the Network Configuration Report.

3. If required, type the password in the **Login** field, and then click **Login**.



The default password to manage this machine's settings is located on the back of the machine and marked "Pwd".

4. Go to the navigation menu, and then click **Network > Security > Certificate**.



Start from ☰, if the navigation menu is not shown on the left side of the screen.

5. Click **Install Certificate**.
6. Browse to the file that contains the certificate issued by the CA, and then click **Submit**.

The certificate has been created and saved in your machine's memory successfully.

To use SSL/TLS communication, the Root Certificate from the CA must be installed on your computer. Contact your network administrator.



### Related Information

- [Create CSR and Install a Certificate from a Certificate Authority \(CA\)](#)

## Import and Export the Certificate and Private Key

Store the certificate and private key on your machine and manage them by importing and exporting them.

- [Import a Certificate and Private Key](#)
- [Export the Certificate and Private Key](#)

## Import a Certificate and Private Key

1. Start your web browser.
2. Type "https://machine's IP address" in your browser's address bar (where "machine's IP address" is the machine's IP address).

For example:

https://192.168.1.2



If you are using a Domain Name System or enable a NetBIOS name, you can type another name, such as "SharedPrinter" instead of the IP address.

For example:

https://SharedPrinter

If you enable a NetBIOS name, you can also use the node name.

For example:

https://brnxxxxxxxxxxxx

The NetBIOS name can be found in the Network Configuration Report.

3. If required, type the password in the **Login** field, and then click **Login**.



The default password to manage this machine's settings is located on the back of the machine and marked "Pwd".

4. Go to the navigation menu, and then click **Network > Security > Certificate**.



Start from , if the navigation menu is not shown on the left side of the screen.

5. Click **Import Certificate and Private Key**.
6. Browse to the file you want to import.
7. Type the password if the file is encrypted, and then click **Submit**.

The certificate and private key are imported to your machine.



### Related Information

- [Import and Export the Certificate and Private Key](#)



## Export the Certificate and Private Key

1. Start your web browser.
2. Type "https://machine's IP address" in your browser's address bar (where "machine's IP address" is the machine's IP address).

For example:

https://192.168.1.2



If you are using a Domain Name System or enable a NetBIOS name, you can type another name, such as "SharedPrinter" instead of the IP address.

For example:

https://SharedPrinter

If you enable a NetBIOS name, you can also use the node name.

For example:

https://brnxxxxxxxxxxxx

The NetBIOS name can be found in the Network Configuration Report.

3. If required, type the password in the **Login** field, and then click **Login**.



The default password to manage this machine's settings is located on the back of the machine and marked "Pwd".

4. Go to the navigation menu, and then click **Network > Security > Certificate**.



Start from , if the navigation menu is not shown on the left side of the screen.

5. Click **Export** shown with **Certificate List**.
6. Enter the password if you want to encrypt the file.  
If a blank password is used, the output is not encrypted.
7. Enter the password again for confirmation, and then click **Submit**.
8. Click **Save**.

The certificate and private key are exported to your computer.

You can also import the certificate to your computer.



### Related Information

- [Import and Export the Certificate and Private Key](#)

## Import and Export a CA Certificate

You can import, export, and store CA certificates on your Brother machine.

- [Import a CA Certificate](#)
- [Export a CA Certificate](#)

## Import a CA Certificate

1. Start your web browser.
2. Type "https://machine's IP address" in your browser's address bar (where "machine's IP address" is the machine's IP address).

For example:

https://192.168.1.2



If you are using a Domain Name System or enable a NetBIOS name, you can type another name, such as "SharedPrinter" instead of the IP address.

For example:

https://SharedPrinter

If you enable a NetBIOS name, you can also use the node name.

For example:

https://brnxxxxxxxxxxxx

The NetBIOS name can be found in the Network Configuration Report.

3. If required, type the password in the **Login** field, and then click **Login**.



The default password to manage this machine's settings is located on the back of the machine and marked "Pwd".

4. Go to the navigation menu, and then click **Network > Security > CA Certificate**.



Start from , if the navigation menu is not shown on the left side of the screen.

5. Click **Import CA Certificate**.
6. Browse to the file you want to import.
7. Click **Submit**.



### Related Information

- [Import and Export a CA Certificate](#)

## Export a CA Certificate

1. Start your web browser.
2. Type "https://machine's IP address" in your browser's address bar (where "machine's IP address" is the machine's IP address).

For example:

https://192.168.1.2



If you are using a Domain Name System or enable a NetBIOS name, you can type another name, such as "SharedPrinter" instead of the IP address.

For example:

https://SharedPrinter

If you enable a NetBIOS name, you can also use the node name.

For example:

https://brnxxxxxxxxxxxx

The NetBIOS name can be found in the Network Configuration Report.

3. If required, type the password in the **Login** field, and then click **Login**.



The default password to manage this machine's settings is located on the back of the machine and marked "Pwd".

4. Go to the navigation menu, and then click **Network > Security > CA Certificate**.



Start from ☰, if the navigation menu is not shown on the left side of the screen.

5. Select the certificate you want to export and click **Export**.
6. Click **Submit**.
7. Click ▼ next to **Save**, and then specify the location where you want to save the file.



### Related Information

- [Import and Export a CA Certificate](#)

## Manage Multiple Certificates

The multiple certificate feature allows you to use Web Based Management to manage each certificate installed on your machine. In Web Based Management, navigate to the **Certificate** or **CA Certificate** screen to view certificate content, delete, or export your certificates.

|   | Maximum Number of Certificates Stored on Brother Machine |
|---|--|
| Self-signed Certificate or Certificate Issued by a CA | 6  |
| CA Certificate  | 9  |

We recommend storing fewer certificates than allowed, reserving an empty spot in case of certificate expiration. When a certificate expires, import a new certificate into the reserved spot, and then delete the expired certificate. This ensures that you avoid configuration failure.



- When you use HTTPS/IPPS, IEEE 802.1x, or Signed PDF, you must select which certificate you are using.
- When you use SSL for SMTP/POP3/IMAP4 communications (only available for certain models), you do not have to choose the certificate. The necessary certificate will be chosen automatically.



### Related Information

- [Configure Certificates for Device Security](#)

## Use SSL/TLS

- [Introduction to SSL/TLS](#)
- [Manage Your Network Machine Securely Using SSL/TLS](#)
- [Print Documents Securely Using SSL/TLS](#)
- [Send or Receive an Email Securely](#)

## Introduction to SSL/TLS

Secure Socket Layer (SSL) or Transport Layer Security (TLS) is an effective method of protecting data sent over a local or wide area network (LAN or WAN). It works by encrypting data, such as a print job, sent over a network, so anyone trying to capture it will not be able to read it.

SSL/TLS can be configured on both wired and wireless networks and will work with other forms of security such as WPA keys and firewalls.



### Related Information

- [Use SSL/TLS](#)
  - [Brief History of SSL/TLS](#)
  - [Benefits of Using SSL/TLS](#)

## Brief History of SSL/TLS

SSL/TLS was originally created to secure web traffic information, particularly data sent between web browsers and servers. For example, when you use Internet Explorer for Internet Banking and you see https:// and the little padlock icon in the web browser, you are using SSL. SSL grew to work with additional applications, such as Telnet, printer, and FTP software, in order to become a universal solution for online security. Its original design intentions are still being used today by many online retailers and banks to secure sensitive data, such as credit card numbers, customer records, etc.

SSL/TLS uses extremely high levels of encryption and is trusted by banks all over the world.



### Related Information

- [Introduction to SSL/TLS](#)
-



## Benefits of Using SSL/TLS

The primary benefit of using SSL/TLS is to guarantee secure printing over an IP network by restricting unauthorised users from reading data sent to the machine. SSL's key selling point is that it can be used to print confidential data securely. For example, an HR department in a large company may be printing wage slips on a regular basis. Without encryption, the data contained on these wages slips can be read by other network users. However, with SSL/TLS, anyone trying to capture the data will see a confusing page of code and not the actual wage slip.



### Related Information

- [Introduction to SSL/TLS](#)

## Manage Your Network Machine Securely Using SSL/TLS

- [Configure a Certificate for SSL/TLS and Available Protocols](#)
- [Access Web Based Management Using SSL/TLS](#)
- [Install the Self-signed Certificate for Windows users with Administrator Rights](#)
- [Configure Certificates for Device Security](#)

## Configure a Certificate for SSL/TLS and Available Protocols

Configure a certificate on your machine using Web Based Management before you use SSL/TLS communication.

1. Start your web browser.
2. Type "https://machine's IP address" in your browser's address bar (where "machine's IP address" is the machine's IP address).

For example:

https://192.168.1.2



If you are using a Domain Name System or enable a NetBIOS name, you can type another name, such as "SharedPrinter" instead of the IP address.

For example:

https://SharedPrinter

If you enable a NetBIOS name, you can also use the node name.

For example:

https://brnxxxxxxxxxxxx

The NetBIOS name can be found in the Network Configuration Report.

3. If required, type the password in the **Login** field, and then click **Login**.



The default password to manage this machine's settings is located on the back of the machine and marked "Pwd".

4. Go to the navigation menu, and then click **Network > Network > Protocol**.



Start from ☰, if the navigation menu is not shown on the left side of the screen.

5. Click **HTTP Server Settings**.
6. Select the certificate you want to configure from the **Select the Certificate** drop-down list.
7. Click **Submit**.
8. Click **Yes** to restart your print server.



### Related Information

- [Manage Your Network Machine Securely Using SSL/TLS](#)

## Access Web Based Management Using SSL/TLS

To manage your network machine securely, use Web Based Management with the HTTPS protocol.



- To use HTTPS protocol, HTTPS must be enabled on your machine. The HTTPS protocol is enabled by default.
- You can change the HTTPS protocol settings using the Web Based Management.

1. Start your web browser.
2. Type "https://Common Name" in your browser's address bar (where "Common Name" is the Common Name that you assigned to the certificate; this could be your IP address, node name, or domain name).
3. If required, type the password in the **Login** field, and then click **Login**.



The default password to manage this machine's settings is located on the back of the machine and marked "Pwd".

4. You can now access the machine using HTTPS.



### Related Information

- [Manage Your Network Machine Securely Using SSL/TLS](#)

## Install the Self-signed Certificate for Windows users with Administrator Rights

The following steps are for Microsoft Internet Explorer. If you use another web browser, consult the documentation for your web browser to get help with installing certificates.

1. Do one of the following:
  - Windows 10, Windows Server 2016, and Windows Server 2019  
Click  > **Windows Accessories**.
  - Windows 8.1  
Right-click the  (**Internet Explorer**) icon on the taskbar.
  - Windows Server 2012 and Windows Server 2012 R2  
Click  (**Internet Explorer**), and then right-click the  (**Internet Explorer**) icon that appears on the taskbar.
  - Windows 7 and Windows Server 2008  
Click  (**Start**) > **All Programs**.
2. Right-click **Internet Explorer**, and then click **Run as administrator**.  
 If the **More** option appears, click **More**.  
If the **User Account Control** screen appears, click **Yes**.
3. Type "https://machine's IP address" in your browser's address bar to access your machine (where "machine's IP address" is the machine's IP address or the node name that you assigned for the certificate).
4. Click **More information**.
5. Click **Go on to the webpage (not recommended)**.

6. Click **Certificate error**, and then click **View certificates**.

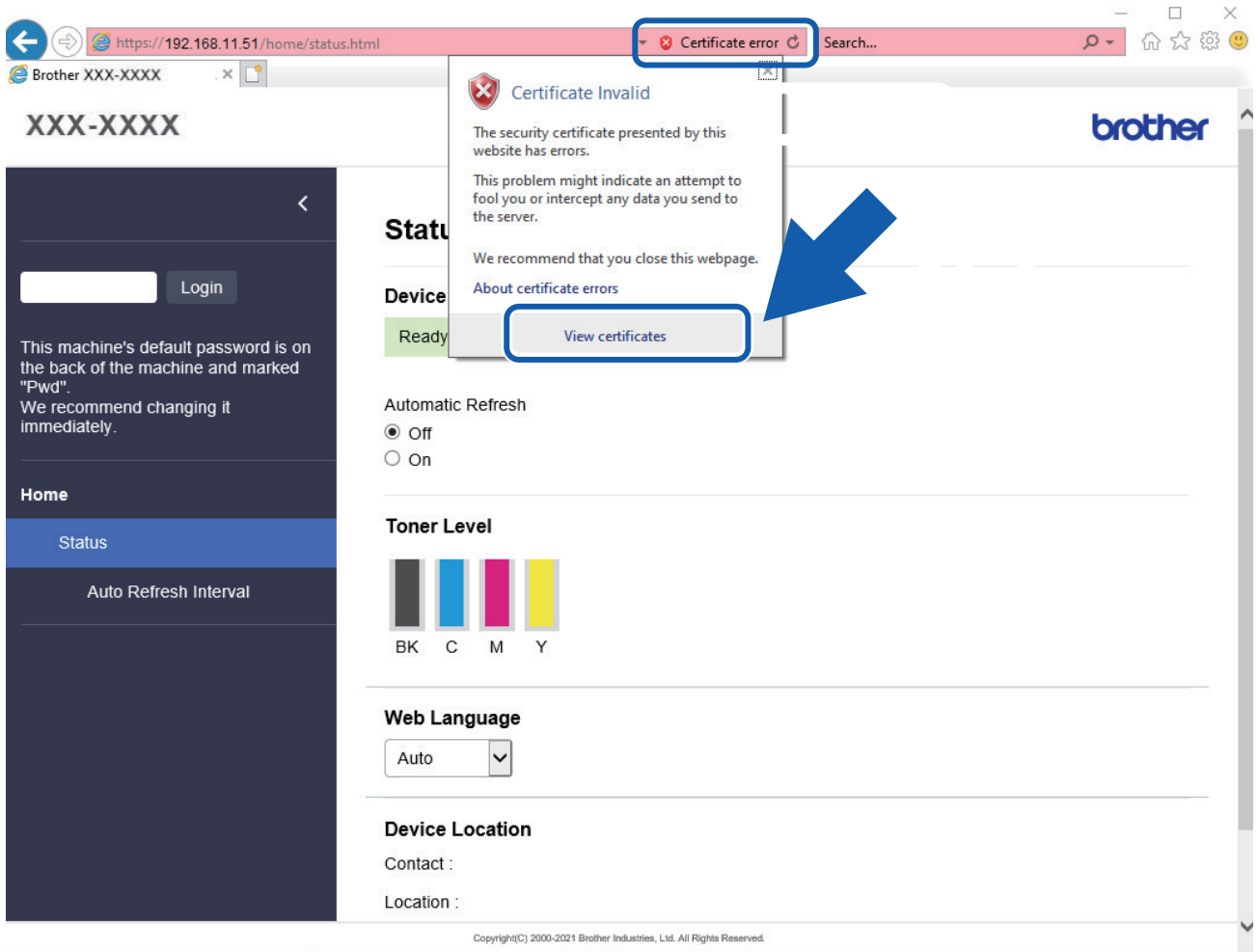

7. Click **Install Certificate...**

8. When the **Certificate Import Wizard** appears, click **Next**.

9. Select **Place all certificates in the following store**, and then click **Browse...**

10. Select **Trusted Root Certification Authorities**, and then click **OK**.

11. Click **Next**.

12. Click **Finish**.

13. Click **Yes**, if the fingerprint (thumbprint) is correct.

14. Click **OK**.



## Related Information

- [Manage Your Network Machine Securely Using SSL/TLS](#)

## Print Documents Securely Using SSL/TLS

- [Print Documents Using SSL/TLS](#)
- [Configure a Certificate for SSL/TLS and Available Protocols](#)
- [Configure Certificates for Device Security](#)

## Print Documents Using SSL/TLS

To print documents securely with IPP protocol, use the IPPS protocol.

1. Start your web browser.
2. Type "https://machine's IP address" in your browser's address bar (where "machine's IP address" is the machine's IP address).

For example:

https://192.168.1.2



If you are using a Domain Name System or enable a NetBIOS name, you can type another name, such as "SharedPrinter" instead of the IP address.

For example:

https://SharedPrinter

If you enable a NetBIOS name, you can also use the node name.

For example:

https://brnxxxxxxxxxxxx

The NetBIOS name can be found in the Network Configuration Report.

3. If required, type the password in the **Login** field, and then click **Login**.



The default password to manage this machine's settings is located on the back of the machine and marked "Pwd".

4. Go to the navigation menu, and then click **Network > Network > Protocol**.



Start from ☰, if the navigation menu is not shown on the left side of the screen.

5. Make sure the **IPP** checkbox is selected.



If the **IPP** checkbox is not selected, select the **IPP** checkbox, and then click **Submit**.

Click **Yes** to restart your machine and activate the configuration.

After the machine restarts, return to the machine's web page, type the password, go to the navigation menu, and then click **Network > Network > Protocol**.

6. Click **HTTP Server Settings**.
7. Select the **HTTPS(Port 443)** checkbox in the **IPP**, and then click **Submit**.
8. Click **Yes** to restart your machine and activate the configuration.

Communication using IPPS cannot prevent unauthorised access to the print server.



### Related Information

- [Print Documents Securely Using SSL/TLS](#)



## Use SNMPv3

- [Manage Your Network Machine Securely Using SNMPv3](#)

## Manage Your Network Machine Securely Using SNMPv3

The Simple Network Management Protocol version 3 (SNMPv3) provides user authentication and data encryption to manage network devices securely.

1. Start your web browser.
2. Type "https://Common Name" in your browser's address bar (where "Common Name" is the Common Name that you assigned to the certificate; this could be your IP address, node name, or domain name).
3. If required, type the password in the **Login** field, and then click **Login**.





The default password to manage this machine's settings is located on the back of the machine and marked "Pwd".

4. Go to the navigation menu, and then click **Network > Network > Protocol**.



Start from , if the navigation menu is not shown on the left side of the screen.

5. Make sure the **SNMP** setting is enabled, and then click **Advanced Settings**.
6. Configure the SNMP settings.

| Option  | Description   |
|---|---|
| <b>SNMP v1/v2c read-write access</b>                        | The print server uses version 1 and version 2c of the SNMP protocol. You can use all of your machine's applications in this mode. However, it is not secure since it will not authenticate the user and data will not be encrypted.   |
| <b>SNMPv3 read-write access and v1/v2c read-only access</b> | <p>The print server uses the read-write access of version 3 and the read-only access of version 1 and version 2c of the SNMP protocol.</p> <p> When you use the <b>SNMPv3 read-write access and v1/v2c read-only access</b> mode, some of your machine's applications that access the print server do not work correctly since they authorize the read-only access of version 1 and version 2c. If you want to use all applications, we recommend using the <b>SNMP v1/v2c read-write access</b> mode.</p> |
| <b>SNMPv3 read-write access</b>                             | <p>The print server uses version 3 of the SNMP protocol. If you want to manage the print server securely, use this mode.</p> <p> When you use the <b>SNMPv3 read-write access</b> mode, note the following: Except for BRAdmin Professional, all applications that use SNMPv1/v2c will be restricted. To allow the use of SNMPv1/v2c applications, use the <b>SNMPv3 read-write access and v1/v2c read-only access</b> or <b>SNMP v1/v2c read-write access</b> mode.</p>                                   |

7. Click **Submit**.



If your machine displays the protocol setting options, select the options you want.

8. Click **Yes** to restart your machine and activate the configuration.



### Related Information

- [Use SNMPv3](#)

## Use IPsec

- [Introduction to IPsec](#)
- [Configure IPsec Using Web Based Management](#)
- [Configure an IPsec Address Template Using Web Based Management](#)
- [Configure an IPsec Template Using Web Based Management](#)

## Introduction to IPsec

IPsec (Internet Protocol Security) is a security protocol that uses an optional Internet Protocol function to prevent data manipulation and ensure the confidentiality of data transmitted as IP packets. IPsec encrypts data carried over the network, such as print data sent from computers to a printer. Because the data is encrypted at the network layer, applications that employ a higher-level protocol use IPsec even if the user is not aware of its use.

IPsec supports the following functions:

- IPsec transmissions

According to the IPsec setting conditions, the network-connected computer sends data to and receives data from the specified device using IPsec. When the devices start communicating using IPsec, keys are exchanged using Internet Key Exchange (IKE) first, and then the encrypted data is transmitted using the keys.

In addition, IPsec has two operation modes: the Transport mode and Tunnel mode. The Transport mode is used mainly for communication between devices and the Tunnel mode is used in environments such as a Virtual Private Network (VPN).



---

For IPsec transmissions, the following conditions are necessary:

- A computer that can communicate using IPsec is connected to the network.
  - Your machine is configured for IPsec communication.
  - The computer connected to your machine is configured for IPsec connections.
- 

- IPsec settings

The settings that are necessary for connections using IPsec. These settings can be configured using Web Based Management.



---

To configure the IPsec settings, you must use the browser on a computer that is connected to the network.

---



### Related Information

- [Use IPsec](#)
-

## Configure IPsec Using Web Based Management

The IPsec connection conditions comprise two **Template** types: **Address** and **IPsec**. You can configure up to 10 connection conditions.

1. Start your web browser.
2. Type "https://machine's IP address" in your browser's address bar (where "machine's IP address" is the machine's IP address).

For example:

https://192.168.1.2

3. If required, type the password in the **Login** field, and then click **Login**.



The default password to manage this machine's settings is located on the back of the machine and marked "Pwd".

4. Go to the navigation menu, and then click **Network > Security > IPsec**.



Start from , if the navigation menu is not shown on the left side of the screen.

5. Configure the settings.

| Option                            | Description   |
|-----------------------------------|---|
| <b>Status</b>                     | Enable or disable IPsec.  |
| <b>Negotiation Mode</b>           | Select <b>Negotiation Mode</b> for IKE Phase 1. IKE is a protocol that is used to exchange encryption keys in order to carry out encrypted communication using IPsec.<br><br>In the <b>Main</b> mode, the processing speed is slow, but the security is high. In the <b>Aggressive</b> mode, the processing speed is faster than in the <b>Main</b> mode, but the security is lower.  |
| <b>All Non-IPsec Traffic</b>      | Select the action to be taken for non-IPsec packets.<br>When using Web Services, you must select <b>Allow</b> for <b>All Non-IPsec Traffic</b> . If you select <b>Drop</b> , Web Services cannot be used.   |
| <b>Broadcast/Multicast Bypass</b> | Select <b>Enabled</b> or <b>Disabled</b> .  |
| <b>Protocol Bypass</b>            | Select the checkboxes for the option or options you want.   |
| <b>Rules</b>                      | Select the <b>Enabled</b> checkbox to activate the template. When you select multiple checkboxes, the lower numbered checkboxes have priority if the settings for the selected checkboxes conflict.<br><br>Click the corresponding drop-down list to select the <b>Address Template</b> that is used for the IPsec connection conditions. To add an <b>Address Template</b> , click <b>Add Template</b> .<br><br>Click the corresponding drop-down list to select the <b>IPsec Template</b> that is used for the IPsec connection conditions. To add an <b>IPsec Template</b> , click <b>Add Template</b> . |

6. Click **Submit**.

If the machine must be restarted to register the new settings, the restart confirmation screen will appear.

If there is a blank item in the template you enabled in the **Rules** table, an error message appears. Confirm your choices and click **Submit** again.



### Related Information

- [Use IPsec](#)

#### Related Topics:

- [Configure Certificates for Device Security](#)

## Configure an IPsec Address Template Using Web Based Management

1. Start your web browser.
2. Type "https://machine's IP address" in your browser's address bar (where "machine's IP address" is the machine's IP address).

For example:

https://192.168.1.2

3. If required, type the password in the **Login** field, and then click **Login**.



The default password to manage this machine's settings is located on the back of the machine and marked "Pwd".

4. Go to the navigation menu, and then click **Network > Security > IPsec Address Template**.



Start from ☰, if the navigation menu is not shown on the left side of the screen.

5. Click the **Delete** button to delete an **Address Template**. When an **Address Template** is in use, it cannot be deleted.
6. Click the **Address Template** that you want to create. The **IPsec Address Template** appears.
7. Configure the settings.

| Option                   | Description  |
|--------------------------|--|
| <b>Template Name</b>     | Type a name for the template (up to 16 characters).  |
| <b>Local IP Address</b>  | <ul style="list-style-type: none"> <li>• <b>IP Address</b><br/>Specify the IP address. Select <b>ALL IPv4 Address</b>, <b>ALL IPv6 Address</b>, <b>ALL Link Local IPv6</b>, or <b>Custom</b> from the drop-down list.<br/>If you select <b>Custom</b> from the drop-down list, type the IP address (IPv4 or IPv6) in the text box.</li> <li>• <b>IP Address Range</b><br/>Type the starting and ending IP addresses for the IP address range in the text boxes. If the starting and ending IP addresses are not standardised to IPv4 or IPv6, or the ending IP address is smaller than the starting address, an error will occur.</li> <li>• <b>IP Address / Prefix</b><br/>Specify the IP address using CIDR notation.<br/>For example: 192.168.1.1/24<br/>Because the prefix is specified in the form of a 24-bit subnet mask (255.255.255.0) for 192.168.1.1, the addresses 192.168.1.xxx are valid.</li> </ul> |
| <b>Remote IP Address</b> | <ul style="list-style-type: none"> <li>• <b>Any</b><br/>If you select <b>Any</b>, all IP addresses are enabled.</li> <li>• <b>IP Address</b><br/>Type the specified IP address (IPv4 or IPv6) in the text box.</li> <li>• <b>IP Address Range</b><br/>Type the starting and ending IP addresses for the IP address range. If the starting and ending IP addresses are not standardised to IPv4 or IPv6, or the ending IP address is smaller than the starting address, an error will occur.</li> <li>• <b>IP Address / Prefix</b><br/>Specify the IP address using CIDR notation.<br/>For example: 192.168.1.1/24</li> </ul>   |

---

| Option | Description   |
|--------|---|
|        | Because the prefix is specified in the form of a 24-bit subnet mask (255.255.255.0) for 192.168.1.1, the addresses 192.168.1.xxx are valid. |

8. Click **Submit**.



---

When you change the settings for the template currently in use, restart your machine to activate the configuration.

---



### Related Information

- [Use IPsec](#)
-

## Configure an IPsec Template Using Web Based Management

1. Start your web browser.
2. Type "https://machine's IP address" in your browser's address bar (where "machine's IP address" is the machine's IP address).

For example:

https://192.168.1.2

3. If required, type the password in the **Login** field, and then click **Login**.



The default password to manage this machine's settings is located on the back of the machine and marked "Pwd".

4. Go to the navigation menu, and then click **Network > Security > IPsec Template**.



Start from ☰, if the navigation menu is not shown on the left side of the screen.

5. Click the **Delete** button to delete an **IPsec Template**. When an **IPsec Template** is in use, it cannot be deleted.
6. Click the **IPsec Template** that you want to create. The **IPsec Template** screen appears. The configuration fields differ based on the **Use Prefixed Template** and **Internet Key Exchange (IKE)** settings you select.
7. In the **Template Name** field, type a name for the template (up to 16 characters).
8. If you selected **Custom** in the **Use Prefixed Template** drop-down list, select the **Internet Key Exchange (IKE)** options, and then change the settings if needed.
9. Click **Submit**.





### Related Information

- [Use IPsec](#)
  - [IKEv1 Settings for an IPsec Template](#)
  - [IKEv2 Settings for an IPsec Template](#)
  - [Manual Settings for an IPsec Template](#)



## IKEv1 Settings for an IPsec Template

| Option                      | Description  |
|-----------------------------|--|
| Template Name               | Type a name for the template (up to 16 characters).  |
| Use Prefixed Template       | Select <b>Custom</b> , <b>IKEv1 High Security</b> or <b>IKEv1 Medium Security</b> . The setting items are different depending on the selected template.  |
| Internet Key Exchange (IKE) | <p>IKE is a communication protocol that is used to exchange encryption keys in order to carry out encrypted communication using IPsec. To carry out encrypted communication for that time only, the encryption algorithm that is necessary for IPsec is determined and the encryption keys are shared. For IKE, the encryption keys are exchanged using the Diffie-Hellman key exchange method, and encrypted communication that is limited to IKE is carried out.</p> <p>If you selected <b>Custom</b> in <b>Use Prefixed Template</b>, select <b>IKEv1</b>.</p>  |
| Authentication Type         | <ul style="list-style-type: none"> <li>• <b>Diffie-Hellman Group</b> <p>This key exchange method allows secret keys to be securely exchanged over an unprotected network. The Diffie-Hellman key exchange method uses a discrete logarithm problem, not the secret key, to send and receive open information that was generated using a random number and the secret key.</p> <p>Select <b>Group1</b>, <b>Group2</b>, <b>Group5</b>, or <b>Group14</b>.</p> </li> <li>• <b>Encryption</b> <p>Select <b>DES</b>, <b>3DES</b>, <b>AES-CBC 128</b>, or <b>AES-CBC 256</b>.</p> </li> <li>• <b>Hash</b> <p>Select <b>MD5</b>, <b>SHA1</b>, <b>SHA256</b>, <b>SHA384</b> or <b>SHA512</b>.</p> </li> <li>• <b>SA Lifetime</b> <p>Specify the IKE SA lifetime.</p> <p>Type the time (seconds) and number of kilobytes (KByte).</p> </li> </ul>   |
| Encapsulating Security      | <ul style="list-style-type: none"> <li>• <b>Protocol</b> <p>Select <b>ESP</b>, <b>AH</b>, or <b>AH+ESP</b>.</p> <hr/> <ul style="list-style-type: none"> <li>-  ESP is a protocol for carrying out encrypted communication using IPsec. ESP encrypts the payload (communicated contents) and adds additional information. The IP packet comprises the header and the encrypted payload, which follows the header. In addition to the encrypted data, the IP packet also includes information regarding the encryption method and encryption key, the authentication data, and so on.</li> <li>- AH is part of the IPsec protocol that authenticates the sender and prevents manipulation (ensures the completeness) of the data. In the IP packet, the data is inserted immediately after the header. In addition, the packets include hash values, which are calculated using an equation from the communicated contents, secret key, and so on, in order to prevent the falsification of the sender and manipulation of the data. Unlike ESP, the communicated contents are not encrypted, and the data is sent and received as plain text.</li> </ul> <hr/> </li> <li>• <b>Encryption (Not available for the AH option.)</b> <p>Select <b>DES</b>, <b>3DES</b>, <b>AES-CBC 128</b>, or <b>AES-CBC 256</b>.</p> </li> <li>• <b>Hash</b> <p>Select <b>None</b>, <b>MD5</b>, <b>SHA1</b>, <b>SHA256</b>, <b>SHA384</b>, or <b>SHA512</b>.</p> <p><b>None</b> can be selected only when <b>ESP</b> is selected in <b>Protocol</b>.</p> </li> </ul> |

| Option                               | Description   |
|--------------------------------------|---|
|                                      | <p>When <b>AH+ESP</b> is selected in <b>Protocol</b>, select each protocol for <b>Hash(ESP)</b> and <b>Hash(AH)</b>.</p> <ul style="list-style-type: none"> <li>• <b>SA Lifetime</b><br/>Specify the IKE SA lifetime.<br/>Type the time (seconds) and number of kilobytes (KByte).</li> <li>• <b>Encapsulation Mode</b><br/>Select <b>Transport</b> or <b>Tunnel</b>.</li> <li>• <b>Remote Router IP-Address</b><br/>Type the IP address (IPv4 or IPv6) of the remote router. Enter this information only when the <b>Tunnel</b> mode is selected.</li> </ul> <hr/> <p> SA (Security Association) is an encrypted communication method using IPsec or IPv6 that exchanges and shares information, such as the encryption method and encryption key, in order to establish a secure communication channel before communication begins. SA may also refer to a virtual encrypted communication channel that has been established. The SA used for IPsec establishes the encryption method, exchanges the keys, and carries out mutual authentication according to the IKE (Internet Key Exchange) standard procedure. In addition, the SA is updated periodically.</p> |
| <b>Perfect Forward Secrecy (PFS)</b> | <p>PFS does not derive keys from previous keys that were used to encrypt messages. In addition, if a key that is used to encrypt a message was derived from a parent key, that parent key is not used to derive other keys. Therefore, even if a key is compromised, the damage will be limited only to the messages that were encrypted using that key.</p> <p>Select <b>Enabled</b> or <b>Disabled</b>.</p>   |
| <b>Authentication Method</b>         | <p>Select the authentication method. Select <b>Pre-Shared Key</b> or <b>Certificates</b>.</p>   |
| <b>Pre-Shared Key</b>                | <p>When encrypting communication, the encryption key is exchanged and shared beforehand using another channel.</p> <p>If you selected <b>Pre-Shared Key</b> for the <b>Authentication Method</b>, type the <b>Pre-Shared Key</b> (up to 32 characters).</p> <ul style="list-style-type: none"> <li>• <b>Local/ID Type/ID</b><br/>Select the sender's ID type, and then type the ID.<br/>Select <b>IPv4 Address</b>, <b>IPv6 Address</b>, <b>FQDN</b>, <b>E-mail Address</b>, or <b>Certificate</b> for the type.<br/>If you select <b>Certificate</b>, type the common name of the certificate in the <b>ID</b> field.</li> <li>• <b>Remote/ID Type/ID</b><br/>Select the recipient's ID type, and then type the ID.<br/>Select <b>IPv4 Address</b>, <b>IPv6 Address</b>, <b>FQDN</b>, <b>E-mail Address</b>, or <b>Certificate</b> for the type.<br/>If you select <b>Certificate</b>, type the common name of the certificate in the <b>ID</b> field.</li> </ul>  |
| <b>Certificate</b>                   | <p>If you selected <b>Certificates</b> for <b>Authentication Method</b>, select the certificate.</p> <hr/> <p> You can select only the certificates that were created using the <b>Certificate</b> page of Web Based Management's Security configuration screen.</p>   |





## Related Information

- [Configure an IPsec Template Using Web Based Management](#)
-

## IKEv2 Settings for an IPsec Template

| Option                             | Description   |
|------------------------------------|---|
| <b>Template Name</b>               | Type a name for the template (up to 16 characters).   |
| <b>Use Prefixed Template</b>       | Select <b>Custom</b> , <b>IKEv2 High Security</b> , or <b>IKEv2 Medium Security</b> . The setting items are different depending on the selected template.   |
| <b>Internet Key Exchange (IKE)</b> | IKE is a communication protocol that is used to exchange encryption keys in order to carry out encrypted communication using IPsec. To carry out encrypted communication for that time only, the encryption algorithm that is necessary for IPsec is determined and the encryption keys are shared. For IKE, the encryption keys are exchanged using the Diffie-Hellman key exchange method, and encrypted communication that is limited to IKE is carried out.<br>If you selected <b>Custom</b> in <b>Use Prefixed Template</b> , select <b>IKEv2</b> .  |
| <b>Authentication Type</b>         | <ul style="list-style-type: none"> <li>• <b>Diffie-Hellman Group</b><br/>This key exchange method allows secret keys to be securely exchanged over an unprotected network. The Diffie-Hellman key exchange method uses a discrete logarithm problem, not the secret key, to send and receive open information that was generated using a random number and the secret key.<br/>Select <b>Group1</b>, <b>Group2</b>, <b>Group5</b>, or <b>Group14</b>.</li> <li>• <b>Encryption</b><br/>Select <b>DES</b>, <b>3DES</b>, <b>AES-CBC 128</b>, or <b>AES-CBC 256</b>.</li> <li>• <b>Hash</b><br/>Select <b>MD5</b>, <b>SHA1</b>, <b>SHA256</b>, <b>SHA384</b> or <b>SHA512</b>.</li> <li>• <b>SA Lifetime</b><br/>Specify the IKE SA lifetime.<br/>Type the time (seconds) and number of kilobytes (KByte).</li> </ul>  |
| <b>Encapsulating Security</b>      | <ul style="list-style-type: none"> <li>• <b>Protocol</b><br/>Select <b>ESP</b>.<br/><br/> ESP is a protocol for carrying out encrypted communication using IPsec. ESP encrypts the payload (communicated contents) and adds additional information. The IP packet comprises the header and the encrypted payload, which follows the header. In addition to the encrypted data, the IP packet also includes information regarding the encryption method and encryption key, the authentication data, and so on.</li> <li>• <b>Encryption</b><br/>Select <b>DES</b>, <b>3DES</b>, <b>AES-CBC 128</b>, or <b>AES-CBC 256</b>.</li> <li>• <b>Hash</b><br/>Select <b>MD5</b>, <b>SHA1</b>, <b>SHA256</b>, <b>SHA384</b>, or <b>SHA512</b>.</li> <li>• <b>SA Lifetime</b><br/>Specify the IKE SA lifetime.<br/>Type the time (seconds) and number of kilobytes (KByte).</li> <li>• <b>Encapsulation Mode</b><br/>Select <b>Transport</b> or <b>Tunnel</b>.</li> <li>• <b>Remote Router IP-Address</b><br/>Type the IP address (IPv4 or IPv6) of the remote router. Enter this information only when the <b>Tunnel</b> mode is selected.</li> </ul> |

| Option                               | Description  |
|--------------------------------------|--|
|                                      |  <p>SA (Security Association) is an encrypted communication method using IPsec or IPv6 that exchanges and shares information, such as the encryption method and encryption key, in order to establish a secure communication channel before communication begins. SA may also refer to a virtual encrypted communication channel that has been established. The SA used for IPsec establishes the encryption method, exchanges the keys, and carries out mutual authentication according to the IKE (Internet Key Exchange) standard procedure. In addition, the SA is updated periodically.</p>  |
| <b>Perfect Forward Secrecy (PFS)</b> | <p>PFS does not derive keys from previous keys that were used to encrypt messages. In addition, if a key that is used to encrypt a message was derived from a parent key, that parent key is not used to derive other keys. Therefore, even if a key is compromised, the damage will be limited only to the messages that were encrypted using that key.</p> <p>Select <b>Enabled</b> or <b>Disabled</b>.</p>  |
| <b>Authentication Method</b>         | <p>Select the authentication method. Select <b>Pre-Shared Key</b>, <b>Certificates</b>, <b>EAP - MD5</b>, or <b>EAP - MS-CHAPv2</b>.</p>  <p>EAP is an authentication protocol that is an extension of PPP. By using EAP with IEEE802.1x, a different key is used for user authentication during each session.</p> <p>The following settings are necessary only when <b>EAP - MD5</b> or <b>EAP - MS-CHAPv2</b> is selected in <b>Authentication Method</b>:</p> <ul style="list-style-type: none"> <li>• <b>Mode</b><br/>Select <b>Server-Mode</b> or <b>Client-Mode</b>.</li> <li>• <b>Certificate</b><br/>Select the certificate.</li> <li>• <b>User Name</b><br/>Type the user name (up to 32 characters).</li> <li>• <b>Password</b><br/>Type the password (up to 32 characters). The password must be entered two times for confirmation.</li> </ul>                        |
| <b>Pre-Shared Key</b>                | <p>When encrypting communication, the encryption key is exchanged and shared beforehand using another channel.</p> <p>If you selected <b>Pre-Shared Key</b> for the <b>Authentication Method</b>, type the <b>Pre-Shared Key</b> (up to 32 characters).</p> <ul style="list-style-type: none"> <li>• <b>Local/ID Type/ID</b><br/>Select the sender's ID type, and then type the ID.<br/>Select <b>IPv4 Address</b>, <b>IPv6 Address</b>, <b>FQDN</b>, <b>E-mail Address</b>, or <b>Certificate</b> for the type.<br/>If you select <b>Certificate</b>, type the common name of the certificate in the <b>ID</b> field.</li> <li>• <b>Remote/ID Type/ID</b><br/>Select the recipient's ID type, and then type the ID.<br/>Select <b>IPv4 Address</b>, <b>IPv6 Address</b>, <b>FQDN</b>, <b>E-mail Address</b>, or <b>Certificate</b> for the type.<br/>If you select <b>Certificate</b>, type the common name of the certificate in the <b>ID</b> field.</li> </ul> |
| <b>Certificate</b>                   | <p>If you selected <b>Certificates</b> for <b>Authentication Method</b>, select the certificate.</p>   |

---



| Option | Description   |
|--------|---|
|        |  You can select only the certificates that were created using the <b>Certificate</b> page of Web Based Management's Security configuration screen. |





### Related Information

- [Configure an IPsec Template Using Web Based Management](#)
-

## Manual Settings for an IPsec Template

| Option                              | Description   |
|-------------------------------------|---|
| <b>Template Name</b>                | Type a name for the template (up to 16 characters).   |
| <b>Use Prefixed Template</b>        | Select <b>Custom</b> .  |
| <b>Internet Key Exchange (IKE)</b>  | <p>IKE is a communication protocol that is used to exchange encryption keys in order to carry out encrypted communication using IPsec. To carry out encrypted communication for that time only, the encryption algorithm that is necessary for IPsec is determined and the encryption keys are shared. For IKE, the encryption keys are exchanged using the Diffie-Hellman key exchange method, and encrypted communication that is limited to IKE is carried out.</p> <p>Select <b>Manual</b>.</p>   |
| <b>Authentication Key (ESP, AH)</b> | <p>Type the <b>In/Out</b> values.</p> <p>These settings are necessary when <b>Custom</b> is selected for <b>Use Prefixed Template</b>, <b>Manual</b> is selected for <b>Internet Key Exchange (IKE)</b>, and a setting other than <b>None</b> is selected for <b>Hash</b> for <b>Encapsulating Security</b> section.</p> <hr/> <p> The number of characters you can set differs depending on the setting you chose for <b>Hash</b> in the <b>Encapsulating Security</b> section.</p> <p>If the length of the specified authentication key is different than the selected hash algorithm, an error will occur.</p> <ul style="list-style-type: none"> <li>• <b>MD5</b>: 128 bits (16 bytes)</li> <li>• <b>SHA1</b>: 160 bits (20 bytes)</li> <li>• <b>SHA256</b>: 256 bits (32 bytes)</li> <li>• <b>SHA384</b>: 384 bits (48 bytes)</li> <li>• <b>SHA512</b>: 512 bits (64 bytes)</li> </ul> <p>When you specify the key in ASCII Code, enclose the characters in double quotation marks (").</p> <hr/> |
| <b>Code key (ESP)</b>               | <p>Type the <b>In/Out</b> values.</p> <p>These settings are necessary when <b>Custom</b> is selected in <b>Use Prefixed Template</b>, <b>Manual</b> is selected in <b>Internet Key Exchange (IKE)</b>, and <b>ESP</b> is selected in <b>Protocol</b> in <b>Encapsulating Security</b>.</p> <hr/> <p> The number of characters you can set differs depending on the setting you chose for <b>Encryption</b> in the <b>Encapsulating Security</b> section.</p> <p>If the length of the specified code key is different than the selected encryption algorithm, an error will occur.</p> <ul style="list-style-type: none"> <li>• <b>DES</b>: 64 bits (8 bytes)</li> <li>• <b>3DES</b>: 192 bits (24 bytes)</li> <li>• <b>AES-CBC 128</b>: 128 bits (16 bytes)</li> <li>• <b>AES-CBC 256</b>: 256 bits (32 bytes)</li> </ul> <p>When you specify the key in ASCII Code, enclose the characters in double quotation marks (").</p> <hr/>   |
| <b>SPI</b>                          | <p>These parameters are used to identify security information. Generally, a host has multiple Security Associations (SAs) for several types of IPsec communication. Therefore, it is necessary to identify the applicable SA when an IPsec packet is received. The SPI parameter, which identifies the SA, is included in the Authentication Header (AH) and Encapsulating Security Payload (ESP) header.</p>   |

| Option                               | Description  |
|--------------------------------------|--|
|                                      | <p>These settings are necessary when <b>Custom</b> is selected for <b>Use Prefixed Template</b>, and <b>Manual</b> is selected for <b>Internet Key Exchange (IKE)</b>.</p> <p>Enter the <b>In/Out</b> values. (3-10 characters)</p>  |
| <p><b>Encapsulating Security</b></p> | <ul style="list-style-type: none"> <li>• <b>Protocol</b><br/>Select <b>ESP</b> or <b>AH</b>.</li> </ul> <hr/> <ul style="list-style-type: none"> <li>  <ul style="list-style-type: none"> <li>- ESP is a protocol for carrying out encrypted communication using IPsec. ESP encrypts the payload (communicated contents) and adds additional information. The IP packet comprises the header and the encrypted payload, which follows the header. In addition to the encrypted data, the IP packet also includes information regarding the encryption method and encryption key, the authentication data, and so on.</li> <li>- AH is part of the IPsec protocol that authenticates the sender and prevents manipulation of the data (ensures the completeness of the data). In the IP packet, the data is inserted immediately after the header. In addition, the packets include hash values, which are calculated using an equation from the communicated contents, secret key, and so on, in order to prevent the falsification of the sender and manipulation of the data. Unlike ESP, the communicated contents are not encrypted, and the data is sent and received as plain text.</li> </ul> </li> </ul> <hr/> <ul style="list-style-type: none"> <li>• <b>Encryption (Not available for the AH option.)</b><br/>Select <b>DES</b>, <b>3DES</b>, <b>AES-CBC 128</b>, or <b>AES-CBC 256</b>.</li> <li>• <b>Hash</b><br/>Select <b>None</b>, <b>MD5</b>, <b>SHA1</b>, <b>SHA256</b>, <b>SHA384</b>, or <b>SHA512</b>.<br/><b>None</b> can be selected only when <b>ESP</b> is selected in <b>Protocol</b>.<br/>When <b>AH+ESP</b> is selected in <b>Protocol</b>, select each protocol for <b>Hash(ESP)</b> and <b>Hash(AH)</b>.</li> <li>• <b>SA Lifetime</b><br/>Specify the IKE SA lifetime.<br/>Type the time (seconds) and number of kilobytes (KByte).</li> <li>• <b>Encapsulation Mode</b><br/>Select <b>Transport</b> or <b>Tunnel</b>.</li> <li>• <b>Remote Router IP-Address</b><br/>Type the IP address (IPv4 or IPv6) of the remote router. Enter this information only when the <b>Tunnel</b> mode is selected.</li> </ul> <hr/> <ul style="list-style-type: none"> <li>  <p>SA (Security Association) is an encrypted communication method using IPsec or IPv6 that exchanges and shares information, such as the encryption method and encryption key, in order to establish a secure communication channel before communication begins. SA may also refer to a virtual encrypted communication channel that has been established. The SA used for IPsec establishes the encryption method, exchanges the keys, and carries out mutual authentication according to the IKE (Internet Key Exchange) standard procedure. In addition, the SA is updated periodically.</p> </li> </ul> |



## Related Information

- [Configure an IPsec Template Using Web Based Management](#)



## Use IEEE 802.1x Authentication for a Wired or a Wireless Network

- [What Is IEEE 802.1x Authentication?](#)
- [Configure IEEE 802.1x Authentication for a Wired or Wireless Network Using Web Based Management \(Web Browser\)](#)
- [IEEE 802.1x Authentication Methods](#)

## What Is IEEE 802.1x Authentication?

IEEE 802.1x is an IEEE standard for wired and wireless networks that limits access from unauthorised network devices. Your Brother machine (supplicant) sends an authentication request to a RADIUS server (Authentication server) through your access point or HUB. After your request has been verified by the RADIUS server, your machine can access the network.



### Related Information

- [Use IEEE 802.1x Authentication for a Wired or a Wireless Network](#)
-

## Configure IEEE 802.1x Authentication for a Wired or Wireless Network Using Web Based Management (Web Browser)

- If you configure your machine using EAP-TLS authentication, you must install the client certificate issued by a CA before you start configuration. Contact your network administrator about the client certificate. If you have installed more than one certificate, we recommend writing down the certificate name you want to use.
- Before you verify the server certificate, you must import the CA certificate issued by the CA that signed the server certificate. Contact your network administrator or your Internet Service Provider (ISP) to confirm whether a CA certificate import is necessary.



You can also configure IEEE 802.1x authentication using the Wireless Setup Wizard from the control panel (Wireless network).

1. Start your web browser.
2. Type "https://machine's IP address" in your browser's address bar (where "machine's IP address" is the machine's IP address).

For example:

https://192.168.1.2



If you are using a Domain Name System or enable a NetBIOS name, you can type another name, such as "SharedPrinter" instead of the IP address.

For example:

https://SharedPrinter

If you enable a NetBIOS name, you can also use the node name.

For example:

https://brnxxxxxxxxxxxxx

The NetBIOS name can be found in the Network Configuration Report.

3. If required, type the password in the **Login** field, and then click **Login**.



The default password to manage this machine's settings is located on the back of the machine and marked "Pwd".

4. Go to the navigation menu, and then click **Network**.



Start from ☰, if the navigation menu is not shown on the left side of the screen.

5. Do one of the following:
  - For the wired network  
Click **Wired** > **Wired 802.1x Authentication**.
  - For the wireless network  
Click **Wireless** > **Wireless (Enterprise)**.
6. Configure the IEEE 802.1x authentication settings.



- To enable IEEE 802.1x authentication for wired networks, select **Enabled** for **Wired 802.1x status** on the **Wired 802.1x Authentication** page.
- If you are using **EAP-TLS** authentication, you must select the client certificate installed (shown with certificate name) for verification from the **Client Certificate** drop-down list.
- If you select **EAP-FAST**, **PEAP**, **EAP-TTLS**, or **EAP-TLS** authentication, select the verification method from the **Server Certificate Verification** drop-down list. Verify the server certificate using the CA certificate, imported to the machine in advance, issued by the CA that signed the server certificate.

Select one of the following verification methods from the **Server Certificate Verification** drop-down list:

| Option                     | Description  |
|----------------------------|--|
| <b>No Verification</b>     | The server certificate can always be trusted. The verification is not performed.   |
| <b>CA Cert.</b>            | The verification method to check the CA reliability of the server certificate, using the CA certificate issued by the CA that signed the server certificate. |
| <b>CA Cert. + ServerID</b> | The verification method to check the common name <sup>1</sup> value of the server certificate, in addition to the CA reliability of the server certificate.  |

7. When finished with configuration, click **Submit**.

For wired networks: After configuring, connect your machine to the IEEE 802.1x supported network. After a few minutes, print the Network Configuration Report to check the **<Wired IEEE 802.1x>** status.

| Option         | Description  |
|----------------|--|
| <b>Success</b> | The wired IEEE 802.1x function is enabled and the authentication was successful. |
| <b>Failed</b>  | The wired IEEE 802.1x function is enabled; however, the authentication failed.   |
| <b>Off</b>     | The wired IEEE 802.1x function is not available.                                 |



## Related Information

- [Use IEEE 802.1x Authentication for a Wired or a Wireless Network](#)

### Related Topics:

- [Configure Certificates for Device Security](#)

<sup>1</sup> The common name verification compares the common name of the server certificate to the character string configured for the **Server ID**. Before you use this method, contact your system administrator about the server certificate's common name and then configure **Server ID**.

## IEEE 802.1x Authentication Methods

### EAP-FAST

Extensible Authentication Protocol-Flexible Authentication via Secured Tunneling (EAP-FAST) has been developed by Cisco Systems, Inc., which uses a user ID and password for authentication, and symmetric key algorithms to achieve a tunnelled authentication process.

The Brother machine supports the following inner authentication methods:

- EAP-FAST/NONE
- EAP-FAST/MS-CHAPv2
- EAP-FAST/GTC

### EAP-MD5 (Wired network)

Extensible Authentication Protocol-Message Digest Algorithm 5 (EAP-MD5) uses a user ID and password for challenge-response authentication.

### PEAP

Protected Extensible Authentication Protocol (PEAP) is a version of EAP method developed by Cisco Systems, Inc., Microsoft Corporation and RSA Security. PEAP creates an encrypted Secure Sockets Layer (SSL)/Transport Layer Security (TLS) tunnel between a client and an authentication server, for sending a user ID and password. PEAP provides mutual authentication between the server and the client.

The Brother machine supports the following inner authentications:

- PEAP/MS-CHAPv2
- PEAP/GTC

### EAP-TTLS

Extensible Authentication Protocol-Tunneled Transport Layer Security (EAP-TTLS) has been developed by Funk Software and Certicom. EAP-TTLS creates a similar encrypted SSL tunnel to PEAP, between a client and an authentication server, for sending a user ID and password. EAP-TTLS provides mutual authentication between the server and the client.

The Brother machine supports the following inner authentications:

- EAP-TTLS/CHAP
- EAP-TTLS/MS-CHAP
- EAP-TTLS/MS-CHAPv2
- EAP-TTLS/PAP

### EAP-TLS

Extensible Authentication Protocol-Transport Layer Security (EAP-TLS) requires digital certificate authentication both at a client and an authentication server.



### Related Information

- [Use IEEE 802.1x Authentication for a Wired or a Wireless Network](#)

## Use Active Directory Authentication

- [Introduction to Active Directory Authentication](#)
- [Configure Active Directory Authentication Using Web Based Management](#)
- [Log On to Change the Machine Settings Using the Machine's Control Panel \(Active Directory Authentication\)](#)

## Introduction to Active Directory Authentication

Active Directory Authentication restricts the use of your machine. If Active Directory Authentication is enabled, the machine's control panel will be locked. You cannot change the machine's settings until you enter a User ID and password.

Active Directory Authentication offers the following features:

- Stores incoming print data
- Stores incoming fax data
- Obtains the email address from the Active Directory server based on your User ID, when sending scanned data to an email server.

To use this feature, select the **On** option for the **Get Mail Address** setting and **LDAP + kerberos** authentication method. Your email address will be set as the sender when the machine sends scanned data to an email server, or as the recipient if you want to send the scanned data to your email address.

When Active Directory Authentication is enabled, your machine stores all incoming fax data. After you log on, the machine prints the stored fax data.

You can change the Active Directory Authentication settings using Web Based Management.



### Related Information

- [Use Active Directory Authentication](#)

## Configure Active Directory Authentication Using Web Based Management

Active Directory authentication supports Kerberos authentication and NTLMv2 authentication. You must configure the SNTP protocol (network time server) and DNS server configuration for authentication.

1. Start your web browser.
2. Type "https://machine's IP address" in your browser's address bar (where "machine's IP address" is the machine's IP address).  
For example:  
https://192.168.1.2
3. If required, type the password in the **Login** field, and then click **Login**.



The default password to manage this machine's settings is located on the back of the machine and marked "Pwd".

4. Go to the navigation menu, and then click **Administrator > Restriction Management** or **User Restriction Function**.



Start from , if the navigation menu is not shown on the left side of the screen.

5. Select **Active Directory Authentication**.
6. Click **Submit**.
7. Select the **Active Directory Authentication** menu in the navigation bar.
8. Configure the following settings:

| Option                                      | Description   |
|---|---|
| <b>Storage Fax RX Data</b>                  | Select this option to store incoming fax data. You can print all incoming fax data after you log on to the machine.   |
| <b>Remember User ID</b>                     | Select this option to save your User ID.  |
| <b>Active Directory Server Address</b>      | Type the IP address or the server name (for example: ad.example.com) of the Active Directory Server.  |
| <b>Active Directory Domain Name</b>         | Type the Active Directory domain name.  |
| <b>Protocol &amp; Authentication Method</b> | Select the protocol and authentication method.  |
| <b>Get Mail Address</b>                     | Select this option to obtain logged on user's email address from the Active Directory server. (available only for <b>LDAP + kerberos</b> authentication method) |
| <b>Get User's Home Directory</b>            | Select this option to obtain your home directory as the Scan to Network destination. (available only for <b>LDAP + kerberos</b> authentication method)          |
| <b>LDAP Server Port</b>                     | Type the port number to connect the Active Directory server via LDAP (available only for <b>LDAP + kerberos</b> authentication method).                         |
| <b>LDAP Search Root</b>                     | Type the LDAP search root (available only for <b>LDAP + kerberos</b> authentication method).  |

9. Click **Submit**.





## Related Information

- [Use Active Directory Authentication](#)
-

## Log On to Change the Machine Settings Using the Machine's Control Panel (Active Directory Authentication)

When Active Directory Authentication is enabled, the machine's control panel will be locked until you enter your User ID and password on the machine's control panel.

1. On the machine's control panel, use the touchscreen to enter your User ID and Password.
2. Press [OK].
3. When authentication is successful, the machine's control panel will be unlocked.



### Related Information

- [Use Active Directory Authentication](#)

## Use LDAP Authentication

- [Introduction to LDAP Authentication](#)
- [Configure LDAP Authentication Using Web Based Management](#)
- [Log On to Change the Machine Settings Using the Machine's Control Panel \(LDAP Authentication\)](#)

## Introduction to LDAP Authentication

LDAP Authentication restricts the use of your machine. If LDAP Authentication is enabled, the machine's control panel will be locked. You cannot change the machine's settings until you enter a User ID and password.

LDAP Authentication offers the following features:

- Stores incoming print data
- Stores incoming fax data
- Obtains the email address from the LDAP server based on your User ID, when sending scanned data to an email server.

To use this feature, select the **On** option for the **Get Mail Address** setting. Your email address will be set as the sender when the machine sends scanned data to an email server, or as the recipient if you want to send the scanned data to your email address.

When LDAP Authentication is enabled, your machine stores all incoming fax data. After you log on, the machine prints the stored fax data.

You can change the LDAP Authentication settings using Web Based Management.



### Related Information

- [Use LDAP Authentication](#)

## Configure LDAP Authentication Using Web Based Management

1. Start your web browser.
2. Type "https://machine's IP address" in your browser's address bar (where "machine's IP address" is the machine's IP address).

For example:

https://192.168.1.2

3. If required, type the password in the **Login** field, and then click **Login**.



The default password to manage this machine's settings is located on the back of the machine and marked "Pwd".

4. Go to the navigation menu, and then click **Administrator > Restriction Management** or **User Restriction Function**.



Start from ☰, if the navigation menu is not shown on the left side of the screen.

5. Select **LDAP Authentication**.
6. Click **Submit**.
7. Click the **LDAP Authentication** menu.
8. Configure the following settings:

| Option                                | Description   |
|---------------------------------------|---|
| <b>Storage Fax RX Data</b>            | Select this option to store incoming fax data. You can print all incoming fax data after you log on to the machine. |
| <b>Remember User ID</b>               | Select this option to save your User ID.  |
| <b>LDAP Server Address</b>            | Type the IP address or the server name (for example: ldap.example.com) of the LDAP server.                          |
| <b>Get Mail Address</b>               | Select this option to obtain the logged user's email address from the LDAP server.                                  |
| <b>Get User's Home Directory</b>      | Select this option to obtain your home directory as the Scan to Network destination.                                |
| <b>LDAP Server Port</b>               | Type the LDAP server port number.   |
| <b>LDAP Search Root</b>               | Type the LDAP search root directory.  |
| <b>Attribute of Name (Search Key)</b> | Type the attribute you want to use as a search key.   |

9. Click **Submit**.



### Related Information

- [Use LDAP Authentication](#)

## Log On to Change the Machine Settings Using the Machine's Control Panel (LDAP Authentication)

When LDAP Authentication is enabled, the machine's control panel will be locked until you enter your User ID and password on the machine's control panel.

1. On the machine's control panel, use the touchscreen to enter your User ID and Password.
2. Press [OK].
3. When authentication is successful, the machine's control panel will be unlocked.



### Related Information

- [Use LDAP Authentication](#)

## Use Secure Function Lock 3.0

Secure Function Lock 3.0 increases security by restricting the functions available on your machine.

- [Before Using Secure Function Lock 3.0](#)
- [Configure Secure Function Lock 3.0 Using Web Based Management](#)
- [Scan Using Secure Function Lock 3.0](#)
- [Configure Public Mode for Secure Function Lock 3.0](#)
- [Configure Personal Home Screen Settings Using Web Based Management](#)
- [Additional Secure Function Lock 3.0 Features](#)
- [Register a new ID Card Using the Machine's Control Panel](#)

## Before Using Secure Function Lock 3.0

Use Secure Function Lock to configure passwords, set specific user page limits, and grant access to some or all of the functions listed here.

You can configure and change the following Secure Function Lock 3.0 settings using Web Based Management:

- **Print**

Print includes print jobs sent via AirPrint, Brother iPrint&Scan, and Brother Mobile Connect.

If you register user login names in advance, the users do not need to enter their passwords when they use the print function.

- **Colour Print**

- **Copy**

- **Scan**

Scan includes scan jobs sent via Brother iPrint&Scan and Brother Mobile Connect.

- **Send** (supported models only)

- **Receive** (supported models only)

- **USB Direct Print**

- **Scan to USB** (supported models only)

- **Web Connect** (supported models only)

- **Apps** (supported models only)

- **Page Limits**

- **Page Counters**

- **Card ID (NFC ID)** (supported models only)

If you register users' Card IDs in advance, registered users can activate the machine by touching their registered cards to the machines' NFC symbol.



### Related Information

- [Use Secure Function Lock 3.0](#)



## Configure Secure Function Lock 3.0 Using Web Based Management

1. Start your web browser.
2. Type "https://machine's IP address" in your browser's address bar (where "machine's IP address" is the machine's IP address).

For example:

https://192.168.1.2

3. If required, type the password in the **Login** field, and then click **Login**.



---

The default password to manage this machine's settings is located on the back of the machine and marked "Pwd".

---

4. Go to the navigation menu, and then click **Administrator > Restriction Management** or **User Restriction Function**.



---

Start from ☰, if the navigation menu is not shown on the left side of the screen.

---

5. Select **Secure Function Lock**.
6. Click **Submit**.
7. Click the **Restricted Functions** menu in the navigation bar.
8. In the **User List / Restricted Functions** field, type a group name or user name.
9. In the **Print** and the other columns, select a checkbox to allow, or clear a checkbox to restrict, the function listed.
10. To configure the maximum page count, select the **On** checkbox in the **Page Limits** column, and then type the maximum number in the **Max. Pages** field.
11. Click **Submit**.
12. Click the **User List** menu.
13. In the **User List** field, type the user name.
14. In the **Password** field, type a password.



---

The number of characters you can set differs depending on the model.

---

15. In the **E-mail Address** field, type the user's email address (available only for certain models).
16. To register the user's Card ID, type the card number in the **Card ID (NFC ID)** field (available only for certain models).
17. Select **User List / Restricted Functions** from the drop-down list for each user.
18. (For MFC-L9670CDN/MFC-EX670) Select **Home Screen** from the drop-down list for each user.
19. Click **Submit**.



---

You can also change the user list lockout settings in the **Secure Function Lock** menu.

---



### Related Information

- [Use Secure Function Lock 3.0](#)

## Scan Using Secure Function Lock 3.0

### Setting Scan restrictions (for administrators)

Secure Function Lock 3.0 allows an administrator to restrict which users are allowed to scan. When the Scan feature is set to Off for the public user setting, only users who have the **Scan** checkbox selected will be able to scan.

### Using the Scan feature (for restricted users)

- To scan using the machine's control panel:  
Restricted users must enter their passwords on the machine's control panel to access Scan mode.
- To scan from a computer:  
Restricted users must enter their passwords on the machine's control panel before scanning from their computers. If the password is not entered on the machine's control panel, an error message will appear on the user's computer.



### Related Information

- [Use Secure Function Lock 3.0](#)

## Configure Public Mode for Secure Function Lock 3.0

Use the Secure Function Lock screen to set up Public Mode, which limits the functions available to public users. Public users will not need to enter a password to access the features made available through Public Mode settings.



Public Mode includes print jobs sent via Brother iPrint&Scan and Brother Mobile Connect.

1. Start your web browser.
2. Type "https://machine's IP address" in your browser's address bar (where "machine's IP address" is the machine's IP address).

For example:

https://192.168.1.2

3. If required, type the password in the **Login** field, and then click **Login**.



The default password to manage this machine's settings is located on the back of the machine and marked "Pwd".

4. Go to the navigation menu, and then click **Administrator > Restriction Management** or **User Restriction Function**.



Start from , if the navigation menu is not shown on the left side of the screen.

5. Select **Secure Function Lock**.
6. Click **Submit**.
7. Click the **Restricted Functions** menu in the navigation bar.
8. In the **Public Mode** row, select a checkbox to allow, or clear a checkbox to restrict, the function listed.
9. Click **Submit**.



### Related Information

- [Use Secure Function Lock 3.0](#)

## Configure Personal Home Screen Settings Using Web Based Management

**Related Models:** MFC-L9670CDN/MFC-EX670

As Administrator, you can specify which tabs users can view on their personal home screens. These tabs provide quick access to users' favourite shortcuts, which they can assign to their personal home screen tabs from the machine's control panel.

1. Start your web browser.
2. Type "https://machine's IP address" in your browser's address bar (where "machine's IP address" is the machine's IP address).

For example:

https://192.168.1.2

3. If required, type the password in the **Login** field, and then click **Login**.



The default password to manage this machine's settings is located on the back of the machine and marked "Pwd".

4. Go to the navigation menu, and then click **Administrator > Restriction Management** or **User Restriction Function**.



Start from , if the navigation menu is not shown on the left side of the screen.

5. Select **Secure Function Lock**.
6. In the **Tab Settings** field, select **Personal** for the tab names you want to use as your personal home screen.
7. Click **Submit**.
8. Click the **Restricted Functions** menu in the navigation bar.
9. In the **User List / Restricted Functions** field, type a group name or user name.
10. Click **Submit**.
11. Click the **User List** menu.
12. In the **User List** field, type the user name.
13. In the **Password** field, type a password.



The number of characters you can set differs depending on the model.

14. To register the user's Card ID, type the card number in the **Card ID (NFC ID)** field (available only for certain models).
15. Select **User List / Restricted Functions** from the drop-down list for each user.
16. Select the tab name from the **Home Screen** drop-down list for each user.
17. Click **Submit**.



### Related Information

- [Use Secure Function Lock 3.0](#)

### Related Topics:

- [Save Your Favourite Settings as a Shortcut](#)

## Additional Secure Function Lock 3.0 Features

Configure the following features in the Secure Function Lock screen:

### All Counter Reset

Click **All Counter Reset**, in the **Page Counters** column, to reset the page counter.

### Export to CSV file

Click **Export to CSV file**, to export the current and last page counter including **User List / Restricted Functions** information as a CSV file.

### Card ID (NFC ID) (supported models only)

Click the **User List** menu, and then type a user's Card ID in the **Card ID (NFC ID)** field. You can use your IC card for authentication.

### Last Counter Record

Click **Last Counter Record** if you want the machine to retain the page count after the counter has been reset.



### Related Information

- [Use Secure Function Lock 3.0](#)

## Register a new ID Card Using the Machine's Control Panel

1. Touch the Near-Field Communication (NFC) symbol on the machine's control panel with a registered Integrated Circuit Card (IC Card).
2. Touch your user ID on the machine's control panel.
3. Press [Register Card].
4. Touch a new IC Card to the NFC symbol.  
The new IC Card's number is then registered to the machine.



For the supported IC Card types, visit [support.brother.com](http://support.brother.com) to see the **FAQs & Troubleshooting** page.

5. Press [OK].



### Related Information

- [Use Secure Function Lock 3.0](#)

## **Send or Receive an Email Securely**

- [Configure Email Sending or Receiving Using Web Based Management](#)
- [Send an Email with User Authentication](#)
- [Send or Receive an Email Securely Using SSL/TLS](#)

## Configure Email Sending or Receiving Using Web Based Management

We recommend using Web Based Management to configure secured email sending with user authentication, or email sending and receiving using SSL/TLS.

1. Start your web browser.
2. Type "https://machine's IP address" in your browser's address bar (where "machine's IP address" is the machine's IP address).  
For example:  
https://192.168.1.2
3. If required, type the password in the **Login** field, and then click **Login**.



The default password to manage this machine's settings is located on the back of the machine and marked "Pwd".

4. Go to the navigation menu, and then click **Network > Network > Protocol**.



Start from , if the navigation menu is not shown on the left side of the screen.

5. In the **POP3/IMAP4/SMTP Client** field, click **Advanced Settings** and make sure the status of **POP3/IMAP4/SMTP Client** is **Enabled**.
6. Configure the **POP3/IMAP4/SMTP Client** settings.
  - Confirm that the email settings are correct after configuration by sending a test email.
  - If you do not know the POP3/IMAP4/SMTP server settings, contact your network administrator or Internet Service Provider (ISP).
7. When finished, click **Submit**.  
The **Test Send/Receive E-mail Configuration** dialog box appears.
8. Follow the instructions in the dialog box to test the current settings.



### Related Information

- [Send or Receive an Email Securely](#)



## Send an Email with User Authentication

Your machine supports the SMTP-AUTH method to send email via an email server that requires user authentication. This method prevents unauthorised users from accessing the email server.

You can use the SMTP-AUTH method for email notification, email reports and I-Fax.



---

We recommend using Web Based Management to configure the SMTP authentication.

---

### Email Server Settings

You must configure your machine's SMTP authentication method to match the method used by your email server. For details about your email server settings, contact your network administrator or Internet Service Provider (ISP).



---

To enable SMTP server authentication: in the Web Based Management **POP3/IMAP4/SMTP Client** screen, under **Server Authentication Method**, you must select **SMTP-AUTH**.

---



### Related Information

- [Send or Receive an Email Securely](#)
-

## Send or Receive an Email Securely Using SSL/TLS

Your machine supports SSL/TLS communication methods. To use an email server that is using SSL/TLS communication, you must configure the following settings.



We recommend using Web Based Management to configure SSL/TLS.

### Verify Server Certificate

Under **SSL/TLS**, if you choose **SSL** or **TLS**, the **Verify Server Certificate** checkbox will be selected automatically.



- Before you verify the server certificate, you must import the CA certificate issued by the CA that signed the server certificate. Contact your network administrator or your Internet Service Provider (ISP) to confirm if importing a CA certificate is necessary.
- If you do not need to verify the server certificate, clear the **Verify Server Certificate** checkbox.

### Port Number

If you select **SSL**, or **TLS**, the **Port** value will be changed to match the protocol. To change the port number manually, type the port number after you select **SSL/TLS** settings.

You must configure your machine's communication method to match the method used by your email server. For details about your email server settings, contact your network administrator or your ISP.

In most cases, the secured webmail services require the following settings:

|       |                                     |                  |
|-------|-------------------------------------|------------------|
| SMTP  | <b>Port</b>                         | 25               |
|       | <b>Server Authentication Method</b> | <b>SMTP-AUTH</b> |
|       | <b>SSL/TLS</b>                      | <b>TLS</b>       |
| POP3  | <b>Port</b>                         | 995              |
|       | <b>SSL/TLS</b>                      | <b>SSL</b>       |
| IMAP4 | <b>Port</b>                         | 993              |
|       | <b>SSL/TLS</b>                      | <b>SSL</b>       |



### Related Information

- [Send or Receive an Email Securely](#)

#### Related Topics:

- [Configure Certificates for Device Security](#)

## Store Print Log to Network

- [Store Print Log to Network Overview](#)
- [Configure the Store Print Log to Network Settings Using Web Based Management](#)
- [Use the Store Print Log to Network's Error Detection Setting](#)
- [Use Store Print Log to Network with Secure Function Lock 3.0](#)

## Store Print Log to Network Overview

The Store Print Log to Network feature allows you to save the print log file from your machine to a network server using the Common Internet File System (CIFS) protocol. You can record the ID, type of print job, job name, user name, date, time and the number of printed pages for every print job. CIFS is a protocol that runs over TCP/IP, allowing computers on a network to share files over an intranet or the Internet.

The following print functions are recorded in the print log:

- Print jobs from your computer
- USB Direct Print
- Copy
- Received Fax (supported models only)
- Web Connect Print (supported models only)



- The Store Print Log to Network feature supports Kerberos authentication and NTLMv2 authentication. You must configure the SNTP protocol (network time server), or you must set the date, time and time zone correctly on the control panel for authentication.
- You can set the file type to TXT or CSV when storing a file to the server.



### Related Information

- [Store Print Log to Network](#)

## Configure the Store Print Log to Network Settings Using Web Based Management

1. Start your web browser.
2. Type "https://machine's IP address" in your browser's address bar (where "machine's IP address" is the machine's IP address).

For example:

https://192.168.1.2

3. If required, type the password in the **Login** field, and then click **Login**.





The default password to manage this machine's settings is located on the back of the machine and marked "Pwd".

4. Go to the navigation menu, and then click **Administrator > Store Print Log to Network**.



Start from , if the navigation menu is not shown on the left side of the screen.

5. In the **Print Log** field, click **On**.
6. Configure the following settings:

| Option                     | Description  |
|----------------------------|--|
| <b>Network Folder Path</b> | Type the destination folder where your print log will be stored on the CIFS server (for example, \\ComputerName\SharedFolder).   |
| <b>File Name</b>           | Type the file name you want to use for the print log (up to 32 characters).  |
| <b>File Type</b>           | Select the <b>TXT</b> or <b>CSV</b> option for the Print Log file type.  |
| <b>Time Source for Log</b> | Select the time source for the print log.  |
| <b>Auth. Method</b>        | <p>Select the authentication method required for access to the CIFS server: <b>Auto</b>, <b>Kerberos</b>, or <b>NTLMv2</b>. Kerberos is an authentication protocol which allows devices or individuals to securely prove their identity to network servers using a single sign-on. NTLMv2 is the authentication method used by Windows to log into servers.</p> <ul style="list-style-type: none"><li>• <b>Auto</b>: If you select <b>Auto</b>, NTLMv2 will be used to the authentication method.</li><li>• <b>Kerberos</b>: Select the <b>Kerberos</b> option to use Kerberos authentication only.</li><li>• <b>NTLMv2</b>: Select the <b>NTLMv2</b> option to use NTLMv2 authentication only.</li></ul> <p> For the <b>Kerberos</b> and <b>NTLMv2</b> authentication, you must also configure the <b>Date&amp;Time</b> settings or the SNTP protocol (network time server) and DNS server.</p> <ul style="list-style-type: none"><li>• You can also configure the <b>Date &amp; Time</b> settings from the machine's control panel.</li></ul> |
| <b>Username</b>            | Type the user name for the authentication (up to 96 characters).   |
|                            | <p> If the user name is part of a domain, enter the user name in one of the following styles: user@domain or domain\user.</p>   |
| <b>Password</b>            | Type the password for the authentication (up to 32 characters).  |

---

| Option  | Description   |
|---|---|
| <b>Kerberos Server Address</b><br>(if needed) | Type the Key Distribution Center (KDC) host address (for example: kerberos.example.com; up to 64 characters) or the IP address (for example: 192.168.56.189). |
| <b>Error Detection Setting</b>                | Choose what action should be taken when the Print Log cannot be stored to the server due to a network error.  |

7. In the **Connection Status** field, confirm the last log status.



You can also confirm the error status on the LCD of your machine.

8. Click **Submit** to display the **Test Print Log to Network** page.

To test your settings, click **Yes** and then go to the next step.

To skip the test, click **No**. Your settings will be submitted automatically.

9. The machine will test your settings.

10. If your settings are accepted, **Test OK** appears on the screen.

If **Test Error** appears, check all settings, and then click **Submit** to display the Test page again.



### Related Information

- [Store Print Log to Network](#)
-

## Use the Store Print Log to Network's Error Detection Setting

Use Error Detection Settings to determine the action that is taken when the print log cannot be stored to the server due to a network error.

1. Start your web browser.
2. Type "https://machine's IP address" in your browser's address bar (where "machine's IP address" is the machine's IP address).

For example:

https://192.168.1.2

3. If required, type the password in the **Login** field, and then click **Login**.



The default password to manage this machine's settings is located on the back of the machine and marked "Pwd".

4. Go to the navigation menu, and then click **Administrator > Store Print Log to Network**.



Start from , if the navigation menu is not shown on the left side of the screen.

5. In the **Error Detection Setting** section, select the **Cancel Print** or **Ignore Log & Print** option.

| Option                        | Description   |
|-------------------------------|---|
| <b>Cancel Print</b>           | <p>If you select the <b>Cancel Print</b> option, the print jobs are cancelled when the print log cannot be stored to the server.</p> <p> Even if you select the <b>Cancel Print</b> option, your machine will print a received fax.</p>  |
| <b>Ignore Log &amp; Print</b> | <p>If you select the <b>Ignore Log &amp; Print</b> option, the machine prints the documentation even if the print log cannot be stored to the server.</p> <p>When the store print log function has recovered, the print log is recorded as follows:</p> <pre>[Id,Type,Job Name,User Name,Date,Time,Print Pages,Color Pages 1,Print(USB),"test(PDF).pdf","User",11/11/2020,19:53:14,4,0 2,Print(Network),"test(PDF).pdf","User",11/11/2020,19:54:38,4,0 3,Print(Network),"test(PDF).pdf","User",11/11/2020,20:18:57,?,? — a 4,Print(Network),"test(PDF).pdf","User",11/11/2020,20:19:40,1,0 5,&lt;ERROR&gt;?,?,?,?,?,? — b 6,Print(Network),"test(PDF).pdf","User",11/11/2020,20:21:04,1,0</pre> <p>a. If the log cannot be stored at the end of printing, the print log except the number of printed pages will be recorded.</p> <p>b. If the print log cannot be stored at the beginning and the end of printing, the print log of the job will not be recorded. When the function has recovered, the error is reflected in the log.</p> |

6. Click **Submit** to display the **Test Print Log to Network** page.

To test your settings, click **Yes** and then go to the next step.

To skip the test, click **No**. Your settings will be submitted automatically.

7. The machine will test your settings.

8. If your settings are accepted, **Test OK** appears on the screen.

If **Test Error** appears, check all settings, and then click **Submit** to display the Test page again.



## Related Information

- [Store Print Log to Network](#)
-



## Use Store Print Log to Network with Secure Function Lock 3.0

When Secure Function Lock 3.0 is active, the names of the registered users for copy, Fax RX, Web Connect Print and USB Direct Print (if available) are recorded in the Store Print Log to Network report. When the Active Directory Authentication is enabled, logged on user name will be recorded in the Store Print Log to Network report:

```
Id, Type, Job Name, User Name, Date, Time, Print Pages, Color Pages
1, Copy, -, -, 04/04/20xx, 09:05:12, 3, 3
2, Fax, -, -, 04/04/20xx, 09:45:30, 5, 0
3, Copy, -, "BOB", 04/04/20xx, 10:20:30, 4, 0
4, Fax, -, "BOB", 04/04/20xx, 10:35:12, 3, 0
5, USB Direct, -, "JOHN", 04/04/20xx, 11:15:43, 6, 6
```



### Related Information

- [Store Print Log to Network](#)

## Lock the Machine Settings from the Control Panel

Before turning on the machine's Setting Lock, make a careful note of your password. If you forget the password, you must reset all passwords stored in the machine by contacting your administrator or Brother customer service.

- [Setting Lock Overview](#)

## Setting Lock Overview

Use the Setting Lock feature to block unauthorised access to machine settings.

When Setting Lock is set to On, you cannot access the machine settings without entering the password.

- [Set the Setting Lock Password](#)
- [Change the Setting Lock Password](#)
- [Turn Setting Lock On](#)
- [Restrict Specific Machine Settings](#)

## Set the Setting Lock Password

1. Press  [Admin Settings] > [Password].



This password is also valid for other [Admin Settings] features and Web Based Management login.



2. Type the password you want to use. (8 to 32 characters), and then press [OK].
3. When the LCD displays [Verify], retype the password, and then press [OK].
4. When the machine prompts you to select next step, choose your selection.
5. Press .



### Related Information

- [Setting Lock Overview](#)

## Change the Setting Lock Password

1. Press  [Admin Settings].
2. Type the current password, and then press [OK].
3. Press [Password].
4. Type the current password again, and then press [OK].
5. Type a new password you want to use (8 to 32 characters), and then press [OK].
6. When the LCD displays [Verify], retype the password, and then press [OK].
7. Press .

### Related Information

- [Setting Lock Overview](#)

## Turn Setting Lock On

1. Press  [Admin Settings].
2. Type the current password, and then press [OK].
3. Press [Restriction Management] > [Setting Lock] > [On].
4. When the machine prompts you to select the next step, select the options you want, and then press [OK].



To turn Setting Lock off, repeat the step 1 and 2, and then press [Restriction Management] > [Setting Lock] > [Off].



5. Press .



### Related Information

- [Setting Lock Overview](#)

## Restrict Specific Machine Settings

1. Press  [Admin Settings].
2. Enter the current Administrator password, and then press [OK].
3. Press [Restriction Management] > [Setting Lock Details].
4. Choose the machine settings you want to restrict, and then press [OK].
5. Press .

### Related Information

- [Setting Lock Overview](#)

## Administrator

- [Network Features](#)
- [Security Features](#)
- [Brother Management Tools](#)



## Network Features

- [Change Machine Settings Using Web Based Management](#)
- [Print the Network Configuration Report](#)
- [Synchronise Time with the SNTP Server Using Web Based Management](#)
- [Store Print Log to Network](#)

## Security Features

Your machine uses some of the latest network security and encryption protocols. These network features can be integrated into your overall network security plan to help protect your data and prevent unauthorised access to the machine.

- [Network Security](#)
- [User Authentication](#)

## Network Security

- [Disable Unnecessary Protocols](#)
- [Configure Certificates for Device Security](#)
- [Use SSL/TLS](#)
- [Use SNMPv3](#)
- [Use IPsec](#)
- [Use IEEE 802.1x Authentication for a Wired or a Wireless Network](#)

## Disable Unnecessary Protocols

1. Start your web browser.
2. Type "https://machine's IP address" in your browser's address bar (where "machine's IP address" is the machine's IP address).

For example:

https://192.168.1.2

3. If required, type the password in the **Login** field, and then click **Login**.



---

The default password to manage this machine's settings is located on the back of the machine and marked "Pwd".

---

4. Go to the navigation menu, and then click **Network > Network > Protocol**.



---

Start from ☰, if the navigation menu is not shown on the left side of the screen.

---

5. Clear any unnecessary protocol checkboxes to disable them.
6. Click **Submit**.
7. Click **Yes** to restart your Brother machine and activate the configuration.



### Related Information

- [Network Security](#)

## User Authentication

- [Use Active Directory Authentication](#)
- [Use LDAP Authentication](#)
- [Use Secure Function Lock 3.0](#)

## Brother Management Tools

Use one of Brother's management tools to configure your Brother machine's network settings.  
Go to your model's **Downloads** page at [support.brother.com](http://support.brother.com) to download the tools.



### Related Information

- [Administrator](#)
-

## Mobile/Web Connect

- [Brother Web Connect](#)
- [AirPrint](#)
- [Mopria® Print Service](#)
- [Brother Mobile Connect](#)
- [Register an External IC Card Reader](#)

## Brother Web Connect

- [Brother Web Connect Overview](#)
- [Online Services Used with Brother Web Connect](#)
- [Set Up Brother Web Connect](#)
- [Scan and Upload Documents Using Brother Web Connect](#)
- [Download and Print Documents Using Brother Web Connect](#)
- [FaxForward to Cloud or E-mail](#)



## Brother Web Connect Overview

Certain websites provide services that allow users to upload and view images and files on the websites. Your Brother machine can scan images and upload them to these services, and also download and print images that are already uploaded to these services.

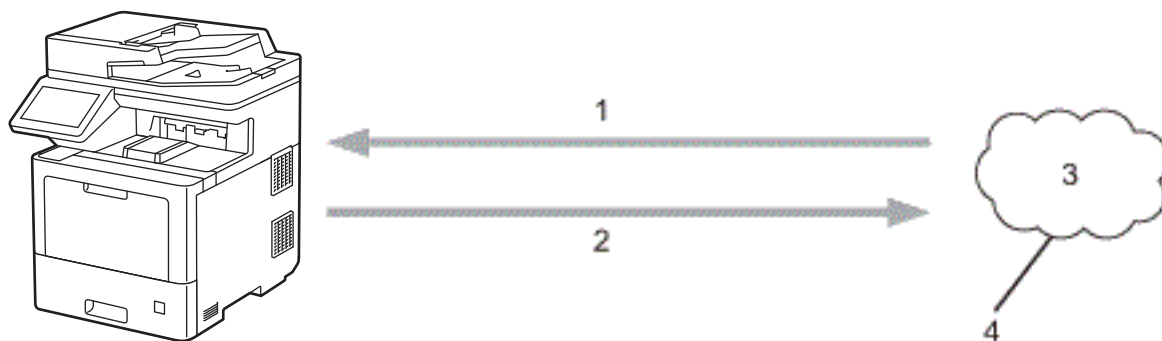

1. Printing
2. Scanning
3. Photos, images, documents, and other files
4. Web Service

To use Brother Web Connect, your Brother machine must be connected to a network that has access to the Internet, through either a wired or wireless connection.

For network setups that use a proxy server, the machine must also be configured to use a proxy server. If you are unsure of your network configuration, check with your network administrator.



A proxy server is a computer that serves as an intermediary between computers without a direct Internet connection, and the Internet.

### ✓ Related Information

- [Brother Web Connect](#)
  - [Configure the Proxy Server Settings Using the Machine's Control Panel](#)
  - [Configure the Proxy Server Settings Using Web Based Management](#)

## Configure the Proxy Server Settings Using the Machine's Control Panel

If your network uses a proxy server, the following proxy server information must be configured on the machine:

- Proxy server address
- Port number
- User Name
- Password

1. Press  [Settings] > [All Settings] > [Network] > [Web Connect Settings] > [Proxy Settings] > [Proxy Connection] > [On].



If your machine displays the [All Settings] menu on the Home screen, skip the [Settings] menu.

2. Press the option that you want to set, and then enter the proxy server information.
3. Press [OK].
4. Press .



### Related Information

- [Brother Web Connect Overview](#)

## Configure the Proxy Server Settings Using Web Based Management

If your network uses a proxy server, the following proxy server information must be configured using Web Based Management:

- Proxy server address
- Port number
- User Name
- Password



We recommend Microsoft Internet Explorer 11/Microsoft Edge for Windows, Safari 12/13 for Mac, Google Chrome™ for Android (4.x or later), and Google Chrome™/Safari for iOS (10.x or later). Make sure that JavaScript and Cookies are always enabled in whichever browser you use.

1. Start your web browser.
2. Type "https://machine's IP address" in your browser's address bar (where "machine's IP address" is the machine's IP address).

For example:

https://192.168.1.2

3. If required, type the password in the **Login** field, and then click **Login**.



The default password to manage this machine's settings is located on the back of the machine and marked "Pwd".

4. Go to the navigation menu, and then click **Network > Network > Protocol**.



Start from , if the navigation menu is not shown on the left side of the screen.

5. Make sure the **Proxy** checkbox is selected, and then click **Submit**.
6. In the **Proxy** field, click **Advanced Settings**.
7. Enter the proxy server information.
8. Click **Submit**.



### Related Information

- [Brother Web Connect Overview](#)

## Online Services Used with Brother Web Connect

Use Brother Web Connect to access services from your Brother machine:

To use Brother Web Connect, you must have an account with the online service you want to use. If you do not already have an account, use a computer to access the service's website and create an account.

You do not need to create an account to use Brother Creative Center.

### Google Drive™

An online document storage, editing, sharing, and file synchronisation service.

URL: [drive.google.com](http://drive.google.com)

### Evernote®

An online file storage and management service.

URL: [www.evernote.com](http://www.evernote.com)

### Dropbox

An online file storage, sharing, and synchronisation service.

URL: [www.dropbox.com](http://www.dropbox.com)

### OneDrive

An online file storage, sharing, and managing service.

URL: [onedrive.live.com](http://onedrive.live.com)

### Box

An online document editing and sharing service.

URL: [www.box.com](http://www.box.com)

### OneNote

An online document editing and sharing service.

URL: [www.onenote.com](http://www.onenote.com)

### Brother Creative Center

A website that offers various templates, such as greeting cards, brochures and calendars that you can print on your Brother machine (available only for certain countries).

<https://www.creativecenter.brother/>

For more information about any of these services, refer to the respective service's website.

The following table describes which file types can be used with each Brother Web Connect feature:

| Accessible Services            | Google Drive™<br>Evernote®<br>Dropbox<br>OneDrive<br>Box<br>OneNote | Brother Creative Center |
|--------------------------------|---|-------------------------|
| Download and print images<br>1 | JPEG<br>PDF<br>DOCX<br>XLSX<br>PPTX                                 | (Print only)            |
| Upload scanned images          | JPEG<br>PDF 2<br>DOCX   | -                       |

| Accessible Services  | Google Drive™<br>Evernote®<br>Dropbox<br>OneDrive<br>Box<br>OneNote | Brother Creative Center |
|--|---|-------------------------|
|  | XLSX<br>PPTX<br>TIFF<br>XPS   |                         |
| FaxForward to the online services<br>(available only for certain models) | JPEG<br>PDF<br>TIFF   | -                       |

1 DOC/XLS/PPT formats are also available for downloading and printing images.

2 For uploading scanned images, PDF includes Searchable PDF, Signed PDF, Secure PDF, PDF/A and High Compression PDF.



(For Hong Kong, Taiwan and Korea)

Brother Web Connect supports only file names written in English. Files named in the local language will not be downloaded.



## Related Information

- [Brother Web Connect](#)

## Set Up Brother Web Connect

- [Brother Web Connect Setup Overview](#)
- [Create an Account for Each Online Service Before Using Brother Web Connect](#)
- [Apply for Brother Web Connect Access](#)
- [Register an Account on Your Brother Machine for Brother Web Connect](#)
- [Set Up Brother Web Connect for Brother CreativeCenter](#)

## Brother Web Connect Setup Overview

Configure the Brother Web Connect settings using the following procedure (when using Brother CreativeCenter, this procedure is not necessary):

### Step 1: Create an account with the service you want to use.

Access the service's website using a computer and create an account. (If you already have an account, there is no need to create an additional account.)

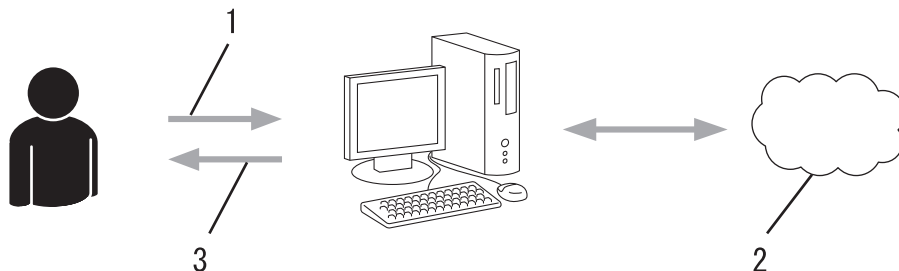

1. User registration
2. Web Service
3. Obtain account

### Step 2: Apply for Brother Web Connect access.

Start Brother Web Connect access using a computer and obtain a temporary ID.

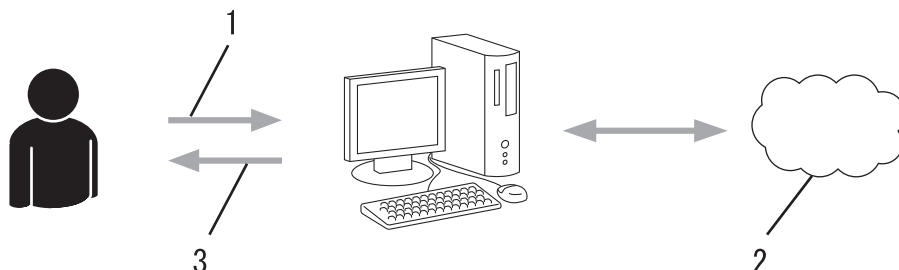

1. Enter account information
2. Brother Web Connect application page
3. Obtain temporary ID

### Step 3: Register your account information on your machine so you can access the service you want to use.

Enter the temporary ID to enable the service on your machine. Specify the account name as you would like it to be displayed on the machine, and enter a PIN if you would like to use one.

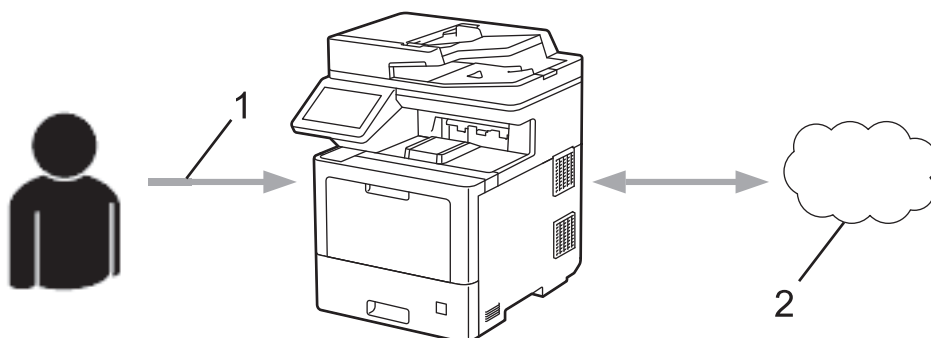

1. Enter temporary ID
2. Web Service

Your Brother machine can now use the service.



## Related Information

- [Set Up Brother Web Connect](#)
-



## Create an Account for Each Online Service Before Using Brother Web Connect

To use Brother Web Connect to access an online service, you must have an account with that online service. If you do not already have an account, use a computer to access the service's website and create an account. After creating an account, log on and use the account once with a computer before using the Brother Web Connect feature. Otherwise, you may not be able to access the service using Brother Web Connect.

If you already have an account, there is no need to create an additional account.

After you finish creating an account with the online service you want to use, apply for Brother Web Connect access.





### Related Information

- [Set Up Brother Web Connect](#)
-

## Apply for Brother Web Connect Access

To use Brother Web Connect to access online services, you must first apply for Brother Web Connect access using a computer that has the Brother Software installed.

1. Access the Brother Web Connect application website:

| Option  | Description  |
|---------|--|
| Windows | Launch  ( <b>Brother Utilities</b> ), and then click the drop-down list and select your model name (if not already selected).<br>Click <b>Do More</b> in the left navigation bar, and then click <b>Brother Web Connect</b> . |
|         |  You can also access the website directly:<br>Type <a href="http://bwc.brother.com">bwc.brother.com</a> into your web browser's address bar.  |
| Mac     | Type <a href="http://bwc.brother.com">bwc.brother.com</a> into your web browser's address bar.   |

The Brother Web Connect page launches.

2. Select the service you want to use.
3. Follow the on-screen instructions and apply for access.

When finished, your temporary ID appears.

Get connected with Brother Web Connect

### Finished the registration.

Please enter the following temporary ID on the LCD screen of your machine.

**Temporary ID (11 digits)**

**XXX XXXX XXXX**

NOTE : The temporary ID will expire in 24 hours.

4. Make a note of your temporary ID as you will need it to register accounts to the machine. The temporary ID is valid for 24 hours.
5. Close the web browser.

Now that you have a Brother Web Connect access ID, you must register this ID on your machine, and then use your machine to access the web service you want to use.

### Related Information

- [Set Up Brother Web Connect](#)

#### Related Topics:

- [Register an Account on Your Brother Machine for Brother Web Connect](#)

## Register an Account on Your Brother Machine for Brother Web Connect

You must enter your Brother Web Connect account information and configure your machine so that it can use Brother Web Connect to access the service you want.

- You must apply for Brother Web Connect access to register an account on your machine.
- Before you register an account, confirm that the correct date and time are set on the machine.

1. Swipe to display the [Web] option.
2. Press [Web].



- If information regarding the Internet connection appears on the machine's LCD, read the information and press [OK]. If you want to display this information again, press [Yes].
- Occasionally, updates or announcements about Brother Web Connect's features will appear on the LCD. Read the information, and then press [OK].

3. If the information regarding licence agreement appears, make your selection and follow the on-screen instructions.
4. Select the service with which you want to register.
5. Press the service name.
6. If information regarding Brother Web Connect appears, press [OK].
7. Press [Register/Delete Account].
8. Press [Register Account].  
The machine will prompt you to enter the temporary ID you received when you applied for Brother Web Connect access.
9. Press [OK].
10. Enter the temporary ID using the LCD.
11. Press [OK].



An error message will appear on the LCD if the information you entered does not match the temporary ID you received when you applied for access, or if the temporary ID has expired. Enter the temporary ID correctly, or apply for access again to receive a new temporary ID.

The machine will prompt you to enter the account name that you want displayed on the LCD.

12. Press [OK].
13. Enter the name using the LCD.
14. Press [OK].
15. Do one of the following:
  - To set a PIN for the account, press [Yes]. (A PIN prevents unauthorised access to the account.) Enter a four-digit number, and then press [OK].
  - If you do not want to set a PIN, press [No].
16. When the account information you entered appears, confirm that it is correct.
17. Press [Yes] to register your information as entered.
18. Press [OK].
19. Press .

Registration is complete and your machine can now access the service.



## Related Information

- [Set Up Brother Web Connect](#)

### **Related Topics:**

- [Apply for Brother Web Connect Access](#)
-

## Set Up Brother Web Connect for Brother CreativeCenter

Brother Web Connect is set up to work with Brother CreativeCenter automatically. No configuration is needed to create the calendars, business cards, posters and greeting cards available at <https://www.creativecenter.brother/>.



Brother CreativeCenter is not available in all countries.



### Related Information

- [Set Up Brother Web Connect](#)
-

## Scan and Upload Documents Using Brother Web Connect

Upload your scanned photos and documents directly to a web service without using a computer.

Uploaded documents are saved in an album named **From\_BrotherDevice**.

For information regarding restrictions, such as the size or number of documents that can be uploaded, refer to the respective service's website.

If you are a restricted Web Connect user due to the Secure Function Lock feature (available for certain models), you cannot upload the scanned data.

1. Load your document.
2. Swipe to display the [Web] option.
3. Press [Web].



- You can also press [Scan] > [to Web].
- If information regarding the Internet connection appears on the machine's LCD, read the information and press [OK]. If you want to display this information again, press [Yes].
- Occasionally, updates or announcements about Brother Web Connect's features will appear on the LCD. Read the information, and then press [OK].

4. Select the service that hosts the account to which you want to upload.
5. Select your account name.
6. Follow the on-screen instructions to complete this operation.



### Related Information

- [Brother Web Connect](#)

## Download and Print Documents Using Brother Web Connect

Documents that have been uploaded to your account can be downloaded directly to your machine and printed. Documents that other users have uploaded to their own accounts for sharing can also be downloaded to your machine and printed, as long as you have viewing privileges for those documents.

To download other users' documents, you must have access privileges to view the corresponding albums or documents.

If you are a restricted user for Web Connect due to the Secure Function Lock feature (available for certain models), you cannot download the data.

The Secure Function Lock Page Limit feature applies to the print job using Web Connect.



---

For Hong Kong, Taiwan and Korea:

Brother Web Connect supports only file names written in English. Files named in the local language will not be downloaded.

---



### Related Information

- [Brother Web Connect](#)
    - [Download and Print Using Web Services](#)
    - [Download and Print Brother CreativeCenter Templates](#)
-

## Download and Print Using Web Services

For information on Brother CreativeCenter Templates, see *Related Information*.

1. Swipe to display the [Web] option.
2. Press [Web].



- If information regarding the Internet connection appears on the machine's LCD, read the information and press [OK]. If you want to display this information again, press [Yes].
- Occasionally, updates or announcements about Brother Web Connect's features will appear on the LCD. Read the information, and then press [OK].

3. Select the service that hosts the document you want to download and print.
4. Select your account name. If the PIN entry screen appears, enter the four-digit PIN and press [OK].
5. Press [Download to Print].
6. Select the album you want. Some services do not require documents to be saved in albums. For documents not saved in albums, select [Show Unsorted Photos] or [Show Unsorted Files] to select documents.



An album is a collection of images. The actual term may differ depending on the service you use. When using Evernote®, you must select the notebook, and then select the note.

7. Select the thumbnail of the document you want to print. Confirm the document on the LCD and then press [OK]. Select additional documents to print (you can select up to 10 documents).
8. When finished, press [OK].
9. Follow the on-screen instructions to complete this operation.



### Related Information

- [Download and Print Documents Using Brother Web Connect](#)

#### Related Topics:

- [Download and Print Brother CreativeCenter Templates](#)



## Download and Print Brother CreativeCenter Templates

Brother CreativeCenter is not available in all countries.

1. Swipe to display the [Apps] option.
2. Press [Apps].



- If information regarding the Internet connection appears on the machine's LCD, read the information and press [OK]. If you want to display this information again, press [Yes].
- Occasionally, updates or announcements about Brother Web Connect's features will appear on the LCD. Read the information, and then press [OK].

3. Press [Print "CreativeCenter" Templates].
4. Select the category you want.
5. Select the category you want again.
6. Select the file you want. Enter the number of copies you want to print and then press [OK]. Repeat this step until you have chosen all the files that you want to print.
7. After you have selected all of the files you want to print, press [OK].



If information regarding the recommended print settings appears on the machine's LCD, read the information and press [OK]. If you want to display this information again, press [Yes].

8. Follow the on-screen instructions to complete this operation.



### Related Information

- [Download and Print Documents Using Brother Web Connect](#)

#### Related Topics:

- [Download and Print Using Web Services](#)

## FaxForward to Cloud or E-mail

- Use the FaxForward to Cloud feature to automatically forward incoming faxes to your accounts with the available online services.

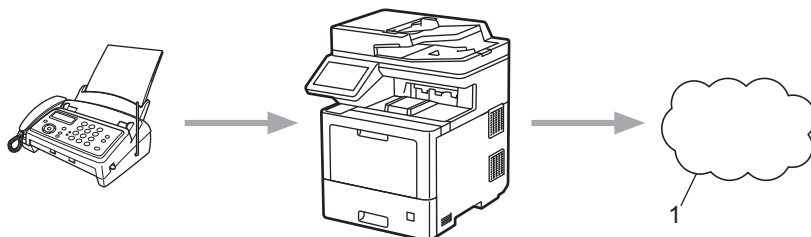

### 1. Web Service

- Use the FaxForward to E-mail feature to automatically forward incoming faxes to an inbox as email attachments.

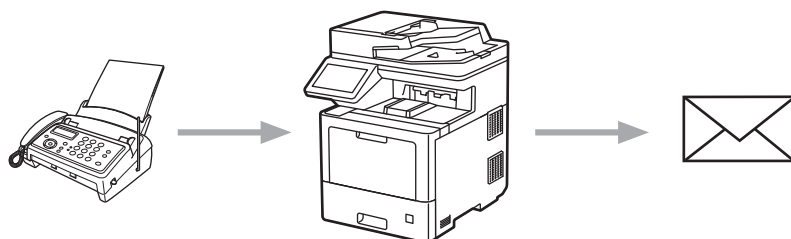

## ✓ Related Information

- [Brother Web Connect](#)
  - [Turn On FaxForward to Cloud or E-mail](#)
  - [Turn Off FaxForward to Cloud or E-mail](#)

## Turn On FaxForward to Cloud or E-mail

Turn on the FaxForward feature to automatically forward incoming faxes to either an online service or an inbox as email attachments.

- If you are a restricted Web Connect user due to the Secure Function Lock feature (available for certain models), you cannot upload the incoming faxes.
- This feature is available only for monochrome faxes.
- If you turn on the FaxForward to Cloud feature, you cannot use the following features:
  - [Fax Forward]
  - [Fax Storage]
  - [PC Fax Receive]

1. Swipe to display the [Apps] option.
2. Press [Apps].



- If information regarding the Internet connection appears on the machine's LCD, read the information and press [OK]. If you want to display this information again, press [Yes].
- Occasionally, updates or announcements about Brother Web Connect's features will appear on the LCD. Read the information, and then press [OK].

3. Select [FaxForward to Cloud/E-mail].



If information regarding [FaxForward to Cloud/E-mail] appears, read it, and then press [OK].

4. Press [On].
5. Press [Forward to Cloud] or [Forward to E-mail].
  - If you selected [Forward to Cloud], choose the online service you want to receive the faxes, and then specify your account name.
  - If you selected [Forward to E-mail], enter the email address you want to receive the faxes as email attachments.
6. Follow the on-screen instructions to complete this operation.



### Related Information

- [FaxForward to Cloud or E-mail](#)

## Turn Off FaxForward to Cloud or E-mail

Turn off FaxForward when you want to stop incoming faxes from automatically going to either an online service or an inbox as email attachments.

If there are received faxes still in your machine's memory, you cannot turn off the FaxForward to Cloud feature.

1. Swipe to display the [Apps] option.
2. Press [Apps].



- If information regarding the Internet connection appears on the machine's LCD, read the information and press [OK]. If you want to display this information again, press [Yes].
- Occasionally, updates or announcements about Brother Web Connect's features will appear on the LCD. Read the information, and then press [OK].

3. Select [FaxForward to Cloud/E-mail].



If information regarding [FaxForward to Cloud/E-mail] appears, read it, and then press [OK].

4. Press [Off].
5. Press [OK].



### Related Information

- [FaxForward to Cloud or E-mail](#)

## AirPrint

- [AirPrint Overview](#)
- [Before Using AirPrint \(macOS\)](#)
- [Print Using AirPrint](#)
- [Scan Using AirPrint \(macOS\)](#)
- [Send a Fax Using AirPrint \(macOS\)](#)

## AirPrint Overview

AirPrint is a printing solution for Apple operating systems that allows you to wirelessly print photos, email, web pages, and documents from your iPad, iPhone, iPod touch, and Mac computer without the need to install a driver.

AirPrint also lets you send faxes directly from your Mac computer without printing them and lets you scan documents to your Mac computer.

For more information, visit Apple's website.

Use of the Works with Apple badge means that an accessory has been designed to work specifically with the technology identified in the badge and has been certified by the developer to meet Apple performance standards.



### ✓ Related Information

- [AirPrint](#)

#### Related Topics:

- [AirPrint Problems](#)

## Before Using AirPrint (macOS)

Before printing using macOS, add your machine to the printer list on your Mac computer.

1. Select **System Preferences** from the Apple menu.
2. Click **Printers & Scanners**.
3. Click the + icon below the Printers pane on the left.  
The **Add** screen appears.
4. Select your machine, and then select **AirPrint** from the **Use** pop-up menu.
5. Click **Add**.



### Related Information

- [AirPrint](#)
-



## Print Using AirPrint

- [Print from iPad, iPhone, or iPod touch](#)
- [Print Using AirPrint \(macOS\)](#)



## Print from iPad, iPhone, or iPod touch

The procedure used to print may vary by application. Safari is used in the example below.

1. Make sure your machine is turned on.
2. Load the paper in the paper tray and change the paper tray settings on your machine, if necessary.
3. Use Safari to open the page that you want to print.
4. Tap  or .
5. Tap **Print**.
6. Make sure your machine is selected.
7. If a different machine (or no machine) is selected, tap **Printer**.  
A list of available machines appears.
8. Tap your machine's name in the list.
9. Select the options you want, such as the number of pages to print and 2-sided printing (if supported by your machine).
10. Tap **Print**.



### Related Information

- [Print Using AirPrint](#)

## Print Using AirPrint (macOS)

The procedure used to print may vary by application. Safari is used in the example below. Before printing, make sure your machine is in the printer list on your Mac computer.

1. Make sure your machine is turned on.
2. Load the paper in the paper tray and change the paper tray settings on your machine, if necessary.
3. On your Mac computer, use Safari to open the page that you want to print.
4. Click the **File** menu, and then select **Print**.
5. Make sure your machine is selected. If a different machine (or no machine) is selected, click the **Printer** pop-up menu, and then select your machine.
6. Select the desired options, such as the number of pages to print and 2-sided printing (if supported by your machine).
7. Click **Print**.



### Related Information

- [Print Using AirPrint](#)

#### Related Topics:

- [Before Using AirPrint \(macOS\)](#)

## Scan Using AirPrint (macOS)

Before scanning, make sure your machine is in the scanner list on your Mac computer.

1. Load your document.
2. Select **System Preferences** from the Apple menu.
3. Click **Printers & Scanners**.
4. Select your machine from the scanner list.
5. Click the **Scan** tab, and then click the **Open Scanner...** button.  
The Scanner screen appears.
6. If you place the document in the ADF, select **Use Document Feeder** checkbox, and then select the size of your document from the scan size setting pop-up menu.
7. Select the destination folder or destination application from the destination setting pop-up menu.
8. Click **Show Details** to change the scanning settings if needed.  
You can crop the image manually by dragging the mouse pointer over the portion you want to scan when scanning from the scanner glass.
9. Click **Scan**.



### Related Information

- [AirPrint](#)

#### Related Topics:

- [Before Using AirPrint \(macOS\)](#)

## Send a Fax Using AirPrint (macOS)

Make sure your machine is in the printer list on your Mac computer. Apple TextEdit is used in the example below.



AirPrint supports only monochrome fax documents.

1. Make sure your machine is turned on.
2. On your Mac computer, open the file that you want to send as a fax.
3. Click the **File** menu, and then select **Print**.
4. Click the **Printer** pop-up menu, and then select **Brother MFC-XXXX - Fax** (where XXX-XXXX is the name of your model).
5. Type the fax recipient information.
6. Click **Fax**.



### Related Information

- [AirPrint](#)

#### Related Topics:

- [Before Using AirPrint \(macOS\)](#)

## Mopria® Print Service

Mopria® Print Service is a print feature on Android™ mobile devices developed by the Mopria® Alliance. With this service, you can connect to the same network as your machine and print without additional setup.

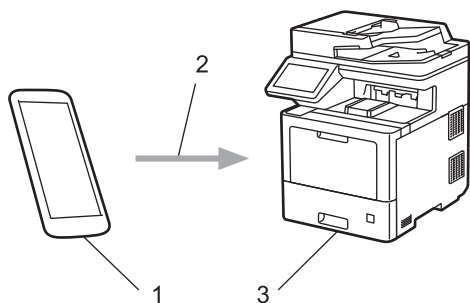

1. Android™ Mobile Device
2. Wi-Fi® Connection
3. Your Machine

You must download the Mopria® Print Service from Google Play™ and install it on your Android™ device.



### Related Information

- [Mobile/Web Connect](#)

## Brother Mobile Connect

Use Brother Mobile Connect to print and scan from your mobile device.

- For Android™ devices:

Brother Mobile Connect allows you to use your Brother machine's features directly from your Android™ device.

Download and install Brother Mobile Connect from Google Play™.

- For all iOS or iPadOS supported devices including iPhone, iPad, and iPod touch:

Brother Mobile Connect allows you to use your Brother machine's features directly from your iOS or iPadOS device.

Download and install Brother Mobile Connect from the App Store.



### Related Information

- [Mobile/Web Connect](#)

#### Related Topics:

- [Brother iPrint&Scan](#)
- [Access Brother iPrint&Scan \(Windows/Mac\)](#)

## Register an External IC Card Reader

When you connect an external IC card reader, use Web Based Management to register the card reader. Your machine supports HID class driver supported external IC card readers.

1. Start your web browser.
2. Type "https://machine's IP address" in your browser's address bar (where "machine's IP address" is the machine's IP address).

For example:

https://192.168.1.2

3. If required, type the password in the **Login** field, and then click **Login**.



The default password to manage this machine's settings is located on the back of the machine and marked "Pwd".

4. Go to the navigation menu, and then click **Administrator** > **External Card Reader**.



Start from , if the navigation menu is not shown on the left side of the screen.

5. Enter the necessary information.
6. Click **Submit**.
7. Click **Yes** to restart your Brother machine and activate the configuration.



### Related Information

- [Mobile/Web Connect](#)

## Brother iPrint&Scan

- [Access Brother iPrint&Scan \(Windows/Mac\)](#)
- [Scan Using Brother iPrint&Scan \(Windows/Mac\)](#)



## Access Brother iPrint&Scan (Windows/Mac)

Use Brother iPrint&Scan for Windows and Mac to print and scan from your computer.

The following screen shows an example of Brother iPrint&Scan for Windows. The actual screen may differ depending on the version of the application.

- For Windows  
Go to your model's **Downloads** page at [support.brother.com](http://support.brother.com) to download the latest application.
- For Mac  
Download and install Brother iPrint&Scan from the App Store.

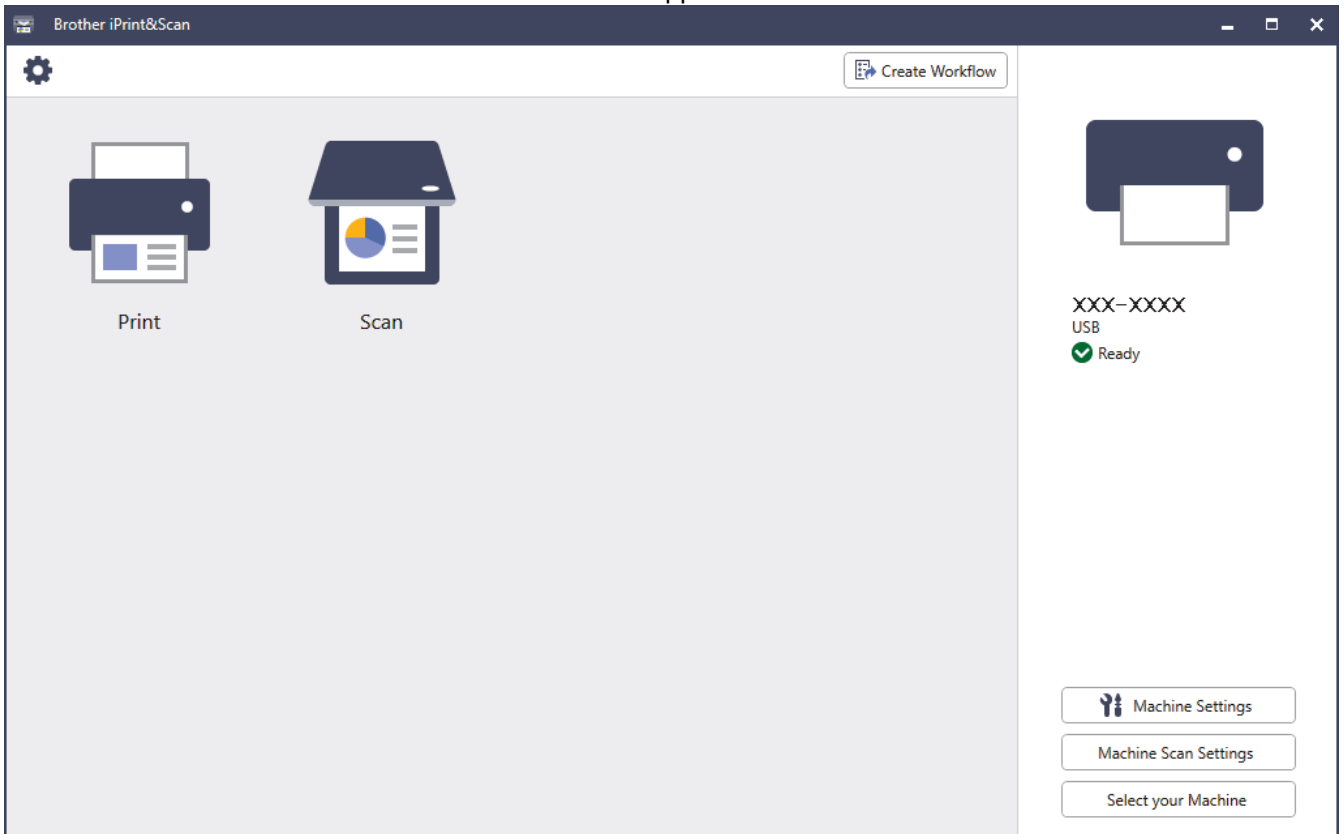

If prompted, install the driver and software necessary to use your machine. Download the installer from your model's **Downloads** page at [support.brother.com](http://support.brother.com).

### ✓ Related Information

- [Brother iPrint&Scan](#)

#### Related Topics:

- [Brother Mobile Connect](#)
- [Scan Using Brother iPrint&Scan \(Windows/Mac\)](#)

## Troubleshooting

Use this section to resolve typical problems you may encounter when using your machine. You can correct most problems yourself.

### IMPORTANT

For technical help, you must call Brother customer service or your local Brother dealer.

Using non-Brother supplies may affect the print quality, hardware performance, and machine reliability.



If you need additional help, visit [support.brother.com](http://support.brother.com).

First, check the following:

- The machine's power cord is connected correctly and the machine's power is on.
- All of the protective materials have been removed.
- Paper is loaded correctly in the paper tray.
- The interface cables are securely connected to the machine and the computer, or the wireless connection is set up on both the machine and your computer.
- Error and maintenance messages

If you did not solve the problem with the checks, identify the problem and then see *Related Information*.



### Related Information





- [Error and Maintenance Messages](#)
- [Error Messages When Using the Brother Web Connect Feature](#)
- [Document Jams](#)
- [Paper Jams](#)
- [Printing Problems](#)
- [Improve the Print Quality](#)
- [Telephone and Fax Problems](#)
- [Network Problems](#)
- [AirPrint Problems](#)
- [Other Problems](#)
- [Check the Machine Information](#)
- [Reset Your Machine](#)



## Error and Maintenance Messages

As with any sophisticated office product, errors may occur and supply items may have to be replaced. If this happens, your machine identifies the error or required routine maintenance and shows the appropriate message. The most common error and maintenance messages are shown in the table.

Follow the instructions in the **Action** column to solve the error and remove the message.





You can correct most errors and perform routine maintenance by yourself. If you need more tips: Visit [support.brother.com](http://support.brother.com), and click the **FAQs & Troubleshooting** page.

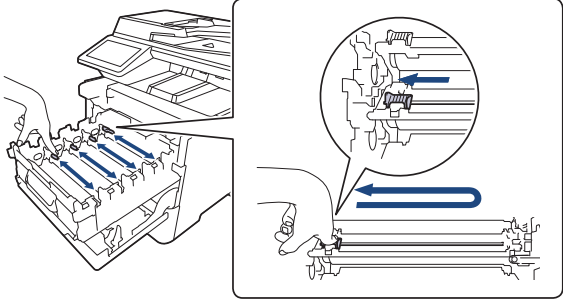

| Error Message                 | Cause   | Action   |
|-------------------------------|---|--|
| 2-sided Disabled              | The back cover of the machine is not closed completely.   | Close the back cover of the machine until it locks in the closed position.   |
| Access Denied                 | The function you want to use is restricted by Secure Function Lock 3.0.                         | Ask your administrator to check your Secure Function Lock Settings.  |
| Belt Error                    | The belt unit is not installed correctly.   | Remove the belt unit from your machine, and put the belt unit back into the machine.   |
| BT Call Sign On<br>(For U.K.) | The BT Call Sign setting is on. You cannot change the Receive Mode from Manual to another mode. | Set the BT Call Sign setting to off.   |
| Calibration                   | Calibration failed.   | <ul style="list-style-type: none"> <li>Press and hold down  to turn the machine off. Wait a few seconds, and then turn it on again. Perform the colour correction again using the LCD.</li> <li>Install a new belt unit.</li> <li>If the problem continues, contact Brother customer service or your local Brother dealer.</li> </ul> |
| Cannot Detect                 | Your machine cannot detect the toner cartridge for the colour indicated on the LCD.             | Remove the toner cartridge for the colour indicated on the LCD from the drum unit, and put the toner cartridge back into the drum unit.  |
|                               | Your machine cannot detect the belt unit.   | Remove the belt unit from your machine, and put the belt unit back into the machine.   |
|                               | Your machine cannot detect the drum unit.   | Remove the drum unit from your machine, and put the drum unit back into the machine.   |
| Cannot Print ##               | The machine has a mechanical problem.   | <ul style="list-style-type: none"> <li>Press and hold  to turn the machine off, wait a few minutes, and then turn it on again.</li> <li>If the problem continues, contact Brother customer service or your local Brother dealer.</li> </ul>   |
| Cannot Scan                   | The document is too long for 2-sided scanning.  | Press  . For 2-sided scanning, use A4 size paper. Other paper must be within the following size:<br>Length: 147.3 to 355.6 mm<br>Width: 105 to 215.9 mm  |
| Cannot Scan ##                | The machine has a mechanical problem.   | <ul style="list-style-type: none"> <li>Press and hold  to turn the machine off, and then turn it on again.</li> <li>If the problem continues, contact Brother customer service or your local Brother dealer.</li> </ul>   |

| Error Message   | Cause   | Action  |
|-----------------|---|---|
| Cartridge Error | The toner cartridge is not installed correctly.   | Pull out the drum unit, remove the toner cartridge for the colour that is indicated on the LCD, and place it back in the drum unit. Install the drum unit in the machine again.<br>If the problem continues, contact Brother customer service or your local Brother dealer. |
| Comm.Error      | Poor telephone line quality caused a communication error.   | Send the fax again or connect the machine to another telephone line. If the problem continues, contact the telephone company and ask them to check your telephone line.   |
| Condensation    | Condensation may have formed inside the machine after a room temperature change.  | Leave the machine turned on. Wait for 30 minutes with the front cover in the open position. Then turn off the machine and close the cover. Turn it on again.  |
| Cooling Down    | The temperature inside the machine is too high. The machine pauses its current print job and goes into cooling down mode. | Wait until the machine has finished cooling down. Make sure all vents on the machine are clear of obstructions.<br>When the machine has cooled down, it will resume printing.   |
| Cover is Open   | The front cover is not completely closed.   | Open and then firmly close the front cover of the machine.  |
| Cover is Open.  | The fuser cover is not completely closed or paper was jammed in the back of the machine when you turned on the power.     | Close the fuser cover located under the back cover of the machine.<br>Make sure paper is not jammed inside the back of the machine, and then close the fuser cover.   |
| Cover is Open.  | The ADF cover is not completely closed.   | Close the ADF cover.<br>If the error message remains, press  .   |
| Disconnected    | The other person or other person's fax machine stopped the call.  | Try to send or receive again.<br>If calls are stopped repeatedly and you are using a VoIP (Voice over IP) system, try changing the Compatibility to Basic (for VoIP).   |
| Document Jam    | The document was not inserted or fed correctly, or the document scanned from the ADF was too long.                        | Remove the jammed paper from the ADF unit.<br>Clear any debris or scraps of paper from the ADF unit paper path.<br>Press  .   |

| Error Message  | Cause   | Action   |
|--|---|--|
| Drum !   | The corona wires on the drum unit must be cleaned.  | <p>Clean the corona wires on the drum unit.</p>  <p>See <i>Related Information: Clean the Corona Wires.</i></p> <p>If the problem continues, replace the drum unit with a new one.</p> |
|  | The drum unit or the toner cartridge and drum unit assembly is not installed correctly.                     | Remove the drum unit, remove the toner cartridges from the drum unit, and put the toner cartridges back into the drum unit. Reinstall the drum unit in the machine.  |
| Drum Error   | The drum unit is not installed correctly.   | Remove the drum unit from your machine, and put the drum unit back into the machine.   |
| Drum Stop  | It is time to replace the drum unit.  | Replace the drum unit.<br>See <i>Related Information: Replace the Drum Unit.</i>   |
| Jam 2-sided  | The paper is jammed in the paper tray or the 2-sided tray.  | Remove the paper tray and the 2-sided tray, and remove all jammed paper as shown on the LCD.   |
| Jam Inside   | The paper is jammed inside the machine.   | Open the front cover, remove the toner cartridge and drum unit assembly, and pull out all jammed paper. Reinstall the toner cartridge and drum unit assembly into the machine. Close the front cover.  |
| Jam MP Tray  | The paper is jammed in the MP tray.   | Gently remove the jammed paper from in and around the MP tray. Reload the paper and press <b>Retry</b> .   |
| Jam Rear   | The paper is jammed in the back of the machine.   | Open the back cover, the fuser cover and the cover 2 (if equipped). Remove all jammed paper. Close the covers. Press <b>Retry</b> .  |
| Jam Tray 1<br>Jam Tray 2<br>Jam Tray 3<br>Jam Tray 4 | The paper is jammed in the indicated paper tray.  | Pull out the paper tray and remove all jammed paper as shown in the animation on the LCD.  |
| Limit Exceeded                                       | The print limit set in Secure Function Lock 3.0 was reached.  | Ask your administrator to check your Secure Function Lock Settings.  |
| Media Type Mismatch                                  | The media type specified in the printer driver differs from the paper type specified in the machine's menu. | Load the correct type of paper in the tray, and then select the correct media type in the Paper Type setting on the machine.   |
| No 2-sided Tray                                      | The 2-sided tray is not installed or not installed correctly.   | Reinstall the 2-sided tray.  |
| No Belt  | The belt unit is not installed or not installed correctly.  | Reinstall the belt unit.<br>See <i>Related Information: Replace the Belt Unit.</i>   |
| No Drum  | The drum unit is not installed or not installed correctly.  | Reinstall the toner cartridge and drum unit assembly.<br>See <i>Related Information: Replace the Drum Unit.</i>  |

| Error Message  | Cause  | Action   |
|--|--|--|
| No Drum Unit   | The drum unit is not installed correctly.  | Reinstall the toner cartridge and drum unit assembly.<br><i>See Related Information: Replace the Drum Unit.</i>  |
| No HUB Support   | A USB hub device is connected to the USB direct interface.   | Disconnect the USB hub device from the USB direct interface.   |
| No Paper   | The machine is out of paper, or paper is not loaded correctly in the paper tray.                     | <ul style="list-style-type: none"> <li>• Refill paper in the paper tray. Make sure the paper guides are set to the correct size.</li> <li>• If paper is in the tray, remove it and load it again. Make sure the paper guides are set to the correct size.</li> <li>• Do not overfill the paper tray.</li> </ul>  |
| No Paper Fed T1<br>No Paper Fed T2<br>No Paper Fed T3<br>No Paper Fed T4 | The machine failed to feed paper from the indicated paper tray.                                      | Pull out the paper tray indicated on the LCD and gently remove all jammed paper.   |
| No Paper MP Tray   | The MP tray is out of paper, or paper is not loaded correctly in the MP tray.                        | <p>Do one of the following:</p> <ul style="list-style-type: none"> <li>• Refill paper in the MP tray. Make sure the paper guides are set to the correct size.</li> <li>• If paper is in the MP tray, remove it and load it again. Make sure the paper guides are set to the correct size.</li> </ul>   |
| No Paper Tray 1<br>No Paper Tray 2<br>No Paper Tray 3<br>No Paper Tray 4 | The paper tray is out of paper, or paper is not loaded correctly in the paper tray.                  | <p>Do one of the following:</p> <ul style="list-style-type: none"> <li>• Refill paper in the paper tray indicated on the LCD. Make sure the paper guides are set to the correct size.</li> <li>• If paper is in the tray, remove it and load it again. Make sure the paper guides are set to the correct size.</li> <li>• Do not overfill the paper tray.</li> </ul> |
| No Response  | The connected USB device is unresponsive.  | Unplug the device from the USB direct interface.   |
| No Toner   | The toner cartridge for the colour indicated on the LCD is not installed or not installed correctly. | Remove the toner cartridge for the colour indicated on the LCD from the drum unit, and put the toner cartridge back into the drum unit. If the problem continues, replace the toner cartridge.<br><i>See Related Information: Replace the Toner Cartridge.</i>   |
| No Tray 1<br>No Tray 2<br>No Tray 3<br>No Tray 4                         | The paper tray is not installed or not installed correctly.  | Reinstall the paper tray indicated on the LCD.   |
| No Waste Toner   | The waste toner box is not installed or not installed correctly.                                     | Reinstall the waste toner box.<br><i>See Related Information: Replace the Waste Toner Box.</i>   |
| Out of Fax Memory  | The machine's fax memory is full.  | <p>If you are using the Fax Preview function, delete unwanted received fax data.</p> <p>If you are using the Memory Receive function and are not using the Fax Preview function, print received fax data.</p> <p><i>See Related Information: Print a Fax Stored in the Machine's Memory.</i></p>   |

| Error Message   | Cause  | Action  |
|---|--|---|
| Out of Memory   | The machine's memory is full.  | <p><b>If a fax-sending or copy operation is in progress, do one of the following:</b></p> <ul style="list-style-type: none"> <li>• Press <b>Send Now</b> to send the pages scanned so far.</li> <li>• Press <b>Partial Print</b> to copy the pages scanned so far.</li> <li>• Press <b>Quit</b> or  and wait until the other operations that are in progress finish, and then try again.</li> </ul> <p><b>If a scan operation is in progress, do one of the following:</b></p> <ul style="list-style-type: none"> <li>• Split the document into multiple parts.</li> <li>• Reduce the Resolution.</li> <li>• Reduce the File Size.</li> <li>• Select the high compression PDF file type.</li> <li>• Clear faxes from the memory.</li> </ul> <p>If a print operation is in progress, press  and reduce the print resolution.</p> |
| Output Tray Full  | The output paper tray is full.   | Remove printed paper from the face-down output tray.  |
| Paper Low<br>Paper Low T1<br>Paper Low T2<br>Paper Low T3<br>Paper Low T4 | The paper tray is nearly empty.  | Refill the paper in the paper tray indicated on the LCD.  |
| Print Data Full   | The machine's memory is full.  | Press  and delete the previously stored secure print data.  |
| Registration  | Registration failed.   | <ul style="list-style-type: none"> <li>• Press and hold down  to turn the machine off. Wait a few seconds, and then turn it on again. Perform the colour correction again using the LCD.</li> <li>• Install a new belt unit.</li> <li>• If the problem continues, contact Brother customer service or your local Brother dealer.</li> </ul>  |
| Replace Toner   | The toner cartridge is at the end of its life. The machine stops all print operations.<br>While memory is available, faxes are stored in the memory. | Replace the toner cartridge for the colour indicated on the LCD.<br><i>See Related Information: Replace the Toner Cartridge.</i>  |
| Replace WT Box  | It is time to replace the waste toner box.   | Replace the waste toner box with a new one.<br><i>See Related Information: Replace the Waste Toner Box.</i>   |
| Self-Diagnostic   | The temperature of the fuser unit does not rise to a specified temperature within the specified time.  | Press and hold  to turn the machine off, wait a few seconds, and then turn it on again. Leave the machine idle for 15 minutes with the power on.   |
|   | The fuser unit is too hot.   |   |
| Short paper   | The length of the paper in the tray is too short for the machine to deliver it to the Face down output tray.   | Open the back cover (Face up output tray) to let the printed page exit onto the Face up output tray. Remove the printed pages, and then press <b>Retry</b> .  |

| Error Message  | Cause   | Action   |
|--|---|--|
| Size Error   | The paper size defined in the printer driver is not supported by the defined tray.                            | Choose a paper size supported by the defined tray.   |
| Size Error 2-sided   | The paper size specified in the machine's paper size setting is not available for automatic 2-sided printing. | Press  (if required).<br>Load the correct size of paper in the tray and set the tray for that paper size.  |
|  | The paper in the tray is not the correct size and is not available for automatic 2-sided printing.            | Choose a paper size supported by 2-sided printing.<br>Paper sizes available for automatic 2-sided printing are A4, Letter, Legal, Mexico Legal, India Legal, and Folio.  |
| Size Mismatch  | The paper in the tray is not the correct size.  | Load the correct size of paper in the tray and set the size of paper for the tray.   |
| Storage device not recognized  | The USB flash drive is unavailable for use.   | Press <b>Close</b> , and then press and hold  to turn the machine off. Wait a few minutes, and then turn it on again. If the error message remains, change the Job Save Location setting to the machine's memory. |
| Storage Full   | The USB flash memory drive you are using does not have enough free space to store secure print data.          | Press  and delete the previously stored secure print data.   |
| Supplies<br>Belt End Soon  | The belt unit is near the end of its life.  | Order a new belt unit before the LCD displays <b>Replace Belt</b> .  |
| Supplies<br>Drum End Soon  | The drum unit is near the end of its life.  | Order a new drum unit before the LCD displays <b>Replace Drum</b> .  |
| Supplies<br>Replace Belt   | It is time to replace the belt unit.  | Replace the belt unit with a new one.<br><i>See Related Information: Replace the Belt Unit.</i>  |
| Supplies<br>Replace Drum   | It is time to replace the drum unit.  | Replace the drum unit.<br><i>See Related Information: Replace the Drum Unit.</i>   |
| Supplies<br>Toner Low: X<br>(X indicates the toner cartridge or drum unit colour that is near the end of its life. BK=Black, C=Cyan, M=Magenta, Y=Yellow.) | If the LCD displays this message, you can still print. The toner cartridge is near the end of its life.       | Order a new toner cartridge before the LCD displays <b>Replace Toner</b> .   |
| Supplies<br>WT Box End   | It is time to replace the waste toner box.  | Replace the waste toner box.<br><i>See Related Information: Replace the Waste Toner Box.</i>   |
| Supplies<br>WT Box End Soon  | The waste toner box is almost full.   | Order a new waste toner box before the LCD displays <b>Replace WT Box</b> .  |
| Toner Error  | One or more toner cartridges are not installed or not installed correctly.                                    | Remove the toner cartridge and drum unit assembly. Take out the toner cartridge, and put it back into the drum unit again. Re-install the toner cartridge and drum unit assembly back in the machine.  |



| Error Message   | Cause  | Action   |
|---|--|--|
| Touchscreen<br>Initialisation Failed  | The touchscreen was pressed before the power on initialisation was completed.  | Make sure nothing is touching the touchscreen.   |
|   | Debris may be stuck between the lower part of the touchscreen and its frame.   | Insert a piece of stiff paper between the lower part of the touchscreen and its frame and slide it back and forth to push out any debris.  |
| Tray 2 Error<br>Tray 3 Error  | The optional lower tray is not installed correctly.  | Reinstall the lower tray.  |
| Unusable Device   | A USB device or USB flash drive that is encrypted or not supported has been connected to the USB direct interface.                 | Unplug the device from the USB direct interface.   |
| Unusable Device<br>Remove the Device. Turn the power off and back on again.                                     | A defective USB device or a high power consumption USB device has been connected to the USB direct interface.                      | <ul style="list-style-type: none"> <li>Unplug the device from the USB direct interface.</li> <li>Press and hold  to turn the machine off, and then turn it on again.</li> </ul> |
| USB flash drive not detected  | A USB flash drive was not connected to the USB port (Rear).  | Connect a USB flash drive to the USB port (Rear).  |
| Wrong Belt  | The belt unit is not correct for your machine.   | Remove the belt unit, and put a belt unit with the correct supply model name.  |
| Wrong Drum  | The drum unit is not correct for your machine.   | Remove the drum unit, and put a drum unit with the correct supply model name.  |
| Wrong Paper Size MP<br>Wrong Paper Size T1<br>Wrong Paper Size T2<br>Wrong Paper Size T3<br>Wrong Paper Size T4 | The specified tray ran out of paper during copying and the machine could not feed the same size paper from the next priority tray. | Refill the paper in the paper tray.  |
| Wrong Toner Cartridge   | The toner cartridge for the colour indicated on the LCD is not the correct toner cartridge for your machine.                       | Remove the toner cartridge for the colour indicated on the LCD from the drum unit, and put a toner cartridge with the correct supply model name.   |



## Related Information

- [Troubleshooting](#)
  - [Transfer Your Faxes or Fax Journal Report](#)

### Related Topics:

- [Load and Print Using the Paper Tray](#)
- [Load and Print Using the Multi-purpose Tray \(MP Tray\)](#)
- [Replace Supplies](#)
- [Replace the Toner Cartridge](#)
- [Replace the Drum Unit](#)
- [Replace the Belt Unit](#)
- [Replace the Waste Toner Box](#)
- [Clean the Corona Wires](#)
- [Print a Fax Stored in the Machine's Memory](#)
- [Secure Print Using a USB Flash Drive](#)

## Transfer Your Faxes or Fax Journal Report

If the LCD displays:

- [Cannot Print] ##
- [Cannot Scan] ##

We recommend transferring your faxes to another fax machine or to your computer.

You can also transfer the Fax Journal report to see if there are any faxes you must transfer.



If there is an error message on the LCD after you transfer the faxes, disconnect your Brother machine from the power source for several minutes, and then reconnect it.



### Related Information

- [Error and Maintenance Messages](#)
  - [Transfer Faxes to Another Fax Machine](#)
  - [Transfer Faxes to Your Computer](#)
  - [Transfer the Fax Journal Report to Another Fax Machine](#)

## Transfer Faxes to Another Fax Machine

If you have not set up your Station ID, you cannot enter Fax Transfer mode.

1. Press  [Settings] > [All Settings] > [Service] > [Data Transfer] > [Fax Transfer].



If your machine displays the [All Settings] menu on the Home screen, skip the [Settings] menu.

2. Do one of the following:
  - If the LCD displays [No Data], there are no faxes left in the machine's memory. Press [Close].
  - Enter the fax number to which faxes will be forwarded.
3. Press [Fax Start].



### Related Information

- [Transfer Your Faxes or Fax Journal Report](#)

#### Related Topics:

- [Set Your Station ID](#)

## Transfer Faxes to Your Computer

1. Make sure you have installed the software and drivers on your computer, and then turn on PC-FAX Receive on the computer.

Do one of the following:

- (Windows 7)

From the  (**Start**) menu, select **All Programs > Brother > Brother Utilities**.

Click the drop-down list and select your model name (if not already selected). Click **PC-FAX** in the left navigation bar, and then click **Receive**.

- (Windows 8.1 and Windows 10)

Click  (**Brother Utilities**), and then click the drop-down list and select your model name (if not already selected). Click **PC-FAX** in the left navigation bar, and then click **Receive**.

2. Make sure you have set [PC Fax Receive] on the machine.

If faxes are in the machine's memory when you set up PC-Fax Receive, the LCD displays [Send Fax to PC?].

3. Do one of the following:

- To transfer all faxes to your computer, press [Yes].
- To exit and leave the faxes in the memory, press [No].

4. Press .

### Related Information

- [Transfer Your Faxes or Fax Journal Report](#)

## Transfer the Fax Journal Report to Another Fax Machine

If you have not set up your Station ID, you cannot enter fax transfer mode.

1. Press  [Settings] > [All Settings] > [Service] > [Data Transfer] > [Report Transfer].



If your machine displays the [All Settings] menu on the Home screen, skip the [Settings] menu.

2. Enter the fax number to which the Fax Journal will be forwarded.
3. Press [Fax Start].



### Related Information

- [Transfer Your Faxes or Fax Journal Report](#)

#### Related Topics:

- [Set Your Station ID](#)

## Error Messages When Using the Brother Web Connect Feature

Your machine displays an error message if an error occurs. The most common error messages are shown in the table.

You can correct most errors yourself. If, after reading this table, you still need help, see the latest troubleshooting tips at [support.brother.com](http://support.brother.com).

### Connection Error

| Error Messages   | Cause   | Action  |
|--|---|---|
| Connection Error 02<br>Network connection failed.<br>Verify that the network connection is good. | The machine is not connected to a network.  | <ul style="list-style-type: none"> <li>Make sure the eligible IP address is assigned to your machine.</li> <li>Check your access point/router is active and the Internet connection is established.</li> <li>Make sure the wireless router/access point is on.</li> <li>If the <b>Web</b> button was pressed soon after the machine was turned on, the network connection may not have been established yet. Wait and try again.</li> </ul> |
| Connection Error 03<br>Connection failed to server.<br>Check network settings.                   | <ul style="list-style-type: none"> <li>Network or server settings are incorrect.</li> <li>There is a problem with the network or server.</li> </ul> | <ul style="list-style-type: none"> <li>Confirm that network settings are correct, or wait and try again later.</li> <li>If the <b>Web</b> button was pressed soon after the machine was turned on, the network connection may not have been established yet. Wait and try again.</li> </ul> <p><i>See Related Information: Configure Date and Time Using Web Based Management.</i></p>  |
| Connection Error 07<br>Connection failed to server.<br>Wrong Date & Time.                        | Date and time settings are incorrect.   | Set the date and time correctly. Note that if the machine's power cord is disconnected, the date and time settings may have reset to factory settings.  |

### Authentication Error

| Error Messages  | Cause  | Action   |
|---|--|--|
| Authentication Error 01<br>Incorrect PIN code. Enter PIN correctly.   | The PIN you entered to access the account is incorrect. The PIN is the four-digit number that was entered when registering the account to the machine. | Enter the correct PIN.   |
| Authentication Error 02<br>Incorrect or expired ID, or this temporary ID is already used. Enter correctly or reissue temporary ID. Temporary ID is valid for 24 hours after it is issued. | The temporary ID that was entered is incorrect.  | Enter the correct temporary ID.  |
|   | The temporary ID that was entered has expired. A temporary ID is valid for 24 hours.   | Apply for Brother Web Connect access again and receive a new temporary ID, and then use the new ID to register the account to the machine. |
| Authentication Error 03   | The name you entered as the display name has already been registered to another service user.  | Enter a different display name.  |

| Error Messages  | Cause | Action |
|---|-------|--------|
| Display name has already been registered. Enter another display name. |       |        |

## Server Error

| Error Messages  | Cause  | Action   |
|---|--|--|
| Server Error 01<br>Authentication failed. Do the following: 1. Go to <a href="http://bwc.brother.com">http://bwc.brother.com</a> to get a new temporary ID. 2. Press OK and enter your new temporary ID in the next screen. | The machine's authentication information (needed to access the service) has expired or is invalid.   | Apply for Brother Web Connect access again to receive a new temporary ID, and then use the new ID to register the account to the machine.  |
| Server Error 03<br>Failed to upload.<br>Unsupported file or corrupt data. Confirm data of file.   | The file you are trying to upload may have one of the following problems: <ul style="list-style-type: none"> <li>The file exceeds the service's limit on number of pixels, file size, etc.</li> <li>The file type is not supported.</li> <li>The file is corrupted.</li> </ul> | <ul style="list-style-type: none"> <li>Check the service's size or format restrictions.</li> <li>Save the file as a different type.</li> <li>If possible, get a new, uncorrupted version of the file.</li> </ul> |
| Server Error 13<br>Service temporarily unavailable. Try again later.  | There is a problem with the service and it cannot be used now.   | Wait and try again. If you get the message again, access the service from a computer to confirm if it is unavailable.  |



### Related Information

- [Troubleshooting](#)

#### Related Topics:

- [Configure Date and Time Using Web Based Management](#)

## Document Jams

- [Document is Jammed in the Top of the ADF Unit](#)
- [Document is Jammed under the Document Cover](#)
- [Remove Small Scraps of Paper Jammed in the ADF](#)



## Document is Jammed in the Top of the ADF Unit

1. Remove any paper from the ADF that is not jammed.
2. Open the ADF cover.
3. Pull the jammed document out to the left. If the document rips or tears, be sure you remove any debris or scraps to prevent future jams.

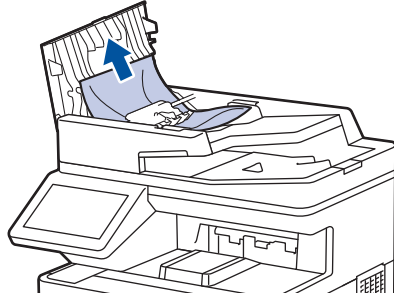

4. Close the ADF cover.

5. Press .





### Related Information

- [Document Jams](#)

## Document is Jammed under the Document Cover

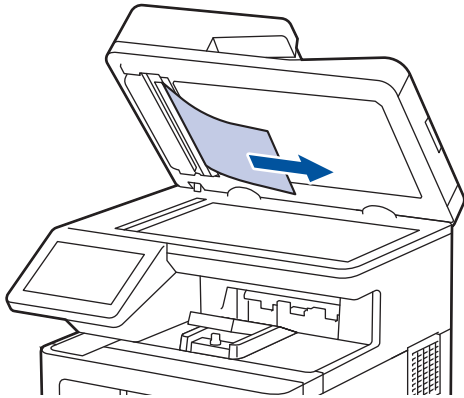
1. Remove any paper from the ADF that is not jammed.
2. Lift the document cover.
3. Pull the jammed document out to the right. If the document rips or tears, be sure you remove any debris or scraps to prevent future jams.



4. Close the document cover.
5. Press .

### Related Information

- [Document Jams](#)

## Remove Small Scraps of Paper Jammed in the ADF

1. Lift the document cover.
2. Insert a piece of stiff paper, such as cardstock, into the ADF to push any small paper scraps through.

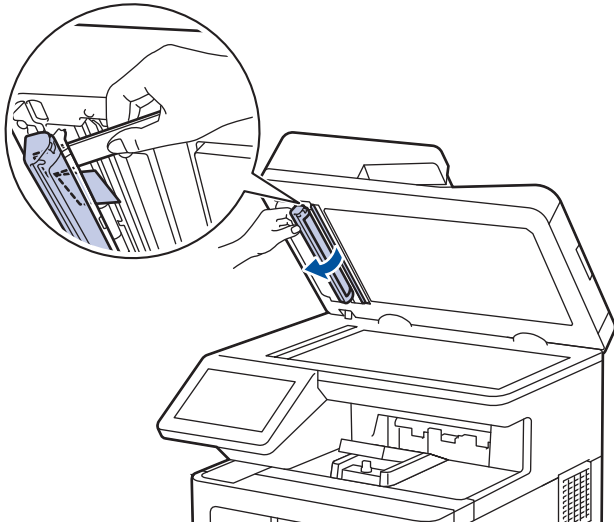

3. Close the document cover.
4. Press .

### Related Information

- [Document Jams](#)

## Paper Jams

Always remove the remaining paper from the paper tray and straighten the stack when you are adding new paper. This helps prevent multiple sheets of paper from feeding through the machine at one time and prevents paper jams.

- [Clear Paper Jams](#)
- [Paper is Jammed in the MP tray](#)
- [Paper is Jammed in the Paper Tray](#)
- [Paper is Jammed in the Back of the Machine](#)
- [Paper is Jammed Inside the Machine](#)
- [Paper is Jammed in the 2-sided Tray](#)

## Clear Paper Jams

If paper is jammed or multiple sheets of paper are fed together frequently, do the following:

- Clean the paper pick-up rollers and the separator pad of paper trays.  
*See Related Information: Clean the Paper Pick-up Rollers.*
- Load paper correctly in the tray.  
*See Related Information: Load Paper.*
- Set the correct paper size and paper type on your machine.  
*See Related Information: Paper Settings.*
- Set the correct paper size and paper type on your computer.  
*See Related Information: Print a Document (Windows).*  
*See Related Information: Print Using AirPrint.*
- Use the recommended paper.  
*See Related Information: Using Special Paper.*  
*See Related Information: Recommended Print Media.*



### Related Information

- [Paper Jams](#)

#### Related Topics:

- [Clean the Paper Pick-up Rollers](#)
- [Load Paper](#)
- [Paper Settings](#)
- [Print a Document \(Windows\)](#)
- [Print Using AirPrint](#)
- [Using Special Paper](#)
- [Recommended Print Media](#)

## Paper is Jammed in the MP tray

If the machine's control panel or the Status Monitor indicates that there is a jam in the machine's MP tray, follow these steps:

1. Remove the paper from the MP tray.
2. Slowly remove any jammed paper from in and around the MP tray.

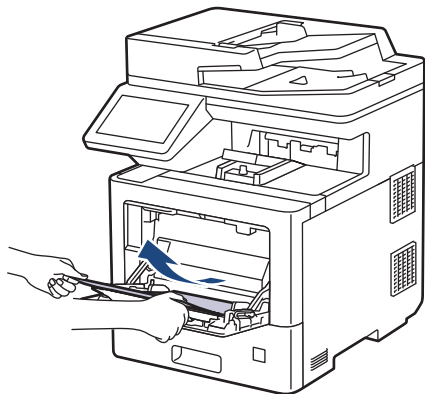

3. Fan the paper stack, and then put it back in the MP tray.
4. Reload paper in the MP tray and make sure the paper stays under the maximum paper mark (1) on both sides of the tray.

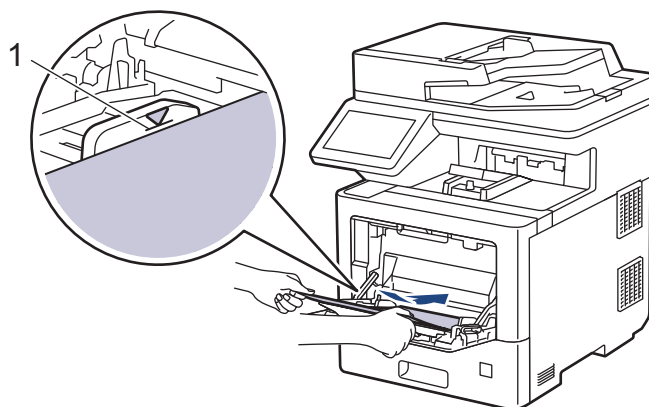

5. Follow the instructions on the machine's LCD.



### Related Information

- [Paper Jams](#)

## Paper is Jammed in the Paper Tray

If the machine's control panel or the Status Monitor indicates that there is a jam in the paper tray, follow these steps:

1. Pull the paper tray completely out of the machine.

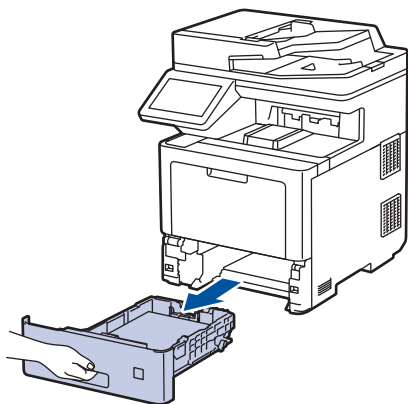

2. Slowly pull out the jammed paper.

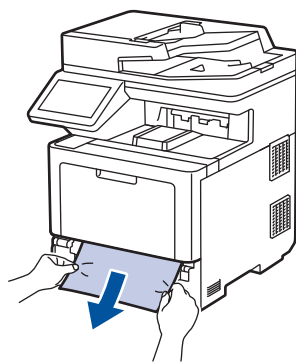

Pulling the jammed paper downwards using both hands allows you to remove the paper more easily.

3. Fan the stack of paper to prevent further jams, and slide the paper guides to fit the paper size. Load paper in the paper tray.

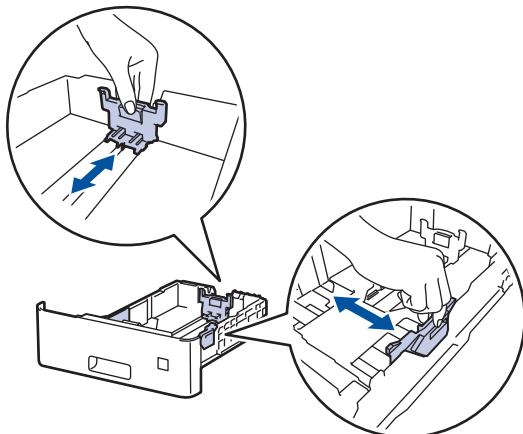

- 
4. Make sure the paper is below the maximum paper mark (▼▼▼).

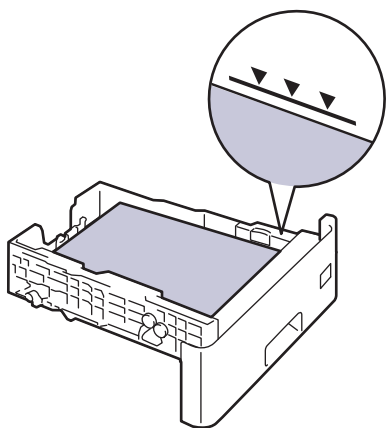

5. Put the paper tray firmly back in the machine.



### Related Information

- [Paper Jams](#)
-



## Paper is Jammed in the Back of the Machine

If the machine's control panel or the Status Monitor indicates that there is a jam in the back of the machine (Jam Rear), do the following:

 This procedure intentionally includes the opening and closing procedure of all related parts to paper jams in the back of the machine. Depending on the condition of the paper jam, the machine's LCD will indicate which parts need to be opened in order to clear the paper jam.

Follow the instructions shown on the LCD to clear the paper jam.

1. Leave the machine turned on for 10 minutes for the internal fan to cool the extremely hot parts inside the machine.
2. Open the back cover.

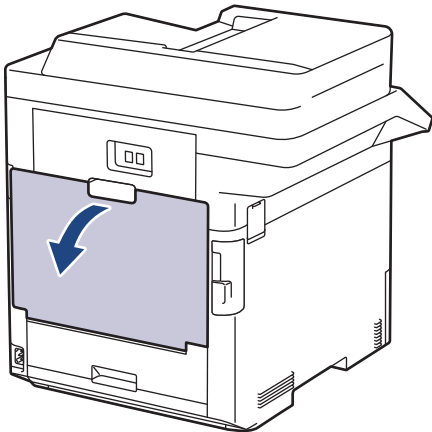

3. Pull the tabs labeled "1" at the left and right sides toward you to release the fuser cover.

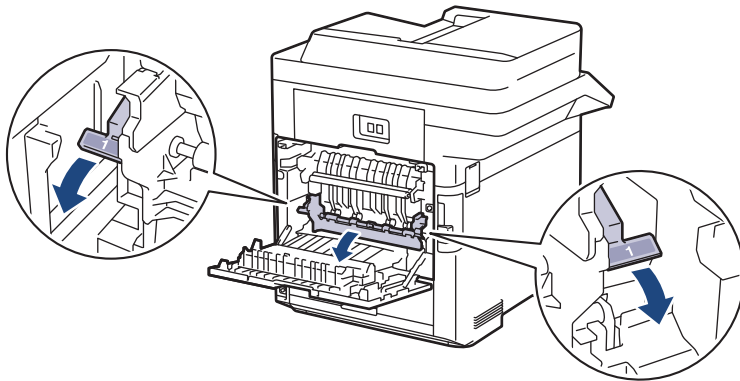

### **WARNING**

#### HOT SURFACE

The machine's internal parts will be extremely hot. Wait for the machine to cool down before touching them.

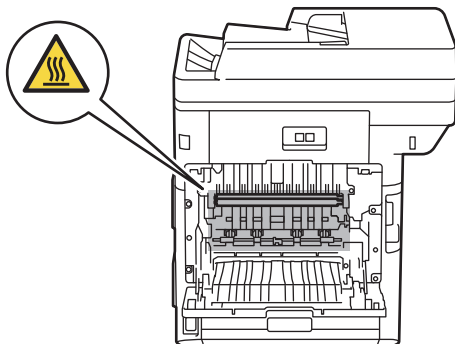

- 
4. Use both hands to gently pull the jammed paper out of the machine.

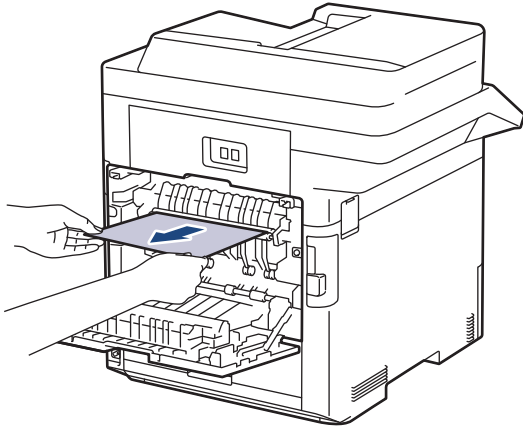

5. Pull the tabs labeled "2" at the left and right sides toward you to release the rear cover 2. (For certain models only)

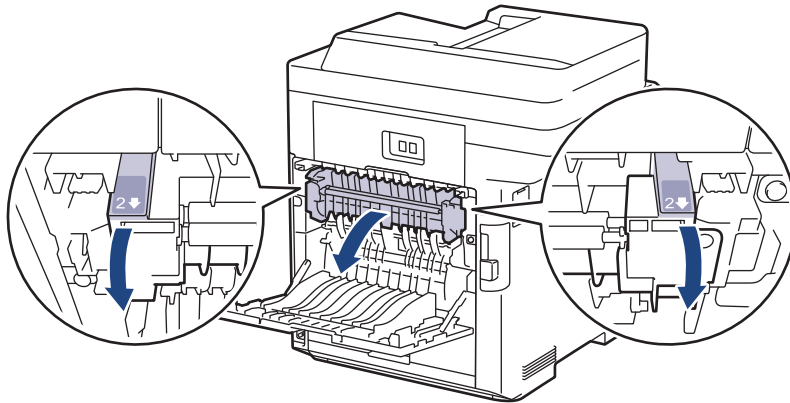

**⚠ WARNING**

**HOT SURFACE**

The machine's internal parts will be extremely hot. Wait for the machine to cool down before touching them.

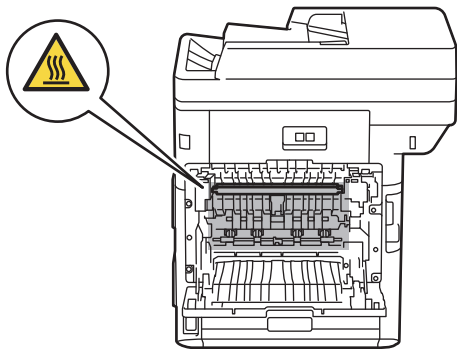

- 
6. Use both hands to gently pull the jammed paper out of the machine. (For certain models only)

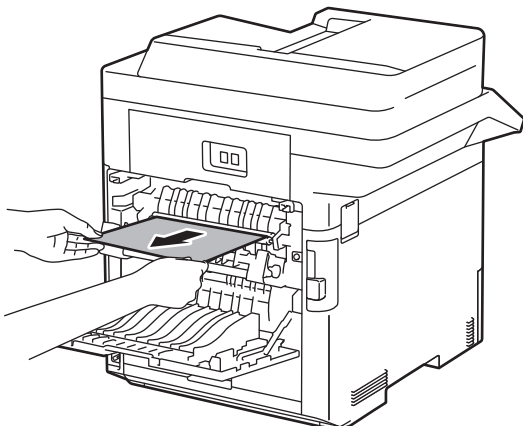

- 
7. Close the cover 2. Make sure the tabs labeled "2" at the left and right sides lock into place. (For certain models only)

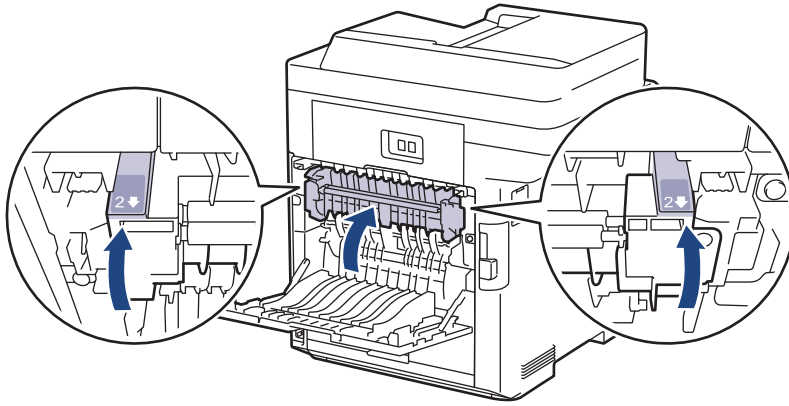

8. Close the fuser cover. Make sure the tabs labeled "1" at the left and right sides lock into place.

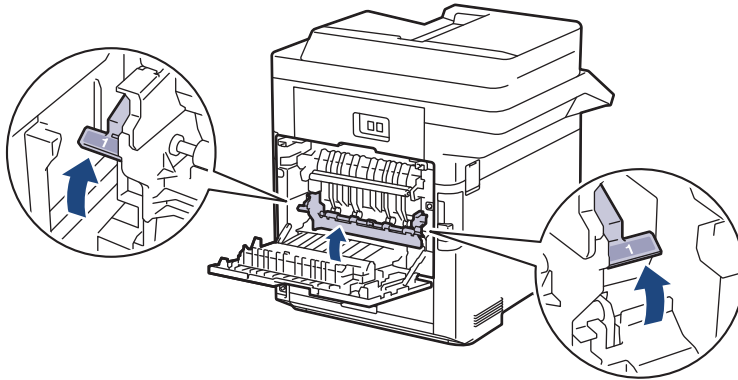

9. Close the back cover until it locks in the closed position.



## Related Information

- [Paper Jams](#)
-

## Paper is Jammed Inside the Machine

If the machine's control panel or the Status Monitor indicates that there is a jam inside the machine, follow these steps:

1. Press the front cover release button and open the front cover.

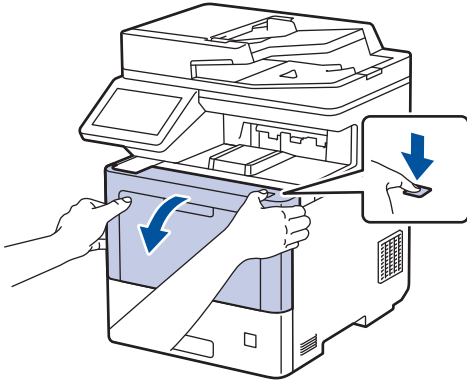

2. Hold the drum unit's green labeled handle. Pull the drum unit out of the machine until it stops.

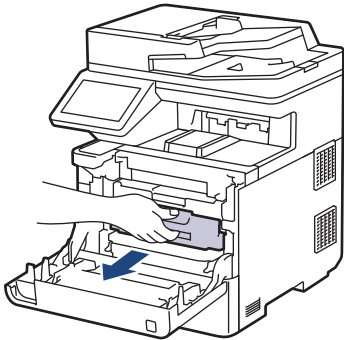

### **CAUTION**

We recommend placing the toner cartridge and drum unit assembly on a clean, flat surface with disposable paper underneath it in case you accidentally spill or scatter toner.

3. Holding the green labeled handles of the drum unit, lift the front of the drum unit and remove it from the machine.

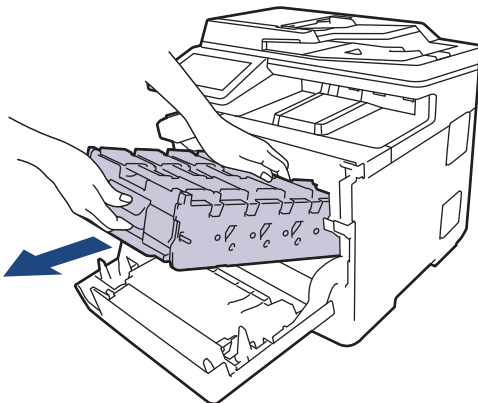

### **IMPORTANT**

Hold the handles of the drum unit when you carry it. DO NOT hold the sides of the drum unit.

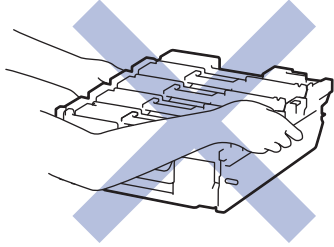

4. Slowly remove the jammed paper.

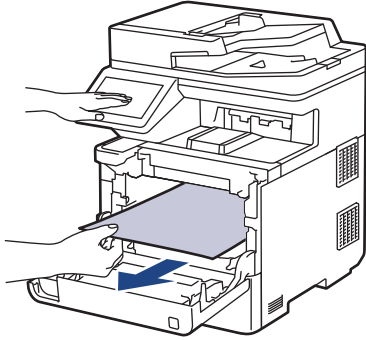

## NOTE

To avoid print quality problems, DO NOT touch the shaded parts shown in the illustrations.

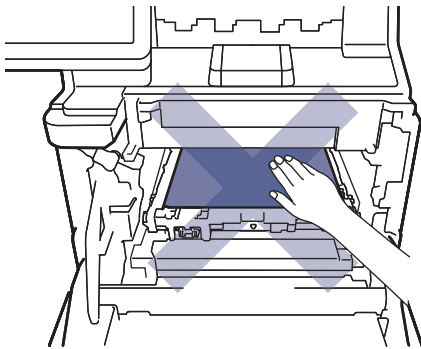

5. Gently slide the drum unit into the machine until it stops.

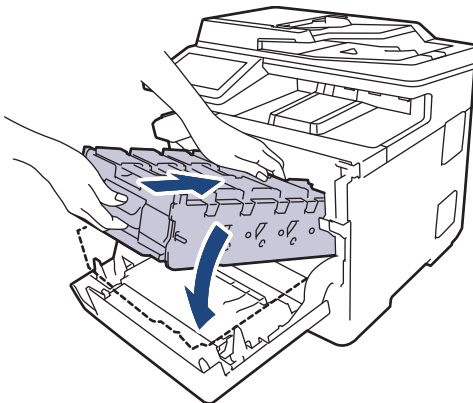

---

6. Using the green labeled handle, push the drum unit back into the machine until it locks in place.

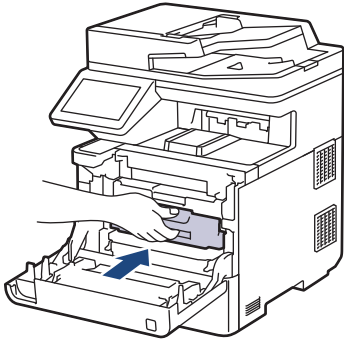

7. Close the machine's front cover.



### Related Information

- [Paper Jams](#)

## Paper is Jammed in the 2-sided Tray

If the machine's control panel or the Status Monitor indicates that there is a jam in the 2-sided paper tray, follow these steps:

1. Leave the machine turned on for 10 minutes for the internal fan to cool the extremely hot parts inside the machine.
2. Pull the paper tray completely out of the machine.

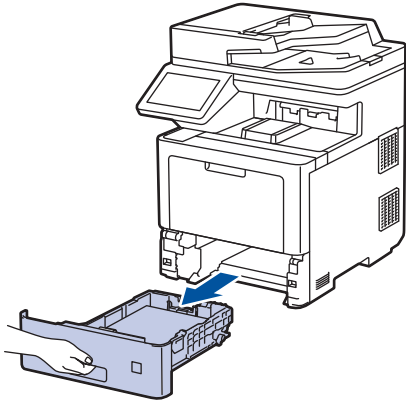

3. At the back of the machine, pull the 2-sided tray completely out of the machine.

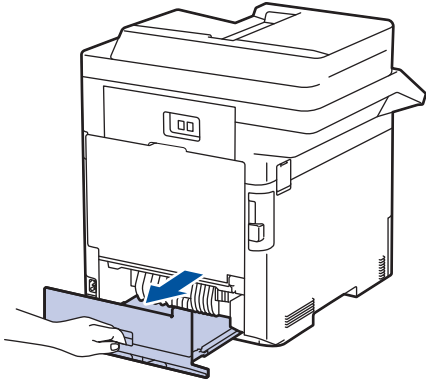

4. Slowly remove the jammed paper out of the machine, out of the 2-sided tray, or out of the paper tray.

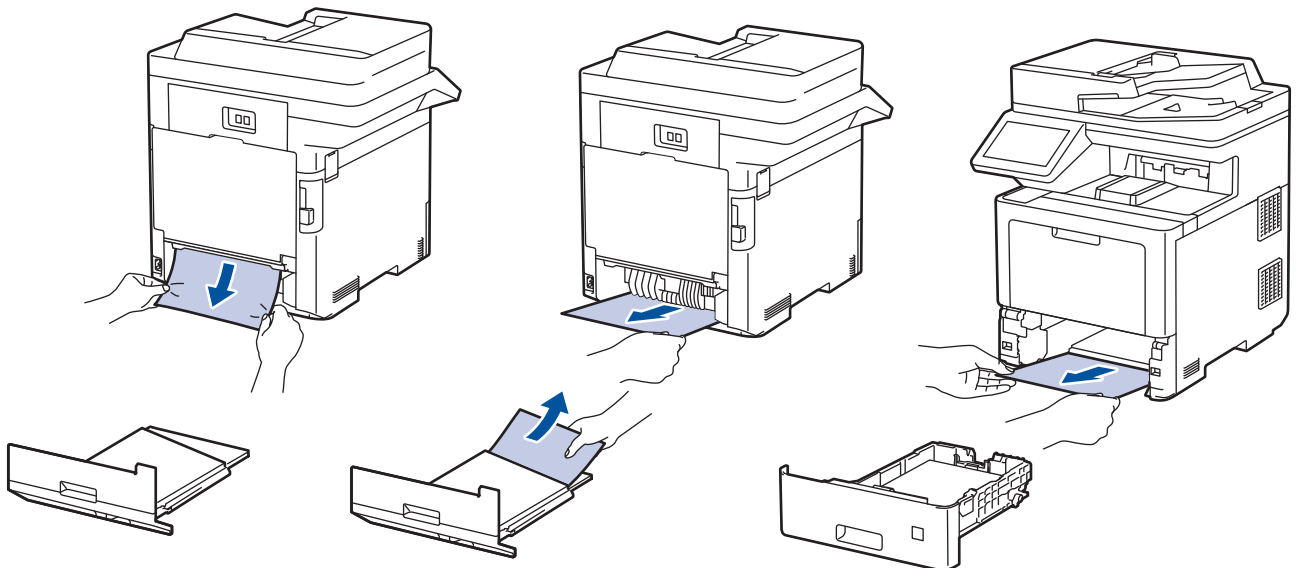







5. Put the 2-sided tray firmly back in the rear of the machine.
6. Put the paper tray firmly back in the front of the machine.

### ✓ Related Information

- [Paper Jams](#)

## Printing Problems

If, after reading this table, you still need help, see the latest troubleshooting tips at [support.brother.com](http://support.brother.com).

| Difficulties | Suggestions   |
|--------------|---|
| No printout  | <p>Check the machine is not in Power Off mode.</p> <p>If the machine is in Power Off mode, press , and then send the print data again.</p>   |
|              | <p>Check that the correct printer driver has been installed and selected.</p> <p>Check to see if the Status Monitor or the machine's control panel displays an error status.</p> <p>Check that the machine is online:</p> <ul style="list-style-type: none"> <li>• Windows 10, Windows Server 2016 and Windows Server 2019           <p>Click  &gt; <b>Windows System &gt; Control Panel</b>. In the <b>Hardware and Sound</b> group, click <b>View devices and printers</b>. Right-click the <b>Brother XXX-XXXX</b>. Click <b>See what's printing</b>. If printer driver options appear, select your printer driver. Click <b>Printer</b> in the menu bar and make sure that <b>Use Printer Offline</b> is not selected.</p> </li> <li>• Windows Server 2012 R2           <p>Click <b>Control Panel</b> on the <b>Start</b> screen. In the <b>Hardware</b> group, click <b>View devices and printers</b>. Right-click the <b>Brother XXX-XXXX</b>. Click <b>See what's printing</b>. If printer driver options appear, select your printer driver. Click <b>Printer</b> in the menu bar and make sure <b>Use Printer Offline</b> is not selected.</p> </li> <li>• Windows 8.1 and Windows Server 2012           <p>Move your mouse to the lower right corner of your desktop. When the menu bar appears, click <b>Settings &gt; Control Panel</b>. In the <b>Hardware and Sound</b> group, click <b>View devices and printers</b>. Right-click the <b>Brother XXX-XXXX</b>. Click <b>See what's printing</b>. If printer driver options appear, select your printer driver. Click <b>Printer</b> in the menu bar and make sure that <b>Use Printer Offline</b> is not selected.</p> </li> <li>• Windows7 and Windows Server 2008 R2           <p>Click  (<b>Start</b>) &gt; <b>Devices and Printers</b> . Right-click <b>Brother XXX-XXXX</b> and click <b>See what's printing</b>. Click <b>Printer</b> in the menu bar. Make sure <b>Use Printer Offline</b> is not selected.</p> </li> <li>• Windows Server 2008           <p>Click  (<b>Start</b>) &gt; <b>Control Panel &gt; Hardware and Sound &gt; Printers</b>. Right-click <b>Brother XXX-XXXX</b>. Make sure <b>Use Printer Online</b> is not listed. If it is listed, click this option to set the driver Online.</p> </li> </ul> |
|              | <p>Mac</p> <p>Click the <b>System Preferences</b> menu, and then select the <b>Printers &amp; Scanners</b> option. When the machine is offline, delete it using the  button, and then add it using the  button.</p>   |



| Difficulties   | Suggestions   |
|--|---|
| The machine is not printing or has stopped printing.   | Cancel the print job and clear it from the machine's memory. The printout may be incomplete. Send the print data again.<br><i>See Related Information:Cancel a Print Job.</i>                                     |
| The headers or footers appear when the document displays on the screen but they do not show up when it is printed.   | There is an unprintable area on the top and bottom of the page. Adjust the top and bottom margins in your document to allow for this.   |
| The machine prints unexpectedly or it prints garbage.  | Cancel the print job and clear it from the machine's memory. The printout may be incomplete. Send the print data again.<br><i>See Related Information:Cancel a Print Job.</i>                                     |
|  | Check the settings in your application to make sure they are set up to work with your machine.  |
|  | Confirm that the Brother printer driver is selected in your application's Print window.   |
| The machine prints the first couple of pages correctly, then some pages have missing text.   | Check the settings in your application to make sure they are set up to work with your machine.  |
|  | Your machine is not receiving all of the data sent from the computer. Make sure you connected the interface cable correctly.  |
| The machine does not print on both sides of the paper even though the printer driver setting is 2-sided and the machine supports automatic 2-sided printing. | Check the paper size setting in the printer driver. You must select A4, Letter, Legal, Folio, Mexico Legal, India Legal paper, or A4 Short (270mm Paper). Supported paper weight is 60 to 230 g/m <sup>2</sup>    |
| Print speed is too slow.   | Try changing the printer driver setting. The highest resolution needs longer data processing, sending, and printing time.   |
|  | If you have enabled Quiet Mode, disable it in the printer driver or the machine's menu setting.   |
| The machine does not feed paper.   | If there is paper in the paper tray, make sure it is straight. If the paper is curled, straighten it. Sometimes it is helpful to remove the paper, turn the stack over and place it back in the paper tray.       |
|  | Fan the stack of paper well and place it back to the paper tray.  |
|  | Reduce the amount of paper in the paper tray, and then try again.   |
|  | (For models with MP Tray)Make sure <b>MP Tray</b> is not selected for <b>Paper Source</b> in the printer driver.  |
|  | Clean the paper pick-up rollers.  |
| The machine does not feed paper from the MP tray. (For models with MP Tray)  | Fan the paper well and place it back in the MP tray firmly.   |
|  | Make sure <b>MP Tray</b> is selected as <b>Paper Source</b> in the printer driver.  |
| The machine does not feed envelopes.   | (For models with MP Tray)Load envelopes in the MP tray. Your application must be set to print the envelope size you are using. This is usually done in the Page Setup or Document Setup menu of your application. |
| Print position is misaligned with the letterhead or preprinted objects.  | Adjust the print position using the Print Position setting for each paper tray.   |



## Related Information

- [Troubleshooting](#)

---

**Related Topics:**

- [Monitor the Status of the Machine from Your Computer \(Windows\)](#)
  - [Cancel a Print Job](#)
  - [Load and Print Using the Paper Tray](#)
  - [Clean the Paper Pick-up Rollers](#)
  - [Load and Print Using the Multi-purpose Tray \(MP Tray\)](#)
-



## Improve the Print Quality

If you have a print quality problem, print a test page first. If the printout looks good, the problem is probably not the machine. Check the interface cable connections and try printing a different document. If the printout or test page printed from the machine has a quality problem, check the examples of poor print quality and follow the recommendations in the table.

### IMPORTANT

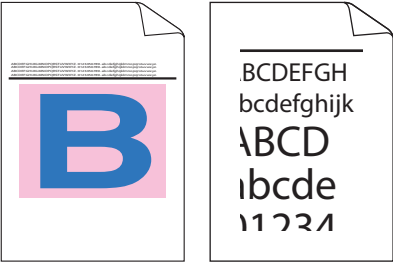
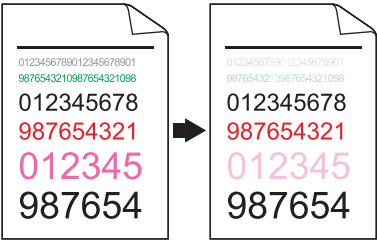

Using non-genuine supplies may affect the print quality, hardware performance, and machine reliability.

1. To get the best print quality, we suggest using recommended print media. Make sure you use paper that meets our specifications.
2. Check that the drum unit and toner cartridges are installed correctly.

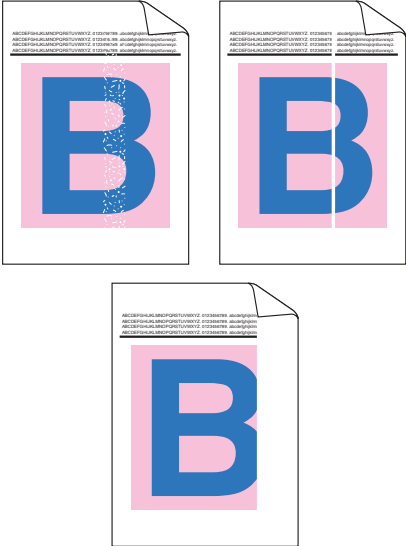
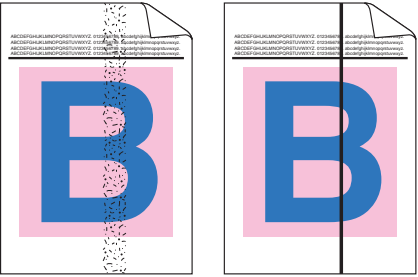
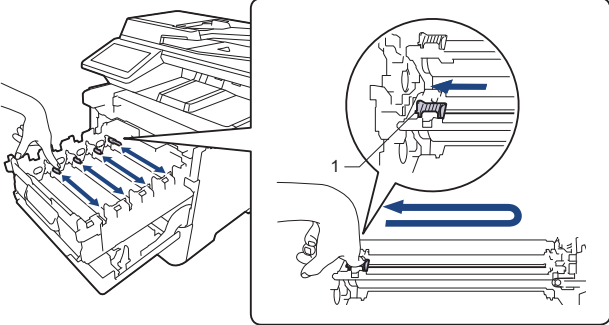
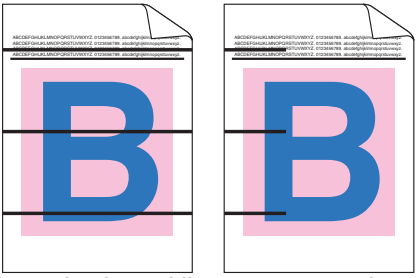
| Examples of poor print quality  | Recommendation   |
|---|--|
|  <p>Printed pages are compressed, horizontal stripes appear, or characters in the top, bottom, left, or right margins are cut off</p> | <p>Adjust the print margins in your document's application and reprint the job.</p>  |
|  <p>Coloured letters and thin letters in the original document are light or faint in the copy</p>                                    | <ul style="list-style-type: none"> <li>• Choose <b>Text</b> or <b>Receipt</b> in the copy quality setting.</li> <li>• Adjust the copy density and contrast.</li> </ul>   |
|  <p>Colours are light or faint on the whole page</p>   | <ul style="list-style-type: none"> <li>• Use the machine's LCD to perform calibration.<br/><i>See Related Information: Correct Colour Printing.</i></li> <li>• Adjust the copy density and contrast if you are copying.</li> <li>• Make sure Toner Save mode is off on the LCD or in the printer driver.<br/><i>See Related Information: Reduce Toner Consumption.</i></li> <li>• Make sure the media type setting in the printer driver matches the type of paper you are using.</li> <li>• Shake all four toner cartridges gently.</li> <li>• Wipe the laser scanner windows with a dry, soft lint-free cloth.<br/><i>See Related Information: Clean the Laser Scanner Windows.</i></li> </ul> |

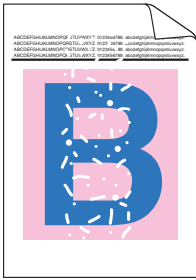
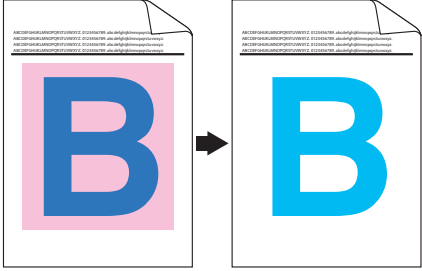
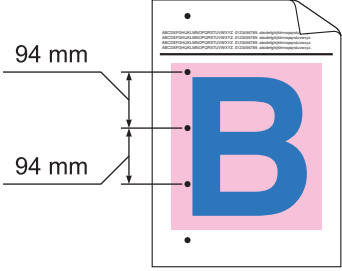
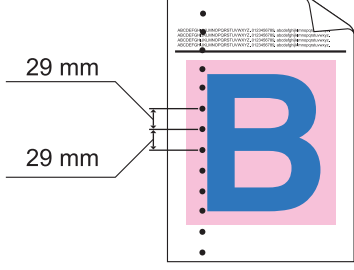
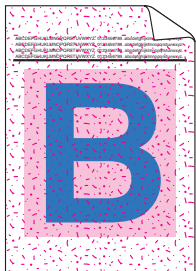
| Examples of poor print quality  | Recommendation   |
|---|--|
|  <p data-bbox="188 712 762 741">Vertical white streaks or bands appear on the page</p>       | <ul data-bbox="820 168 1452 465" style="list-style-type: none"> <li>• Wipe the laser scanner windows with a dry, soft lint-free cloth.<br/><i>See Related Information: Clean the Laser Scanner Windows.</i></li> <li>• Wipe the scanner glass strip with a dry lint free soft cloth.</li> <li>• Make sure foreign material, such as a torn piece of paper, sticky notes, or dust is not inside the machine and around the drum unit and toner cartridges.</li> </ul>   |
|  <p data-bbox="169 1070 782 1099">Vertical coloured streaks or bands appear on the page</p> | <ul data-bbox="820 757 1444 952" style="list-style-type: none"> <li>• Wipe the scanner glass strip with a dry lint free soft cloth.</li> <li>• Clean all four corona wires (one for each colour) inside the drum unit by sliding the green tab. Make sure the green tab of the corona wire is in the home position (1).</li> </ul>  <ul data-bbox="820 1301 1469 1579" style="list-style-type: none"> <li>• Replace the toner cartridge that matches the colour of the streak or band.<br/>To identify the colour of the toner cartridge, visit <a href="http://support.brother.com">support.brother.com</a> and view the <b>FAQs &amp; Troubleshooting</b> page for your model.<br/><i>See Related Information: Replace the Toner Cartridge.</i></li> <li>• Install a new drum unit.<br/><i>See Related Information: Replace the Drum Unit.</i></li> </ul> |
|  <p data-bbox="220 1861 734 1890">Horizontal coloured lines appear on the page</p>         | <ul data-bbox="820 1592 1465 1870" style="list-style-type: none"> <li>• Identify the colour causing the problem and replace the toner cartridge that matches the colour of the line.<br/>To identify the colour of the toner cartridge, visit <a href="http://support.brother.com">support.brother.com</a> to see the <b>FAQs &amp; Troubleshooting</b> page.<br/><i>See Related Information: Replace the Toner Cartridge.</i></li> <li>• Install a new drum unit.<br/><i>See Related Information: Replace the Drum Unit.</i></li> </ul>   |

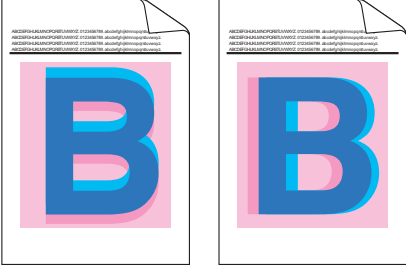
| Examples of poor print quality  | Recommendation   |
|---|--|
|  <p data-bbox="405 443 544 472">White spots</p>                        | <ul data-bbox="820 165 1474 573" style="list-style-type: none"> <li>• Make sure the media type setting in the printer driver matches the type of paper you are using.</li> <li>• Check the machine's environment. Conditions such as high humidity and high temperatures may cause this print quality problem.</li> <li>• If the problem is not solved after printing a few pages, the drum may have foreign material, such as glue from a label, stuck on the drum surface. Clean the drum unit.<br/><i>See Related Information: Clean the Drum Unit.</i></li> <li>• Install a new drum unit.<br/><i>See Related Information: Replace the Drum Unit.</i></li> </ul> |
|  <p data-bbox="268 864 684 893">Blank page or some missing colours</p> | <ul data-bbox="820 595 1474 875" style="list-style-type: none"> <li>• Identify the colour causing the problem and install a new toner cartridge.<br/>To identify the colour of the toner cartridge, visit <a href="http://support.brother.com">support.brother.com</a> to see the <b>FAQs &amp; Troubleshooting</b> page.<br/><i>See Related Information: Replace the Toner Cartridge.</i></li> <li>• Install a new drum unit.<br/><i>See Related Information: Replace the Drum Unit.</i></li> </ul>   |
|  <p data-bbox="331 1178 620 1207">Coloured spots at 94 mm</p>         | <ul data-bbox="820 909 1474 1155" style="list-style-type: none"> <li>• If the problem is not solved after printing a few pages, the drum may have foreign material, such as glue from a label, stuck on the drum surface. Clean the drum unit.<br/><i>See Related Information: Clean the Drum Unit.</i></li> <li>• Install a new drum unit.<br/><i>See Related Information: Replace the Drum Unit.</i></li> </ul>  |
|  <p data-bbox="331 1503 620 1532">Coloured spots at 29 mm</p>        | <ul data-bbox="820 1234 1474 1435" style="list-style-type: none"> <li>• Identify the colour causing the problem and install a new toner cartridge.<br/>To identify the colour of the toner cartridge, visit <a href="http://support.brother.com">support.brother.com</a> to see the <b>FAQs &amp; Troubleshooting</b> page.<br/><i>See Related Information: Replace the Toner Cartridge.</i></li> </ul>  |
|  <p data-bbox="323 1816 625 1845">Toner scatter or toner stain</p>   | <ul data-bbox="820 1547 1474 1917" style="list-style-type: none"> <li>• Check the machine's environment. Conditions such as high humidity and high temperatures may cause this print quality problem.</li> <li>• Identify the colour causing the problem and put in a new toner cartridge.<br/>To identify the colour of the toner cartridge, visit <a href="http://support.brother.com">support.brother.com</a> to see the <b>FAQs &amp; Troubleshooting</b> page.<br/><i>See Related Information: Replace the Toner Cartridge.</i></li> <li>• Install a new drum unit. <i>See Related Information: Replace the Drum Unit.</i></li> </ul>                           |
| <p data-bbox="177 1928 775 1957">The colour of your printouts is not what you expected</p>  | <ul data-bbox="820 1928 1474 2063" style="list-style-type: none"> <li>• To improve the colour density, perform the colour correction using the LCD.</li> <li>• To adjust the print position of colours for sharper edges, perform the colour correction using the LCD.</li> </ul>  |

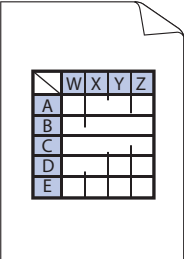
| Examples of poor print quality   | Recommendation  |
|--|---|
|  | <ul style="list-style-type: none"> <li>Adjust the copy density and contrast if you are copying.</li> <li>Make sure Toner Save mode is off on the LCD or in the printer driver.</li> <li>If the print quality of the black portion is not what you expected, select the <b>Enhance Black Printing</b> checkbox in the printer driver.</li> <li>Clear the <b>Improve Grey Colour</b> checkbox in the printer driver.</li> <li>Identify the colour causing the problem and put in a new toner cartridge.<br/>To identify the colour of the toner cartridge, visit <a href="http://support.brother.com">support.brother.com</a> to see the <b>FAQs &amp; Troubleshooting</b> page.<br/><i>See Related Information: Replace the Toner Cartridge.</i></li> <li>Install a new drum unit.<br/><i>See Related Information: Replace the Drum Unit.</i></li> </ul> |
|  <p data-bbox="403 1039 549 1066">Colour offset</p>                          | <ul style="list-style-type: none"> <li>Make sure the machine is on a solid level surface.</li> <li>Perform the colour correction using the LCD.</li> <li>Install a new drum unit.<br/><i>See Related Information: Replace the Drum Unit.</i></li> <li>Install a new belt unit.<br/><i>See Related Information: Replace the Belt Unit.</i></li> </ul>  |
|  <p data-bbox="256 1352 699 1379">Uneven colour density across the page</p> | <ul style="list-style-type: none"> <li>Perform the colour correction using the LCD.</li> <li>Adjust the copy density and contrast if you are copying.</li> <li>Clear the <b>Improve Grey Colour</b> checkbox in the printer driver.</li> <li>Identify the colour causing the problem and put in a new toner cartridge.<br/>To identify the colour of the toner cartridge, visit <a href="http://support.brother.com">support.brother.com</a> to see the <b>FAQs &amp; Troubleshooting</b> page.<br/><i>See Related Information: Replace the Toner Cartridge.</i></li> <li>Install a new drum unit.<br/><i>See Related Information: Replace the Drum Unit.</i></li> </ul>  |
|  <p data-bbox="320 1816 632 1843">Missing thin lines in images</p>          | <ul style="list-style-type: none"> <li>Make sure Toner Save mode is off on the LCD or in the printer driver.</li> <li>Change the print resolution.</li> <li>If you use a Windows printer driver, select <b>Improve Pattern Printing</b> in Print Setting of the <b>Basic</b> tab.</li> </ul>  |

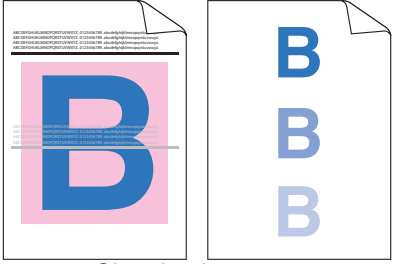
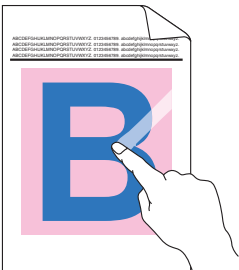
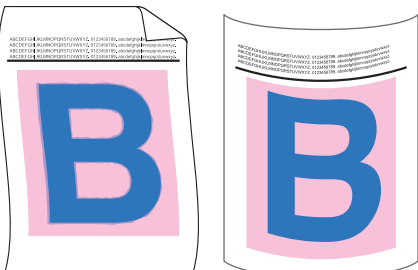
| Examples of poor print quality  | Recommendation  |
|---|---|
|  <p data-bbox="379 436 571 465">Wrinkled printout</p>        | <ul data-bbox="817 168 1455 309" style="list-style-type: none"> <li>• Check the paper type and quality.</li> <li>• Make sure the back cover is closed correctly.</li> <li>• Make sure the media type setting in the printer driver matches the type of paper you are using.</li> </ul>  |
|  <p data-bbox="379 757 571 786">Ghosting images</p>          | <ul data-bbox="817 481 1476 683" style="list-style-type: none"> <li>• Check the machine's environment. Conditions such as low humidity and low temperatures may cause this print quality problem.</li> <li>• Make sure the media type setting in the printer driver matches the type of paper you are using.</li> <li>• Install a new drum unit.</li> </ul> <p data-bbox="858 689 1407 719"><i>See Related Information: Replace the Drum Unit.</i></p>  |
|  <p data-bbox="363 1077 603 1106">Toner smears easily</p>   | <ul data-bbox="817 795 1455 929" style="list-style-type: none"> <li>• Make sure the media type setting in the printer driver matches the type of paper you are using.</li> <li>• Select <b>Improve Toner Fixing</b> mode in the printer driver.</li> </ul> <p data-bbox="858 936 1465 1064">If this selection does not provide enough improvement, change the printer driver setting in <b>Media Type</b> to a thick setting. If you are printing an envelope, select <b>Env. Thick</b> in the media type setting.</p>  |
|  <p data-bbox="352 1391 603 1420">Curled or wavy image</p> | <ul data-bbox="817 1124 1476 1563" style="list-style-type: none"> <li>• Select <b>Reduce Paper Curl</b> mode in the printer driver. If the problem is not solved, select <b>Plain Paper</b> in the media type setting.</li> <li>• If you are printing an envelope, select <b>Env. Thin</b> in the Media Type Setting of the printer driver.</li> <li>• If you do not use the machine often, the paper may have been in the paper tray too long. Turn over the stack of paper in the paper tray. Also, fan the paper stack and then rotate the paper 180° in the paper tray.</li> <li>• Store the paper where it will not be exposed to high temperatures and high humidity.</li> <li>• Open the back cover (Face up output tray) to let the printed paper exit onto the Face up output tray.</li> </ul> |



## Related Information

- [Troubleshooting](#)

### Related Topics:

- [Correct Colour Printing](#)
- [Test Print](#)
- [Clean the Drum Unit](#)
- [Reduce Toner Consumption](#)
- [Replace the Toner Cartridge](#)
- [Replace the Drum Unit](#)
- [Replace the Belt Unit](#)
- [Clean the Laser Scanner Windows](#)

## Telephone and Fax Problems

### Telephone Line or Connections

| Difficulties                              | Suggestions   |
|---|---|
| Dialling does not work.<br>(No dial tone) | Check all line cord connections. Make sure the telephone line cord is plugged into the telephone wall socket and the LINE socket of the machine. If you subscribe to DSL or VoIP services, contact your service provider for connection instructions.   |
|   | (Available only for some countries.)<br>Change the Tone/Pulse setting.  |
|   | If an external phone is connected to the machine, send a manual fax by lifting the handset of the external telephone and dialling the number using the external telephone. Wait to hear the fax receiving tones before sending fax.   |
|   | If there is no dial tone, connect a known working telephone and telephone line cord to the socket. Then lift the external telephone's handset and listen for a dial tone. If there is still no dial tone, ask your telephone company to check the line and/or wall socket.  |
| The machine does not answer when called.  | Make sure the machine is in the correct receive mode for your setup.<br>Check for a dial tone. If possible, call your machine to hear it answer. If there is still no answer, check that the telephone line cord is plugged into the telephone wall socket and the LINE socket of the machine. If there is no ringing when you call your machine, ask your telephone company to check the line. |

### Handling Incoming Calls

| Difficulties                       | Suggestions  |
|------------------------------------|--|
| Sending a Fax Call to the machine. | If you answered on an extension or external telephone, press your Remote Activation Code (the factory setting is *51). If you answered on the external telephone, press the Start button to receive the fax.<br>When your machine answers, hang up.  |
| Custom features on a single line.  | If you have Call Waiting, Voice Mail, an answering machine, an alarm system or other custom feature on a single telephone line with your machine, it may create a problem sending or receiving faxes.<br><b>For Example:</b> If you subscribe to Call Waiting or some other custom service and its signal comes through the line while your machine is sending or receiving a fax, the signal can temporarily interrupt or disrupt the faxes. Brother's ECM (Error Correction Mode) feature should help overcome this problem. This condition is related to the telephone system industry and is common to all devices that send and receive information on a single, shared line with custom features. If avoiding a slight interruption is crucial to your business, we recommend using a separate telephone line with no custom features. |

### Receiving Faxes

| Difficulties          | Suggestions  |
|-----------------------|--|
| Cannot receive a fax. | Check all line cord connections. Make sure the telephone line cord is plugged into the telephone wall socket and the LINE socket of the machine. If you subscribe to DSL or VoIP services, contact your service provider for connection instructions. If you are using a VoIP system, try changing the VoIP setting to <i>Basic (for VoIP)</i> . This will lower modem speed and turn off Error Correction Mode (ECM). |



| Difficulties          | Suggestions   |
|-----------------------|---|
| Cannot receive a fax. | <p>Make sure the machine is in the correct Receive Mode. This is determined by the external devices and telephone subscriber services you have on the same line as the Brother machine.</p> <ul style="list-style-type: none"> <li>If you have a dedicated fax line and want your Brother machine to automatically answer all incoming faxes, you should select Fax only mode.</li> <li>If your Brother machine shares a line with an external answering machine, you should select the External TAD mode. In External TAD mode, your Brother machine will receive incoming faxes automatically and voice callers will be able to leave a message on your answering machine.</li> <li>If your Brother machine shares a line with other telephones and you want it to automatically answer all incoming faxes, you should select the Fax/Tel mode. In Fax/Tel mode, your Brother machine will receive faxes automatically and produce a pseudo/double-ring to alert you to answer voice calls.</li> <li>If you do not want your Brother machine to answer any incoming faxes automatically, you should select the Manual mode. In Manual mode, you must answer every incoming call and activate the machine to receive faxes.</li> </ul> |
|                       | <p>Another device or service at your location may be answering the call before your Brother machine answers. To test this, lower the Ring Delay setting:</p> <ul style="list-style-type: none"> <li>If the Receive Mode is set to Fax Only or Fax/Tel, reduce the Ring Delay to the minimum value (excluding "0").<br/><i>See Related Information: Set the Number of Rings Before the Machine Answers (Ring Delay).</i></li> <li>If the Receive Mode is set to External TAD, reduce the number of rings programmed on your answering machine to two.</li> <li>If the Receive Mode is set to Manual, DO NOT adjust the Ring Delay setting.</li> </ul>  |
|                       | <p>Have someone send you a test fax:</p> <ul style="list-style-type: none"> <li>If you received the test fax successfully, your machine is operating correctly. Remember to reset your Ring Delay or answering machine setting back to your original setting. If receiving problems recur after resetting the Ring Delay, then a person, device, or subscriber service is answering the fax call before the machine has a chance to answer.</li> <li>If you were not able to receive the fax, then another device or subscriber service may be interfering with your fax reception or there may be a problem with your fax line.</li> </ul>   |
|                       | <p>If you are using a telephone answering machine (External TAD mode) on the same line as the Brother machine, make sure your answering machine is set up correctly.</p> <ol style="list-style-type: none"> <li>Set your answering machine to answer in one or two rings.</li> <li>Record the outgoing message on your answering machine. <ul style="list-style-type: none"> <li>Record five seconds of silence at the beginning of your outgoing message.</li> <li>Limit your speaking to 20 seconds.</li> <li>End your outgoing message with your Remote Activation Code for people sending manual faxes. For example: "After the beep, leave a message or press *51 and Start to send a fax."</li> </ul> </li> <li>Set your answering machine to answer calls.</li> <li>Set your Brother machine's Receive Mode to External TAD.<br/><i>See Related Information: Choose the Correct Receive Mode.</i></li> </ol>   |
|                       | <p>Make sure your Brother machine's Fax Detect feature is turned On. Fax Detect is a feature that allows you to receive a fax even if you answered the call on an external or extension telephone.</p>  |
|                       | <p>If you often get transmission errors due to possible interference on the telephone line or if you are using a VoIP system, try changing the Compatibility setting to <i>Basic (for VoIP)</i>.</p>  |
|                       | <p>Contact your administrator to check your Secure Function Lock Settings.</p>  |
|                       |   |

## Sending Faxes

| Difficulties       | Suggestions  |
|--------------------|--|
| Cannot send a fax. | <p>Check all line cord connections. Make sure the telephone line cord is plugged into the telephone wall socket and the LINE socket of the machine. If you subscribe to DSL or VoIP services, contact your service provider for connection instructions.</p> |
|                    | <p>Make sure you pressed Fax and the machine is in Fax mode.</p>   |
|                    | <p>Print the Transmission Verification Report and check for an error.</p>  |

| Difficulties  | Suggestions   |
|---|---|
| Cannot send a fax.                                  | Contact your administrator to check your Secure Function Lock Settings.<br>Ask the other party to check that the receiving machine has paper.   |
| Poor sending quality.                               | Try changing your resolution to Fine or S.Fine. Make a copy to check your machine's scanner operation. If the copy quality is poor, clean the scanner.  |
| Transmission Verification Report says RESULT:ERROR. | There is probably temporary noise or static on the line. Try sending the fax again. If you are sending a PC-Fax message and get RESULT:ERROR on the Transmission Verification Report, your machine may be out of memory. To free up extra memory, you can turn off Fax Storage, print fax messages in memory or cancel a delayed fax. If the problem continues, ask the telephone company to check your telephone line.<br>If you often get transmission errors due to possible interference on the telephone line or if you are using a VoIP system, try changing the Compatibility setting to Basic (for VoIP). |
| Sent faxes are blank.                               | Make sure you are loading the document correctly. When using the ADF, the document should be face up. When using the scanner glass, the document should be face down.   |
| Vertical black lines when sending.                  | Black vertical lines on faxes you send are typically caused by dirt or correction fluid on the glass strip. Clean the glass strip.  |

### Printing received faxes

| Difficulties   | Suggestions   |
|--|---|
| <ul style="list-style-type: none"> <li>Condensed print</li> <li>Horizontal streaks</li> <li>Top and bottom sentences are cut off</li> <li>Missing lines</li> </ul>  | This is usually caused by a poor telephone connection. Make a copy; if your copy looks good, you probably had a bad connection, with static or interference on the telephone line. Ask the other party to send the fax again.                       |
| Vertical black lines when receiving  | The corona wires for printing may be dirty. Clean the corona wires in the drum unit.<br>The sender's scanner may be dirty. Ask the sender to make a copy to see if the problem is with the sending machine. Try receiving from another fax machine. |
| Received faxes appear as split or blank pages.   | Left and right margins are cut off or a single page is printed on two pages.<br>Turn on Auto Reduction.   |



### Related Information

- [Troubleshooting](#)
  - [Set Dial Tone Detection](#)
  - [Set Telephone Line Compatibility for Interference and VoIP Systems](#)

### Related Topics:

- [Set the Number of Rings Before the Machine Answers \(Ring Delay\)](#)
- [Choose the Correct Receive Mode](#)

## Set Dial Tone Detection

Setting the Dial Tone to [Detection] shortens the Dial Tone detect pause.

1. Press  [Settings] > [All Settings] > [Initial Setup] > [Dial Tone].



If your machine displays the [All Settings] menu on the Home screen, skip the [Settings] menu.

2. Press [Detection] or [No Detection].
3. Press .



### Related Information

- [Telephone and Fax Problems](#)

## Set Telephone Line Compatibility for Interference and VoIP Systems

Problems sending and receiving faxes due to possible interference on the telephone line may be solved by reducing the modem speed to minimise errors in fax transmission. If you are using a Voice over IP (VoIP) service, we recommend changing the compatibility to Basic (for VoIP).



- VoIP is a type of phone system that uses an Internet connection, rather than a traditional phone line.
- Telephone providers frequently bundle VoIP together with Internet and cable services.

1. Press  [Settings] > [All Settings] > [Initial Setup] > [Compatibility].



If your machine displays the [All Settings] menu on the Home screen, skip the [Settings] menu.

2. Press the option you want.

- Select [High] to set the modem speed to 33600 bps.
- Select [Normal] to set the modem speed to 14400 bps.
- Select [Basic (for VoIP)] to reduce the modem speed to 9600 bps and turn off Error Correction Mode (ECM). Unless interference is a recurring problem on your telephone line, you may prefer to use this option only when needed.

3. Press .



### Related Information

- [Telephone and Fax Problems](#)

## Network Problems

- [Error Messages](#)
- [Use the Network Connection Repair Tool \(Windows\)](#)
- [Check Your Machine's Network Settings](#)
- [If You Are Having Difficulty with Your Machine's Network](#)

## Error Messages

The most common error messages are shown in the table.

| Error Messages  | Cause   | Action  |
|---|---|---|
| The maximum number of devices are already connected using Wi-Fi Direct. | Four mobile devices are already connected to the Wi-Fi Direct network when the Brother machine is the Group Owner.                              | After the current connection between your Brother machine and another mobile device has shut down, try to configure the Wi-Fi Direct settings again. You can confirm the connection status by printing the Network Configuration Report.  |
| Authentication Error, contact your administrator.                       | Your authentication setting for the Store Print Log to Network feature is not correct.  | <ul style="list-style-type: none"> <li>Make sure the <b>Username</b> and <b>Password</b> in <b>Authentication Setting</b> are correct. If the username is part of a domain, enter the username in one of the following styles: user@domain or domain\user.</li> <li>Make sure the time of the log file server matches the time from the SNTP server, or the <b>Date&amp;Time</b> settings.</li> <li>Make sure the SNTP time server settings are configured correctly so the time matches the time used for authentication by Kerberos or NTLMv2. If there is no SNTP server, make sure the <b>Date&amp;Time</b> and <b>Time Zone</b> settings are set correctly using Web Based Management or the control panel so the machine matches the time being used by the server providing the authentication.</li> </ul> |
| Check User ID and Password.   | The Kerberos Authentication error.  | Make sure you have entered a correct user name and a password for the Kerberos server. For more information on the Kerberos server settings, contact your network administrator.  |
|   | The date, time and time zone settings of the Brother machine are not correct.   | Confirm your machine's date, time, and time zone settings.  |
|   | The DNS server configuration is not correct.  | Contact your network administrator for the information on the DNS server settings.  |
|   | The Brother machine cannot connect to the Kerberos server.  | Contact your network administrator for the information on the Kerberos server settings.   |
| Connection Error  | Other devices are trying to connect to the Wi-Fi Direct network at the same time.   | Make sure there are no other devices trying to connect to the Wi-Fi Direct network, and then try to configure the Wi-Fi Direct settings again.  |
| Connection Failed   | The Brother machine and your mobile device cannot communicate during the Wi-Fi Direct network configuration.                                    | <ul style="list-style-type: none"> <li>Move the mobile device closer to your Brother machine.</li> <li>Move your Brother machine and the mobile device to an obstruction-free area.</li> <li>If you are using the PIN Method of WPS, make sure you have entered the correct PIN.</li> </ul>   |
| File Access Error, contact your administrator.                          | The Brother machine cannot access the destination folder for the Store Print Log to Network feature.  | <ul style="list-style-type: none"> <li>Make sure the stored directory name is correct.</li> <li>Make sure the stored directory is write-enabled.</li> <li>Make sure the file is not locked.</li> </ul>  |
|   | In Web Based Management, you have selected the <b>Cancel Print</b> option in the <b>Error Detection Setting of Store Print Log to Network</b> . | Wait for about 60 seconds until this message disappears from the LCD.   |
| No Device   | When configuring the Wi-Fi Direct network, the Brother  | <ul style="list-style-type: none"> <li>Make sure your machine and mobile device are in the Wi-Fi Direct mode.</li> </ul>  |

| Error Messages                                 | Cause  | Action   |
|--|--|--|
|  | machine cannot find your mobile device.  | <ul style="list-style-type: none"> <li>• Move the mobile device closer to your Brother machine.</li> <li>• Move your Brother machine and the mobile device to an obstruction-free area.</li> <li>• If you are manually configuring the Wi-Fi Direct network, make sure you have entered the correct password.</li> <li>• If your mobile device has a configuration page for how to obtain an IP address, make sure the IP address of your mobile device has been configured via DHCP.</li> </ul> |
| Server Timeout, contact your administrator.    | The Brother machine cannot connect to the server for the Store Print Log to Network feature.                                     | <ul style="list-style-type: none"> <li>• Make sure your server address is correct.</li> <li>• Make sure your server is connected to the network.</li> <li>• Make sure the machine is connected to the network.</li> </ul>  |
| Server Timeout                                 | The Brother machine cannot connect to the LDAP server.   | <ul style="list-style-type: none"> <li>• Make sure your server address is correct.</li> <li>• Make sure your server is connected to the network.</li> <li>• Make sure the machine is connected to the network.</li> </ul>  |
|  | The Brother machine cannot connect to the Active Directory server.   | <ul style="list-style-type: none"> <li>• Make sure your server address is correct.</li> <li>• Make sure your server is connected to the network.</li> <li>• Make sure the machine is connected to the network.</li> </ul>  |
| Wrong Date & Time, contact your administrator. | The Brother machine does not obtain the time from the SNTP time server or you have not configured the Date&Time for the machine. | <ul style="list-style-type: none"> <li>• Make sure the settings to access the SNTP time server are configured correctly in Web Based Management.</li> <li>• Confirm the <b>Date&amp;Time</b> settings of your machine are correct in Web Based Management.</li> </ul>  |
| Internal Error                                 | The Brother machine's LDAP protocol is disabled.   | Confirm your authentication method, and then enable the necessary protocol setting in the Web Based Management.  |
|  | The Brother machine's CIFS protocol is disabled.   |  |



## Related Information

- [Network Problems](#)

### Related Topics:

- [Print the Network Configuration Report](#)

## Use the Network Connection Repair Tool (Windows)

Use the Network Connection Repair Tool to fix the Brother machine's network settings. It will assign the correct IP address and Subnet Mask.

Make sure your machine is turned on and is connected to the same network as your computer.

1. Launch  (**Brother Utilities**), and then click the drop-down list and select your model name (if not already selected).
2. Click **Tools** in the left navigation bar, and then click **Network Connection Repair Tool**.
3. Follow the on-screen instructions.
4. Check the diagnosis by printing the Network Configuration Report or the Printer Settings page.



The Network Connection Repair Tool will start automatically if you select the **Enable Connection Repair Tool** option in the Status Monitor. Right-click the Status Monitor screen, and then click **Other Settings > Enable Connection Repair Tool**. This is not recommended when your network administrator has set the IP address to Static, since it will automatically change the IP address.

If the correct IP address and the Subnet Mask are still not assigned even after using the Network Connection Repair Tool, ask your network administrator for this information.



### Related Information

- [Network Problems](#)

#### Related Topics:

- [Print the Network Configuration Report](#)
- [My Machine Cannot Print, Scan, or PC-FAX Receive over the Network](#)
- [I Want to Check that My Network Devices are Working Correctly](#)



## Check Your Machine's Network Settings

- [Print the Network Configuration Report](#)
- [Change Machine Settings from Your Computer](#)

## If You Are Having Difficulty with Your Machine's Network

If you think there is a problem with your machine's network environment, check the following topics. You can correct most problems yourself.

If you need additional help, visit [support.brother.com](http://support.brother.com) and click the **FAQs & Troubleshooting** page.

- [I Cannot Complete the Wireless Network Setup Configuration](#)
- [My Machine Cannot Print, Scan, or PC-FAX Receive over the Network](#)
- [I Want to Check that My Network Devices are Working Correctly](#)

## I Cannot Complete the Wireless Network Setup Configuration

### NOTE

The wireless network connection can be used only when the optional Wireless Module is installed.

Turn your wireless router off and back on. Then, try to configure the wireless settings again. If you are unable to resolve the problem, follow the instructions below:

Investigate the problem using the WLAN Report.

| Cause  | Action   | Interface    |
|--|--|--------------|
| Your security settings (SSID/ Network Key) are not correct.  | <p>Confirm the security settings using <b>Wireless Setup Helper</b> (Windows). For more information and to download the utility, go to your model's <b>Downloads</b> page at <a href="http://support.brother.com">support.brother.com</a>.</p> <p>Select and confirm that you are using the correct security settings.</p> <ul style="list-style-type: none"> <li>- See the instructions supplied with your wireless LAN access point/router for information on how to find the security settings.</li> <li>- The manufacturer's name or model number of the wireless LAN access point/router may be used as the default security settings.</li> <li>- Consult with the access point/router manufacturer, your Internet provider, or network administrator.</li> </ul>   | Wireless     |
| Your Brother machine's MAC address is not allowed.   | <p>Confirm that the Brother machine's MAC Address is allowed in the filter.</p> <p>You can find the MAC Address on your Brother machine's control panel.</p>   | Wireless     |
| Your wireless LAN access point/router is in stealth mode (not broadcasting the SSID).  | <ul style="list-style-type: none"> <li>• Enter the correct SSID or Network Key manually.</li> <li>• Check the SSID or the Network Key in the instructions supplied with your wireless LAN access point/router and reconfigure the wireless network setup.</li> </ul>   | Wireless     |
| Your machine is trying to connect to a 5 GHz Wi-Fi network. The current channel set on your wireless LAN access point/router is not supported. | <p>Change the channel on your wireless LAN access point/router to a channel supported by your machine.</p> <ol style="list-style-type: none"> <li>1. Confirm the channels supported by your machine. Go to <a href="http://support.brother.com/manuals">support.brother.com/manuals</a>, select your model, scroll to the <b>Appendix</b> section, and select the <b>Channels Supported by Brother Machines for 5 GHz Wi-Fi Networks</b> document.</li> <li>2. Check your wireless LAN access point/router's channel setting. Make sure it is set to one of the channels supported by your machine, and not set to "Auto" or "Automatic". For more information about changing the channel setting, see the instructions supplied with your wireless LAN access point/router.</li> <li>3. Try to connect your machine to your Wi-Fi network again.</li> </ol> | Wireless     |
| Your security settings (SSID/ password) are not correct.   | <p>Confirm the SSID and password.</p> <p>When you are configuring the network manually, the SSID and password are displayed on your Brother machine. If your mobile device supports the manual configuration, the SSID and password will be displayed on your mobile device's screen.</p>  | Wi-Fi Direct |
| You are using Android™ 4.0.  | <p>If your mobile device disconnects (approximately six minutes after using Wi-Fi Direct), try the one-push configuration using WPS (recommended) and set the Brother machine as a Group Owner.</p>  | Wi-Fi Direct |
| Your Brother machine is placed too far from your mobile device.  | <p>Move your Brother machine within about 3.3 feet (1 metre) of the mobile device when you configure the Wi-Fi Direct network settings.</p>  | Wi-Fi Direct |

| Cause   | Action  | Interface    |
|---|---|--------------|
| There are some obstructions (walls or furniture, for example) between your machine and the mobile device.   | Move your Brother machine to an obstruction-free area.  | Wi-Fi Direct |
| There is a wireless computer, Bluetooth®-supported device, microwave oven, or digital cordless phone near the Brother machine or the mobile device. | Move other devices away from the Brother machine or the mobile device.  | Wi-Fi Direct |
| You have checked and tried all of the above, but your Brother machine still cannot complete the Wi-Fi Direct configuration.                         | <ul style="list-style-type: none"> <li>• Turn your Brother machine off and back on. Then, try to configure the Wi-Fi Direct settings again.</li> <li>• If you are using your Brother machine as a client, confirm how many devices are allowed in the current Wi-Fi Direct network, and then check how many devices are connected.</li> </ul> | Wi-Fi Direct |

### For Windows

If your wireless connection has been interrupted, and you have checked and tried all of the above, we recommend using the Network Connection Repair Tool.



### Related Information

- [If You Are Having Difficulty with Your Machine's Network](#)

#### Related Topics:



- [Configure Your Machine for a Wireless Network When the SSID Is Not Broadcast](#)
- [Use Wi-Fi Direct®](#)

## My Machine Cannot Print, Scan, or PC-FAX Receive over the Network

### NOTE

The wireless network connection can be used only when the optional Wireless Module is installed.

| Cause   | Action   | Interface      |
|---|--|----------------|
| Your security software blocks your machine's access to the network. (The Network scanning feature does not work. )                | <ul style="list-style-type: none"> <li>• Windows<br/>Configure the third-party Security/Firewall Software to allow Network scanning. To add port 54925 for Network scanning, type the information below:                             <ul style="list-style-type: none"> <li>- In <b>Name</b>:<br/>Type any description, for example Brother NetScan.</li> <li>- In <b>Port number</b>:<br/>Type 54925.</li> <li>- In <b>Protocol</b>:<br/>UDP is selected.</li> </ul>                             See the instruction manual that came with your third-party Security/Firewall Software or contact the software manufacturer.                         </li> <li>• Mac<br/>(Brother iPrint&amp;Scan)<br/>In the <b>Finder</b> menu bar, click <b>Go &gt; Applications</b>, and then double-click the Brother iPrint&amp;Scan icon. The Brother iPrint&amp;Scan window appears. Click the <b>Select your Machine</b> button, and then follow the on-screen instructions to reselect your network machine.</li> </ul> | Wired/Wireless |
| Your security software blocks your machine's access to the network. (The network PC-Fax Receive feature does not work.) (Windows) | <p>Set the third-party Security/Firewall Software to allow PC-FAX Rx. To add port 54926 for Network PC-FAX Rx, type the information below:</p> <ul style="list-style-type: none"> <li>• In <b>Name</b>:<br/>Type any description, for example Brother PC-FAX Rx.</li> <li>• In <b>Port number</b>:<br/>Type 54926.</li> <li>• In <b>Protocol</b>:<br/>UDP is selected.</li> </ul> <p>See the instruction manual that came with your third-party Security/Firewall Software or contact the software manufacturer.</p>   | Wired/Wireless |
| Your security software blocks your machine's access to the network.   | <p>Some security software might block access without showing a security alert dialog box even after successful installation.</p> <p>To allow access, see the instructions for your security software or ask the software manufacturer.</p>   | Wired/Wireless |
| Your Brother machine was not assigned an available IP address.  | <ul style="list-style-type: none"> <li>• Confirm the IP address and the Subnet Mask.<br/>Verify that both the IP addresses and Subnet Masks of your computer and the Brother machine are correct and located on the same network.<br/>For more information about how to verify the IP address and the Subnet Mask, ask your network administrator.</li> <li>• Windows<br/>Confirm the IP address and the Subnet Mask using the Network Connection Repair Tool.</li> </ul>  | Wired/Wireless |
| The failed print job is still in your computer's print queue.   | <ul style="list-style-type: none"> <li>• If the failed print job is still in your computer's print queue, delete it.</li> <li>• Otherwise, double-click the printer icon in the following folder and cancel all documents:</li> </ul>  | Wired/Wireless |

| Cause  | Action   | Interface |
|--|--|-----------|
|  | <ul style="list-style-type: none"> <li>- Windows 10, Windows Server 2016, and Windows Server 2019<br/>Click  &gt; <b>Windows System</b> &gt; <b>Control Panel</b>. In the <b>Hardware and Sound</b> group, click <b>View devices and printers</b>.</li> <li>- Windows 8.1<br/>Move your mouse to the lower right corner of your desktop. When the menu bar appears, click <b>Settings</b> &gt; <b>Control Panel</b>. In the <b>Hardware and Sound</b> group, click <b>View devices and printers</b>.</li> <li>- Windows Server 2012 R2<br/>Click <b>Control Panel</b> on the <b>Start</b> screen. In the <b>Hardware</b> group, click <b>View devices and printers</b>.</li> <li>- Windows Server 2012<br/>Move your mouse to the lower right corner of your desktop. When the menu bar appears, click <b>Settings</b> &gt; <b>Control Panel</b>. In the <b>Hardware</b> group, click <b>View devices and printers</b> &gt; <b>Printers</b>.</li> <li>- Windows 7<br/>Click  (<b>Start</b>) &gt; <b>Devices and Printers</b>.</li> <li>- Windows Server 2008<br/>Click <b>Start</b> &gt; <b>Control Panel</b> &gt; <b>Printers</b>.</li> <li>- Mac<br/>Click <b>System Preferences</b> &gt; <b>Printers &amp; Scanners</b>.</li> </ul> |           |
| Your machine is not connected to the wireless network. | Print the WLAN Report to check the error code on the printed report.<br>See <i>Related Information: Print the WLAN Report</i> .  | Wireless  |

If you have checked and tried all of the above, but your machine still cannot print and scan, uninstall the drivers (Windows) and the software and reinstall the latest ones.



## Related Information

- [If You Are Having Difficulty with Your Machine's Network](#)

### Related Topics:

- [Print the WLAN Report](#)
- [Wireless LAN Report Error Codes](#)
- [Use the Network Connection Repair Tool \(Windows\)](#)
- [I Want to Check that My Network Devices are Working Correctly](#)

## I Want to Check that My Network Devices are Working Correctly

### NOTE

The wireless network connection can be used only when the optional Wireless Module is installed.

| Check  | Action   | Interface      |
|--|--|----------------|
| Check that your Brother machine, access point/router, or network hub is turned on.             | <b>Check the following:</b> <ul style="list-style-type: none"> <li>The power cord is connected correctly and the Brother machine is turned on.</li> <li>The access point/router or hub is turned on and its link LED is blinking.</li> <li>All protective packaging has been removed from the machine.</li> <li>The toner cartridge and drum unit are installed correctly.</li> <li>The machine's cover is fully closed.</li> <li>Paper is inserted correctly in the paper tray.</li> <li>(For wired networks) A network cable is securely connected to the Brother machine and to the router or hub.</li> </ul>   | Wired/Wireless |
| Check the <b>Link Status</b> in the Network Configuration Report or the Printer Settings page. | Print the Network Configuration Report and check that <b>Ethernet Link Status</b> or <b>Wireless Link Status</b> is <b>Link OK</b> .   | Wired/Wireless |
| Check that you can "ping" the Brother machine from your computer.                              | Ping the Brother machine from your computer using the IP address or the node name in the Windows command prompt or Mac Terminal application:<br>ping <ipaddress> or <nodename>. <ul style="list-style-type: none"> <li>Successful: Your Brother machine is working correctly and connected to the same network as your computer.</li> <li>Unsuccessful: Your Brother machine is not connected to the same network as your computer.</li> </ul> Windows:<br>Ask your administrator about the IP address and the subnet mask, and then use the Network Connection Repair Tool.<br>Mac:<br>Confirm that the IP address and the Subnet Mask are set correctly. | Wired/Wireless |
| Check that your Brother machine is connected to the wireless network.                          | Print the WLAN Report to check the error code on the printed report.<br>See <i>Related Information: Print the WLAN Report</i> .  | Wireless       |

If you have checked and tried all of the above but you are still having problems, see the instructions supplied with your wireless access point/router to find the SSID (Network Name) and the Network Key (Password) information and set them correctly.



### Related Information

- [If You Are Having Difficulty with Your Machine's Network](#)

#### Related Topics:

- [Print the Network Configuration Report](#)
- [Print the WLAN Report](#)
- [Wireless LAN Report Error Codes](#)
- [Use the Network Connection Repair Tool \(Windows\)](#)

- 
- My Machine Cannot Print, Scan, or PC-FAX Receive over the Network
-



## AirPrint Problems

### NOTE

The wireless network connection can be used only when the optional Wireless Module is installed.

| Difficulty   | Suggestions   |
|--|---|
| My machine is not displayed in the printer list.   | Make sure your machine is turned on.  |
|  | Make sure your machine and your mobile device or Mac are connected to the same network. |
|  | Move the mobile device closer to the wireless access point/router, or to your machine.  |
| I cannot print.  | Make sure your machine is turned on.  |
|  | Make sure your machine and your mobile device or Mac are connected to the same network. |
| I am trying to print a multiple-page document from an iOS device, but ONLY the first page is printing. | Make sure you are running the latest OS version.  |







### Related Information

- [Troubleshooting](#)

#### Related Topics:

- [AirPrint Overview](#)

## Other Problems

| Difficulties  | Suggestions  |
|---|--|
| <p>The machine will not turn on.</p>  | <p>Adverse conditions on the power connection (such as lightning or a power surge) may have triggered the machine's internal safety mechanisms. Unplug the power cord. Wait for ten minutes, then plug in the power cord and press  to turn on the machine.</p> <p>If the problem is not solved and you are using a power breaker, disconnect it to make sure it is not the problem. Plug the machine's power cord directly into a different known working wall electrical socket. If there is still no power, try a different power cable.</p>   |
| <p>The machine cannot print EPS data that includes binary with the BR-Script3 printer driver.</p> | <p><b>(Windows)</b></p> <p>To print EPS data, do the following:</p> <ol style="list-style-type: none"> <li>For Windows 10, Windows Server 2016 and Windows Server 2019:           <p>Click  &gt; <b>Windows System</b> &gt; <b>Control Panel</b>. In the <b>Hardware and Sound</b> group, click <b>View devices and printers</b>.</p> <p>For Windows 8.1 and Windows Server 2012:           <p>Move your mouse to the lower right corner of your desktop. When the menu bar appears, click <b>Settings</b> &gt; <b>Control Panel</b>. In the <b>Hardware and Sound</b><sup>1</sup> group, click <b>View devices and printers</b>.</p> <p>For Windows Server 2012 R2:           <p>Click <b>Control Panel</b> on the <b>Start</b> screen. In the <b>Hardware</b> group, click <b>View devices and printers</b>.</p> <p>For Windows 7 and Windows Server 2008 R2:           <p>Click the  <b>Start</b> button &gt; <b>Devices and Printers</b>.</p> <p>For Windows Server 2008:           <p>Click the  (<b>Start</b>) button &gt; <b>Control Panel</b> &gt; <b>Hardware and Sound</b> &gt; <b>Printers</b>.</p> </p></p></p></p></li> <li>Right-click the <b>Brother XXX-XXXX BR-Script3</b> icon, select <b>Printer properties</b>.           <hr/> <p> If <b>Brother XXX-XXXX BR-Script3</b> does not appear, right-click the <b>Brother XXX-XXXX</b> icon, select <b>Printer properties</b>, and then select <b>Brother XXX-XXXX BR-Script3</b>.</p> </li> <li>From the <b>Device Settings</b> tab, choose TBCP (Tagged binary communication protocol) in <b>Output Protocol</b>.</li> </ol> |
| <p>The Brother software cannot be installed.</p>  | <p><b>(Windows)</b></p> <p>If the Security Software warning appears on the computer screen during the installation, change the Security Software settings to permit the Brother product setup program or other program to run.</p> <p><b>(Mac)</b></p> <p>If you are using a firewall function of anti-spyware or antivirus security software, temporarily disable it and then install the Brother software.</p>   |

## Copying difficulties

| Difficulties                           | Suggestions  |
|--|--|
| Cannot make a copy.                    | Make sure you pressed Copy and the machine is in Copy mode.<br>Contact your administrator to check your Secure Function Lock Settings.   |
| Vertical black line appears in copies. | Black vertical lines on copies are typically caused by dirt or correction fluid on the glass strip, or the corona wires are dirty. Clean the glass strip and scanner glass and the white bar and white plastic above them. |
| Copies are blank.                      | Make sure you are loading the document correctly.  |

## Scanning difficulties

| Difficulties  | Suggestions  |
|---|--|
| TWAIN or WIA errors appear when starting to scan. (Windows) | Make sure the Brother TWAIN or WIA driver is selected as the primary source in your scanning application. For example, in Nuance™ PaperPort™ 14SE, click <b>Desktop &gt; Scan Settings &gt; Select</b> to select the Brother TWAIN/WIA driver. |
| OCR does not work.  | Try increasing the scanning resolution.  |
| Cannot scan.  | Contact your administrator to check your Secure Function Lock Settings.  |

## Software difficulties

| Difficulties                      | Suggestions   |
|-----------------------------------|---|
| Cannot install software or print. | (Windows )<br>Run the install program again. This program will repair and reinstall the software. |



### Related Information

- [Troubleshooting](#)

## Check the Machine Information

Follow these instructions to check your machine's serial number and firmware version.

1. Press  [Settings] > [All Settings] > [Machine Info.].



If your machine displays the [All Settings] menu on the Home screen, skip the [Settings] menu.

2. Press one of the following options:

| Option              | Description  |
|---------------------|--|
| Serial No.          | Check your machine's serial number.                                |
| Firmware Version    | Check your machine's firmware version.                             |
| Firmware Update     | Update your machine to the latest firmware.                        |
| Firmware Auto Check | View firmware information on the Main Home screen.                 |
| Page Counter        | Check the total number of pages the machine has printed.           |
| Parts Life          | Check the percentage of the supplies' life that remains available. |

3. Press .



### Related Information

- [Troubleshooting](#)

## Reset Your Machine

1. Press  [Settings] > [All Settings] > [Initial Setup] > [Reset].



If your machine displays the [All Settings] menu on the Home screen, skip the [Settings] menu.

2. Press the reset function you want to use.



- The network settings, the security settings and address book data will not be reset by the [Machine Reset].
- If you discard or transfer the machine, we recommend accomplishment of the [Factory Reset] to erase the personal data in the machine.

3. [Machine will reboot after resetting. Press [OK] for 2 seconds to confirm.] appears. Press [OK] for two seconds to confirm.



You can also reset the Network settings by pressing  [Settings] > [All Settings] > [Network] > [Network Reset].

The machine will restart.



### Related Information

- [Troubleshooting](#)
  - [Reset Functions Overview](#)

### Related Topics:

- [Reset the Network Settings to the Factory Settings](#)

## Reset Functions Overview

The following reset functions are available:



Unplug the interface cable before you choose the Network Settings Reset function, All Settings Reset function, or Factory Reset function.

### 1. Machine Reset

Reset all the machine's settings that you have changed, such as Date and Time and Ring Delay.

The Address Book, fax reports, and Call history will remain. (For models with the fax)

### 2. Network Settings Reset (For Network Models)

Reset the print server back to its default factory settings (includes Password and IP Address information).

### 3. Address Book and Fax Settings Reset (For models with the fax)

This function resets the following settings:

- Address Book  
(Addresses and Groups)
- Programmed fax jobs in the memory  
(Delayed Fax)
- Station ID  
(name and number)
- Cover Page Message
- Fax receive settings  
(Remote Access Code, Fax Storage, Fax Forwarding, and PC-Fax Receive (Windows only))
- Report  
(Transmission Verification Report / Tel Index List / Fax Journal)

### 4. All Settings Reset

Reset all the machine's settings back to the settings that were set at the factory.

All Settings Reset takes less time than Factory Reset.

### 5. Factory Reset

Use the Settings Reset function to reset all of the machine's settings to the settings originally set at the factory.

Factory Reset takes more time than All Settings Reset.

We strongly recommend you perform this operation when you dispose of the machine.



## Related Information

- [Reset Your Machine](#)

## **Routine Maintenance**

- [Replace Supplies](#)
- [Clean the Machine](#)
- [Correct Colour Printing](#)
- [Check the Remaining Part Life](#)
- [Pack and Ship Your Machine](#)
- [Replace Periodic Maintenance Parts](#)

## Replace Supplies

You must replace supplies when the machine indicates that the life of the supply is over.

Using non-Brother supplies may affect the print quality, hardware performance, machine reliability, and may void the machine's warranty. The toner cartridge and drum unit are two separate supplies. Make sure both are installed as an assembly. The model name of supplies may vary depending on the country.

### IMPORTANT

To avoid print quality problems, DO NOT touch the shaded parts shown in the illustrations.

#### Toner Cartridge

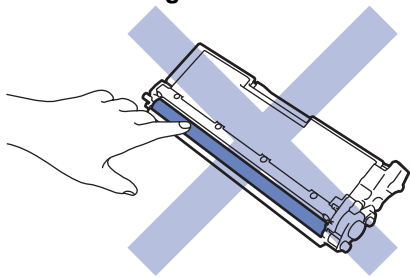

#### Drum Unit

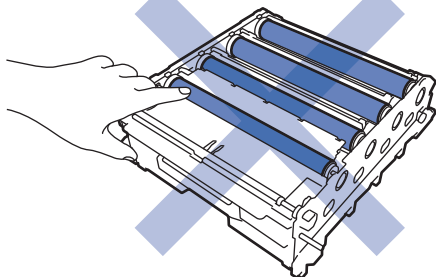
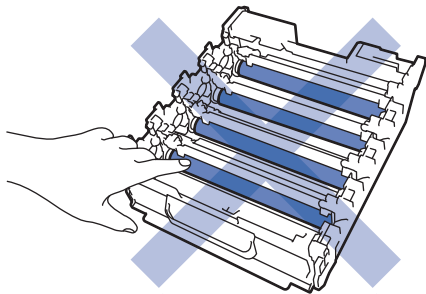

#### Belt Unit

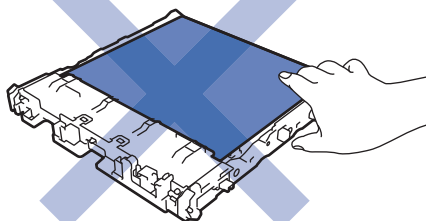
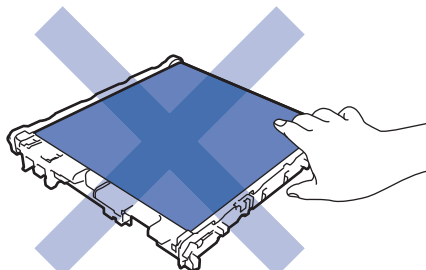



---

## Waste Toner Box

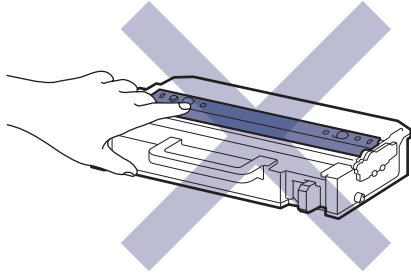

---

## NOTE

- Be sure to seal the used supplies tightly in a bag so that toner powder does not spill out of the cartridge.
- Visit [www.brother.com/original](http://www.brother.com/original) for instructions on how to return your used supplies to the Brother collection and recycling program. If your local Brother office does not have the collection program yet, or you choose not to return your used supply, discard the used supply according to local regulations, keeping it separate from domestic waste. If you have questions, contact your local waste disposal office.
- We recommend placing both the new and the used supplies on a piece of paper to prevent accidentally spilling or scattering the contents.
- Using paper that is not a direct equivalent for a recommended print media may reduce the life of supplies and machine parts.
- The projected life for each of the toner cartridges is based on ISO/IEC 19798. Frequency of replacement will vary depending on the print volume, percentage of coverage, types of media used, and powering on/off the machine.
- Frequency of replacing supplies except toner cartridges will vary depending on the print volume, types of media used, and powering on/off the machine.
- Handle the toner cartridge carefully. If toner scatters on your hands or clothes, immediately wipe or wash it off with cold water.



DO NOT touch the IC chip surfaces on the toner cartridge and the belt unit. Contamination and damage may interfere with the detection of each unit.

---



## Related Information

- [Routine Maintenance](#)
  - [Replace the Toner Cartridge](#)
  - [Replace the Drum Unit](#)
  - [Replace the Belt Unit](#)
  - [Replace the Waste Toner Box](#)

### Related Topics:

- [Error and Maintenance Messages](#)
-

## Replace the Toner Cartridge

Before starting the replacement procedure, see *Related Information: Replace Supplies*.

1. Make sure the machine is turned on.
2. Press the front cover release button and open the front cover.

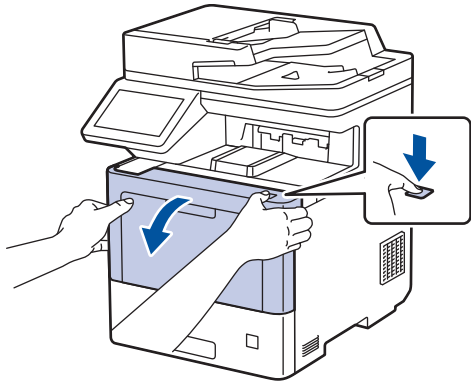

3. Hold the drum unit's green labeled handle. Pull the drum unit out of the machine until it stops.

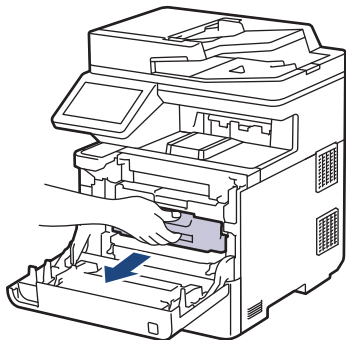

### **CAUTION**

We recommend placing the toner cartridge and drum unit assembly on a clean, flat surface with disposable paper underneath it in case you accidentally spill or scatter toner.

4. Hold the handle of the toner cartridge and pull the toner cartridge up and out of the drum unit. Repeat this for all toner cartridges.

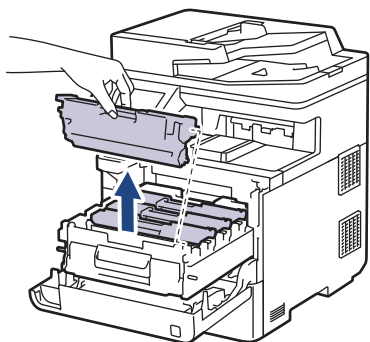

5. Clean the corona wire inside the drum unit by gently sliding the green tab from left to right and right to left several times. Repeat this for all the corona wires.

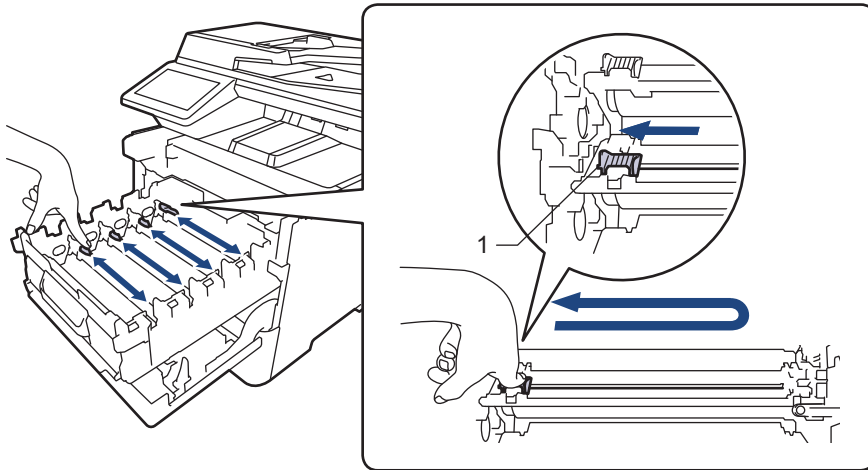

 To avoid poor print quality, be sure to lock the green tab into the home position (1), flush left with the left side of the drum.

6. Unpack the new toner cartridge.  
7. Remove the protective materials.

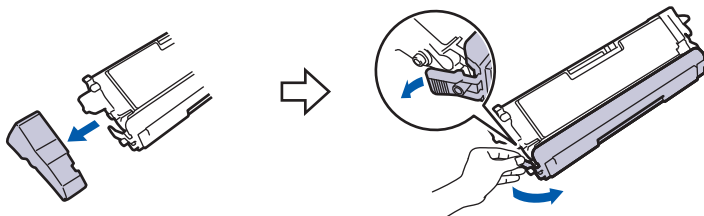

8. Insert the toner cartridge into the drum unit. Make sure that you match the toner cartridge colour to the same colour label on the drum unit. Repeat this for all toner cartridges.

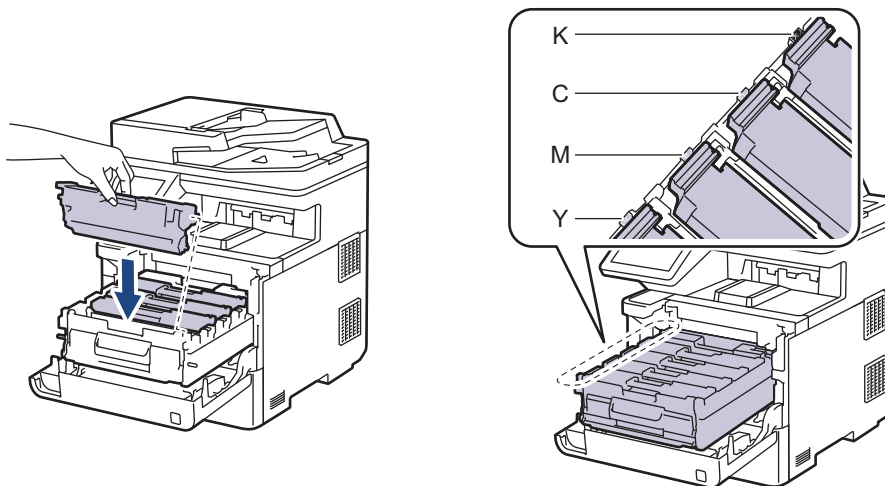

- K: Black
- C: Cyan
- M: Magenta
- Y: Yellow

 Make sure you put the toner cartridge in correctly or it may separate from the drum unit.

---

9. Using the green labeled handle, push the drum unit back into the machine until it locks in place.

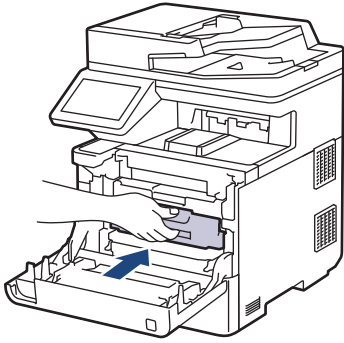

10. Close the machine's front cover.



- 
- After replacing a toner cartridge, **DO NOT** turn the machine off or open the front cover until the machine's display returns to Ready Mode.
  - The toner cartridge that comes with your Brother machine is an Inbox toner cartridge.
  - We recommend keeping a new toner cartridge ready for use when you see the Toner Low warning.
  - To ensure high quality printing, we recommend using only Brother Original toner cartridges. When you want to buy toner cartridges, contact Brother customer service or your local Brother dealer.
  - **DO NOT** unpack the new toner cartridge until you are ready to install it.
  - If a toner cartridge is left unpacked for a long time, the toner life will be shortened.
  - We strongly recommend you **DO NOT** refill the toner cartridge provided with your machine. We also strongly recommend you continue to use only Brother Original replacement toner cartridges. Use or attempted use of third-party toner and/or cartridges in the Brother machine may cause damage to the machine and/or may result in unsatisfactory print quality. Our limited warranty coverage does not apply to any problem that is caused by the use of third party toner and/or cartridges. To protect your investment and obtain premium performance from your machine, we strongly recommend the use of Brother Original Supplies.
- 



## Related Information

- [Replace Supplies](#)

### Related Topics:

- [Error and Maintenance Messages](#)
  - [Improve the Print Quality](#)
-

## Replace the Drum Unit

Before starting the replacement procedure, see *Related Information: Replace Supplies*.

1. Make sure the machine is turned on.
2. Press the front cover release button and open the front cover.

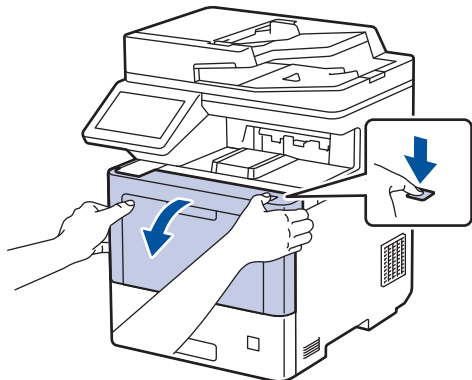

3. Hold the drum unit's green labeled handle. Pull the drum unit out of the machine until it stops.

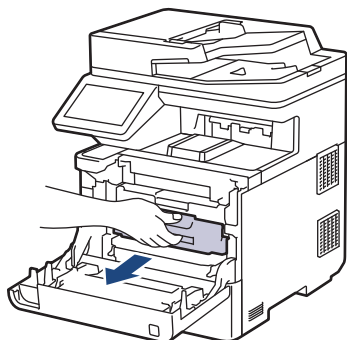

### **CAUTION**

We recommend placing the toner cartridge and drum unit assembly on a clean, flat surface with disposable paper underneath it in case you accidentally spill or scatter toner.

4. Holding the green labeled handles of the drum unit, lift the front of the drum unit and remove it from the machine.

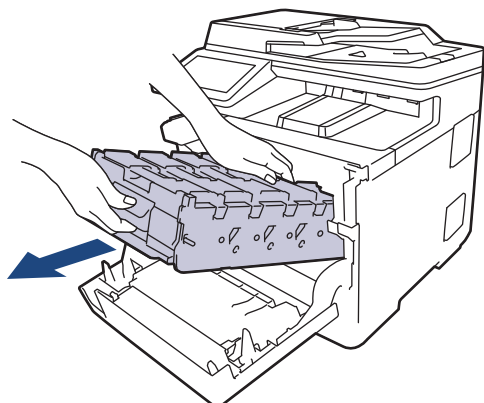

### **IMPORTANT**

Hold the handles of the drum unit when you carry it. DO NOT hold the sides of the drum unit.

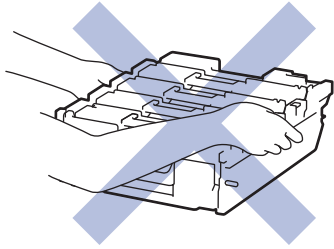

5. Unpack the new drum unit.
6. Remove the protective cover.

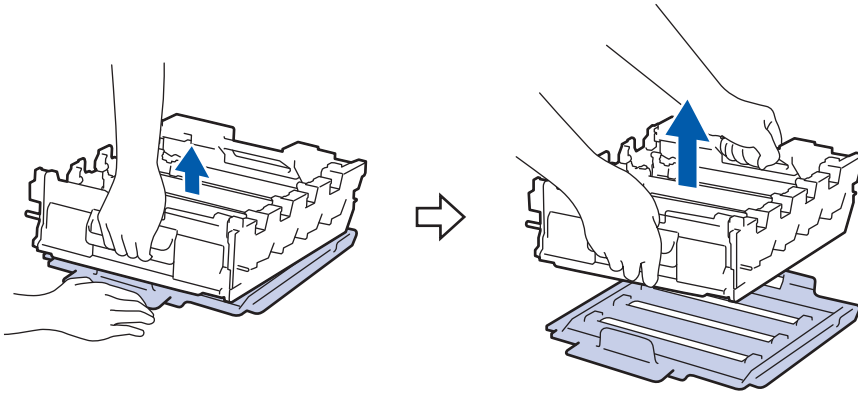

7. Hold the handle of the toner cartridge and pull the toner cartridge up and out of the drum unit. Repeat this for all toner cartridges.

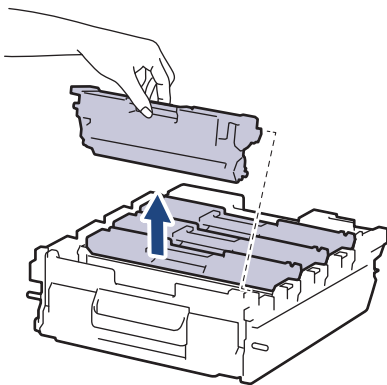

8. Reinsert the toner cartridge into the new drum unit. Make sure that you match the toner cartridge colour to the same colour label on the drum unit. Repeat this for all toner cartridges.

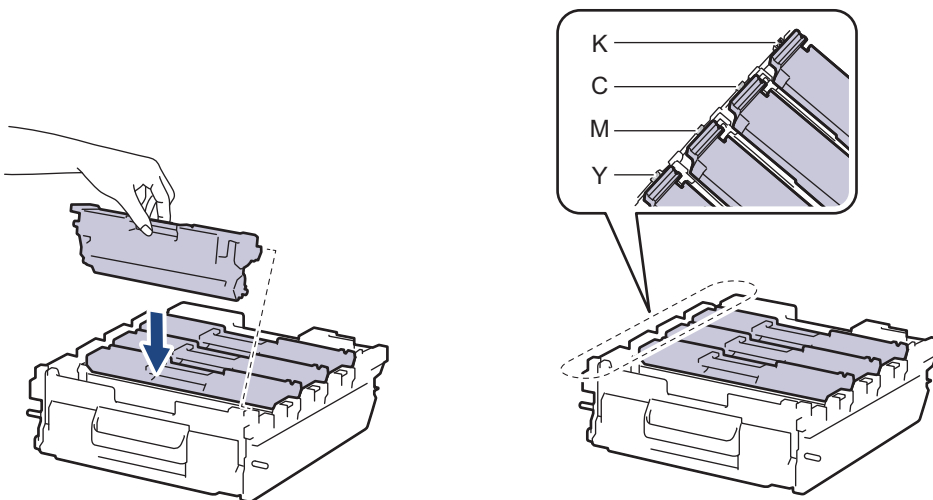

- K: Black
- C: Cyan
- M: Magenta
- Y: Yellow



Make sure you put the toner cartridge in correctly or it may separate from the drum unit.

9. Gently slide the drum unit into the machine until it stops.

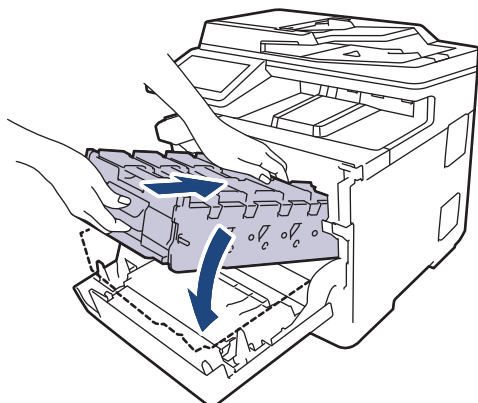

10. Using the green labeled handle, push the drum unit back into the machine until it locks in place.

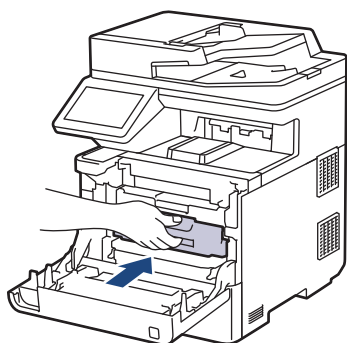

11. Close the machine's front cover.

## NOTE

- Drum wear and tear occurs due to use and rotation of the drum and interaction with paper, toner, and other materials in the paper path. In designing this product, Brother decided to use the number of rotations of the drum as a reasonable determinant of the drum life. When a drum reaches the factory-established rotation limit corresponding to the rated page yield, the product's LCD will advise you to replace the drum. The product will continue to function; however, print quality may not be optimal.
- If an unpacked drum unit is placed in direct sunlight (or artificial light for long periods of time), the unit may be damaged.
- There are many factors that determine the actual drum life, such as the temperature, humidity, type of paper, type of toner used and so on. Under ideal conditions, the average drum life is estimated at approximately 100,000 pages based on 3 pages per job [A4/letter simplex pages]. The number of pages may be affected due to a variety of factors including but not limited to media type and media size.

Because we have no control over the many factors that determine the actual drum life, we cannot guarantee a minimum number of pages that will be printed by your drum.

- For best performance, use only Brother Original toner.
- The machine should be used only in a clean, dust-free environment with adequate ventilation.

Printing with a non-Brother drum unit may reduce not only the print quality but also the quality and life of the machine itself. Warranty coverage does not apply to problems caused by the use of a non-Brother drum unit.



## Related Information

- [Replace Supplies](#)

### Related Topics:

- [Error and Maintenance Messages](#)
- [Improve the Print Quality](#)

## Replace the Belt Unit

Before starting the replacement procedure, see *Related Information: Replace Supplies*.

1. Make sure the machine is turned on.
2. Press the front cover release button and open the front cover.

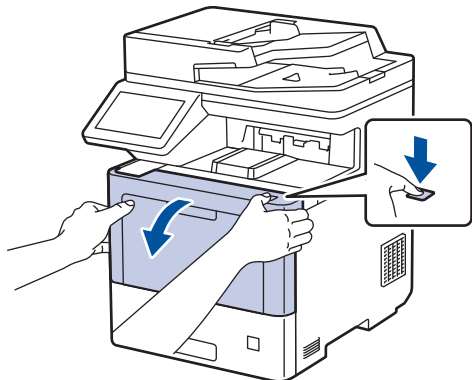

3. Hold the drum unit's green labeled handle. Pull the drum unit out of the machine until it stops.

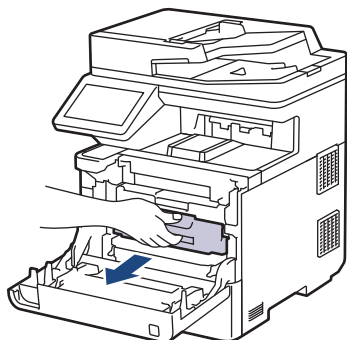

### **CAUTION**

We recommend placing the toner cartridge and drum unit assembly on a clean, flat surface with disposable paper underneath it in case you accidentally spill or scatter toner.

4. Holding the green labeled handles of the drum unit, lift the front of the drum unit and remove it from the machine.

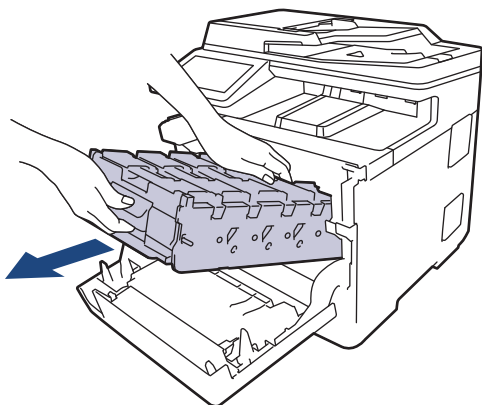

### **IMPORTANT**

Hold the handles of the drum unit when you carry it. DO NOT hold the sides of the drum unit.



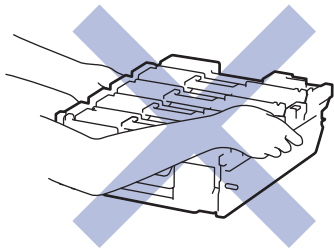

5. Push down the belt unit release lever to lift the belt unit up.

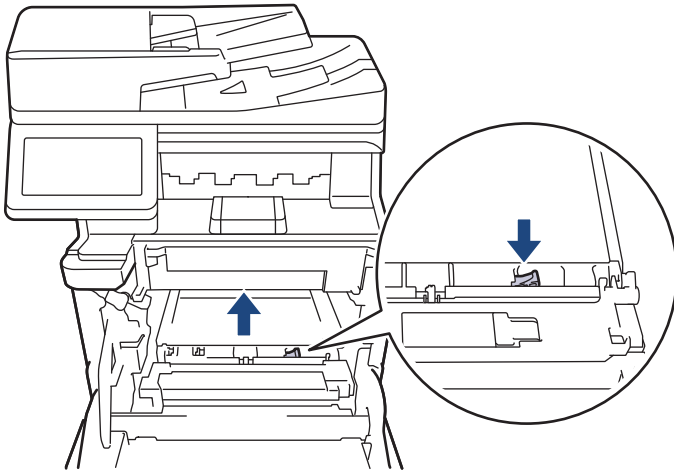

6. Hold the handle of the belt unit with both hands and lift the belt unit up, then pull it out.

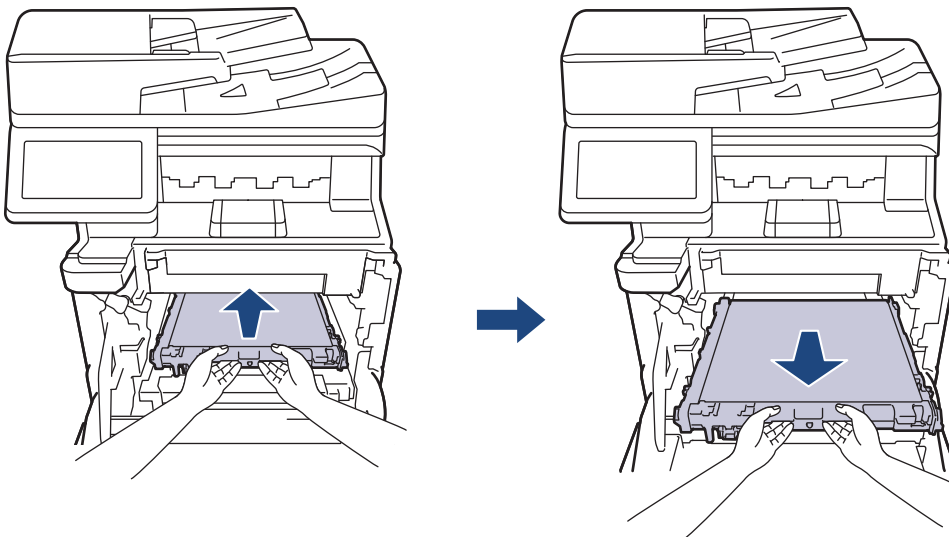

7. Unpack the new belt unit and install it in the machine. Make sure the belt unit is level and fits firmly into place until the belt unit release lever is secured.

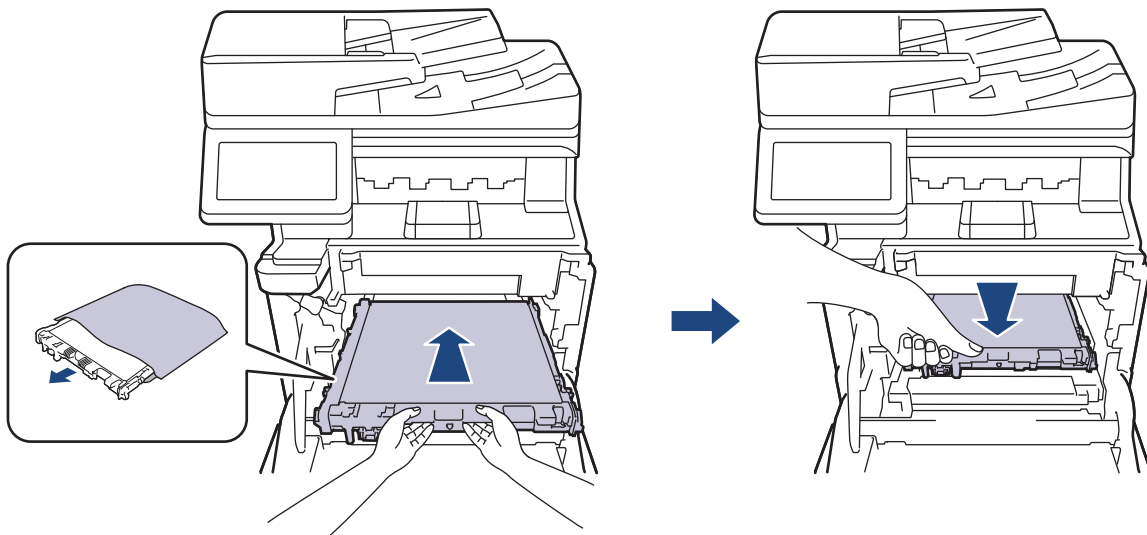

---

8. Gently slide the drum unit into the machine until it stops.

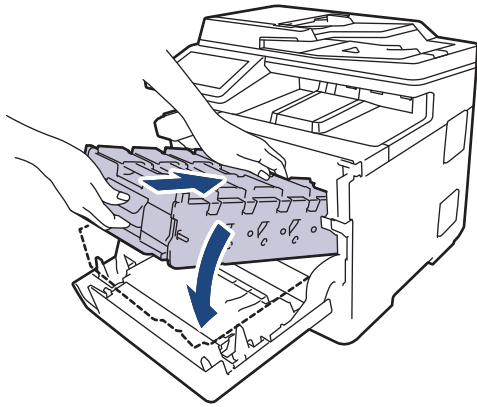

9. Using the green labeled handle, push the drum unit back into the machine until it locks in place.

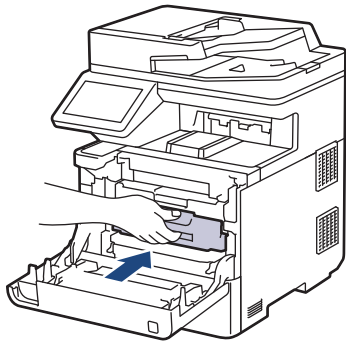

10. Close the machine's front cover.

### Related Information

- [Replace Supplies](#)

#### **Related Topics:**

- [Error and Maintenance Messages](#)
  - [Improve the Print Quality](#)
-

## Replace the Waste Toner Box

Before starting the replacement procedure, see *Related Information: Replace Supplies*.

1. Make sure the machine is turned on.
2. Press the front cover release button and open the front cover.

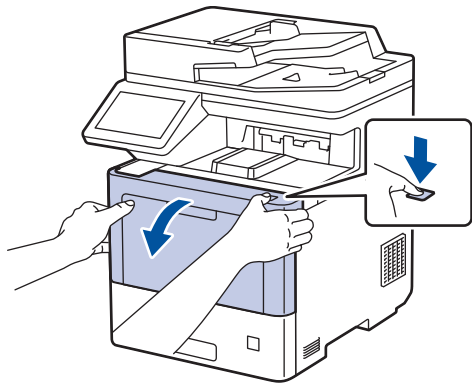

3. Hold the drum unit's green labeled handle. Pull the drum unit out of the machine until it stops.

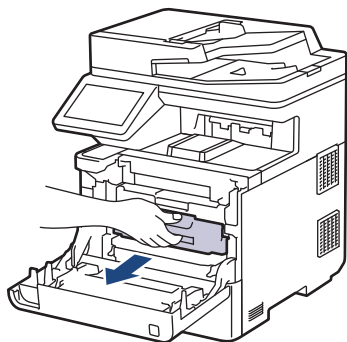

### **CAUTION**

We recommend placing the toner cartridge and drum unit assembly on a clean, flat surface with disposable paper underneath it in case you accidentally spill or scatter toner.

4. Holding the green labeled handles of the drum unit, lift the front of the drum unit and remove it from the machine.

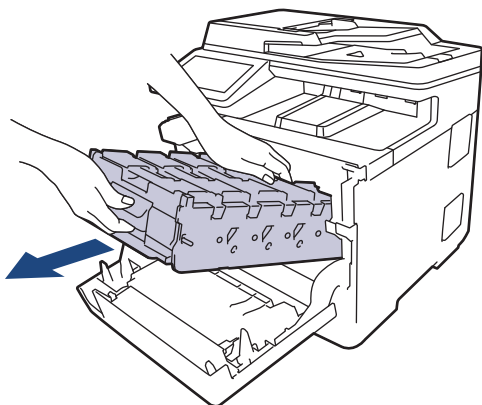

### **IMPORTANT**

Hold the handles of the drum unit when you carry it. DO NOT hold the sides of the drum unit.

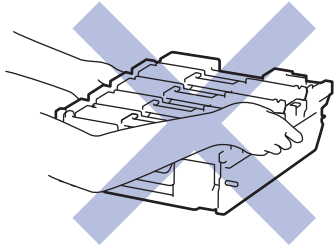

5. Push down the belt unit release lever to lift the belt unit up.

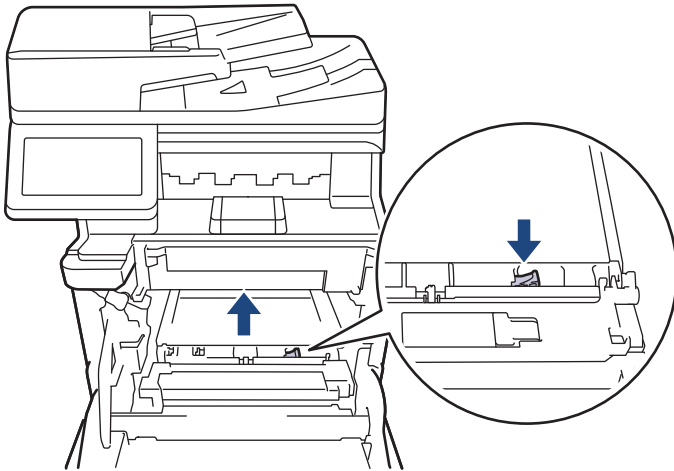

6. Hold the handle of the belt unit with both hands and lift the belt unit up, then pull it out.

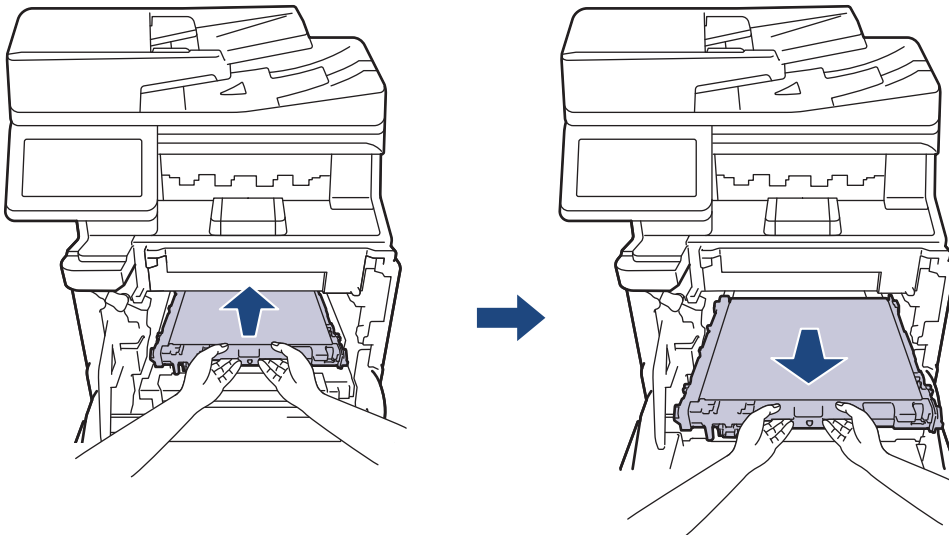

7. Remove the two pieces of orange packing material and discard them.

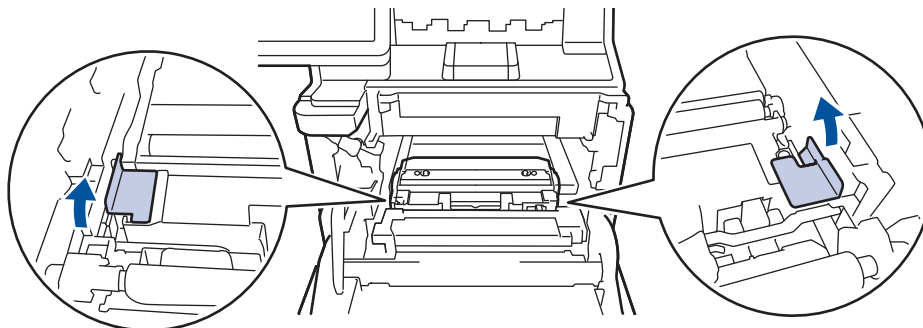

This step is only necessary when you are replacing the waste toner box for the first time, and is not required for the replacement waste toner box. The orange packing pieces are installed at the factory to protect your machine during shipment.

8. Hold the green handle of the waste toner box and remove the waste toner box from the machine.

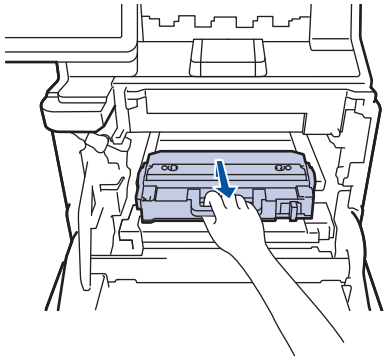

**DO NOT** reuse the waste toner box.

9. Unpack the new waste toner box and install the new waste toner box in the machine using the green handle. Make sure the waste toner box is level and fits firmly into place.

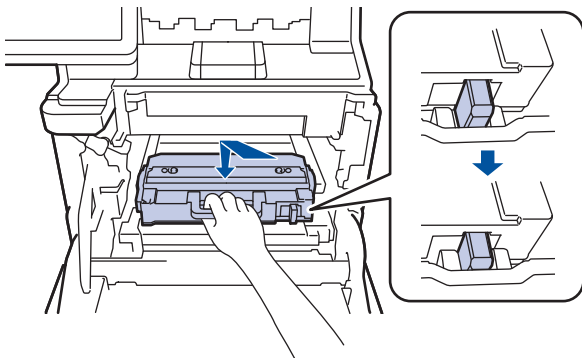

10. Slide the belt unit back into the machine. Make sure the belt unit is level and fits firmly into place, and the belt unit release lever is secured.

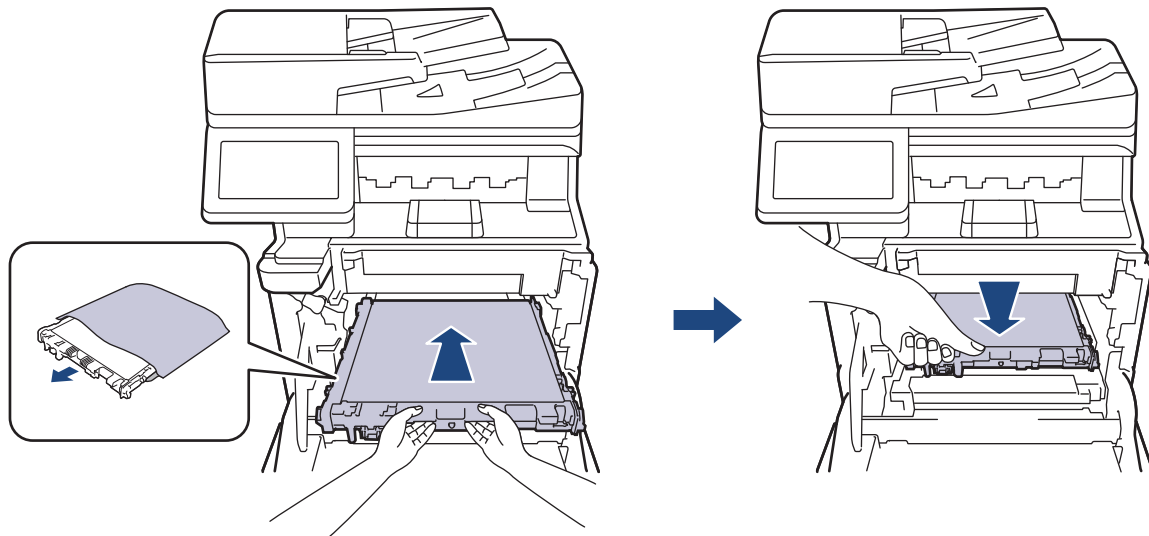

11. Gently slide the drum unit into the machine until it stops.

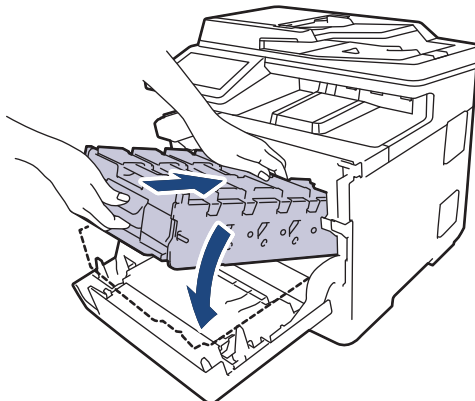

---

12. Using the green labeled handle, push the drum unit back into the machine until it locks in place.

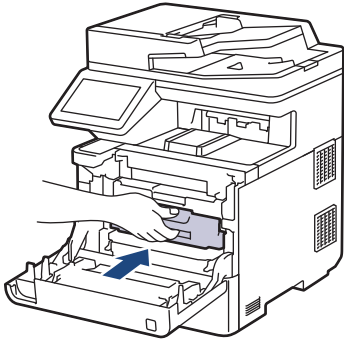

13. Close the machine's front cover.



### Related Information

- [Replace Supplies](#)

#### Related Topics:

- [Error and Maintenance Messages](#)
-

## Clean the Machine

Clean the outside and inside of the machine regularly with a dry, lint-free cloth.

When you replace the toner cartridge or the drum unit, make sure you clean the inside of the machine. If printed pages are stained with toner, clean the inside of the machine with a dry, lint-free cloth.

### WARNING

DO NOT use flammable substances, any type of spray, or an organic solvent/liquid containing alcohol or ammonia to clean the inside or outside of the product. Doing so could cause a fire. Instead, use only a dry, lint-free cloth.



### IMPORTANT

- DO NOT use isopropyl alcohol to remove dirt from the control panel. It may crack the panel.
- To avoid print quality problems, DO NOT touch the shaded parts shown in the illustrations.

#### Toner Cartridge

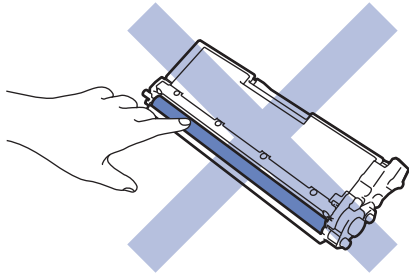

#### Drum Unit

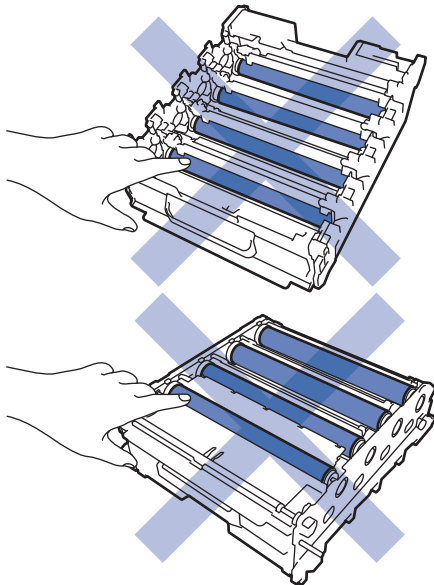

---

### Belt Unit

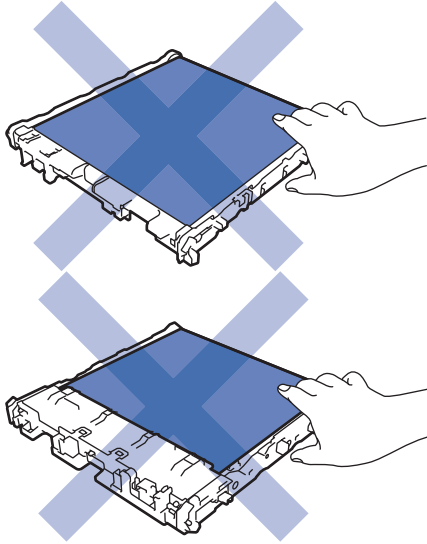

### Waste Toner Box

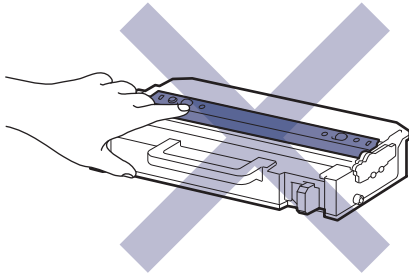

- DO NOT turn the waste toner box upside down, otherwise the toner may spill out.
  - DO NOT touch the IC chip surface of the toner cartridge and the belt unit. Contamination and damage may interfere with the detection of each unit.
- 



### Related Information

- Routine Maintenance
    - Clean the Scanner
    - Clean the Laser Scanner Windows
    - Clean the Touchscreen LCD
    - Clean the Corona Wires
    - Clean the Drum Unit
    - Clean the Paper Pick-up Rollers
-



## Clean the Scanner

Before starting the cleaning procedure, see *Related Information: Clean the Machine*.

1. Press and hold  to turn the machine off.
2. Lift the document cover (1). Clean the white plastic surface (2) and scanner glass (3) underneath it with a soft lint-free cloth moistened with water.

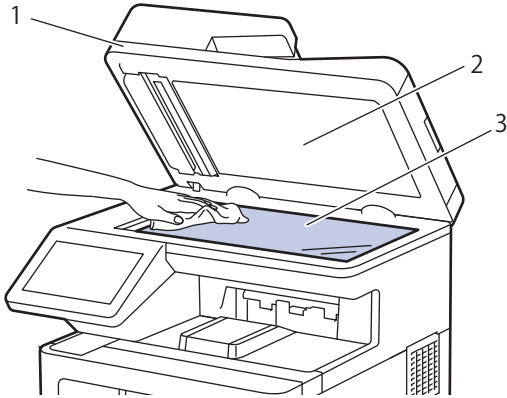

3. In the ADF unit, clean the white bar (1) and the scanner glass strip (2) underneath it with a soft lint-free cloth moistened with water.

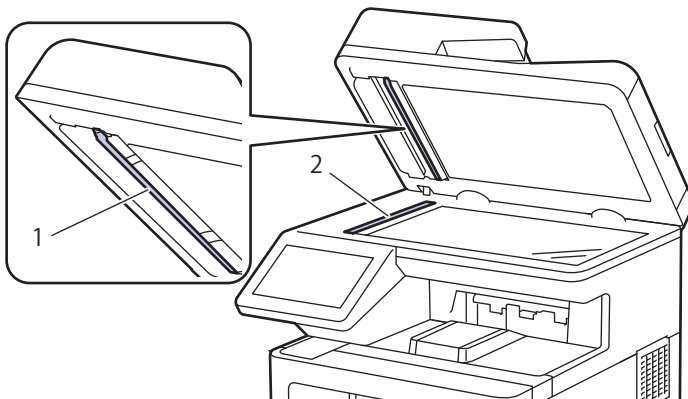

4. Open the scanner glass cover (1), and then clean the other white bar (2) and scanner glass strip (3) (supported models only).

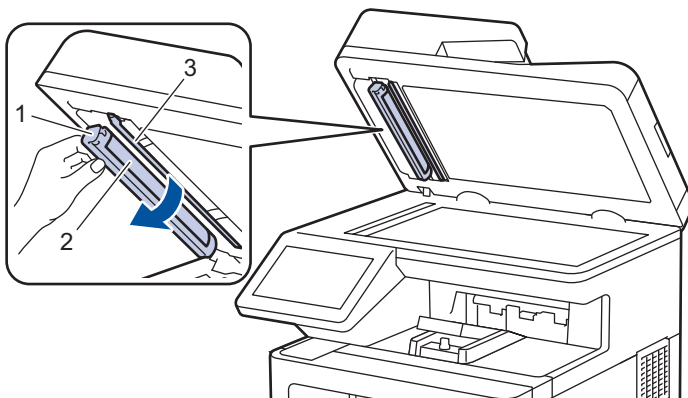

5. Close the document cover.
6. Press  to turn the machine on.

### Related Information

- [Clean the Machine](#)

## Clean the Laser Scanner Windows

Before starting the cleaning procedure, see *Related Information: Clean the Machine*.

1. Press and hold  to turn the machine off.
2. Press the front cover release button and open the front cover.

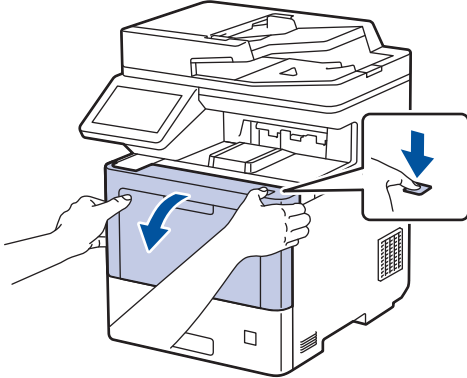

3. Hold the drum unit's green labeled handle. Pull the drum unit out of the machine until it stops.

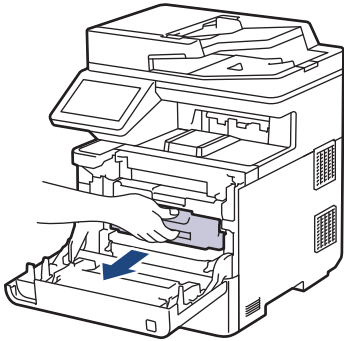

### CAUTION

We recommend placing the toner cartridge and drum unit assembly on a clean, flat surface with disposable paper underneath it in case you accidentally spill or scatter toner.

4. Holding the green labeled handles of the drum unit, lift the front of the drum unit and remove it from the machine.

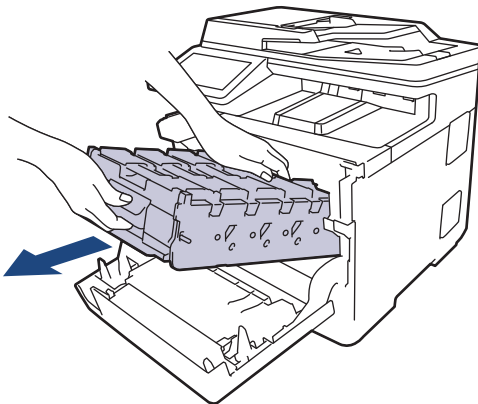

### IMPORTANT

Hold the handles of the drum unit when you carry it. DO NOT hold the sides of the drum unit.

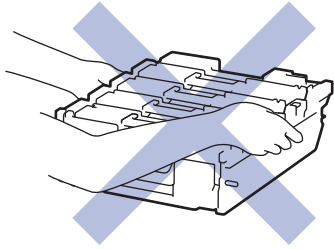

5. Wipe the four laser scanner windows (1) with a dry, soft, lint-free cloth.

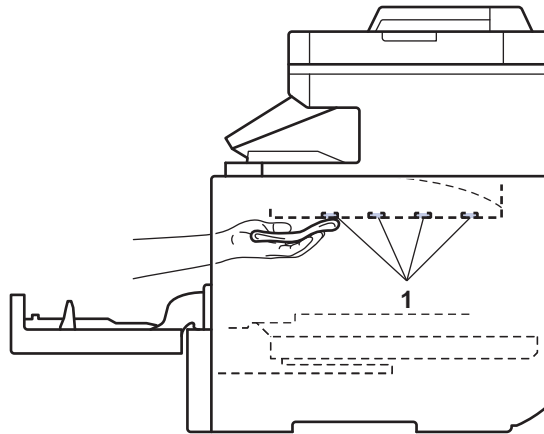
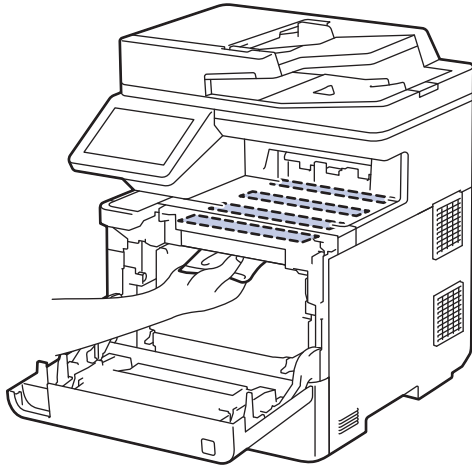

6. Gently slide the drum unit into the machine until it stops.

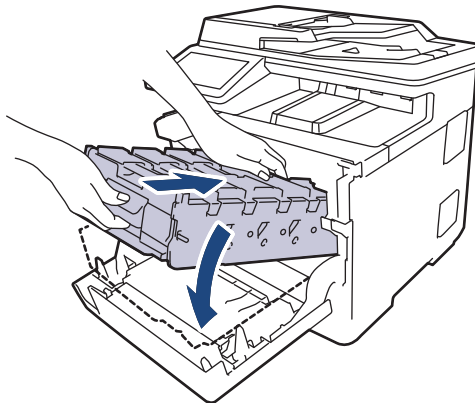

7. Using the green labeled handle, push the drum unit back into the machine until it locks in place.

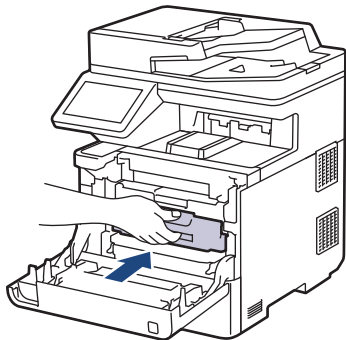

8. Close the machine's front cover.
9. Press  to turn the machine on.

### Related Information

- [Clean the Machine](#)

#### Related Topics:

- [Improve the Print Quality](#)

## Clean the Touchscreen LCD

Before starting the cleaning procedure, see *Related Information: Clean the Machine*.

### IMPORTANT

DO NOT use any type of liquid cleaners (including ethanol).

1. Press and hold  to turn the machine off.
2. Clean the touchscreen with a dry, soft lint-free cloth.

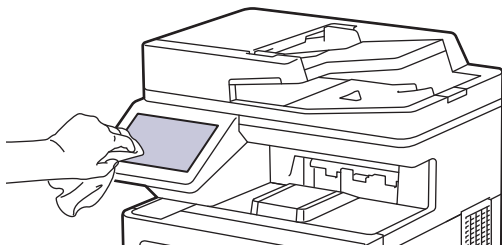

3. Press  to turn the machine on.



### Related Information

- [Clean the Machine](#)

## Clean the Corona Wires

Before starting the cleaning procedure, see *Related Information: Clean the Machine*.

1. Press the front cover release button and open the front cover.

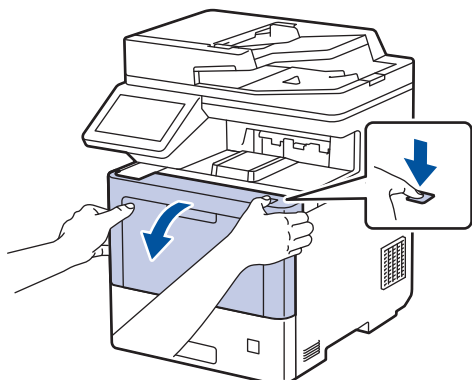

2. Hold the drum unit's green labeled handle. Pull the drum unit out of the machine until it stops.

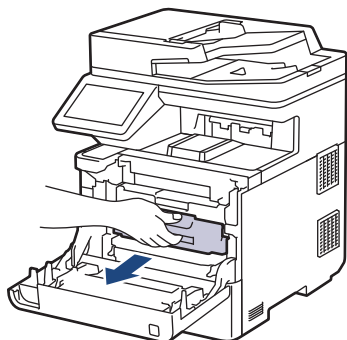

### **CAUTION**

We recommend placing the toner cartridge and drum unit assembly on a clean, flat surface with disposable paper underneath it in case you accidentally spill or scatter toner.

3. Hold the handle of the toner cartridge and pull the toner cartridge up and out of the drum unit. Repeat this for all toner cartridges.

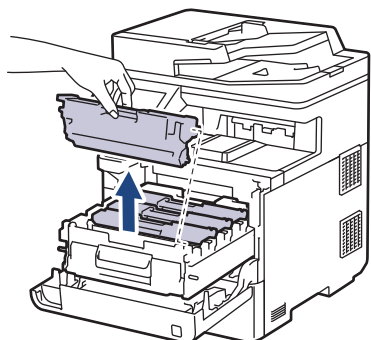

4. Clean the corona wire inside the drum unit by gently sliding the green tab from left to right and right to left several times. Repeat this for all the corona wires.

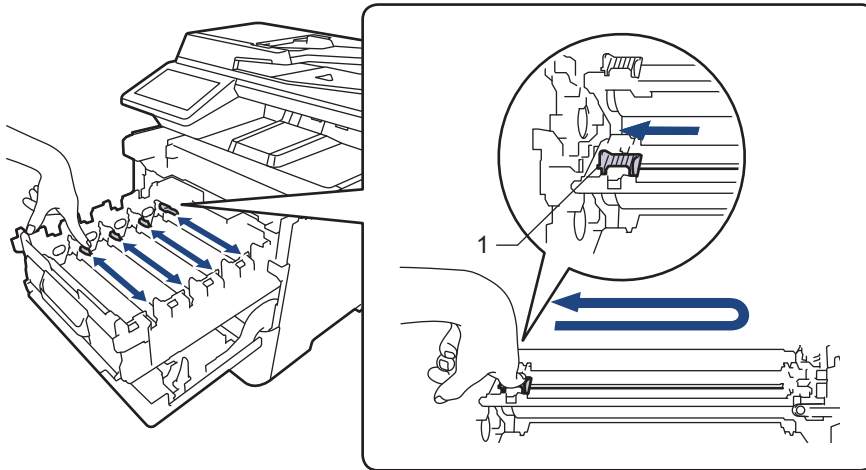

To avoid poor print quality, be sure to lock the green tab into the home position (1), flush left with the left side of the drum.

5. Insert the toner cartridge into the drum unit. Make sure that you match the toner cartridge colour to the same colour label on the drum unit. Repeat this for all toner cartridges.

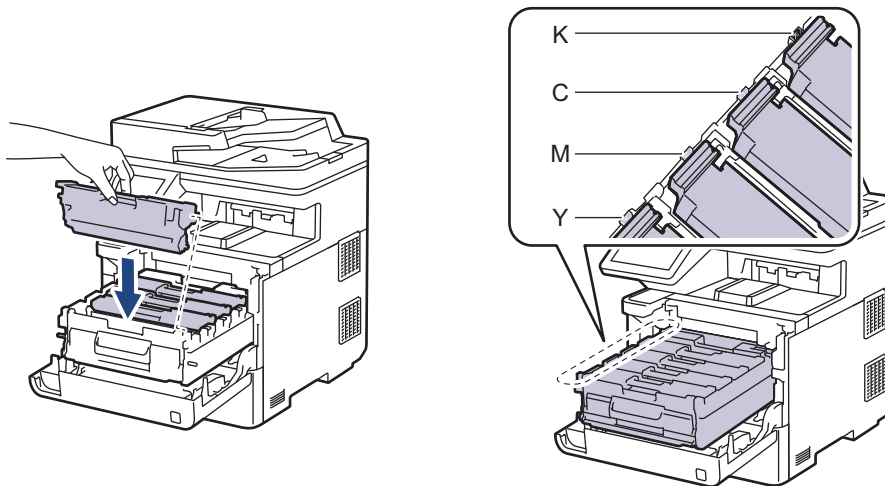

- K: Black
- C: Cyan
- M: Magenta
- Y: Yellow



Make sure you put the toner cartridge in correctly or it may separate from the drum unit.

6. Using the green labeled handle, push the drum unit back into the machine until it locks in place.

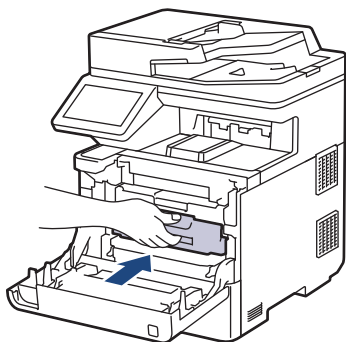

7. Close the machine's front cover.



## Related Information

- [Clean the Machine](#)

### **Related Topics:**

- [Error and Maintenance Messages](#)
-



## Clean the Drum Unit

- If your printout has black or white dots or other repeating marks at 94 mm intervals, the drum may have foreign material, such as glue from a label, stuck on the drum surface.
- Before starting the cleaning procedure, see *Related Information: Clean the Machine*.

1. Make sure the machine is in Ready Mode.
2. Press  [Settings] > [All Settings] > [Print Reports] > [Drum Dot Print].



If your machine displays the [All Settings] menu on the Home screen, skip the [Settings] menu.

3. Press [Yes].  
The machine prints the Drum Dot Check Sheet.
4. Press .
5. Press and hold  to turn the machine off.
6. Press the front cover release button and open the front cover.

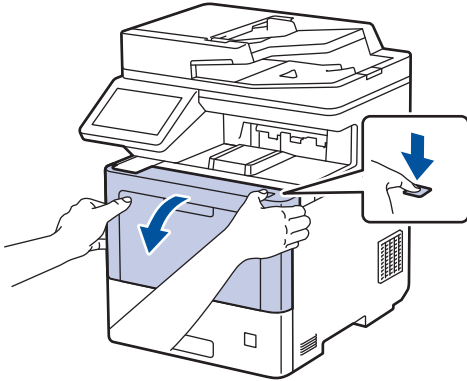

7. Hold the drum unit's green labeled handle. Pull the drum unit out of the machine until it stops.

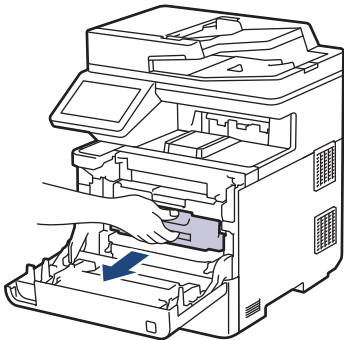

### CAUTION

We recommend placing the toner cartridge and drum unit assembly on a clean, flat surface with disposable paper underneath it in case you accidentally spill or scatter toner.



8. Holding the green labeled handles of the drum unit, lift the front of the drum unit and remove it from the machine.

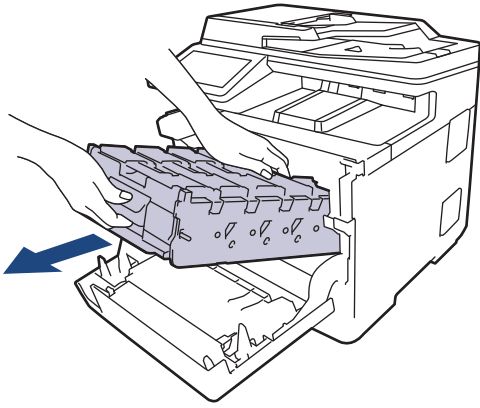

## IMPORTANT

Hold the handles of the drum unit when you carry it. DO NOT hold the sides of the drum unit.

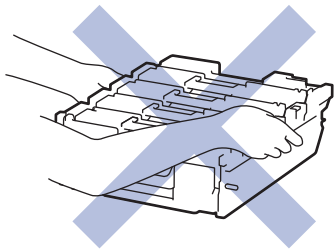

9. Hold the handle of the toner cartridge and pull the toner cartridge up and out of the drum unit. Repeat this for all toner cartridges.

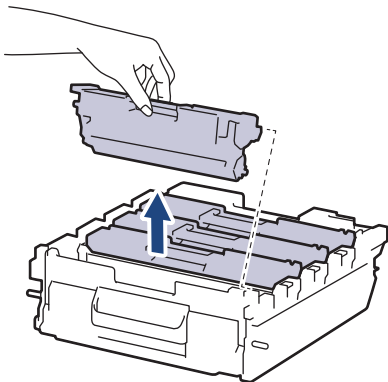

10. Turn the drum unit over by holding the green labeled handles. Make sure that the drum unit gears (1) are on the right side.

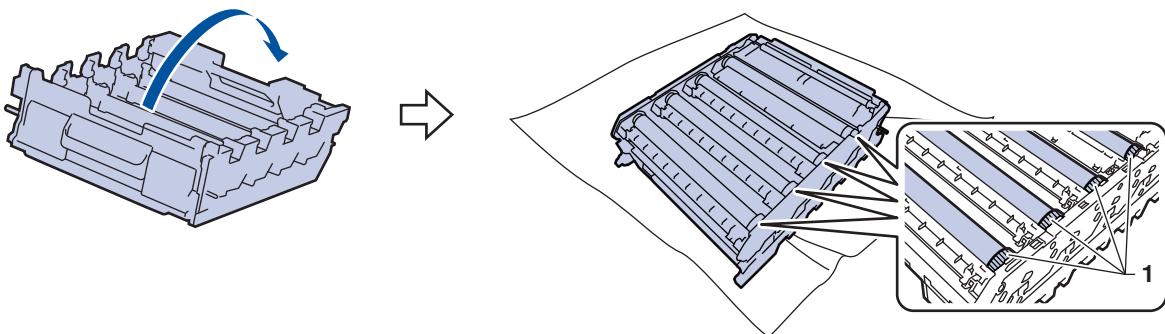

11. Use the column numbers next to the drum roller to find the mark. For example, a cyan dot in column 2 on the check sheet would mean that there is a mark in the "2" region of the cyan drum.

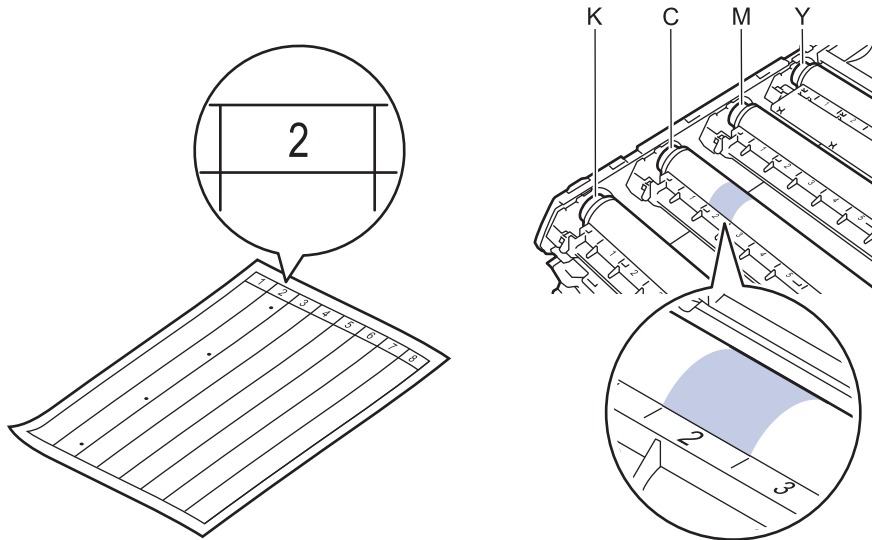

- K: Black
- C: Cyan
- M: Magenta
- Y: Yellow

12. Hold the drum unit frame with both hands, place your thumb on the drum unit gear, and roll the drum towards you by hand while looking at the surface of the suspected area.

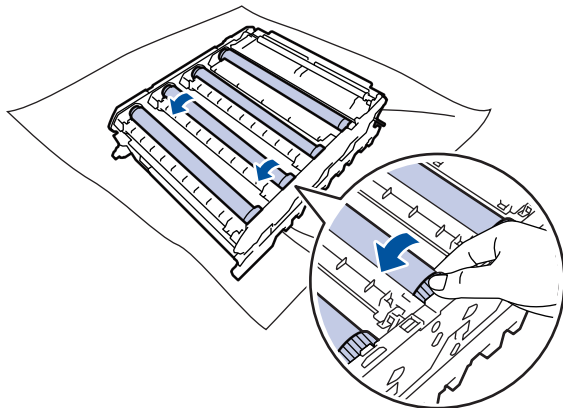

To avoid print quality problems, DO NOT touch any surface of the drum rollers except the drum unit gear.

13. Wipe the surface of the drum gently with a dry cotton swab until the mark on the surface comes off.

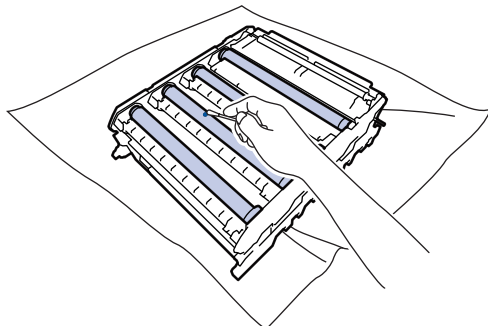

## NOTE

DO NOT clean the surface of the photosensitive drum with a sharp object or any liquids.

14. Turn the drum unit over by holding the green labeled handles.

15. Reinsert the toner cartridge into the new drum unit. Make sure that you match the toner cartridge colour to the same colour label on the drum unit. Repeat this for all toner cartridges.

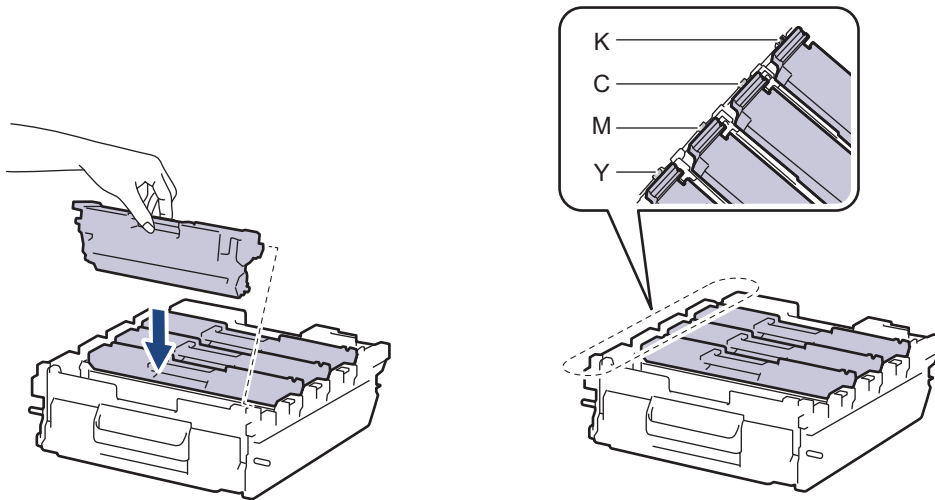

- K: Black
- C: Cyan
- M: Magenta
- Y: Yellow



Make sure you put the toner cartridge in correctly or it may separate from the drum unit.

16. Gently slide the drum unit into the machine until it stops.

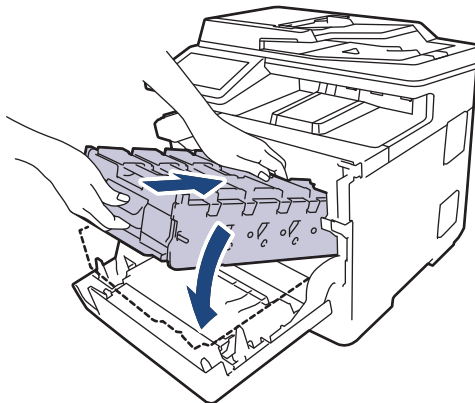

17. Using the green labeled handle, push the drum unit back into the machine until it locks in place.

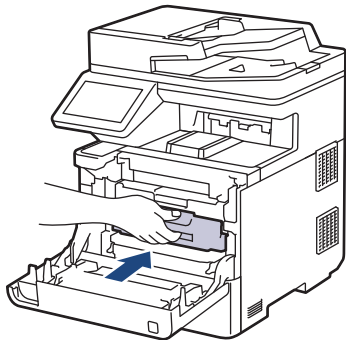

18. Close the machine's front cover.

19. Press  to turn the machine on.



## Related Information

- [Clean the Machine](#)

---

**Related Topics:**

- [Improve the Print Quality](#)
-

## Clean the Paper Pick-up Rollers

Cleaning the paper pick-up rollers periodically may prevent paper jams by ensuring that paper feeds correctly.

Before starting the cleaning procedure, see *Related Information: Clean the Machine*.

If you have paper feed problems, clean the pick-up rollers as follows:

1. Press and hold  to turn the machine off.
2. Pull the paper tray completely out of the machine.

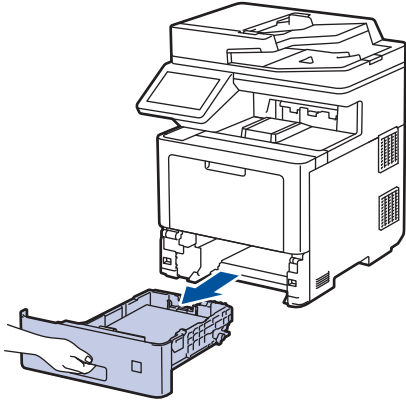

3. If paper is loaded or something is stuck inside in the paper tray, remove it.
4. Tightly wring out a lint-free cloth soaked in lukewarm water, and then wipe the separator pad on the paper tray to remove dust.

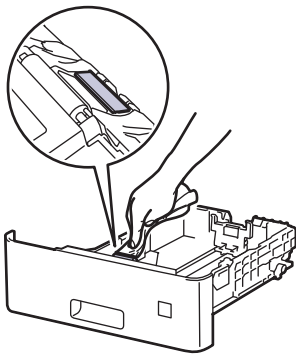

5. Wipe the two pick-up rollers inside the machine to remove dust.

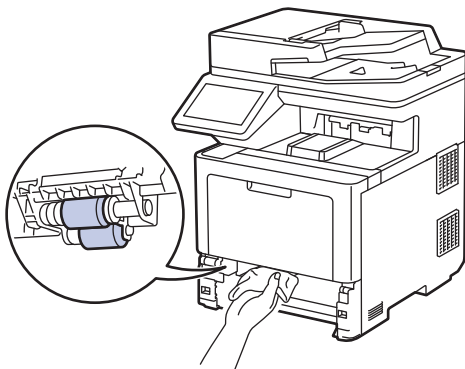

6. Reload the paper and put the paper tray firmly back in the machine.
7. Press  to turn the machine on.

### Related Information

- [Clean the Machine](#)

---

**Related Topics:**

- [Printing Problems](#)
-

## Correct Colour Printing

If the colour print quality is poor, calibrate the output density of each colour, and then perform the colour alignment.



To perform the calibrations of each colour's output density and colour alignment in sequence, set the Auto Correction function to On.

1. Press  [Settings] > [All Settings] > [Printer] > [Colour Correction] > [Correction Start].



If your machine displays the [All Settings] menu on the Home screen, skip the [Settings] menu.

2. Press [Yes].



The Colour correction starts automatically, and will take a few minutes.

3. Press .



### Related Information

- [Routine Maintenance](#)
  - [Set the Auto Correction Function](#)
  - [Reset the Machine's Colour Correction Settings](#)

#### Related Topics:

- [Improve the Print Quality](#)

## Set the Auto Correction Function

If you want your machine to automatically perform colour alignment after calibrating colours, turn on the Auto Correction function.

1. Press  [Settings] > [All Settings] > [Printer] > [Colour Correction] > [Auto Correction] > [On].



If your machine displays the [All Settings] menu on the Home screen, skip the [Settings] menu.

2. Press .



### Related Information

- [Correct Colour Printing](#)



## Reset the Machine's Colour Correction Settings

If the output colour differs from what you see on your screen, try resetting your machine's colour correction settings.

1. Press  [Settings] > [All Settings] > [Printer] > [Colour Correction] > [Reset].



If your machine displays the [All Settings] menu on the Home screen, skip the [Settings] menu.

2. Press [Yes].
3. Press .



### Related Information

- [Correct Colour Printing](#)

## Check the Remaining Part Life

1. Press  [Settings] > [All Settings] > [Machine Info.] > [Parts Life].



If your machine displays the [All Settings] menu on the Home screen, skip the [Settings] menu.

2. Press the machine part you want to check.  
The LCD displays the approximate remaining part life.

3. Press .



To display the approximate remaining life of the toner cartridge, press  on the LCD.



### Related Information

- [Routine Maintenance](#)

## Pack and Ship Your Machine

### WARNING

- This product is heavy and weighs more than 36.2 kg. To prevent possible injuries, at least two people should lift the product by holding it at the front and back.
- When you move the machine, carry the machine as shown in the illustration.

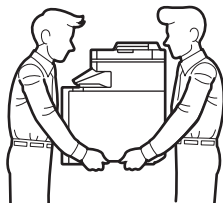

- If the machine has Optional Tray(s) installed, remove the Optional Tray(s) BEFORE moving the machine. Attempting to move the machine without removing the Optional Tray(s) may cause injury to you or damage to the machine.
- Pack the Optional Tray(s) separately in the original carton with original packing material.



- If for any reason you must ship your machine, carefully repack the machine in the original packaging to avoid any damage during transit. The machine should be adequately insured with the carrier.
- The components included in the box may differ depending on your country.

1. Press and hold  to turn the machine off. Leave the machine off for at least 10 minutes to cool down.
2. Disconnect all the cables, and then unplug the power cord from the electrical socket.
3. Put the machine into the bag it originally came in.
4. Pack the machine, the printed materials, and the AC power cord (if applicable) in the original carton with the original packing material as shown. (The original packing material may differ depending on your country.)

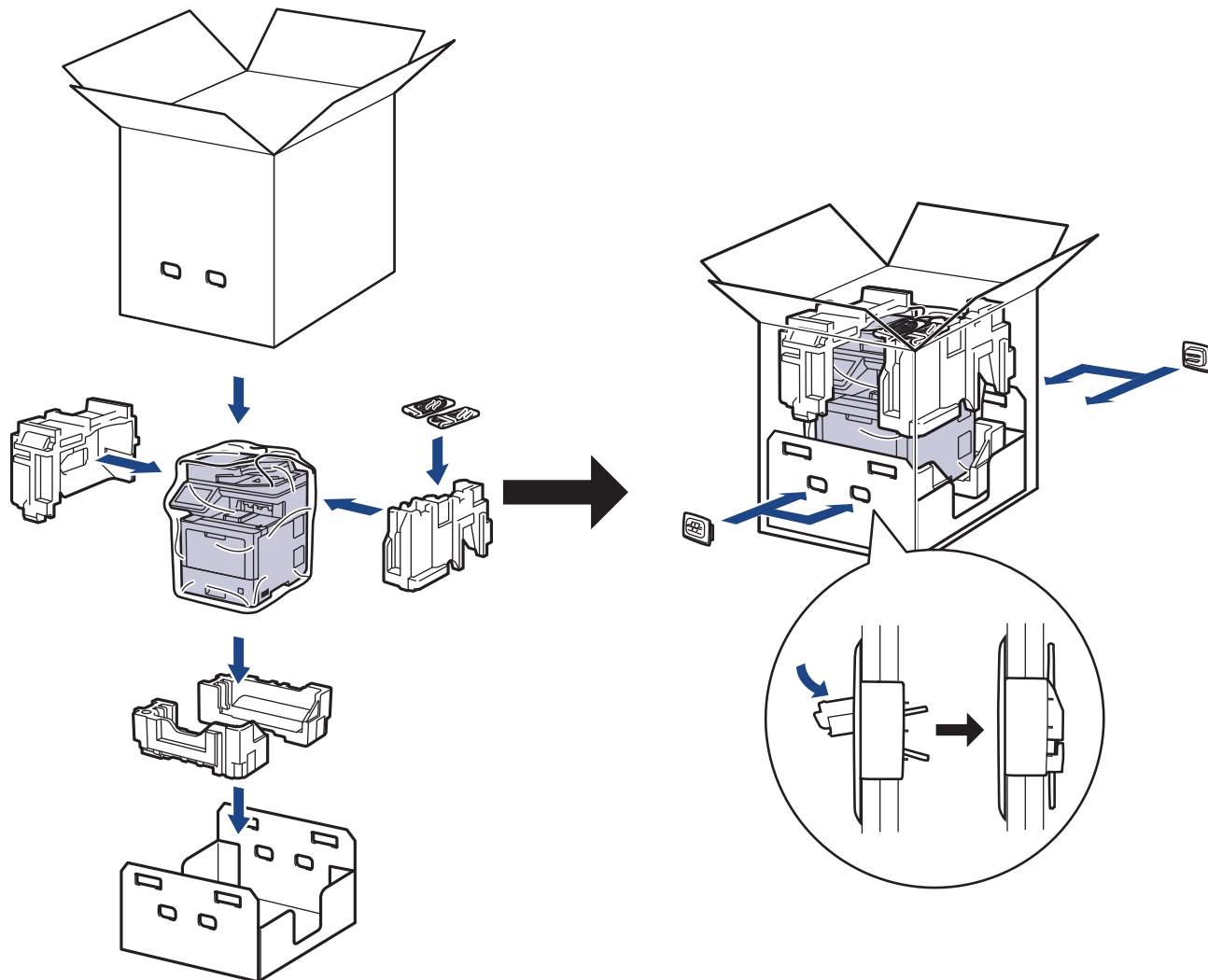

5. Close the carton and tape it shut.
6. If you have a Lower Tray, repack it as shown.

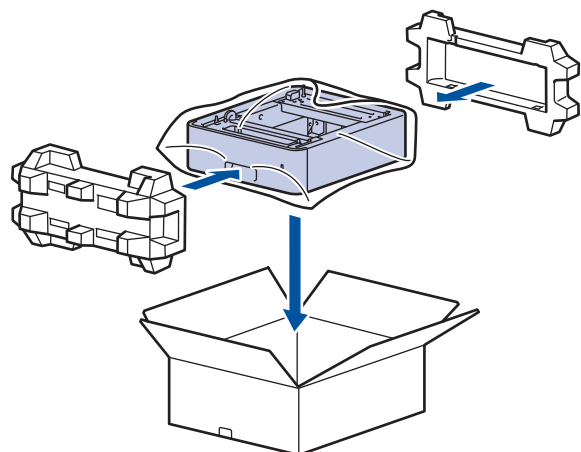

## ✓ Related Information

- [Routine Maintenance](#)

## Replace Periodic Maintenance Parts

Replace the following parts regularly to maintain print quality. The parts listed below must be replaced after printing approximately 50,000 pages<sup>1</sup> for the Paper Feeding Kits of the MP tray, approximately 100,000 pages<sup>1</sup> for the Paper Feeding Kits of the optional paper tray, and approximately 200,000 pages<sup>1</sup> for the Paper Feeding Kits of the standard paper tray, Fuser Unit, and Laser Unit.

Contact Brother customer service or your local Brother dealer when the following message appears on the LCD:

| LCD Message                                    | Description  |
|--|--|
| Maintenance<br>Replace Fuser <sup>2</sup>      | Replace the Fuser Unit.  |
| Maintenance<br>Replace Laser <sup>2</sup>      | Replace the Laser Unit.  |
| Maintenance<br>Replace PF Kit 1 <sup>23</sup>  | Replace the Paper Feeding Kit for the Standard Paper Tray.     |
| Maintenance<br>Replace PF Kit 2 <sup>234</sup> | Replace the Paper Feeding Kit for the Optional Tray.           |
| Maintenance<br>Replace PF Kit MP <sup>23</sup> | Replace the Paper Feeding Kit for the Multi-purpose (MP) Tray. |



### Related Information

- [Routine Maintenance](#)

<sup>1</sup> Letter or A4 size 1-sided pages.

<sup>2</sup> The replacement frequency depends on the complexity of printed pages, percentage of coverage, and the type of media used.

<sup>3</sup> The kit includes the roller holder assembly, separation pad, and separation pad spring for the paper tray or MP Tray.

<sup>4</sup> If you use the Optional Tray(s) with your machine, this message will appear on the LCD. When the machine has multiple Optional Trays, the machine displays messages using numbers corresponding to each Optional Tray.

## Machine Settings

Customise settings and features to make your machine a more efficient work tool.

- [Change Machine Settings from the Control Panel](#)
- [Change Machine Settings from Your Computer](#)

## Change Machine Settings from the Control Panel

- [In the Event of Power Failure \(Memory Storage\)](#)
- [General Settings](#)
- [Save Your Favourite Settings as a Shortcut](#)
- [Print Reports](#)
- [Settings and Features Tables](#)

## In the Event of Power Failure (Memory Storage)

Your menu settings are stored permanently, and in the event of a power failure will not be lost. Temporary settings (for example, Contrast, Overseas Mode) are lost.

During a power failure, the machine will retain the date and time and programmed fax timer jobs (for example, Delayed Fax) for approximately 60 hours. Other fax jobs in the machine's memory will not be lost.



### Related Information

- [Change Machine Settings from the Control Panel](#)
-



## General Settings

- [Adjust the Machine's Volume](#)
- [Change for Daylight Saving Time Automatically](#)
- [Set Sleep Mode Countdown](#)
- [About Deep Sleep Mode](#)
- [Set Auto Power Off Mode](#)
- [Set the Date and Time](#)
- [Set the Time Zone](#)
- [Adjust the LCD Backlight Brightness](#)
- [Change How Long the LCD Backlight Stays On](#)
- [Set Your Station ID](#)
- [Set Tone or Pulse Dialling Mode](#)
- [Reduce Toner Consumption](#)
- [Prevent Dialling a Wrong Number \(Dial Restriction\)](#)
- [Reduce Printing Noise](#)
- [Change the Language on the LCD](#)

## Adjust the Machine's Volume

1. Press  [Settings] > [All Settings] > [General Setup] > [Volume].



If your machine displays the [All Settings] menu on the Home screen, skip the [Settings] menu.

2. Press one of the following options :  
(The options will vary depending on your machine.)
  - [Ring]  
Adjust the ring volume.
  - [Beep]  
Adjust the volume of the beep you hear when you press a button, make a mistake, or after you send or receive a fax.
  - [Speaker]  
Adjust the speaker volume.
3. Select the [Off], [Low], [Med] or [High] option, and then press the option you want.
4. Press .



### Related Information

- [General Settings](#)

## Change for Daylight Saving Time Automatically

You can program the machine to change automatically for Daylight Saving Time.

It will reset itself forward one hour in the spring, and back one hour in the autumn. Make sure you have set the correct date and time in the Date & Time setting.

This feature is available only in some countries.

1. Press  [Settings] > [All Settings] > [Initial Setup] > [Date & Time] > [Auto Daylight].



If your machine displays the [All Settings] menu on the Home screen, skip the [Settings] menu.

2. Press [On] or [Off].
3. Press .



### Related Information

- [General Settings](#)

## Set Sleep Mode Countdown

The Sleep Mode (or Power Save Mode) setting can reduce power consumption. When the machine is in Sleep Mode, it acts as though it is turned off. The machine will wake up and start printing when it receives a print job or a fax. Use these instructions to set a time delay (countdown) before the machine enters Sleep Mode.

- You can choose how long the machine must be idle before it goes into Sleep Mode.
- The timer will restart if any operation is carried out on the machine, such as receiving a print job.

1. Press  [Settings] > [All Settings] > [General Setup] > [Ecology] > [Sleep Time].



If your machine displays the [All Settings] menu on the Home screen, skip the [Settings] menu.

2. Enter the length of time (maximum 50 minutes) the machine will remain idle before entering Sleep Mode, and then press [OK].

3. Press .



### Related Information

- [General Settings](#)



## About Deep Sleep Mode

If the machine is in Sleep Mode and does not receive any jobs for certain length of time, the machine will automatically enter Deep Sleep Mode. The length of time is based on your specific model and settings.

Deep Sleep Mode uses less power than Sleep Mode.



The Deep Sleep Mode setting cannot be disabled due to environmental considerations.

| Applicable Models  | Machine's Control Panel in Deep Sleep Mode                        | Conditions That Will Wake the Machine  |
|--|---|--|
| MFC-L9630CDN/<br>MFC-L9635CDN/<br>MFC-L9670CDN/MFC-EX670 | The LCD backlight turns off and the Power LED brightens and dims. | <ul style="list-style-type: none"><li>The machine receives a job.</li><li>Someone presses ,  or the touchscreen LCD.</li></ul> |





### Related Information

- [General Settings](#)

## Set Auto Power Off Mode

If the machine is in Deep Sleep Mode for certain length of time, based on your model and settings, the machine will go into Power Off Mode automatically. The machine does not go into Power Off Mode when the machine is connected to a network or a telephone line, or has secure print data in the memory (available only for certain models).

To start printing, press  on the control panel and then send a print job.

1. Press  [Settings] > [All Settings] > [General Setup] > [Ecology] > [Auto Power Off].



If your machine displays the [All Settings] menu on the Home screen, skip the [Settings] menu.

2. Press the [Off], [1 hour], [2 hours], [4 hours] or [8 hours] option you want.
3. Press .



### Related Information



- [General Settings](#)

## Set the Date and Time

1. Press  [Settings] > [All Settings] > [Initial Setup] > [Date & Time] > [Date].



If your machine displays the [All Settings] menu on the Home screen, skip the [Settings] menu.

2. Enter the last two digits of the year using the LCD, and then press [OK].
3. Enter the two digits for the month using the LCD, and then press [OK].
4. Enter the two digits for the day using the LCD, and then press [OK].
5. Press [Clock Type].
6. Press [12h Clock] or [24h Clock].
7. Press [Time].
8. To enter the time, do one of the following:
  - If you selected [12h Clock] as the format in the [Clock Type] setting, enter the time (in 12-hour format) using the LCD.  
Press   to select [AM] or [PM].  
Press [OK].
  - If you selected [24h Clock] as the format in the [Clock Type] setting, enter the time (in 24-hour format) using the LCD.  
Press [OK].  
(For example: enter 19:45 for 7:45 PM.)
9. Press .



### Related Information

- [General Settings](#)

## Set the Time Zone

Set the time zone for your location on the machine.

1. Press  [Settings] > [All Settings] > [Initial Setup] > [Date & Time] > [Time Zone].



If your machine displays the [All Settings] menu on the Home screen, skip the [Settings] menu.

2. Enter your time zone.
3. Press [OK].
4. Press .



### Related Information

- [General Settings](#)



## Adjust the LCD Backlight Brightness

If you are having difficulty reading the LCD, changing the brightness setting may help.

1. Press  [Settings] > [All Settings] > [General Setup] > [LCD Settings] > [Backlight].



If your machine displays the [All Settings] menu on the Home screen, skip the [Settings] menu.

2. Press the [Light], [Med] or [Dark] option.
3. Press .



### Related Information

- [General Settings](#)

## Change How Long the LCD Backlight Stays On

Set how long the LCD backlight stays on.

1. Press  [Settings] > [All Settings] > [General Setup] > [LCD Settings] > [Dim Timer].



If your machine displays the [All Settings] menu on the Home screen, skip the [Settings] menu.

2. Press the option you want:

- [10 Secs]
- [20 Secs]
- [30 Secs]

3. Press .



### Related Information

- [General Settings](#)

## Set Your Station ID

Set the machine to print your Station ID and the fax's date and time at the top of each fax you send.

1. Press  [Settings] > [All Settings] > [Initial Setup] > [Station ID] > [Fax].



If your machine displays the [All Settings] menu on the Home screen, skip the [Settings] menu.

2. Enter your fax number (up to 20 digits) using the LCD, and then press [OK].
3. Press [Tel].
4. Enter your telephone number (up to 20 digits) using the LCD, and then press [OK].
5. Press [Name].
6. Enter your name (up to 20 characters) using the LCD, and then press [OK].



- Press  to cycle between letters, numbers and special characters. (The characters available may differ depending on your country.)

If your machine displays  , press  .

- If you enter an incorrect character, press ◀ or ▶ to move the cursor to it and press . Press the correct character.
- To enter a space, press [Space] or ▶.
- For more detailed information, see *Related Information*.

7. Press .



### Related Information

- [General Settings](#)

#### Related Topics:

- [How to Enter Text on Your Machine](#)
- [Transfer Faxes to Another Fax Machine](#)
- [Transfer the Fax Journal Report to Another Fax Machine](#)

## Set Tone or Pulse Dialling Mode

Your machine is set for a Tone dialling service. If you have a Pulse dialling (rotary) service, you must change the dialling mode.

This feature is not available in some countries.

1. Press  [Settings] > [All Settings] > [Initial Setup] > [Tone/Pulse].



If your machine displays the [All Settings] menu on the Home screen, skip the [Settings] menu.

2. Press [Tone] or [Pulse].
3. Press .



### Related Information

- [General Settings](#)

## Reduce Toner Consumption

Using the Toner Save feature may reduce toner consumption. When Toner Save is set to on, the print on your documents appears lighter.

We DO NOT recommend using the Toner Save feature for printing photo or greyscale images.

1. Press  [Settings] > [All Settings] > [General Setup] > [Ecology] > [Toner Save].



If your machine displays the [All Settings] menu on the Home screen, skip the [Settings] menu.

2. Press [On] or [Off].
3. Press .



### Related Information

- [General Settings](#)

#### Related Topics:

- [Improve the Print Quality](#)

## Prevent Dialling a Wrong Number (Dial Restriction)

This feature prevents users from sending a fax or call to the wrong number by mistake. You can set the machine to restrict dialling when you use the dial pad, Address Book, Shortcuts and LDAP search.

1. Press  [Settings] > [All Settings] > [Fax] > [Dial Restriction].



If your machine displays the [All Settings] menu on the Home screen, skip the [Settings] menu.

2. Press one of the following options:

- [Dial Pad]
- [Address Book]



If you combine Address Book numbers when dialling, the numbers will be recognised as dial pad input and will not be restricted.

- [Shortcuts]
- [LDAP Server]

3. Press one of the following options:

| Option        | Description   |
|---------------|---|
| Enter # Twice | The machine prompts you to re-enter the number, and then if you re-enter the same number correctly, the machine will start dialling. If you re-enter the wrong number, the LCD will display an error message. |
| On            | The machine restricts all fax sending and outbound calls for that dialling method.  |
| Off           | The machine does not restrict the dialling method.  |



- The [Enter # Twice] setting will not work if you use an external phone before entering the number. You will not be asked to re-enter the number.
- If you choose [On] or [Enter # Twice], you cannot use the Broadcasting feature.

4. Press .



### Related Information

- [General Settings](#)

## Reduce Printing Noise

The Quiet Mode setting can reduce printing noise. When Quiet Mode is turned on, the print speed becomes slower. The factory setting is off.

1. Press  [Settings] > [All Settings] > [General Setup] > [Ecology] > [Quiet Mode].



If your machine displays the [All Settings] menu on the Home screen, skip the [Settings] menu.

2. Press [On] or [Off].
3. Press .



### Related Information

- [General Settings](#)

## Change the Language on the LCD

Change the LCD language if needed.

This feature is not available in some countries.

1. Press  [Settings] > [All Settings] > [Initial Setup] > [Local Language].



If your machine displays the [All Settings] menu on the Home screen, skip the [Settings] menu.

2. Press your language.
3. Press .



### Related Information

- [General Settings](#)



## Save Your Favourite Settings as a Shortcut

- [Add Shortcuts](#)
- [Change or Delete Shortcuts](#)
- [Assign a Shortcut to an ID Card](#)

## Add Shortcuts

You can add the Fax, Copy, Scan, Web Connect and Apps settings you use most frequently by saving them as your Shortcuts. Later you can press the Shortcut to apply these settings instead of manually re-entering them.



Some Shortcut menus are not available depending on your model.

These instructions describe how to add a Copy Shortcut. The steps for adding a Fax, Scan, Web Connect, or Apps Shortcut are very similar.

1. Press **+** [Shortcuts]. (If **+** [Shortcuts] is displayed.)
2. Press a tab.



Swipe to display the tab if needed.

3. Press **+** where you have not added a Shortcut.
4. Press [Copy].
5. Press > to access the preset copy settings.
6. Swipe up or down or press ▲ or ▼ to display the copy presets, and then press the copy preset you want.
7. Press [Options].
8. Swipe up or down or press ▲ or ▼ to display the available settings, and then press the setting you want to change.
9. Swipe up or down or press ▲ or ▼ to display the available options for the setting, and then press the option you want.  
Repeat these two steps until you have selected all the settings and options you want.
10. When you have finished changing settings, press [OK]. (If the [OK] button is displayed.)
11. Press [Save as Shortcut].
12. Read and confirm the displayed list of settings you have selected, and then press [OK].
13. Enter a name for the Shortcut using the LCD, and then press [OK].



### Related Information

- [Save Your Favourite Settings as a Shortcut](#)

## Change or Delete Shortcuts



You cannot change a Web Connect Shortcut or Apps Shortcut. If you need to change them, delete them, and then add a new Shortcut.

1. Press **+** [Shortcuts]. (If **+** [Shortcuts] is displayed.)
2. Press a tab to display the Shortcut you want to change.



Swipe to display the tab if needed.

3. Press the Shortcut you want to change.  
The settings for the Shortcut you selected appear.



To delete the Shortcut or edit the name, press and hold the Shortcut until the options appear, and then follow the on-screen menus.

4. Press [Options].
5. Change the settings for the Shortcut if needed.
6. Press [OK] (if needed).
7. When finished, press [Save as Shortcut].
8. Read and confirm the displayed list of settings you have selected, and then press [OK].
9. Do one of the following:
  - To overwrite the Shortcut, press [Yes].
  - If you do not want to overwrite the Shortcut, press [No] to enter a new Shortcut name.  
Press **+** where you have not added a Shortcut.  
Enter a new name using the LCD, and then press [OK].



To edit the name, hold down  to delete the current name.



### Related Information

- [Save Your Favourite Settings as a Shortcut](#)

## Assign a Shortcut to an ID Card

You can assign one machine Shortcut to your ID card. When you touch your ID card to the machine's NFC symbol, your personal Shortcut will automatically appear on the touchscreen.



- You cannot use the same ID card for different Shortcuts.
- To use the ID card for another Shortcut, unregister the card first, and then register it with the new Shortcut.

1. Press the tab that contains the Shortcut you want to assign to your ID card.
2. Press and hold the Shortcut until the options appear.
3. Press `[Register Card/NFC]`.
4. Touch the ID card to the NFC symbol.
5. Press `[Register]`.

The Shortcut is assigned to the ID Card.



### Related Information

- [Save Your Favourite Settings as a Shortcut](#)

## Print Reports

- [Reports](#)
- [Print a Report](#)

## Reports

The following reports are available:

### **XMIT Verify**

The XMIT Verify report prints a Transmission Verification Report of your last transmission.

### **Address Book**

The Address Book report prints a list of names and numbers stored in the Address Book memory.

### **Fax Journal**

The Fax Journal prints a list of information about your last 200 incoming and outgoing faxes. (TX means Transmit, RX means Receive.)

### **User Settings**

The User Settings report prints a list of your current settings.

### **Printer Settings**

The Printer Settings report prints a list of your current printer settings.

### **Network Configuration (Models with network functionality)**

The Network Configuration report prints a list of your current network settings.

### **Print File List**

The Print File List prints a list of the fonts and print the macro/stream setting stored in the machine.

### **Drum Dot Print**

The Drum Dot Print prints the drum dot sheet, which helps when it is time to clean the drum unit.

### **WLAN Report (Models with wireless network functionality)**

The WLAN Report prints the wireless LAN connectivity diagnosis.



## **Related Information**

- [Print Reports](#)

## Print a Report

1. Press  [Settings] > [All Settings] > [Print Reports].



If your machine displays the [All Settings] menu on the Home screen, skip the [Settings] menu.

2. Swipe up or down or press ▲ or ▼ to display the report you want to print, and then press it.
3. Do one of the following:
  - If you choose [XMIT Verify], do one of the following:
    - To view the Transmission Verification Report, press [View on LCD].
    - To print the Transmission Verification Report, press [Print Report].
  - If you choose other reports, go to next step.
4. Press [Yes].
5. Press .



### Related Information

- [Print Reports](#)

## Settings and Features Tables

The Settings tables will help you understand the menu selections and options that are found in the machine's programs.

- [Settings Tables](#)
- [Feature Tables](#)



## Settings Tables

- >> [General Setup]
- >> [Shortcut Settings]
- >> [Fax]
- >> [Printer]
- >> [Network]
- >> [Print Reports]
- >> [Machine Info.]
- >> [Initial Setup]
- >> [Admin Settings]

### [General Setup]

#### [All Settings] > [General Setup]

| Level 3      | Level 4         | Level 5             | Level 6  | Descriptions  |  |
|--------------|-----------------|---------------------|----------|---|--|
| Tray Setting | Paper Type      | MP Tray             | -        | Select the paper type that matches the paper in the MP tray.                |  |
|              |                 | Tray 1              | -        | Select the paper type that matches the paper in the standard paper tray.    |  |
|              |                 | Tray 2 <sup>1</sup> | -        | Select the paper type that matches the paper in the Optional Tray (Tray 2). |  |
|              |                 | Tray 3 <sup>1</sup> | -        | Select the paper type that matches the paper in the Optional Tray (Tray 3). |  |
|              |                 | Tray 4 <sup>1</sup> | -        | Select the paper type that matches the paper in the Optional Tray (Tray 4). |  |
|              |                 | Tray 5 <sup>2</sup> | -        | Select the paper type that matches the paper in the Optional Tray (Tray 5). |  |
|              | Paper Size      | MP Tray             | -        | Select the size of paper you loaded in the MP tray.                         |  |
|              |                 | Tray 1              | -        | Select the size of paper you loaded in the standard paper tray.             |  |
|              |                 | Tray 2 <sup>1</sup> | -        | Select the size of paper you loaded in the Optional Tray (Tray 2).          |  |
|              |                 | Tray 3 <sup>1</sup> | -        | Select the size of paper you loaded in the Optional Tray (Tray 3).          |  |
|              |                 | Tray 4 <sup>1</sup> | -        | Select the size of paper you loaded in the Optional Tray (Tray 4).          |  |
|              |                 | Tray 5 <sup>2</sup> | -        | Select the size of paper you loaded in the Optional Tray (Tray 5).          |  |
|              | Tray Use: Copy  | -                   | -        | Select the tray to be used for Copy.  |  |
|              | Tray Use: Fax   | -                   | -        | Select the tray to be used for Fax.   |  |
|              | Tray Use: Print | -                   | -        | Select the tray to be used for Print.                                       |  |
|              | Print Position  | MP Tray             | X Offset |   | Move the print start position (at the top-left corner of pages) of paper you loaded in the MP tray horizontally up to -500 (left) to +500 (right) dots in 300 dpi. |
|              |                 |                     | Y Offset |   | Move the print start position (at the top-left corner of pages) of paper you loaded in the MP tray vertically up to -500 (up) to +500 (down) dots in 300 dpi.      |

| Level 3      | Level 4        | Level 5                     | Level 6   | Descriptions  |  |
|--------------|----------------|-----------------------------|---|---|--|
| Tray Setting | Print Position | Tray 1                      | X Offset  | Move the print start position (at the top-left corner of pages) of paper you loaded in the standard paper tray horizontally up to -500 (left) to +500 (right) dots in 300 dpi.    |  |
|              |                |                             | Y Offset  | Move the print start position (at the top-left corner of pages) of paper you loaded in the standard paper tray vertically up to -500 (up) to +500 (down) dots in 300 dpi.         |  |
|              |                | Tray 2 <sup>1</sup>         | X Offset  | Move the print start position (at the top-left corner of pages) of paper you loaded in the Optional Tray (Tray 2) horizontally up to -500 (left) to +500 (right) dots in 300 dpi. |  |
|              |                |                             | Y Offset  | Move the print start position (at the top-left corner of pages) of paper you loaded in the Optional Tray (Tray 2) vertically up to -500 (up) to +500 (down) dots in 300 dpi.      |  |
|              |                | Tray 3 <sup>1</sup>         | X Offset  | Move the print start position (at the top-left corner of pages) of paper you loaded in the Optional Tray (Tray 3) horizontally up to -500 (left) to +500 (right) dots in 300 dpi. |  |
|              |                |                             | Y Offset  | Move the print start position (at the top-left corner of pages) of paper you loaded in the Optional Tray (Tray 3) vertically up to -500 (up) to +500 (down) dots in 300 dpi.      |  |
|              |                | Tray 4 <sup>1</sup>         | X Offset  | Move the print start position (at the top-left corner of pages) of paper you loaded in the Optional Tray (Tray 4) horizontally up to -500 (left) to +500 (right) dots in 300 dpi. |  |
|              |                |                             | Y Offset  | Move the print start position (at the top-left corner of pages) of paper you loaded in the Optional Tray (Tray 4) vertically up to -500 (up) to +500 (down) dots in 300 dpi.      |  |
|              |                | Tray 5 <sup>2</sup>         | X Offset  | Move the print start position (at the top-left corner of pages) of paper you loaded in the Optional Tray (Tray 5) horizontally up to -500 (left) to +500 (right) dots in 300 dpi. |  |
|              |                |                             | Y Offset  | Move the print start position (at the top-left corner of pages) of paper you loaded in the Optional Tray (Tray 5) vertically up to -500 (up) to +500 (down) dots in 300 dpi.      |  |
|              |                | Skip Tray <sup>3</sup>      | -   | -   | Select a specific tray you do not want to use if it is loaded with paper of the wrong size.                    |
|              |                | Separator Tray <sup>3</sup> | -   | -   | Select the tray that contains the paper used as the separator paper, which is inserted between each print job. |
|              |                | Paper Low Notice            | Paper Low Notice  | -   | Select whether to display a notification that the paper tray is nearly empty.                                  |
|              |                |                             |   | Notice Level  | Select the minimum paper level that will trigger the message.  |
| Check Paper  | -              | -                           | Select whether to display a message telling you to check the paper type and paper size. |   |  |
| Volume       | Ring           | -                           | -   | Adjust the ring volume.   |  |
|              | Beep           | -                           | -   | Adjust the beeper volume.   |  |
|              | Speaker        | -                           | -   | Adjust the speaker volume.  |  |

| Level 3         | Level 4  | Level 5 | Level 6 | Descriptions  |
|-----------------|--|---------|---------|---|
| LCD Settings    | Backlight  | -       | -       | Adjust the brightness of the LCD backlight.   |
|                 | Dim Timer  | -       | -       | Set how long the LCD backlight stays on after you go back to your Main Home screen and other functions.   |
| Notice Settings | Document Alert   | -       | -       | Select whether to alert you when the document is left on the scanner glass.   |
|                 | Scan Result(Skip Blank Page)   | -       | -       | Displays the total scanned pages and skipped blank pages after scanning is completed.   |
| Ecology         | Eco Mode   | -       | -       | Turn the following machine settings on at the same time. <ul style="list-style-type: none"> <li>• 2-sided Print:Long Edge<sup>4</sup></li> <li>• Sleep Time:0 Min</li> <li>• Dim Timer:10 Secs</li> <li>• Quiet Mode:On<sup>4</sup></li> <li>• Toner Save:On<sup>4</sup></li> </ul> |
|                 | Toner Save   | -       | -       | Increase the page yield of the toner cartridge.   |
|                 | Sleep Time   | -       | -       | Set how much time will pass before the machine enters Power Saving mode.  |
|                 | Quiet Mode   | -       | -       | Decrease printing noise.  |
|                 | Auto Power Off   | -       | -       | Set the number of hours that the machine will remain in Deep Sleep mode before going into Power Off mode.   |
| Delete Storage  | Macro ID   | -       | -       | Delete the registered Macro data.   |
|                 | Stream ID  | -       | -       | Delete the registered Stream data.  |
|                 | Font ID  | -       | -       | Delete the registered Font data.  |
|                 | Delete All   | -       | -       | Restore the Macro, Stream and Font data of your machine to the default settings.  |
|                 | Initialise USB Flash Drive<br>(Available only when the USB flash drive is selected in the Job Save Location menu.) | -       | -       | Initialise the USB flash drive for USB Storage Print. Initialising the USB flash drive takes more than 40 minutes.  |

1 Available if the Optional Tray(s) is installed.

2 Available if the Optional Tray(s) is installed.

3 Available if the Lower Tray(s) is installed.

4 Changing this setting is possible after you change certain machine settings using Web Based Management.

## [Shortcut Settings]

[All Settings] > [Shortcut Settings]

| Level 3             | Level 4           | Descriptions                     |
|---------------------|-------------------|----------------------------------|
| (Select a Shortcut) | Rename            | Change the shortcut name.        |
|                     | Edit              | Change the shortcut settings.    |
|                     | Delete            | Delete the shortcut.             |
|                     | Register Card/NFC | Assign a Shortcut to an ID card. |

| Level 3             | Level 4         | Descriptions                       |
|---------------------|-----------------|------------------------------------|
| (Select a Shortcut) | Delete Card/NFC | Remove a Shortcut from an ID card. |

**[Fax]**

**[All Settings] > [Fax]**

| Level 3          | Level 4        | Level 5  | Descriptions   |  |
|------------------|----------------|--|--|--|
| Setup Receive    | Ring Delay     | -  | Set the number of rings before the machine answers in Fax or Fax/Tel mode.   |  |
|                  | Receive Mode   | -  | Select the Receive Mode that best suits your needs.  |  |
|                  | F/T Ring Time  | -  | Set the length of the pseudo/double-ring time in Fax/Tel mode.   |  |
|                  | Fax Preview    | -  | View received faxes on the LCD.  |  |
|                  | Fax Detect     | -  | Receive fax messages automatically when you answer a call and hear fax tones.  |  |
|                  | Remote Codes   | Remote Codes   | -  | Answer calls at an extension or external telephone and use codes to turn the Remote Codes on or off. You can personalise the codes.  |
|                  |                | Act.Code   |  |  |
|                  |                | Deact.Code   |  |  |
|                  | Auto Reduction | -  | Reduce the size of incoming faxes.   |  |
|                  | PC Fax Receive | On   | On   | Set the machine to send faxes to your computer.  |
|                  |                | Off  |  | You can turn on the Backup Print safety feature.   |
|                  | Memory Receive | Off  | Off  | -  |
|                  |                | Fax Forward  | -  | Set the machine to forward fax messages or to store incoming faxes in the memory (so you can retrieve them while you are away from your machine).<br>If you select Fax Forward, you can turn on the Backup Print safety feature. |
| Fax Storage      |                |  |  |  |
| Forward to Cloud |                | -  | Forward incoming faxes to the online service.  |  |
| Fax Rx Stamp     | -              | Print the received time and date on the top of incoming faxes. |  |  |
| 2-sided          | -              | Print incoming faxes on both sides of the paper.               |  |  |
| Setup Send       | Batch TX       | -  | Combine delayed faxes to the same fax number at the same time of day into one transmission.                                |  |
|                  | Coverpage Note | -  | Set up your own comments for the fax cover page.   |  |
|                  | Auto Redial    | -  | Set the machine to redial the last fax number after five minutes, if the fax did not go through because the line was busy. |  |
|                  | Destination    | -  | Set the machine to display the destination information on the LCD during fax dialling.                                     |  |
| Report Setting   | XMIT Report    | -  | Select the initial setup for the Transmission Verification Report.   |  |
|                  | Journal Period | Journal Period   | Set the interval for automatic printing of the Fax Journal.  |  |
|                  |                | Time   | If you select an option other than Off and Every 50 Faxes, you can set the time for the option.                            |  |
|                  |                | Day  | If you select Every 7 Days, you can set the day of the week.   |  |
| Print Document   | -              | -  | Print incoming faxes stored in the machine's memory.   |  |

| Level 3          | Level 4                     | Level 5 | Descriptions   |
|------------------|-----------------------------|---------|--|
| Remote Access    | -                           | -       | Set your own code for Remote Retrieval.  |
| Dial Restriction | Dial Pad                    | -       | Restrict the dialling when using the dial pad.                                   |
|                  | Address Book                | -       | Restrict the dialling when using the Address Book.                               |
|                  | Shortcuts                   | -       | Restrict the dialling when using a Shortcut.                                     |
|                  | LDAP Server                 | -       | Restrict the dialling of LDAP server numbers.                                    |
| Remaining Jobs   | -                           | -       | Check which scheduled jobs are in the machine's memory and cancel selected jobs. |
| Miscellaneous    | BT Call Sign<br>(U.K. only) | -       | Use with BT Call Sign.   |

## [Printer]

[All Settings] > [Printer]

| Level 3        | Level 4       | Level 5       | Descriptions   |
|----------------|---------------|---------------|--|
| Emulation      | -             | -             | Select the emulation mode.   |
| Quality        | -             | -             | Select the print quality.  |
| Print Options  | Font List     | HP LaserJet   | Print a list of the machine's internal fonts.  |
|                |               | BR-Script 3   |  |
|                | Test Print    | -             | Print a test page.   |
| 2-sided        | 2-sided Print | -             | Enable or disable 2-sided printing and choose long edge or short edge.   |
|                | Single Image  | -             | For a print job where the last page is a one-sided image, select the 1-sided Feed option to reduce printing time.<br>When you use letterhead or preprinted paper, you must select the 2-sided Feed option. If you select 1-sided Feed for letterhead or preprinted paper, the last page will be printed on the reverse side. |
| Auto Continue  | -             | -             | Select if you want the machine to clear paper size errors or media type errors automatically, and use paper from other trays.  |
| Output Colour  | -             | -             | Set the output colour.   |
| Paper Type     | -             | -             | Set the type of paper.   |
| Paper Size     | -             | -             | Set the size of paper.   |
| Copies         | -             | -             | Set the number of printed pages.   |
| Orientation    | -             | -             | Set pages to print in either portrait or landscape orientation.  |
| Print Position | -             | -             | Access the Print Position setting menus.   |
| Auto FF        | -             | -             | Allow the machine to print any remaining data automatically.   |
| HP LaserJet    | Font No.      | Font No.      | Set the font number.<br>This menu appears if a soft font is installed on your Brother machine.   |
|                |               | Soft Font No. | Set the soft font number.<br>This menu appears if a soft font is installed on your Brother machine.  |
|                | Font Pitch    | -             | Set the font pitch.  |

| Level 3      | Level 4                             | Level 5   | Descriptions   |
|--------------|-------------------------------------|---|--|
| HP LaserJet  |                                     |   | (Available for certain font numbers)   |
|              | Font Point                          | -   | Set the font size.<br>(Available for certain font numbers)   |
|              | Symbol Set                          | -   | Select the symbol or character set.  |
|              | Table Print                         | -   | Print the code table.  |
|              | Auto LF                             | -   | ON: CR -> CR+LF, OFF: CR -> CR   |
|              | Auto CR                             | -   | ON: LF -> LF+CR, FF -> FF+CR, or VT -> VT+CR<br>OFF: LF -> LF, FF -> FF, or VT -> VT   |
|              | Auto WRAP                           | -   | Choose whether a line feed and carriage return will happen when the machine reaches the right margin.  |
|              | Auto SKIP                           | -   | Choose whether a line feed and carriage return will happen when the carriage position reaches the bottom margin.   |
|              | Left Margin                         | -   | Set the left margin at column 0 to 70 columns at 1 cpi.  |
|              | Right Margin                        | -   | Set the right margin at column 10 to 80 columns at 1 cpi.  |
|              | Top Margin                          | -   | Set the top margin distance from the top edge of the paper.  |
|              | Bottom Margin                       | -   | Set the bottom margin distance from the bottom edge of the paper.  |
|              | Lines                               | -   | Set the number of lines on each page.  |
| Tray Command | -                                   | Select this setting if a tray mismatch appears when you use the HP drivers. |  |
| BR-Script 3  | Error Print                         | -   | Choose whether the machine prints the error information when errors occur.   |
|              | CAPT                                | -   | Use CAPT (Colour Advanced Printing Technology) for optimal print quality when printing a PS file created by a non-Brother PS driver.<br>Colours and photos appear clearer and more accurate. Print speed will be slower. |
| PDF          | Multiple Page                       | -   | Set the page layout when printing multiple pages.  |
|              | PDF Print Options                   | -   | Set the PDF Print setting to print either comments (Markup) or stamps in the PDF file, along with the text.  |
|              | PDF Fit to Page                     | -   | Select if the machine scales or resizes the pages in the PDF file to fit the selected paper size.  |
| Carbon Menu  | Carbon Copy                         | -   | Enable or disable the Carbon Copy function.  |
|              | Copies                              | -   | Sets the number of printed pages.  |
|              | Copy1 Tray                          | -   | Select the tray you use for Copy1.   |
|              | Copy1 Stream                        | -   | Select a stream for Copy1.   |
|              | Copy2 Tray<br>...<br>Copy8 Tray     | -   | Select the tray you use for Copy2 to 8.  |
|              | Copy2 Stream<br>...<br>Copy8 Stream | -   | Select a stream for Copy2 to 8.  |

| Level 3           | Level 4          | Level 5                  | Descriptions   |   |
|-------------------|------------------|--------------------------|--|---|
| Colour Correction | Correction Start | -                        | Perform colour calibration to check and correct colours, and then perform registration to align the print position of each colour. |   |
|                   | Reset            | -                        | Reset the calibration parameters to the default settings.  |   |
|                   | Auto Correction  | -                        | Set the machine to perform Colour Calibration and Registration automatically.  |   |
|                   | Colour Settings  | Setting Mode             |  | Select whether to apply the colour print settings of the machine or the printer driver. |
|                   |                  | Colour Mode              |  | Select the colour mode.   |
|                   |                  | Improve Grey Colour      |  | Turn on or off to improve the image quality of shaded areas.                            |
|                   |                  | Enhance Black Printing   |  | Turn on or off if a black graphic does not print correctly.                             |
|                   |                  | Brightness               |  | Adjust the brightness.  |
|                   |                  | Contrast                 |  | Adjust the contrast.  |
|                   |                  | Red                      |  | Adjust the red colour.  |
| Green             |                  | Adjust the green colour. |  |   |
| Blue              |                  | Adjust the blue colour.  |  |   |
| Job Save Location | -                | -                        | Select the location where you want to save print jobs.   |   |
| Reset Printer     | -                | -                        | Restore the printer settings to the factory settings.  |   |

## [Network]

### [All Settings] > [Network]

| Level 3   | Level 4 | Level 5                           | Level 6       | Descriptions  |
|-----------|---------|-----------------------------------|---------------|---|
| Wired LAN | TCP/IP  | BOOT Method                       | IP Boot Tries | Select the Boot method that best suits your needs.  |
|           |         | IP Address                        | -             | Enter the IP address.   |
|           |         | Subnet Mask                       | -             | Enter the Subnet mask.  |
|           |         | Gateway                           | -             | Enter the Gateway address.  |
|           |         | Node Name                         | -             | Enter the Node name.<br>(up to 32 characters)   |
|           |         | WINS Configuration                | -             | Select the WINS configuration mode.   |
|           |         | WINS Server                       | Primary       | Specify the IP address of the primary WINS server.  |
|           |         |                                   | Secondary     | Specify the IP address of the secondary WINS server.  |
|           |         | DNS Server                        | Primary       | Specify the IP address of the primary DNS server.   |
|           |         |                                   | Secondary     | Specify the IP address of the secondary DNS server.   |
|           |         | APIPA                             | -             | Set the machine to allocate the IP address from the link-local address range automatically. |
| IPv6      | -       | Turn the IPv6 protocol on or off. |               |   |

| Level 3                  | Level 4                   | Level 5                   | Level 6   | Descriptions   |
|--------------------------|---------------------------|---------------------------|---|--|
| <b>Wired LAN</b>         | <b>Ethernet</b>           | -                         | -   | Select the Ethernet link mode.   |
|                          | <b>Wired Status</b>       | -                         | -   | View the current wired status.   |
|                          | <b>MAC Address</b>        | -                         | -   | View the machine's MAC address.  |
|                          | <b>Set to Default</b>     | -                         | -   | Restore the wired network settings to the factory settings.                |
|                          | <b>Wired Enable</b>       | -                         | -   | Turn the Wired LAN interface on or off manually.                           |
| <b>WLAN (Wi-Fi)</b><br>1 | <b>Find Wi-Fi Network</b> | -                         | -   | Configure your wireless network settings manually.                         |
|                          | <b>TCP/IP</b>             | <b>BOOT Method</b>        | <b>IP Boot Tries</b>  | Select the Boot method that best suits your needs.                         |
|                          |                           | <b>IP Address</b>         | -   | Enter the IP address.  |
|                          |                           | <b>Subnet Mask</b>        | -   | Enter the Subnet mask.   |
|                          |                           | <b>Gateway</b>            | -   | Enter the Gateway address.   |
|                          |                           | <b>Node Name</b>          | -   | Enter the Node name.<br>(up to 32 characters)                              |
|                          |                           | <b>WINS Configuration</b> | -   | Select the WINS configuration mode.  |
|                          |                           | <b>WINS Server</b>        | <b>Primary</b>  | Specify the IP address of the primary WINS server.                         |
|                          |                           |                           | <b>Secondary</b>  | Specify the IP address of the secondary WINS server.                       |
|                          |                           | <b>DNS Server</b>         | <b>Primary</b>  | Specify the IP address of the primary DNS server.                          |
|                          |                           |                           | <b>Secondary</b>  | Specify the IP address of the secondary DNS server.                        |
|                          | <b>APIPA</b>              | -                         | Set the machine to allocate the IP address from the link-local address range automatically. |  |
|                          | <b>IPv6</b>               | -                         | Turn the IPv6 protocol on or off.   |  |
|                          | <b>WPS/Push Button</b>    | -                         | -   | Configure your wireless network settings using the one-button push method. |
|                          | <b>WPS/PIN Code</b>       | -                         | -   | Configure your wireless network settings using WPS with a PIN.             |
|                          | <b>WLAN Status</b>        | <b>Status</b>             | -   | View the current wireless network status.                                  |
|                          |                           | <b>Signal</b>             | -   | View the current wireless network signal strength.                         |
|                          |                           | <b>SSID</b>               | -   | View the current SSID.   |
|                          |                           | <b>Comm. Mode</b>         | -   | View the current Communication mode.                                       |
|                          | <b>MAC Address</b>        | -                         | -   | View the machine's MAC address.  |
|                          | <b>Set to Default</b>     | -                         | -   | Restore the wireless network settings to the factory settings.             |
|                          | <b>WLAN Enable</b>        | -                         | -   | Turns the wireless interface on or off.                                    |

1 The wireless network connection can be used only when the optional Wireless Module is installed.



| Level 3                   | Level 4  | Level 5     | Level 6          | Descriptions   |  |
|---------------------------|--|-------------|------------------|--|--|
| Wi-Fi Direct <sup>1</sup> | Manual   | -           | -                | Configure your Wi-Fi Direct network settings manually.                                   |  |
|                           | Group Owner  | -           | -                | Set your machine as the Group Owner.   |  |
|                           | Push Button  | -           | -                | Configure your Wi-Fi Direct network settings using the one-button push method.           |  |
|                           | PIN Code   | -           | -                | Configure your Wi-Fi Direct network settings using WPS with a PIN code.                  |  |
|                           | Device Information   | Device Name | -                | -  | View your machine's device name.   |
|                           |  | SSID        | -                | -  | View the Group Owner's SSID.<br>When the machine is not connected, the LCD displays Not Connected.   |
|                           |  | IP Address  | -                | -  | View your machine's current IP Address.  |
|                           | Status Information   | Status      | -                | -  | View the current Wi-Fi Direct network status.  |
|                           |  | Signal      | -                | -  | View the current Wi-Fi Direct network signal strength.<br>When your machine acts as Group Owner, the LCD always indicates a strong signal. |
|                           | I/F Enable   | -           | -                | -  | Turn the Wi-Fi Direct connection on or off.  |
| NFC                       | -  | -           | -                | Turn the NFC function on or off.   |  |
| E-mail/IFAX               | Mail Address   | -           | -                | Enter the email address.   |  |
|                           | Setup Server   | SMTP        | Server           | Enter the SMTP server name and address.  |  |
|                           |  |             | Port             | Enter the SMTP port number.  |  |
|                           |  |             | Auth. for SMTP   | Select the Security method for email notification.                                       |  |
|                           |  |             | SSL/TLS          | Send or receive an email via an email server that requires secure SSL/TLS communication. |  |
|                           |  |             | Verify Cert.     | Verify the SMTP Server Certificate automatically.  |  |
|                           |  | POP3/IMAP4  | Protocol         | Select the protocol for receiving an email from the server.                              |  |
|                           |  |             | Server           | Enter the server name and address.   |  |
|                           |  |             | Port             | Enter the port number.   |  |
|                           |  |             | Mailbox Name     | Enter the mailbox name.<br>(Up to 255 characters)  |  |
|                           |  |             | Mailbox Password | Enter the password to login to the server.<br>(Up to 128 characters)                     |  |
| Select Folder             | Select the specified folder in the mailbox using the IMAP4 protocol. |             |                  |  |  |

| Level 3              | Level 4        | Level 5             | Level 6   | Descriptions  |
|----------------------|----------------|---------------------|---|---|
| E-mail/IFAX          | Setup Server   | POP3/IMAP4          | SSL/TLS   | Send or receive an email via an email server that requires secure SSL/TLS communication.  |
|                      |                |                     | Verify Cert.  | Verify the SMTP Server Certificate automatically.   |
|                      |                |                     | APOP  | Turn APOP on or off.  |
|                      | Setup Mail RX  | Auto Polling        | Auto Polling  | Check the server for new messages automatically.  |
|                      |                |                     | Poll Frequency  | Set the interval for checking new messages on the server.   |
|                      |                | Header              | -   | Select the contents of the email header to be printed.  |
|                      |                | Del/Read Error Mail | -   | The POP3 server deletes error emails automatically. The IMAP4 server deletes error emails automatically after you read them.  |
|                      |                | Notification        | -   | Receive notification messages.  |
|                      | Setup Mail TX  | Sender Subject      | -   | View the subject.   |
|                      |                | Size Limit          | Size Limit  | Limit the size of email documents.  |
|                      |                |                     | Maximum Size (MB)   |   |
|                      | Notification   | -                   | Send notification messages.                               |   |
|                      | Setup Relay    | Relay Broadcast     | -   | Relay a document to another fax machine.  |
|                      |                | Relay Domain        | Relay XX  | Register the Domain name.   |
|                      |                | Relay Report        | -   | Print the relay Broadcast Report.   |
|                      | Report Setting | E-mail              | XMIT Report   | Select the initial setup for the Transmission Verification Report.  |
| IFAX                 |                | XMIT Report         |   |   |
| Manual Receive       | -              | -                   | Check the POP3 or IMAP4 server for new messages manually. |   |
| Web Connect Settings | Proxy Settings | Proxy Connection    | -   | Change the Web connection settings.   |
|                      |                | Address             | -   |   |
|                      |                | Port                | -   |   |
|                      |                | User Name           | -   |   |
|                      |                | Password            | -   |   |
| Fax to Server        | Fax to Server  | -                   | -   | Select the network connection type.   |
|                      | Prefix         | -                   | -   |   |
|                      | Suffix         | -                   | -   |   |
| IPsec                | -              | -                   | -   | IPsec is an optional security feature of the IP protocol that provides authentication and encryption services. We recommend contacting your network administrator before changing this setting. |
| Network Reset        | -              | -                   | -   | Restore all network settings back to the factory settings.  |

## [Print Reports]

[All Settings] > [Print Reports]

| Level 3                  | Level 4      | Descriptions   |
|--------------------------|--------------|--|
| XMIT Verify              | View on LCD  | Display Transmission Verification Reports about sent faxes.  |
|                          | Print Report | Print a Transmission Verification Report of your last transmission.  |
| Address Book             | -            | Print a list of names and numbers stored in the Address Book.  |
| Fax Journal              | -            | Print a list of information about your last 200 incoming and outgoing faxes.<br>(TX means Transmit. RX means Receive.) |
| User Settings            | -            | Print a list of your settings.   |
| Printer Settings         | -            | Print a list of your Printer settings.   |
| Network Configuration    | -            | Print a list of your Network settings.   |
| Print File List          | -            | Print a list of data saved in the machine's memory.  |
| Drum Dot Print           | -            | Print the Drum Dot Check Sheet.  |
| WLAN Report <sup>2</sup> | -            | Print the wireless LAN connection results.   |

## [Machine Info.]

[All Settings] > [Machine Info.]

| Level 3                 | Level 4          | Level 5         | Descriptions   |
|-------------------------|------------------|-----------------|--|
| Serial No.              | -                | -               | Check your machine's serial number.                      |
| Firmware Version        | Main Version     | -               | Check your machine's firmware version.                   |
|                         | Sub3 Version     | -               |  |
|                         | Security Version | -               |  |
| Firmware Update         | -                | -               | Update your machine to the latest firmware.              |
| Firmware Auto Check     | -                | -               | View firmware information on the Home screen.            |
| Page Counter            | Total            | Colour          | Check the total number of pages the machine has printed. |
|                         |                  | Black and White |  |
|                         | Fax              | -               |  |
|                         | Copy             | Colour          |  |
|                         |                  | Black and White |  |
|                         | Print            | Colour          |  |
| Black and White         |                  |                 |  |
| Other                   | Colour           |                 |  |
|                         | Black and White  |                 |  |
| Parts Life <sup>1</sup> | Drum             | -               | Display the remaining life of the drum unit.             |
|                         | Belt             | -               | Display the remaining life of the belt unit.             |

<sup>2</sup> The wireless network connection can be used only when the optional Wireless Module is installed.

| Level 3                 | Level 4               | Level 5 | Descriptions                                  |
|-------------------------|-----------------------|---------|---|
| Parts Life <sup>1</sup> | Fuser                 | -       | Display the remaining life of the fuser unit. |
|                         | Laser Unit            | -       | Display the remaining life of the laser unit. |
|                         | PF Kit MP             | -       | Display the remaining life of the PF Kit MP.  |
|                         | PF Kit 1              | -       | Display the remaining life of the PF Kit 1.   |
|                         | PF Kit 2 <sup>2</sup> | -       | Display the remaining life of the PF Kit 2.   |
|                         | PF Kit 3 <sup>2</sup> | -       | Display the remaining life of the PF Kit 3.   |
|                         | PF Kit 4 <sup>2</sup> | -       | Display the remaining life of the PF Kit 4.   |
|                         | PF Kit 5 <sup>3</sup> | -       | Display the remaining life of the PF Kit 5.   |

<sup>1</sup> The parts life is approximate and may vary by type of use.

<sup>2</sup> Available if the Optional Tray(s) is installed.

<sup>3</sup> Available if the Optional Tray(s) is installed.

## [Initial Setup]

### [All Settings] > [Initial Setup]

| Level 3   | Level 4            | Descriptions   |
|---|--------------------|--|
| Date & Time                                       | Date               | Add the date and time on the screen and in the headings of the faxes you send.   |
|   | Time               |  |
|   | Clock Type         | Select the time format (12-hour or 24-hour).   |
|   | Auto Daylight      | Set the machine to change automatically for Daylight Saving Time.  |
|   | Time Zone          | Set your time zone.  |
| Station ID  | Fax                | Enter your name and fax number so it appears on each page you fax.   |
|   | Tel                |  |
|   | Name               |  |
| Tone/Pulse<br>(Available only for some countries) | -                  | Select the dialling mode.  |
| Dial Tone   | -                  | Shorten the dial tone detect pause.  |
| Phone Line Set                                    | -                  | Select the telephone line type.  |
| Compatibility                                     | -                  | Adjust the equalisation for transmission difficulties.<br>VoIP service providers offer fax support using various standards. If you regularly experience fax transmission errors, select Basic (for VoIP).    |
| Reset   | Machine Reset      | Restore the machine settings that you have changed.  |
|   | Network Reset      | Restore all network settings back to the factory settings.   |
|   | Address Book & Fax | Erase all stored phone numbers and fax settings.   |
|   | All Settings       | Restore all the machine's settings back to the factory settings and delete the personal data in the memory. You cannot see the data on the machine.  |
|   | Factory Reset      | Restore all the machine settings back to the factory settings and delete the personal data in the machine's memory. We recommend using this menu option if you want to delete all the data from the machine. |
| Local Language                                    | -                  | Change your LCD language.  |

| Level 3                             | Level 4 | Descriptions |
|-------------------------------------|---------|--------------|
| (Available only for some countries) |         |              |

## [Admin Settings]



### [Admin Settings]

| Level 2                    | Level 3                   | Level 4 | Level 5  | Descriptions  |                              |
|----------------------------|---------------------------|---------|--|---|------------------------------|
| Home Screen Settings       | Icons                     | -       | -  | Delete icons, add icons or move icons to other places on the Home screens.                  |                              |
|                            | Background Colour         | -       | -  | Change the background colour on the touchscreen to White or Black.                          |                              |
|                            | Tabs                      | Rename  | Tab 1  | -   | Change the name of the tabs. |
|                            |                           |         | Tab 2  |   |                              |
|                            |                           |         | Tab 3  |   |                              |
|                            |                           |         | Tab 4  |   |                              |
|                            |                           |         | Tab 5  |   |                              |
| Tab 6                      |                           |         |  |   |                              |
|                            | Main Home Screen          | -       | Set your Main Home screen.   |   |                              |
| Display Information        | IP Address                | -       | Select whether to display your machine's IP Address on the Home screens. |   |                              |
| Home Screen Settings Reset | -                         | -       | Restore Home screen settings back to the factory settings.               |   |                              |
| Other Screen Settings      | Copy Screen               | -       | -  | Set the default Copy screen settings.   |                              |
|                            | Scan Screen               | -       | -  | Set the default Scan screen settings.   |                              |
| Restriction Management     | User Restriction Function | -       | -  | Enable or disable the restriction function, such as Secure Function Lock.                   |                              |
|                            | Setting Lock              | -       | -  | Restrict unauthorised users from changing the machine's settings.                           |                              |
|                            | Setting Lock Details      | -       | -  | Select the specific machine settings you want to restrict unauthorised users from changing. |                              |
| Password                   | -                         | -       | -  | Register or change the password to log on to the Admin Settings menu.                       |                              |



### Related Information

- [Settings and Features Tables](#)

## Feature Tables

- >> [Wired Network Setup](#)
- >> [Wi-Fi® Setup](#)
- >> [\[Toner\]](#)
- >> [\[Admin Settings\]](#)
- >> [\[Fax\] \(When Fax Preview is Off\)](#)
- >> [\[Fax\] \(When Fax Preview is On\)](#)
- >> [\[Copy\]](#)
- >> [\[Scan\]](#)
- >> [\[Secure Print\]](#)
- >> [\[Web\]](#)
- >> [\[Apps\]](#)
- >> [\[USB\]](#)
- >> [Shortcuts](#)
- >> [\[2 in 1 ID Copy\]](#)

### Wired Network Setup



#### (Wired Network Setup)

| Level 3        | Descriptions  |
|----------------|---|
| TCP/IP         | Change the TCP/IP settings.                                 |
| Ethernet       | Select the Ethernet link mode.                              |
| Wired Status   | View the current wired status.                              |
| MAC Address    | View the machine's MAC address.                             |
| Set to Default | Restore the wired network settings to the factory settings. |
| Wired Enable   | Turn the Wired LAN interface on or off manually.            |

### Wi-Fi® Setup



#### (Wi-Fi® Setup)

| Level 3             | Descriptions   |
|---------------------|--|
| Find Wi-Fi Network  | Configure your wireless network settings manually.                         |
| TCP/IP<br>1         | Change the TCP/IP settings.  |
| WPS/Push Button     | Configure your wireless network settings using the one-button push method. |
| WPS/PIN Code<br>1   | Configure the wireless network settings using WPS with a PIN code.         |
| WLAN Status<br>1    | Display the wireless network connection status.                            |
| MAC Address<br>1    | Display the MAC address of the machine.                                    |
| Set to Default<br>1 | Restore wireless network settings of your machine to the factory settings. |
| WLAN Enable<br>1    | Turn the wireless interface on or off.                                     |

<sup>1</sup> Available after a Wi-Fi® connection has been configured.

## NOTE

The wireless network connection can be used only when the optional Wireless Module is installed.

### [Toner]



#### [Toner]

| Level 3           | Level 4          | Descriptions   |
|-------------------|------------------|--|
| Toner Life        | -                | View the approximate remaining toner life for each colour. |
| Test Print        | -                | Print a test page.   |
| Colour Correction | Correction Start | Initiate colour calibration to check and correct colours.  |
|                   | Reset            | Reset the calibration parameters to the default settings.  |

### [Admin Settings]



#### [Admin Settings]

| Level 2        | Descriptions  |
|----------------|---|
| Admin Settings | Change the screen settings and restrict use of the machine. |

### [Fax] (When Fax Preview is Off)



#### [Fax] (When Fax Preview is Off)

| Level 3        | Level 4   | Level 5         | Level 6    | Descriptions   |
|----------------|---|-----------------|------------|--|
| Redial / Pause | -   | -               | -          | Redial the last number called. When you are entering a fax or telephone number on the control panel, Redial changes to Pause on the LCD. Press Pause when you need a delay while dialling numbers, such as access codes and credit card numbers. You can also store a pause when you set up addresses. |
| Tel / R        | -   | -               | -          | Tel changes to R when PBX is selected as the telephone line type. You can use R to gain access to an outside line or to transfer a call to another extension when connected to a PBX.  |
| Address Book   | <br>(Search) | -               | -          | Search within the Address Book.  |
|                | Edit  | Add New Address | Name       | Store Address Book numbers, set up Group numbers for Broadcasting, change and delete Address Book numbers.   |
|                |   |                 | Address    |  |
|                |   | Setup Groups    | Name       |  |
|                |   |                 | Add/Delete |  |
| Change         | (Select Address)  |                 |            |  |
| Delete         | (Select Address)  |                 |            |  |

| Level 3          | Level 4               | Level 5                | Level 6  | Descriptions   |
|------------------|-----------------------|------------------------|--|--|
| Address Book     | (Select Address Book) | Apply                  | -  | Start sending a fax using the Address Book.  |
| Call History     | Outgoing Call         | (Select Outgoing Call) | Apply  | Select a number from the Outgoing Call history, and then send a fax to it, add it to the Address Book, or delete it. |
|                  |                       |                        | Edit   |  |
| Fax Start        | -                     | -                      | -  | Send a fax.  |
| Options          | Fax Resolution        | -                      | -  | Set the resolution for outgoing faxes.   |
|                  | Contrast              | -                      | -  | Adjust the contrast.   |
|                  | 2-sided Fax           | -                      | -  | Set the 2-sided scanning format.   |
|                  | Glass Scan Size       | -                      | -  | Adjust the scan area of the scanner glass to the size of the document.   |
|                  | Broadcasting          | Add Number             | Add Number   | Send the same fax message to more than one fax number.   |
|                  |                       |                        | Add from Address book                                    |  |
|                  |                       |                        | Search in Address book                                   |  |
|                  | Preview               | -                      | -  | Preview a fax message before you send it.  |
|                  | Delayed Fax           | Delayed Fax            | -  | Set the time of day the delayed faxes will be sent.  |
|                  |                       | Set Time               | -  |  |
|                  | Real Time TX          | -                      | -  | Send a fax without using the memory.   |
|                  | Coverpage Setup       | Coverpage Setup        | -  | Set the machine to automatically send a pre-programmed cover page.   |
|                  |                       | Coverpage Note         | -  |  |
| Total Pages      |                       | -                      |  |  |
| Overseas Mode    | -                     | -                      | Set to On if you have difficulty sending faxes overseas. |  |
| Set New Default  | -                     | -                      | Save your settings as the default.                       |  |
| Factory Reset    | -                     | -                      | Restore all settings back to the factory settings.       |  |
| Save as Shortcut | -                     | -                      | -  | Save the current settings as a shortcut.   |

### [Fax] (When Fax Preview is On)



### [Fax] (When Fax Preview is On)

| Level 3       | Level 4        | Level 5 | Descriptions   |
|---------------|----------------|---------|--|
| Sending Faxes | Redial / Pause | -       | Redial the last number called. When you are entering a fax or telephone number on the control panel, Redial changes to Pause on the LCD. Press Pause when you need a delay while dialling numbers, such as access codes and credit card numbers. You can also store a pause when you set up addresses. |
|               | Tel / R        | -       | Tel changes to R when PBX is selected as the telephone line type. You can use R to gain access to an outside line or to  |



| Level 3        | Level 4          | Level 5                | Descriptions   |
|----------------|------------------|------------------------|--|
| Sending Faxes  |                  |                        | transfer a call to another extension when connected to a PBX.  |
|                | Address Book     | -                      | Select the address of the recipient from the address book.   |
|                | Call History     | -                      | Select a number from the Outgoing Call history, and then send a fax to it, add it to the Address Book, or delete it. |
|                | Fax Start        | -                      | Send a fax.  |
|                | Options          | -                      | Select your settings.  |
|                | Save as Shortcut | -                      | Save the current settings as a shortcut.   |
| Received Faxes | Print/Delete     | Print All (New Faxes)  | Print the new received faxes.  |
|                |                  | Print All (Old Faxes)  | Print the old received faxes.  |
|                |                  | Delete All (New Faxes) | Delete the new received faxes.   |
|                |                  | Delete All (Old Faxes) | Delete the old received faxes.   |
| Address Book   | -                | -                      | Select the address of the recipient from the address book.   |
| Call History   | -                | -                      | Select a number from the Outgoing Call history, and then send a fax to it, add it to the Address Book, or delete it. |

[Copy]



[Copy]

| Level 3               | Level 4 | Level 5               | Descriptions                             |   |
|-----------------------|---------|-----------------------|--|---|
| Mono Start            | -       | -                     | Make a monochrome or greyscale copy.     |   |
| Colour Start          | -       | -                     | Make a colour copy.                      |   |
| ID                    | -       | -                     | Make a copy of your ID card.             |   |
| Interrupt             | -       | -                     | Interrupt a print job with a copy job.   |   |
| > (more Copy options) | Receipt | Mono Start            | Set the preset copy settings of Receipt. |   |
|                       |         | Colour Start          |  |   |
|                       |         | ID                    |  |   |
|                       |         | Interrupt             |  |   |
|                       |         | Save as Shortcut      |  |   |
|                       |         | > (more Copy options) |  |   |
|                       |         | Options               |  |   |
|                       | Normal  |                       | Mono Start                               | Set the preset copy settings of Normal. |
|                       |         |                       | Colour Start                             |   |
|                       |         |                       | ID                                       |   |
|                       |         |                       | Interrupt                                |   |
|                       |         |                       | Save as Shortcut                         |   |
|                       |         |                       | > (more Copy options)                    |   |

| Level 3               | Level 4                 | Level 5                                     | Descriptions                                       |
|-----------------------|-------------------------|---|--|
| > (more Copy options) | <b>Normal</b>           | <b>Options</b>                              | Set the preset copy settings of Normal.            |
|                       | <b>2sided(1⇒2)</b>      | <b>Mono Start</b>                           | Set the preset copy settings of 2-sided(1⇒2).      |
|                       |                         | <b>Colour Start</b>                         |  |
|                       |                         | <b>ID</b>                                   |  |
|                       |                         | <b>Interrupt</b>                            |  |
|                       |                         | <b>Save as Shortcut</b>                     |  |
|                       |                         | > (more Copy options)                       |  |
|                       |                         | <b>Options</b>                              |  |
|                       | <b>2sided(2⇒2)</b>      | <b>Mono Start</b>                           | Set the preset copy settings of 2-sided(2⇒2).      |
|                       |                         | <b>Colour Start</b>                         |  |
|                       |                         | <b>ID</b>                                   |  |
|                       |                         | <b>Interrupt</b>                            |  |
|                       |                         | <b>Save as Shortcut</b>                     |  |
|                       |                         | > (more Copy options)                       |  |
|                       |                         | <b>Options</b>                              |  |
|                       | <b>2in1 (ID)</b>        | <b>Mono Start</b>                           | Set the preset copy settings of 2in1(ID).          |
|                       |                         | <b>Colour Start</b>                         |  |
|                       |                         | <b>ID</b>                                   |  |
|                       |                         | <b>Interrupt</b>                            |  |
|                       |                         | <b>Save as Shortcut</b>                     |  |
|                       |                         | > (more Copy options)                       |  |
| <b>Options</b>        |                         |   |  |
| <b>2in1</b>           | <b>Mono Start</b>       | Set the preset copy settings of 2in1.       |  |
|                       | <b>Colour Start</b>     |   |  |
|                       | <b>ID</b>               |   |  |
|                       | <b>Interrupt</b>        |   |  |
|                       | <b>Save as Shortcut</b> |   |  |
|                       | > (more Copy options)   |   |  |
|                       | <b>Options</b>          |   |  |
| <b>Paper Save</b>     | <b>Mono Start</b>       | Set the preset copy settings of Paper Save. |  |
|                       | <b>Colour Start</b>     |   |  |
|                       | <b>ID</b>               |   |  |
|                       | <b>Interrupt</b>        |   |  |
|                       | <b>Save as Shortcut</b> |   |  |
|                       | > (more Copy options)   |   |  |
|                       | <b>Options</b>          |   |  |
| <b>Options</b>        | <b>Quality</b>          | -   | Select the Copy resolution for your document type. |
|                       | <b>Tray Use</b>         | -   | Select the tray you want to use.                   |
|                       | <b>Enlarge/Reduce</b>   | 100%  | -  |
|                       |                         | <b>Enlarge</b>                              | Select an enlargement ratio for the next copy.     |
|                       |                         | <b>Reduce</b>                               | Select a reduction ratio for the next copy.        |

| Level 3          | Level 4                  | Level 5                       | Descriptions   |
|------------------|--------------------------|-------------------------------|--|
| Options          | Enlarge/Reduce           | Custom (25-400%)              | Enter an enlargement or reduction ratio.   |
|                  | Density                  | -                             | Adjust the density.  |
|                  | Remove Background Colour | -                             | Change the amount of background colour that is removed.                                  |
|                  | 2-sided Copy             | Layout                        | Turn off or turn on 2-sided copying and select flip on long edge or flip on short edge.  |
|                  | 2-sided Copy Page Layout | -                             | Select a page layout option when you make 2-sided N in 1 copies from a 2-sided document. |
|                  | Contrast                 | -                             | Adjust the contrast.   |
|                  | Stack/Sort               | -                             | Select to stack or sort multiple copies.   |
|                  | 2in1/1in1                | -                             | If you select 2 in 1 (ID), you can select the layout options.                            |
|                  | Page Layout              | -                             | Make N in 1 and 2 in 1 (ID) copies.  |
|                  | Auto Deskew              | -                             | Set the machine to correct document skewing automatically.                               |
| Colour Adjust    | -                        | Adjust the colour for copies. |  |
| Save as Shortcut | -                        | -                             | Save the current settings as a shortcut.   |

### [Scan]



### [Scan]

| Level 3             | Level 4      | Level 5                     | Level 6 | Descriptions                         |  |
|---------------------|--------------|-----------------------------|---------|--------------------------------------|--|
| to USB              | Scan Actions | -                           | -       | Scan documents to a USB flash drive. |  |
|                     | Options      | 2-sided Scan                | -       |                                      |  |
|                     |              | Colour Setting              | -       |                                      |  |
|                     |              | Resolution                  | -       |                                      |  |
|                     |              | File Type                   | -       |                                      |  |
|                     |              | Document Size               | -       |                                      |  |
|                     |              | Brightness                  | -       |                                      |  |
|                     |              | Contrast                    | -       |                                      |  |
|                     |              | File Name                   | -       |                                      |  |
|                     |              | File Name Style             | -       |                                      |  |
|                     |              | File Size                   | -       |                                      |  |
|                     |              | Auto Deskew                 | -       |                                      |  |
|                     |              | Skip Blank Page             | -       |                                      |  |
|                     |              | Skip Blank Page Sensitivity | -       |                                      |  |
|                     |              | Remove Background Colour    | -       |                                      |  |
| Margin Settings     | -            |                             |         |                                      |  |
| Moire Reduction     | -            |                             |         |                                      |  |
| Document Separation | -            | Document Separation         |         |                                      |  |

| Level 3          | Level 4          | Level 5   | Level 6             | Descriptions  |   |
|------------------|------------------|---|---------------------|---|---|
| to USB           | Options          | Document Separation   | Number of Documents | Scan documents to a USB flash drive.  |   |
|                  |                  |   | Number of Pages     |   |   |
|                  |                  | B&W TIFF Compress   | -                   |   |   |
|                  |                  | Set New Default   | -                   |   |   |
|                  | Factory Reset    | -   |                     |   |   |
|                  | Save as Shortcut | -   | -                   |   |   |
| Start            | -                | -   | -                   |   |   |
| to My E-mail     | -                | -   | -                   | Scan a monochrome or a colour document to your email address.                                 |   |
| to My Folder     | -                | -   | -                   | Send scanned data to your folder in the CIFS server on your local network or on the Internet. |   |
| to PC            | to File          | Scan Actions<br>(Select USB or PC)  | -                   | Scan documents and save them to a folder on your computer.                                    |   |
|                  |                  |   | Options             |   |   |
|                  |                  |   | Save as Shortcut    |   |   |
|                  | to OCR           | Scan Actions<br>(Select USB or PC)  | -                   | Convert your scanned document to an editable text file.                                       |   |
|                  |                  |   | Options             |   |   |
|                  |                  |   | Save as Shortcut    |   |   |
|                  | to Image         | Scan Actions<br>(Select USB or PC)  | -                   | Scan photos or graphics into your graphics applications.                                      |   |
|                  |                  |   | Options             |   |   |
|                  |                  |   | Save as Shortcut    |   |   |
|                  | to E-mail        | Scan Actions<br>(Select USB or PC)  | -                   | Send a scanned document as an email attachment.   |   |
|                  |                  |   | Options             |   |   |
|                  |                  |   | Save as Shortcut    |   |   |
| to E-mail Server | Scan Actions     | -   | -                   | Scan a monochrome or a colour document to the email address you want.                         |   |
|                  | Cancel           | -   | -                   |   |   |
|                  | Manual           | -   | -                   |   |   |
|                  | Address Book     | <br>(Search) | -                   |   | - |
|                  |                  | Edit<br>(Select Address Book)   | -                   |   | - |
|                  | Next             | Destinations  | -                   |   | - |

| Level 3   | Level 4                               | Level 5          | Level 6 | Descriptions   |
|---|---------------------------------------|------------------|---------|--|
| to E-mail Server  | Next                                  | Options          | -       | Scan a monochrome or a colour document to the email address you want.        |
|   |                                       | Save as Shortcut | -       |  |
|   |                                       | Start            | -       |  |
|   | Destinations                          | (Select Address) | -       |  |
| to FTP/SFTP   | Scan Actions<br>(Select Profile name) | Options          | -       | Send scanned data via FTP/SFTP.  |
|   |                                       | Save as Shortcut | -       |  |
|   |                                       | Start            | -       |  |
|   | Scan Actions                          | -                | -       |  |
| to Network  | (Select Profile name)                 | Options          | -       | Send scanned data to a CIFS server on your local network or on the Internet. |
|   |                                       | Save as Shortcut | -       |  |
|   |                                       | Start            | -       |  |
|   | Scan Actions                          | -                | -       |  |
| to SharePoint   | (Select Profile name)                 | Options          | -       | Send scanned data via a SharePoint server.                                   |
|   |                                       | Save as Shortcut | -       |  |
|   |                                       | Start            | -       |  |
|   | Scan Actions                          | -                | -       |  |
| to Web  | -                                     | -                | -       | Upload the scanned data to an Internet service.                              |
| WS Scan<br>(Appears when you install a Web Services Scanner, which is displayed in your computer's Network explorer.) | Scan Actions                          | -                | -       | Scan data using the Web Service protocol.                                    |
|   | Scan                                  | -                | -       |  |
|   | Scan for E-mail                       | -                | -       |  |
|   | Scan for Fax                          | -                | -       |  |
|   | Scan for Print                        | -                | -       |  |

### [Secure Print]



### [Secure Print]

| Level 2      | Descriptions  |
|--------------|---|
| Secure Print | You can print data saved in the machine's memory or USB flash drive when you enter your password.<br>Active only when the machine or USB flash drive has secure print data. |

### [Web]



### [Web]

| Level 2 | Descriptions  |
|---------|---|
| Web     | Connect the Brother machine to an Internet service. |

## [Apps]



### [Apps]

| Level 2 | Descriptions   |
|---------|--|
| Apps    | Connect the Brother machine to the Brother Apps service. |

## [USB]



### [USB]

| Level 2 | Level 3      | Descriptions                                      |
|---------|--------------|---|
| USB     | Scan to USB  | Scan documents to a USB flash drive.              |
|         | Direct Print | Print the data directly from the USB flash drive. |

## Shortcuts

### + (Shortcuts)

| Level 3   | Level 4           | Level 5                                    | Descriptions   |  |
|---|-------------------|--|--|--|
| Add Shortcut  | Copy              | -  | Select the settings you want.  |  |
|   | Fax               | -  | Select the settings you want.  |  |
|   | Scan              | to File                                    |  | Scan documents and save them to a folder on your computer.                   |
|   |                   | to OCR                                     |  | Convert your scanned document to an editable text file.                      |
|   |                   | to Image                                   |  | Scan photos or graphics into your graphics applications.                     |
|   |                   | to USB                                     |  | Scan documents to a USB flash drive.   |
|   |                   | to E-mail                                  |  | Send a scanned document as an email attachment.                              |
|   |                   | to E-mail Server                           |  | Scan a monochrome or a colour document to the email address you want.        |
|   |                   | to Network                                 |  | Send scanned data to a CIFS server on your local network or on the Internet. |
|   |                   | to FTP/SFTP                                |  | Send scanned data via FTP/SFTP.  |
| to SharePoint   |                   | Send scanned data via a SharePoint server. |  |  |
| Web   | -                 |  | Connect the Brother machine to an Internet service.<br>Web services may have been added and service names may have been changed by the provider since this document was published. |  |
| Apps  | -                 |  | Connect the Brother machine to the Brother Apps service.   |  |
| These lists appears when each Shortcut name is pressed for two seconds. | Rename            | -  | Change the shortcut name.  |  |
|   | Edit              | -  | Change the shortcut settings.  |  |
|   | Delete            | -  | Delete the shortcut.   |  |
|   | Register Card/NFC | -  | Assign a Shortcut to an ID card.   |  |

| Level 3   | Level 4         | Level 5 | Descriptions                       |
|---|-----------------|---------|------------------------------------|
| These lists appears when each Shortcut name is pressed for two seconds. | Delete Card/NFC | -       | Remove a Shortcut from an ID card. |

**[2 in 1 ID Copy]**

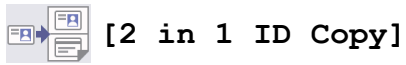

| Level 2        | Descriptions   |
|----------------|--|
| 2 in 1 ID Copy | Copy both sides of an identification card onto one page. |

**✓ Related Information**

- [Settings and Features Tables](#)

## **Change Machine Settings from Your Computer**

- [Change Machine Settings Using Web Based Management](#)
- [Check Your Machine's Network Settings](#)



## Change Machine Settings Using Web Based Management

Web Based Management is a utility that uses a standard web browser to manage your machine using the Hyper Text Transfer Protocol (HTTP) or Hyper Text Transfer Protocol over Secure Socket Layer (HTTPS).

- [What is Web Based Management?](#)
- [Access Web Based Management](#)
- [Set or Change a Login Password for Web Based Management](#)

## What is Web Based Management?

Web Based Management is a utility that uses a standard web browser to manage your machine using the Hyper Text Transfer Protocol (HTTP) or Hyper Text Transfer Protocol over Secure Socket Layer (HTTPS).



- We recommend Microsoft Internet Explorer 11/Microsoft Edge for Windows, Safari 12/13 for Mac, Google Chrome™ for Android (4.x or later), and Google Chrome™/Safari for iOS (10.x or later). Make sure that JavaScript and Cookies are always enabled in whichever browser you use.
- Make sure your machine is On and connected to the same network as your computer, and that your network supports the TCP/IP protocol.

XXX-XXXX brother

Logout

This machine's default password is on the back of the machine and marked "Pwd". We recommend changing it immediately.

Home

Status

Auto Refresh Interval

General

Address Book

Fax

Copy

Print

Scan

### Status

---

**Device Status**

Sleep

Automatic Refresh

Off  
 On

---

**Toner Level**



BK C M Y

---

**Web Language**

Auto

---

**Device Location**

Contact :

Location :



### Related Information

- [Change Machine Settings Using Web Based Management](#)

## Access Web Based Management

- We recommend Microsoft Internet Explorer 11/Microsoft Edge for Windows, Safari 12/13 for Mac, Google Chrome™ for Android (4.x or later), and Google Chrome™/Safari for iOS (10.x or later). Make sure that JavaScript and Cookies are always enabled in whichever browser you use.
- We recommend using the HTTPS security protocol when configuring settings using Web Based Management.
- When you use HTTPS for Web Based Management configuration, your browser will display a warning dialog box. To avoid displaying the warning dialog box, you can install a self-signed certificate to use SSL/TLS communication. For more detailed information, see *Related Information*.
- The default password to manage this machine's settings is located on the back of the machine and marked "Pwd". We recommend immediately changing the default password to protect your machine from unauthorised access. You can also find the default password in the Network Configuration Report.

>> [Access Web Based Management from your Web Browser](#)

>> [Access Web Based Management from Brother iPrint&Scan \(Windows/Mac\)](#)

>> [Access Web Based Management from Brother Utilities \(Windows\)](#)

### Access Web Based Management from your Web Browser

1. Start your web browser.
2. Type "https://machine's IP address" in your browser's address bar (where "machine's IP address" is the machine's IP address).

For example:

https://192.168.1.2



If you are using a Domain Name System or enable a NetBIOS name, you can type another name, such as "SharedPrinter" instead of the IP address.

For example:

https://SharedPrinter

If you enable a NetBIOS name, you can also use the node name.

For example:

https://brnxxxxxxxxxxxx

The NetBIOS name can be found in the Network Configuration Report.

3. If required, type the password in the **Login** field, and then click **Login**.



The default password to manage this machine's settings is located on the back of the machine and marked "Pwd".

4. If you want to pin the navigation menu on the left side of the screen, click ☰ and then click 🌟.

You can now change the machine's settings.

### Access Web Based Management from Brother iPrint&Scan (Windows/Mac)

1. Start Brother iPrint&Scan.

- Windows

Launch  (Brother iPrint&Scan).

- Mac

In the **Finder** menu bar, click **Go > Applications**, and then double-click the iPrint&Scan icon.

The Brother iPrint&Scan screen appears.



2. If your Brother machine is not selected, click the **Select your Machine** button, and then select your model name from the list. Click **OK**.
3. Click  (**Machine Settings**).
4. Click **All Settings**.  
The Web Based Management page appears.
5. If required, type the password in the **Login** field, and then click **Login**.



---

The default password to manage this machine's settings is located on the back of the machine and marked "Pwd".

---

6. If you want to pin the navigation menu on the left side of the screen, click  and then click .

You can now change the machine's settings.



---

You can also access Web Based Management from Brother Mobile Connect for mobile devices.

---

## Access Web Based Management from Brother Utilities (Windows)



1. Launch  (**Brother Utilities**), and then click the drop-down list and select your model name (if not already selected).
2. Click **Tools** in the left navigation bar, and then click **Machine Settings**.  
The Web Based Management page appears.
3. If required, type the password in the **Login** field, and then click **Login**.



---

The default password to manage this machine's settings is located on the back of the machine and marked "Pwd".

---

4. If you want to pin the navigation menu on the left side of the screen, click  and then click .

You can now change the machine's settings.

If you change the protocol settings, you must restart the machine after clicking **Submit** to activate the configuration.

After configuring the settings, click **Logout**.



### Related Information

- [Change Machine Settings Using Web Based Management](#)

#### Related Topics:

- [Print the Network Configuration Report](#)
  - [Create a Self-signed Certificate](#)
  - [Install the Self-signed Certificate for Windows users with Administrator Rights](#)
  - [Use SSL/TLS](#)
-

## Set or Change a Login Password for Web Based Management

The default password to manage this machine's settings is located on the back of the machine and marked "Pwd". We recommend immediately changing the default password to protect your machine from unauthorised access.

1. Start your web browser.
2. Type "https://machine's IP address" in your browser's address bar (where "machine's IP address" is the machine's IP address).

For example:

https://192.168.1.2



---

If you are using a Domain Name System or enable a NetBIOS name, you can type another name, such as "SharedPrinter" instead of the IP address.

For example:

https://SharedPrinter

If you enable a NetBIOS name, you can also use the node name.

For example:

https://brnxxxxxxxxxxxx

The NetBIOS name can be found in the Network Configuration Report.

---

3. Do one of the following:
  - If you have previously set your own password, type it, and then click **Login**.
  - If you have not previously set your own password, type the default login password, and then click **Login**.
4. Go to the navigation menu, and then click **Administrator > Login Password**.



---

- The default password to manage this machine's settings is located on the back of the machine and marked "Pwd".

- Start from , if the navigation menu is not shown on the left side of the screen.

---

5. Following the on-screen **Login Password** guidelines, type your password in the **Enter New Password** field.
6. Retype the password in the **Confirm New Password** field.
7. Click **Submit**.



---

You can also change the lockout settings in the **Login Password** menu.

---



### Related Information

- [Change Machine Settings Using Web Based Management](#)
-

## Appendix

- [Specifications](#)
- [Supplies](#)
- [Important Information About Toner Cartridge Life](#)
- [Environmental and Compliance Information](#)
- [Accessories](#)
- [Brother Help and Customer Support](#)

## Specifications

- >> General Specifications
- >> Document Size Specification
- >> Print Media Specifications
- >> Fax Specifications
- >> Copy Specification
- >> Scanner Specifications
- >> Printer Specifications
- >> Interface Specifications
- >> Direct Print Feature Specifications
- >> Supported Protocols and Security Features
- >> Computer Requirements Specifications

### General Specifications

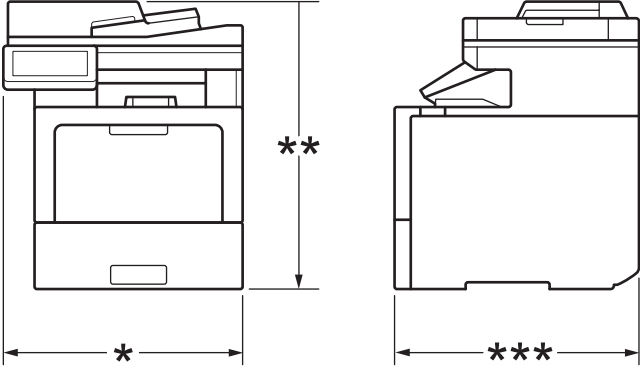
|   |   |  |
|---|---|--|
| <b>Printer Type</b>   |   | Laser  |
| <b>Print Method</b>   |   | Electrophotographic Laser Printer  |
| <b>Memory Capacity</b>  | <b>Standard</b>                                     | 2 GB   |
| <b>Machine display</b>  |   | Liquid Crystal Display (LCD) 7.0 in. (176.1 mm) TFT<br>Colour touchscreen LCD <sup>1</sup><br>Touchscreen 156.6 x 105.4 mm |
| <b>Power Source</b>   |   | 220 V to 240 V AC 50/60 Hz   |
| <b>Power Consumption</b><br>(Average)   | <b>Peak</b>   | Approximately 1,080 W  |
|   | <b>Printing</b> <sup>2</sup>                        | Approximately 770 W at 25°C  |
|   | <b>Printing</b><br><b>(Quiet Mode)</b> <sup>2</sup> | Approximately 430 W at 25°C  |
|   | <b>Copying</b> <sup>2</sup>                         | Approximately 730 W at 25°C  |
|   | <b>Copying</b><br><b>(Quiet Mode)</b> <sup>2</sup>  | Approximately 420 W at 25°C  |
|   | <b>Ready</b> <sup>2</sup>                           | Approximately 85 W at 25°C   |
|   | <b>Sleep</b> <sup>2</sup>                           | Approximately 16.8 W   |
|   | <b>Deep Sleep</b> <sup>2</sup>                      | Approximately 1.1 W  |
|   | <b>Power Off</b> <sup>2 3 4</sup>                   | Approximately 0.04 W   |
| <b>Dimensions</b><br>(Typical outline view)   |   | Unit: mm<br>* : 503<br>** : 586<br>*** : 541   |
|  |   |  |
| <b>Weights (with supplies)</b>  |   | <ul style="list-style-type: none"> <li>• (MFC-L9630CDN)<br/>36.5 kg</li> <li>• (MFC-L9635CDN)</li> </ul>                   |

|  |                       |                                   |   |  |
|--|-----------------------|-----------------------------------|---|--|
|  |                       |                                   | 36.8 kg<br>• (MFC-L9670CDN)<br>36.9 kg<br>• (MFC-EX670)<br>37.0 kg  |  |
| <b>Noise Level</b>                     | <b>Sound Pressure</b> | <b>Printing</b>                   | <b>1-sided printing</b><br>LpAm = 55 dB (A)<br><b>2-sided printing</b><br>LpAm = 56.5 dB (A)  |  |
|  |                       | <b>Printing (Quiet Mode)</b>      | <b>1-sided printing</b><br>LpAm = 52 dB (A)<br><b>2-sided printing</b><br>LpAm = 53 dB (A)  |  |
|  |                       | <b>Ready</b>                      | LpAm = 17.2 dB (A)  |  |
|  | <b>Sound Power</b>    | <b>Printing</b> <sup>5</sup>      | <b>Monochrome</b>   | LWAd = 6.79 B (A)  |
|  |                       |                                   | <b>Colour</b>   | LWAd = 6.78 B (A)  |
|  |                       | <b>Printing (Quiet Mode)</b>      | <b>Monochrome</b>   | <b>1-sided printing</b><br>LWAd = 6.37 B (A)<br><b>2-sided printing</b><br>LWAd = 6.68 B (A) |
|  |                       |                                   | <b>Colour</b>   | <b>1-sided printing</b><br>LWAd = 6.37 B (A)<br><b>2-sided printing</b><br>LWAd = 6.68 B (A) |
|  |                       | <b>Ready</b> <sup>5</sup>         | LWAd = 3.06 B(A)  |  |
| <b>Temperature</b>                     | <b>Operating</b>      | From 10°C to 32°C                 |   |  |
|  | <b>Storage</b>        | From 0°C to 40°C                  |   |  |
| <b>Humidity</b>                        | <b>Operating</b>      | 20% to 80% (without condensation) |   |  |
|  | <b>Storage</b>        | 10% to 90% (without condensation) |   |  |
| <b>Automatic Document Feeder (ADF)</b> |                       |                                   | Up to 100 sheets<br>For best results we recommend: <ul style="list-style-type: none"> <li>• Temperature: 20°C to 30°C</li> <li>• Humidity: 50% to 70%</li> <li>• Paper: 80 g/m<sup>2</sup></li> </ul> |  |

1 Measured diagonally.

2 USB connections to a computer.

3 Measured according to IEC 62301 Edition 2.0.

4 Power consumption varies slightly depending on the usage environment.

5 Measured in accordance with the method described in DE-UZ 205.

## Document Size Specification

|                      |                   |                      |
|----------------------|-------------------|----------------------|
| <b>Document Size</b> | <b>ADF Width</b>  | 105 mm to 215.9 mm   |
|                      | <b>ADF Length</b> | 147.3 mm to 355.6 mm |



|                      |                             |                  |
|----------------------|-----------------------------|------------------|
| <b>Document Size</b> | <b>Scanner Glass Width</b>  | Maximum 215.9 mm |
|                      | <b>Scanner Glass Length</b> | Maximum 355.6 mm |

## Print Media Specifications

|                                  |   |   |   |
|----------------------------------|---|---|---|
| <b>Paper Input</b>               | <b>Paper Tray (Standard)</b>                      | <b>Paper Type</b>   | Plain Paper, Letterhead, Coloured Paper, Thin Paper, Recycled Paper, Thick Paper, Thicker Paper   |
|                                  |   | <b>Paper Size</b>   | A4, Letter, B5 (JIS), B5 (ISO), A5, A5 (Long Edge), B6 (JIS), A6, Executive, Legal, Mexico Legal, India Legal, Folio, 16K (195x270 mm), A4 Short (270mm Paper)  |
|                                  |   | <b>Paper Weight</b>   | 60 to 230 g/m <sup>2</sup>  |
|                                  |   | <b>Maximum Paper Capacity</b>   | Up to 520 sheets of 80 g/m <sup>2</sup> Plain Paper   |
|                                  | <b>Multi-Purpose Tray (MP tray)</b>               | <b>Paper Type</b>   | Plain Paper, Letterhead, Coloured Paper, Thin Paper, Thick Paper, Thicker Paper, Recycled Paper, Bond, Label, Envelope, Env.Thin, Env.Thick, Glossy Paper   |
|                                  |   | <b>Paper Size</b>   | <ul style="list-style-type: none"> <li>Width: 76.2 to 215.9 mm</li> <li>Length: 127 to 355.6 mm</li> <li>Envelope: COM-10, DL, C5, Monarch</li> </ul>   |
|                                  |   | <b>Paper Weight</b>   | 60 to 230 g/m <sup>2</sup>  |
|                                  |   | <b>Maximum Paper Capacity</b>   | <ul style="list-style-type: none"> <li>Up to 100 Sheets of 80 g/m<sup>2</sup> Plain Paper</li> <li>Envelope: 15 envelopes</li> </ul>  |
|                                  | <b>Paper Tray 2, 3, 4 (Optional) <sup>1</sup></b> | <b>Paper Type</b>   | Plain Paper, Letterhead, Coloured Paper, Thin Paper, Recycled Paper   |
|                                  |   | <b>Paper Size</b>   | A4, Letter, B5 (JIS), A5, Executive, Legal, Mexico Legal, India Legal, Folio, 16K (195x270 mm), A4 Short (270mm Paper)  |
|                                  |   | <b>Paper Weight</b>   | 60 to 105 g/m <sup>2</sup>  |
|                                  |   | <b>Maximum Paper Capacity</b>   | <ul style="list-style-type: none"> <li>LT-330CL<br/>Up to 250 sheets of 80 g/m<sup>2</sup> Plain Paper</li> <li>LT-340CL<br/>Up to 500 sheets of 80 g/m<sup>2</sup> Plain Paper</li> </ul>                |
| <b>Paper Output <sup>2</sup></b> | <b>Face Down Output Tray</b>                      | Up to 250 Sheets of 80 g/m <sup>2</sup> Plain Paper (face down delivery to the face down output paper tray) |   |
|                                  | <b>Face Up Output Tray</b>                        | One sheet (face up delivery to the face up output tray)   |   |
| <b>2-sided</b>                   | <b>Automatic 2-sided Printing</b>                 | <b>Paper Type</b>   | Plain Paper, Letterhead, Coloured Paper, Thin Paper, Thick Paper, Thicker Paper, Recycled Paper, Glossy Paper   |
|                                  |   | <b>Paper Size</b>   | Select the paper size you want to use by sliding the 2-sided lever: <ul style="list-style-type: none"> <li>A4, A4 Short (270mm Paper)</li> <li>Letter, Legal, Mexico Legal, India Legal, Folio</li> </ul> |
|                                  |   | <b>Paper Weight</b>   | 60 to 230 g/m <sup>2</sup>  |

<sup>1</sup> Maximum number of Lower Trays: Up to three LT-330CL Lower Trays, or two LT-340CL, or a combination of one LT-330CL and one LT-340CL.

<sup>2</sup> For labels, we recommend removing the printed sheets from the output paper tray immediately after they exit the machine to avoid the possibility of smudging.

## Fax Specifications

|                                  |                                      |  |
|----------------------------------|--------------------------------------|--|
| <b>Compatibility</b>             | ITU-T Super Group 3                  |  |
| <b>Coding System</b>             | MH / MR / MMR / JBIG                 |  |
| <b>Modem Speed</b>               | 33,600 bps (with Automatic Fallback) |  |
| <b>2-sided Print Receiving</b>   | Yes                                  |  |
| <b>Automatic 2-sided Sending</b> | Yes (from the ADF)                   |  |
| <b>Scanning Width</b>            | Maximum 208 mm                       |  |
| <b>Printing Width</b>            | Maximum 208 mm                       |  |
| <b>Greyscale</b>                 | 8 bit / 256 levels                   |  |
| <b>Resolution</b>                | <b>Horizontal</b>                    | 203 dpi  |
|                                  | <b>Vertical</b>                      | Standard: 98 dpi<br>Fine: 196 dpi<br>Super fine: 392 dpi<br>Photo: 196 dpi |
| <b>Address Book</b>              | 300 Locations                        |  |
| <b>Groups</b>                    | Up to 20                             |  |
| <b>Broadcasting</b>              | 350 Locations                        |  |
| <b>Automatic Redial</b>          | 3 times at 5-minute intervals        |  |
| <b>Memory Transmission</b>       | Up to 500 pages <sup>1</sup>         |  |
| <b>Out of Paper Reception</b>    | Up to 500 pages <sup>1</sup>         |  |

<sup>1</sup> 'Pages' refers to the 'ITU-T Test Chart #1' (a typical business letter, Standard resolution, JBIG code).

## Copy Specification

|   |   |
|---|---|
| <b>Copy Width</b>                       | Maximum 210 mm  |
| <b>Automatic 2-sided Copy</b>           | Yes (from the ADF)  |
| <b>Sort Copy</b>                        | Yes   |
| <b>Stack Copy</b>                       | Up to 999 pages   |
| <b>Enlarge/Reduce</b>                   | 25 to 400% (in increments of 1%)                          |
| <b>Resolution</b>                       | Maximum 600 x 600 dpi                                     |
| <b>First Copy Out Time <sup>1</sup></b> | <b>Monochrome</b><br>Less than 12 seconds at 23°C / 230 V |
|   | <b>Colour</b><br>Less than 13 seconds at 23°C / 230 V     |

<sup>1</sup> From Ready Mode and standard tray.

## Scanner Specifications

|                        |   |
|------------------------|---|
| <b>Colour / Black</b>  | Yes / Yes                                     |
| <b>TWAIN Compliant</b> | Yes<br>(Windows 7 / Windows 8.1 / Windows 10) |
| <b>WIA Compliant</b>   | Yes<br>(Windows 7 / Windows 8.1 / Windows 10) |
| <b>Colour Depth</b>    | • 30 bit colour Processing (Input)            |

|                                   |  |
|-----------------------------------|--|
|                                   | <ul style="list-style-type: none"> <li>• 24 bit colour Processing (Output)</li> </ul>  |
| <b>Grey Scale</b>                 | <ul style="list-style-type: none"> <li>• 10 bit colour Processing (Input)</li> <li>• 8 bit colour Processing (Output)</li> </ul>   |
| <b>Resolution</b> <sup>1</sup>    | <ul style="list-style-type: none"> <li>• Up to 19200 x 19200 dpi (interpolated)</li> <li>• Up to 600 x 600 dpi (from the Scanner Glass)</li> <li>• Up to 600 x 600 dpi (from the ADF)</li> </ul> |
| <b>Scanning Width</b>             | Maximum 210 mm   |
| <b>Automatic 2-sided Scanning</b> | Yes (from the ADF)   |

<sup>1</sup> Maximum 600 × 600 dpi scanning with the WIA driver in Windows 7, Windows 8.1, and Windows 10 (resolution up to 19200 × 19200 dpi can be selected by using the scanner utility).

## Printer Specifications

|  |  |   |
|--|--|---|
| <b>Automatic 2-sided Print</b>             | Yes  |   |
| <b>Emulation</b>                           | PCL5e, PCL5c, PCL6 (PCL XL Class3.0), BR-Script3, PDF Version 1.7, XPS Version 1.0 |   |
| <b>Resolution</b>                          | 600 x 600 dpi, 2,400 dpi class (2400 x 600) quality                                |   |
| <b>Print Speed</b> <sup>1 2</sup>          | <b>1-sided Print</b> <sup>3</sup>  | <b>Monochrome</b><br>Up to 42 pages/minute (Letter size)<br>Up to 40 pages/minute (A4 size)   |
|  |  | <b>Colour</b><br>Up to 42 pages/minute (Letter size)<br>Up to 40 pages/minute (A4 size)   |
|  | <b>2-sided Print</b>   | <b>Monochrome</b> <ul style="list-style-type: none"> <li>• (MFC-L9630CDN/MFC-L9635CDN)<br/>Up to 29 sides/minute (Up to 14 sheets/minute) (Letter size)<br/>Up to 28 sides/minute (Up to 14 sheets/minute) (A4 size)</li> <li>• (MFC-L9670CDN/MFC-EX670)<br/>Up to 42 sides/minute (Up to 21 sheets/minute) (Letter size)<br/>Up to 40 sides/minute (Up to 20 sheets/minute) (A4 size)</li> </ul> |
|  |  | <b>Colour</b> <ul style="list-style-type: none"> <li>• (MFC-L9630CDN/MFC-L9635CDN)<br/>Up to 29 sides/minute (Up to 14 sheets/minute) (Letter size)<br/>Up to 28 sides/minute (Up to 14 sheets/minute) (A4 size)</li> <li>• (MFC-L9670CDN/MFC-EX670)<br/>Up to 42 sides/minute (Up to 21 sheets/minute) (Letter size)<br/>Up to 40 sides/minute (Up to 20 sheets/minute) (A4 size)</li> </ul>     |
| <b>First Print Time</b> <sup>4 5 6 7</sup> | <b>Monochrome</b><br>Less than 10 seconds at 23°C / 230 V                          |   |
|  | <b>Colour</b><br>Less than 10 seconds at 23°C / 230 V                              |   |

<sup>1</sup> The print speed may change depending on the type of document you print.

<sup>2</sup> The print speed may be slower when the machine is connected by wireless LAN.

<sup>3</sup> Measured in accordance with ISO/IEC 24734.

<sup>4</sup> Printing from Ready mode and standard tray.

<sup>5</sup> Length of time from when the machine is started until paper output is complete (except when the machine is turned on or when an error is fixed).

<sup>6</sup> May vary when calibration or registration is in progress.

<sup>7</sup> This applies when printing on A4- or Letter-size paper from the standard tray. However, the First Print Time could be longer depending on the paper size and the amount of print data.

## Interface Specifications

|                                  |   |
|----------------------------------|---|
| <b>USB</b> <sup>1 2</sup>        | Hi-Speed USB 2.0<br>Use a USB 2.0 interface cable that is no more than 2 metres long. |
| <b>LAN</b>                       | 10Base-T/100Base-TX/1000Base-T <sup>3</sup>   |
| <b>Wireless LAN</b> <sup>4</sup> | IEEE 802.11a/b/g/n (Infrastructure Mode)<br>IEEE 802.11a/g/n (Wi-Fi Direct®)          |
| <b>NFC</b> <sup>5</sup>          | Yes   |

- 1 Your machine has a USB 2.0 Hi-Speed interface. The machine can also be connected to a computer that has a USB 1.1 interface.
- 2 Third party USB hub devices are not supported.
- 3 Use a Category 5e (or greater) network cable.
- 4 The wireless network connection can be used only when the optional Wireless Module is installed.
- 5 When you connect an external IC card reader, use a HID class driver supported device.

## Direct Print Feature Specifications

|                      |  |
|----------------------|--|
| <b>Compatibility</b> | PDF version 1.7, JPEG, Exif+JPEG, PRN (created by the machine's own printer driver), TIFF (scanned by Brother models), XPS version 1.0 |
| <b>Interface</b>     | USB direct interface: Front x1, Rear x1  |

## Supported Protocols and Security Features

### Ethernet

10Base-T/100Base-TX/1000Base-T

### Wireless LAN (5GHz)

IEEE 802.11a/n (Infrastructure Mode), IEEE 802.11a/n (Wi-Fi Direct)

### Wireless LAN (2.4GHz)

IEEE 802.11b/g/n (Infrastructure Mode), IEEE 802.11g/n (Wi-Fi Direct)

### Protocols (IPv4)

ARP, RARP, BOOTP, DHCP, APIPA (Auto IP), WINS/NetBIOS name resolution, DNS Resolver, mDNS, LLMNR responder, LPR/LPD, Custom Raw Port/Port9100, POP3, SMTP Client, IPP/IPPS, FTP Client and Server, CIFS Client, TELNET Server, SNMPv1/v2c/v3, HTTP/HTTPS server, TFTP client and server, ICMP, Web Services (Print/Scan), SNTTP Client, LDAP, IMAP4

### Protocols (IPv6)

NDP, RA, DNS resolver, mDNS, LLMNR responder, LPR/LPD, Custom Raw Port/Port9100, IPP/IPPS, POP3, SMTP Client, FTP Client and Server, CIFS Client, TELNET Server, SNMPv1/v2c/v3, HTTP/HTTPS server, TFTP client and server, ICMPv6, SNTTP Client, LDAP, Web Services (Print/Scan), IMAP4

### Network Security (Wired)

APOP, SMTP-AUTH, SSL/TLS (IPPS, HTTPS, SMTP, POP3, IMAP4), SNMP v3, 802.1x (EAP-MD5, EAP-FAST, PEAP, EAP-TLS, EAP-TTLS), Kerberos, IPsec

### Network Security (Wireless)

APOP, SMTP-AUTH, SSL/TLS (IPPS, HTTPS, SMTP, POP3, IMAP4), SNMP v3, 802.1x (EAP-FAST, PEAP, EAP-TLS, EAP-TTLS), Kerberos, IPsec

### Wireless Network Security

WEP 64/128 bit, WPA-PSK (TKIP/AES), WPA2-PSK (TKIP/AES) (Wi-Fi Direct supports WPA2-PSK (AES) only)

## Wireless Certification

Wi-Fi Certification Mark License (WPA™/WPA2™ - Enterprise, Personal), Wi-Fi Protected Setup™ (WPS) Identifier Mark License, Wi-Fi CERTIFIED™ Wi-Fi Direct

## Computer Requirements Specifications

### Supported Operating Systems And Software Functions

| Computer Platform & Operating System Version |  | Computer Interface  |  |   |  | Processor | Hard Disk Space to Install |                                      |
|--|--|---------------------|--|---|--|-----------|----------------------------|--------------------------------------|
|  |  | Parallel (IEEE1284) | USB <sup>1</sup>                                     | 10Base-T/100Base-TX/1000Base-T (Ethernet) | Wireless <sup>2</sup><br>802.11a/b/g/n |           | For Drivers                | For Applications (including Drivers) |
| Windows Operating System                     | Windows 7 SP1 / 8.1 <sup>3 4 5</sup>                                   | N/A                 | Printing<br>PC Fax <sup>6</sup><br>Scanning          |   | 32 bit (x86) or 64 bit (x64) processor | 80 MB     | 1.8 GB                     |                                      |
|  | Windows 10 Home / 10 Pro / 10 Education / 10 Enterprise <sup>3 4</sup> |                     |  |   |  |           |                            |                                      |
|  | Windows Server 2008 SP2 <sup>5</sup>                                   | N/A                 | Printing<br>Scanning                                 | Printing                                  | 64 bit (x64) processor                 | 50 MB     | 50 MB                      |                                      |
|  | Windows Server 2008 R2 <sup>5</sup>                                    |                     |  |   |  |           |                            |                                      |
|  | Windows Server 2012  |                     |  |   |  |           |                            |                                      |
|  | Windows Server 2012 R2   |                     |  |   |  |           |                            |                                      |
|  | Windows Server 2016  |                     |  |   |  |           |                            |                                      |
|  | Windows Server 2019  |                     |  |   |  |           |                            |                                      |
| Mac Operating System <sup>7</sup>            | macOS v10.14.x   | N/A                 | Printing<br>PC-Fax (Send) <sup>6 8</sup><br>Scanning |   | 64 bit (x64) processor                 | N/A       | 500 MB                     |                                      |
|  | macOS v10.15.x   |                     |  |   |  |           |                            |                                      |
|  | macOS v11  |                     |  |   |  |           |                            |                                      |

<sup>1</sup> Third-party USB ports are not supported.

<sup>2</sup> For certain models, the optional Wireless Module is required.

<sup>3</sup> For WIA, 600x600 resolution. Brother Scanner Utility enables resolutions up to 19200 x 19200 dpi.

<sup>4</sup> PaperPort™ 14SE supports Windows 7 SP1, Windows 8.1 and Windows 10.

<sup>5</sup> Windows 7 / Server 2008 / Server 2008 R2 supported by Extended Security Updates until Jan 10, 2023.

<sup>6</sup> PC-Fax supports black and white only.

<sup>7</sup> macOS Disclaimer

AirPrint capable: Printing or scanning via Mac requires using AirPrint. Mac drivers are not provided.

<sup>8</sup> AirPrint only.

For the latest driver updates, go to your model's **Downloads** page at [support.brother.com](https://support.brother.com).

All trademarks, brand and product names are the property of their respective companies.



## Related Information

- [Appendix](#)
-

## Supplies

When the time comes to replace supplies, such as the toner cartridge or drum unit, an error message will appear on your machine's control panel or in the Status Monitor. For more information about the supplies for your machine, visit [www.brother.com/original](http://www.brother.com/original) or contact your local Brother dealer.

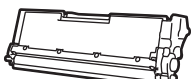
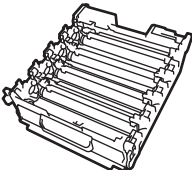

The Supply Model Name will vary depending on your country and region.

| Supply Items  | Supply Model Name                            | Approximate Life (Page Yield)  | Applicable Models                                    |
|---|--|--|--|
| <b>Toner Cartridge</b><br> | High Yield Toner:<br>TN821XL                 | <ul style="list-style-type: none"> <li>Black:<br/>Approximately 12,000 pages<sup>1 2</sup></li> <li>Cyan / Magenta / Yellow:<br/>Approximately 9,000 pages<sup>1 2</sup></li> </ul>  | MFC-L9630CDN/MFC-L9635CDN/<br>MFC-L9670CDN/MFC-EX670 |
|   | Super High Yield Toner:<br>TN821XXL          | <ul style="list-style-type: none"> <li>Black:<br/>Approximately 15,000 pages<sup>1 2</sup></li> <li>Cyan / Magenta / Yellow:<br/>Approximately 12,000 pages<sup>1 2</sup></li> </ul> | MFC-L9630CDN/MFC-L9635CDN/<br>MFC-L9670CDN/MFC-EX670 |
|   | Inbox Toner:<br>(Supplied with your machine) | <ul style="list-style-type: none"> <li>Black:<br/>Approximately 9,000 pages<sup>1 2</sup></li> <li>Cyan / Magenta / Yellow:<br/>Approximately 6,500 pages<sup>1 2</sup></li> </ul>   | MFC-L9630CDN   |
|   |  | <ul style="list-style-type: none"> <li>Black:<br/>Approximately 12,000 pages<sup>1 2</sup></li> <li>Cyan / Magenta / Yellow:<br/>Approximately 9,000 pages<sup>1 2</sup></li> </ul>  | MFC-L9670CDN   |
|   |  | <ul style="list-style-type: none"> <li>Black:<br/>Approximately 15,000 pages<sup>1 2</sup></li> <li>Cyan / Magenta / Yellow:<br/>Approximately 12,000 pages<sup>1 2</sup></li> </ul> | MFC-L9635CDN/MFC-EX670                               |
| <b>Drum Unit</b><br>     | DR821CL                                      | Approximately 100,000 pages <sup>3</sup>   | MFC-L9630CDN/MFC-L9635CDN/<br>MFC-L9670CDN/MFC-EX670 |

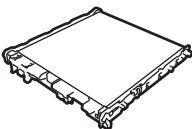
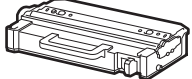
| Supply Items  | Supply Model Name | Approximate Life (Page Yield)                | Applicable Models                                    |
|---|-------------------|--|--|
| <b>Belt Unit</b><br>       | BU800CL           | Approximately 150,000 pages <sup>4</sup>     | MFC-L9630CDN/MFC-L9635CDN/<br>MFC-L9670CDN/MFC-EX670 |
| <b>Waste Toner Box</b><br> | WT800CL           | Approximately 100,000 pages <sup>2 5 6</sup> | MFC-L9630CDN/MFC-L9635CDN/<br>MFC-L9670CDN/MFC-EX670 |

<sup>1</sup> The approximate cartridge yield is declared in accordance with ISO/IEC 19798.

<sup>2</sup> A4 or Letter size single-sided pages

<sup>3</sup> Approximately 100,000 pages based on 3 pages per job [A4/Letter single-sided pages]. The number of pages may be affected by a variety of factors including but not limited to media type and media size.

<sup>4</sup> Approximately 150,000 pages based on 2 pages per job [A4/Letter single-sided pages]. The number of pages may be affected due to a variety of factors including but not limited to media type and media size.

<sup>5</sup> Approximate waste toner box yield is declared in accordance with ISO/IEC 19798.

<sup>6</sup> The number of pages may be affected due to a variety of factors including but not limited to media type and media size.



## Related Information

- [Appendix](#)



## Important Information About Toner Cartridge Life

### Toner Cartridge Life

This product detects the life of the toner cartridges using the following two methods:

- Detection by counting the dots of each colour that are necessary to create an image
- Detection by counting the rotations of the developer roller

The print operation will stop when either of the upper limits is reached. The upper limit is set above the number of dots or rotations that would be required for the cartridge to perform consistently with its advertised page yield. This function is intended to reduce the risk of poor print quality and damage to the machine.

There are two messages that indicate when the toner is low or needs replacing: Toner Low and Replace Toner.

Toner Low is displayed on the LCD when the number of dots or rotations of the developer roller nears its maximum count. Replace Toner is displayed on the LCD when the number of dots or rotations of the developer roller reaches its maximum count.

### Colour Correction

The number of developer roller rotations that is counted may not only be for normal operations, such as printing and copying, but also for machine adjustments, such as Colour Calibration and Colour Registration.

#### Colour Calibration (Adjustment of Colour Density)

To obtain stable print quality, the density of each toner cartridge needs to be maintained at a fixed value. If the density balance between the colours cannot be kept, the tint becomes unstable, and accurate colour reproduction becomes impossible. The toner density can change due to chemical changes to the toner that affect its electrical charge, deterioration of the developer unit, and temperature and humidity levels in the machine. During calibration, the density level adjustment test patterns are printed on the belt unit.

Calibration is mainly performed at the following times:

- When you start the Colour Correction from the control panel or the printer driver to improve the colour density.
- When you replace a used toner cartridge or drum unit with a new one.
- When the machine detects that the ambient temperature and humidity have changed.
- When a specified number of printed pages is reached.

#### Colour Registration (Correction of Colour Position)

In this machine, the drum unit and developer unit are prepared for black (K), yellow (Y), magenta (M), and cyan (C), respectively. Four colour images are combined into one image, and therefore colour registration errors (for example, how the four colour images align) may occur. When registration errors occur, registration correction test patterns are printed on the belt unit.

Registration is mainly performed at the following times:

- When you start the Colour Correction to clear the colour registration error.
- When a specified number of printed pages is reached.



### Related Information

- [Appendix](#)

## **Environmental and Compliance Information**

- [Information Regarding Recycled Paper](#)
- [Availability of Service Parts](#)
- [Chemical Substances \(EU REACH\)](#)

## Information Regarding Recycled Paper

- Recycled paper is of the same quality as paper made from original forest sources. Standards governing modern recycled paper ensure that it meets the highest quality requirements for different printing processes. The imaging equipment supplied by Brother is suitable for using with recycled paper meeting the EN 12281:2002 standard.
- Purchasing recycled paper saves natural resources and promotes the circular economy. Paper is made using cellulose fibres from wood. Collecting and recycling paper extends the life of fibres over multiple life cycles, making the best use of the resources.
- The recycled paper production process is shorter. The fibres have already been processed, so less water and energy, and fewer chemicals are used.
- Paper recycling has the benefit of saving carbon by diverting paper products from alternative disposal routes such as landfill and incineration. Landfill waste emits methane gas, which has a powerful greenhouse effect.



### Related Information

- [Environmental and Compliance Information](#)
-

## Availability of Service Parts

Brother warrants that service parts will be available for at least seven years after the end of placing the models on the market.

To obtain service parts, contact your Brother supplier or dealer.



### Related Information

- [Environmental and Compliance Information](#)
-

## Chemical Substances (EU REACH)

Information concerning chemical substances within our products required for the REACH Regulation can be found at <https://www.brother.eu/reach>.



### Related Information

- [Environmental and Compliance Information](#)
-

## Accessories

Availability of accessories may vary depending on your country or region. For more information about the accessories for your machine, visit [www.brother.com/original](http://www.brother.com/original) or contact your Brother dealer or Brother customer service.

| Model name   | Items                   | Applicable Models   |
|--|-------------------------|---|
| LT-330CL   | Lower Tray (250 sheets) | MFC-L9630CDN/MFC-L9635CDN/MFC-L9670CDN/<br>MFC-EX670 <sup>1</sup> |
| LT-340CL   | Lower Tray (500 sheets) | MFC-L9630CDN/MFC-L9635CDN/MFC-L9670CDN/<br>MFC-EX670 <sup>1</sup> |
| NC-9000w<br>(Available only for<br>some countries) | Wireless Module         | MFC-L9630CDN/MFC-L9635CDN/MFC-L9670CDN/<br>MFC-EX670              |

<sup>1</sup> Maximum number of Lower Trays: Up to three LT-330CL Lower Trays, or two LT-340CL, or a combination of one LT-330CL and one LT-340CL.



### Related Information

- [Appendix](#)

## Brother Help and Customer Support

If you need help with using your Brother product, visit [support.brother.com](http://support.brother.com) for FAQs and troubleshooting tips. You can also download the latest software, drivers and firmware, to improve the performance of your machine, and user documentation, to learn how to get the most from your Brother product.

Further product and support information is available from your local Brother office website. Visit [www.brother.com](http://www.brother.com) to find the contact details for your local Brother office and to register your new product.



### Related Information

- [Appendix](#)
-

brother



UK  
Version A