



# Online User's Guide

**HL-L2400D**

**HL-L2405W**

**HL-L2420DW**

**HL-L2460DW**

**HL-L2460DWXL**

**HL-L2865DW**

## Table of Contents

<b>Before You Use Your Machine</b> .....	<b>1</b>
Definitions of Notes .....	2
Notice - Disclaimer of Warranties (USA and Canada) .....	3
Trademarks .....	4
Open Source Licensing .....	5
Copyright and License .....	6
Important Notes.....	7
<b>Introduction to Your Machine</b> .....	<b>8</b>
Before Using Your Machine .....	9
Front View and Back View .....	10
Control Panel Overview .....	11
LED Patterns and Indications (for Models Without an LCD).....	14
How to Enter Text on Your Machine .....	16
Access Brother Utilities (Windows) .....	17
Uninstall the Software and Drivers (Windows).....	19
Access Brother iPrint&Scan (Windows/Mac) .....	20
Input/Output Port Locations on Your Machine .....	21
<b>Paper Handling</b> .....	<b>22</b>
Load Paper.....	23
Load Paper in the Paper Tray .....	24
Load and Print Plain Paper, Thin Paper, Recycled Paper and Bond Paper in the Manual Feed Slot .....	27
Load and Print on Thick Paper and Labels Using the Manual Feed Slot.....	28
Load and Print on Envelopes in the Manual Feed Slot .....	30
Paper Settings.....	32
Change the Paper Size and Paper Type.....	33
Change the Check Paper Setting .....	34
Unprintable Area .....	35
Recommended Print Media .....	36
Using Special Paper.....	37
<b>Print</b> .....	<b>38</b>
Print from Your Computer (Windows).....	39
Print a Document (Windows).....	40
Print on Both Sides of the Paper (Windows) .....	42
Change the Default Print Settings (Windows) .....	45
Print Settings (Windows) .....	46
Monitor the Status of the Machine from Your Computer (Windows) .....	50
Print from Your Computer (Mac) .....	51
Load and Print on Envelopes in the Manual Feed Slot.....	52
Print an Email Attachment.....	54
Change Print Settings Using the Control Panel .....	55
Cancel a Print Job.....	56
Test Print .....	57
<b>Network</b> .....	<b>58</b>
Supported Basic Network Features .....	59

Configure Network Settings .....	60
Configure Network Details Using the Control Panel.....	61
Wireless Network Settings .....	62
Use the Wireless Network .....	63
Use Wi-Fi Direct® .....	77
Enable/Disable Wireless LAN .....	81
Print the WLAN Report.....	82
Network Features.....	86
Enable/Disable Web Based Management Using the Control Panel.....	87
Print the Network Configuration Report.....	88
Reset the Network Settings to the Factory Settings.....	89
<b>Security .....</b>	<b>90</b>
Before Using Network Security Features .....	91
Disable Unnecessary Protocols .....	92
Configure Certificates for Device Security .....	93
Supported Security Certificate Features .....	94
How to Create and Install a Certificate .....	95
Create a Self-signed Certificate .....	96
Create a Certificate Signing Request (CSR) and Install a Certificate from a Certificate Authority (CA) .....	97
Import and Export the Certificate and Private Key .....	101
Import and Export a CA Certificate.....	104
Manage Multiple Certificates .....	107
Use SSL/TLS .....	108
Introduction to SSL/TLS .....	109
Manage Your Network Machine Securely Using SSL/TLS.....	112
Print Documents Securely Using SSL/TLS .....	116
Use SNMPv3.....	118
Manage Your Network Machine Securely Using SNMPv3 .....	119
Use IEEE 802.1x Authentication .....	120
What Is IEEE 802.1x Authentication? .....	121
Configure IEEE 802.1x Authentication for a Wired or Wireless Network Using Web Based Management (Web Browser).....	122
IEEE 802.1x Authentication Methods.....	124
Send an Email Securely.....	125
Configure Email Sending Using Web Based Management.....	126
Send an Email with User Authentication .....	127
Send an Email Securely Using SSL/TLS .....	128
Lock the Machine Settings from the Control Panel.....	129
Setting Lock Overview.....	130
Use Global Network Detection Features.....	134
Enable Global IP Address Detection .....	135
Block Communications from the Global Network .....	136
<b>Mobile Connect .....</b>	<b>137</b>
AirPrint .....	138
AirPrint Overview.....	139
Before Using AirPrint (macOS) .....	140

Print Using AirPrint .....	141
Mopria™ Print Service .....	144
Brother Mobile Connect .....	145
<b>Troubleshooting .....</b>	<b>146</b>
Error and Maintenance LED Indications .....	147
Error and Maintenance Messages .....	152
Paper Jams .....	156
Clear Paper Jams .....	157
Paper is Jammed in the Paper Tray .....	158
Paper is Jammed in the Back of the Machine .....	159
Paper is Jammed inside the Machine .....	161
Paper is Jammed in the 2-sided Tray .....	162
Printing Problems .....	165
Improve the Print Quality .....	168
Network Problems .....	173
Error Messages .....	174
Use the Network Connection Repair Tool (Windows) .....	175
Check Your Machine's Network Settings .....	176
If You Are Having Difficulty with Your Machine's Network .....	177
AirPrint Problems .....	183
Other Problems .....	184
Check the Machine Information .....	185
Update Your Machine's Firmware .....	186
Reset Functions .....	187
Machine Reset .....	188
Network Reset .....	189
Factory Reset .....	190
<b>Routine Maintenance .....</b>	<b>191</b>
Replace Supplies .....	192
Replace the Toner Cartridge .....	194
Replace the Drum Unit .....	197
Reset the Drum Counter .....	199
Clean the Machine .....	200
Clean the Corona Wire .....	202
Clean the Drum Unit .....	203
Clean the Paper Pick-up Rollers .....	208
Check the Remaining Part Life .....	209
Pack and Ship Your Machine .....	210
<b>Machine Settings .....</b>	<b>212</b>
Check Your Machine's Password .....	213
Change Machine Settings from the Control Panel .....	214
General Settings .....	215
Menu Table (for LCD Models) .....	223
Print a List of Printer Settings .....	233
Change Machine Settings from Windows Printer Driver .....	234
Change Machine Settings Using Web Based Management .....	235
What is Web Based Management? .....	236







Access Web Based Management .....	237
Change the Login Password Using Web Based Management .....	240
<b>Appendix.....</b>	<b>241</b>
Specifications .....	242
Supplies .....	247
Brother Help and Customer Support.....	249

## Before You Use Your Machine

- [Definitions of Notes](#)
- [Notice - Disclaimer of Warranties \(USA and Canada\)](#)
- [Trademarks](#)
- [Open Source Licensing](#)
- [Copyright and License](#)
- [Important Notes](#)

## Definitions of Notes

We use the following symbols and conventions throughout this User's Guide:

 <b>WARNING</b>	WARNING indicates a potentially hazardous situation which, if not avoided, could result in death or serious injuries.
 <b>CAUTION</b>	CAUTION indicates a potentially hazardous situation which, if not avoided, may result in minor or moderate injuries.
<b>IMPORTANT</b>	IMPORTANT indicates a potentially hazardous situation which, if not avoided, may result in damage to property or loss of product functionality.
<b>NOTE</b>	NOTE specifies the operating environment, conditions for installation, or special conditions of use.
	Tips icons indicate helpful hints and supplementary information.
	Electrical Hazard icons alert you to possible electrical shock.
	Fire Hazard icons alert you to the possibility of a fire.
	Hot Surface icons warn you not to touch hot machine parts.
	Prohibition icons indicate actions you must not perform.
<b>Bold</b>	Bold style identifies buttons on the machine's control panel or computer screen.
<i>Italics</i>	Italicized style emphasizes an important point or refers you to a related topic.
Courier New	Courier New font identifies messages shown on the machine's LCD.

### ✓ Related Information

- [Before You Use Your Machine](#)

## Notice - Disclaimer of Warranties (USA and Canada)

BROTHER'S LICENSOR(S), AND THEIR DIRECTORS, OFFICERS, EMPLOYEES OR AGENTS (COLLECTIVELY BROTHER'S LICENSOR) MAKE NO WARRANTIES, EXPRESS OR IMPLIED, INCLUDING WITHOUT LIMITATION THE IMPLIED WARRANTIES OF MERCHANTABILITY AND FITNESS FOR A PARTICULAR PURPOSE, REGARDING THE SOFTWARE. BROTHER'S LICENSOR(S) DOES NOT WARRANT, GUARANTEE OR MAKE ANY REPRESENTATIONS REGARDING THE USE OR THE RESULTS OF THE USE OF THE SOFTWARE IN TERMS OF ITS CORRECTNESS, ACCURACY, RELIABILITY, CURRENTNESS OR OTHERWISE. THE ENTIRE RISK AS TO THE RESULTS AND PERFORMANCE OF THE SOFTWARE IS ASSUMED BY YOU. THE EXCLUSION OF IMPLIED WARRANTIES IS NOT PERMITTED BY SOME STATES IN THE USA AND SOME PROVINCES IN CANADA. THE ABOVE EXCLUSION MAY NOT APPLY TO YOU.

IN NO EVENT WILL BROTHER'S LICENSOR(S) BE LIABLE TO YOU FOR ANY CONSEQUENTIAL, INCIDENTAL, OR INDIRECT DAMAGES (INCLUDING DAMAGES FOR LOSS OF BUSINESS PROFITS, BUSINESS INTERRUPTION, LOSS OF BUSINESS INFORMATION, AND THE LIKE) ARISING OUT OF THE USE OR INABILITY TO USE THE SOFTWARE EVEN IF BROTHER'S LICENSOR HAS BEEN ADVISED OF THE POSSIBILITY OF SUCH DAMAGES. BECAUSE SOME STATES IN THE USA AND SOME PROVINCES IN CANADA DO NOT ALLOW THE EXCLUSION OR LIMITATION OF LIABILITY FOR CONSEQUENTIAL OR INCIDENTAL DAMAGES, THE ABOVE LIMITATIONS MAY NOT APPLY TO YOU. IN ANY EVENT BROTHER'S LICENSOR'S LIABILITY TO YOU FOR ACTUAL DAMAGES FROM ANY CAUSE WHATSOEVER, AND REGARDLESS OF THE FORM OF THE ACTION (WHETHER IN CONTRACT, TORT (INCLUDING NEGLIGENCE), PRODUCT LIABILITY OR OTHERWISE), WILL BE LIMITED TO \$50.



### Related Information

- [Before You Use Your Machine](#)



## Trademarks

Apple, App Store, AirPrint, the AirPrint logo, Mac, macOS, iPadOS, iPad, iPhone, iPod touch, and Safari are trademarks of Apple Inc., registered in the U.S. and other countries.

Adobe® and Reader® are either registered trademarks or trademarks of Adobe Systems Incorporated in the United States and/or other countries.

Wi-Fi®, Wi-Fi Alliance®, and Wi-Fi Direct® are registered trademarks of Wi-Fi Alliance®.

WPA™, WPA2™, WPA3™, Wi-Fi CERTIFIED, and Wi-Fi Protected Setup are trademarks of Wi-Fi Alliance®.

Android, Google Drive and Google Play are trademarks of Google LLC. Use of these trademarks is subject to Google Permissions.

Mopria™ and the Mopria™ Logo are registered and/or unregistered trademarks and service marks of Mopria Alliance, Inc. in the United States and other countries. Unauthorized use is strictly prohibited.

The Bluetooth® word mark is a registered trademark owned by Bluetooth SIG, Inc. and any use of such marks by Brother Industries, Ltd. is under license. Other trademarks and trade names are those of their respective owners.

Each company whose software title is mentioned in this manual has a Software License Agreement specific to its proprietary programs.

### Software Trademarks

FlashFX® is a registered trademark of Datalight, Inc.

FlashFX® Pro™ is a trademark of Datalight, Inc.

FlashFX® Tera™ is a trademark of Datalight, Inc.

Reliance™ is a trademark of Datalight, Inc.

Reliance Nitro™ is a trademark of Datalight, Inc.

Datalight® is a registered trademark of Datalight, Inc.

**Any trade names and product names of companies appearing on Brother products, related documents and any other materials are all trademarks or registered trademarks of those respective companies.**



### Related Information

- [Before You Use Your Machine](#)

## Open Source Licensing

This product includes open source software.

To view Open Source Licensing Remarks and Copyright Information, go to your model's **Manuals** page at [support.brother.com/manuals](http://support.brother.com/manuals).



### Related Information

- [Before You Use Your Machine](#)
-

## Copyright and License

©2023 Brother Industries, Ltd. All rights reserved.

This product includes software developed by the following vendors:

This product includes the "KASAGO TCP/IP" software developed by ZUKEN ELMIC, Inc.

Copyright 1989-2020 Datalight, Inc., All Rights Reserved.

FlashFX® Copyright 1998-2020 Datalight, Inc.



### Related Information

- [Before You Use Your Machine](#)

## Important Notes

- Check [support.brother.com/downloads](https://support.brother.com/downloads) for Brother driver and software updates.
- To keep your machine performance up to date, check [support.brother.com/downloads](https://support.brother.com/downloads) for the latest firmware upgrade. Otherwise, some of your machine's functions may not be available.
- Do not use this product outside the country of purchase as it may violate the wireless telecommunication and power regulations of that country.
- Not all models are available in all countries.
- Before giving your machine to anyone else, replacing it, or disposing of it, we strongly recommend resetting it to its factory settings to remove all personal information.
- Windows 10 in this document represents Windows 10 Home, Windows 10 Pro, Windows 10 Education, and Windows 10 Enterprise.
- Windows 11 in this document represents Windows 11 Home, Windows 11 Pro, Windows 11 Education, and Windows 11 Enterprise.
- In this User's Guide, the LCD messages of the HL-L2460DW are used unless otherwise specified.
- In this User's Guide, the illustrations of the HL-L2460DW are used unless otherwise specified.
- The screens or images in this User's Guide are for illustration purposes only and may differ from those of the actual products.
- Unless otherwise specified, the screens in this manual are from Windows 10. Screens on your computer may vary depending on your operating system.
- The contents of this document and the specifications of this product are subject to change without notice.
- Not all features are available in countries subject to applicable export restrictions.



### Related Information

- [Before You Use Your Machine](#)

## Introduction to Your Machine

- [Before Using Your Machine](#)
- [Front View and Back View](#)
- [Control Panel Overview](#)
- [LED Patterns and Indications \(for Models Without an LCD\)](#)
- [How to Enter Text on Your Machine](#)
- [Access Brother Utilities \(Windows\)](#)
- [Access Brother iPrint&Scan \(Windows/Mac\)](#)
- [Input/Output Port Locations on Your Machine](#)

## Before Using Your Machine

Before attempting any printing operation, confirm the following:

- Make sure you have installed the correct software and drivers for your machine.
- For USB or network cable users: Make sure the interface cable is physically secure.

### Firewall (Windows)

If your computer is protected by a firewall and you are unable to network print, you may need to configure the firewall settings. If you are using the Windows Firewall and you installed the drivers using the steps in the installer, the necessary firewall settings have been already set. If you are using any other personal firewall software, see the User's Guide for your software or contact the software manufacturer.



### Related Information

- [Introduction to Your Machine](#)
-

## Front View and Back View

### Front View

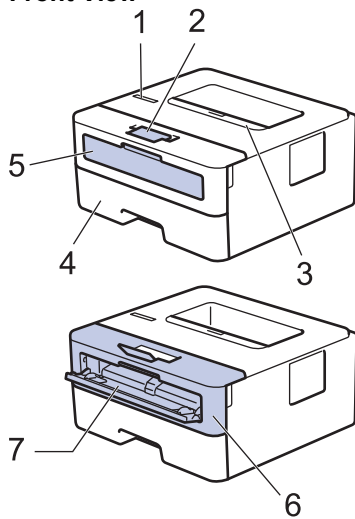

### Back View

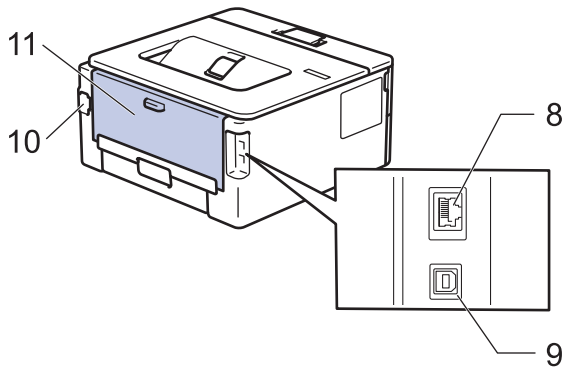

1. Control panel
2. Face-down output tray support flap
3. Face-down output tray
4. Paper tray
5. Manual feed slot cover
6. Front cover
7. Manual feed slot
8. (For wired network models)  
10BASE-T / 100BASE-TX port
9. USB port
10. AC power connector
11. Back cover (Face-up output tray)



The machine is equipped with a non-detachable AC power cord depending on the model.



### Related Information

- [Introduction to Your Machine](#)

## Control Panel Overview



>> HL-L2400D

>> HL-L2405W/HL-L2420DW/HL-L2460DW/HL-L2460DWXL/HL-L2865DW

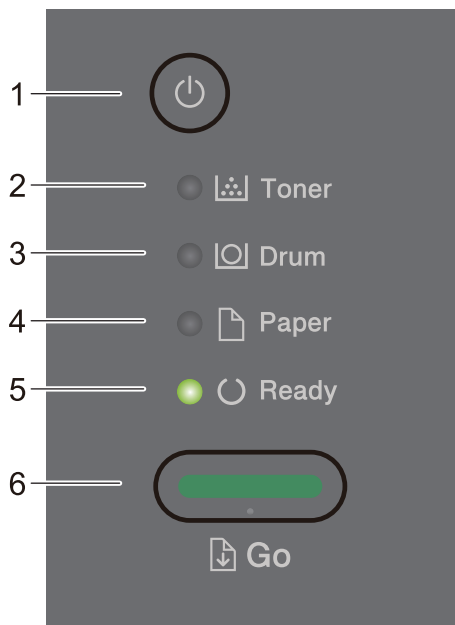
### HL-L2400D



#### 1. Power On/Off

- Turn on the machine by pressing .
- Turn off the machine by pressing and holding .

#### 2. Toner LED

The **Toner** LED indicates that the Toner is low.

#### 3. Drum LED

The **Drum** LED indicates that the Drum Unit must be replaced soon.

#### 4. Paper LED

The **Paper** LED indicates that there is an error relating to paper feeding.

#### 5. Ready LED

The **Ready** LED blinks to indicate the machine's status.

#### 6. Go Button

- Press **Go** to clear certain errors.
- Press **Go** to print any data remaining in the machine's memory.
- Press and hold **Go** for about two seconds to cancel a print job.

### HL-L2405W/HL-L2420DW/HL-L2460DW/HL-L2460DWXL/HL-L2865DW

The control panel will vary depending on your model.





### 1. Liquid Crystal Display (LCD)



Displays messages to help you set up and use your machine.

Wireless Models:

A four-level indicator shows the wireless signal strength if you are using a wireless connection.



### 2. Power On/Off

- Turn on the machine by pressing .
- Turn off the machine by pressing and holding . The LCD displays [Shutting Down] for a few seconds before turning off.

### 3. Network Buttons

- Models with Wireless Network:

#### Wi-Fi

Press and hold the **Wi-Fi** button and launch the wireless installer on your computer. Follow the on-screen instructions to set up a wireless connection between your machine and your network.

When the **Wi-Fi** light is on, your Brother machine is connected to a wireless access point. When the **Wi-Fi** light blinks, the wireless connection is down, or your machine is in the process of connecting to a wireless access point.

- Model with Wired Network only:

#### Network

Press **Network** to set up wired network settings.

- Models without Network Function:

#### Report

Press **Report** to print the Printer Settings.

### 4. Menu Buttons

#### OK

Press to store your machine settings. After you change a setting, the machine returns to the previous menu level.

#### Back

- Press to go back one level in the menu.

- 
- Press to select the previous digit when entering numbers.

#### **▲ or ▼ ( + or -)**

- Press to scroll through menus and options.
- Press to enter a number or to increase or decrease the number. Press and hold down ▲ or ▼ to scroll faster. When you see the number you want, press **OK**.

#### **5. Go Button**

- Press to clear certain error messages. To clear all other errors, follow the control panel instructions.
- Press to print any data remaining in the machine's memory.
- Press to select the displayed option. After you change a setting, the machine returns to Ready mode.
- Press and hold **Go** for about two seconds to cancel a print job.



#### **Related Information**



- [Introduction to Your Machine](#)
-

## LED Patterns and Indications (for Models Without an LCD)





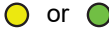

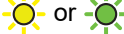





**Related Models:** HL-L2400D

The LEDs on your machine's control panel light up, dim, or blink to indicate machine status.





**LED indications are defined in the table below.**

	LED is off.
	LED is on.
	LED is dimmed.
	LED is blinking.

**This table defines what LEDs indicate when they light up, dim, or blink.**

LED indication	Status	Meaning
<ul style="list-style-type: none"> <li> Toner</li> <li> Drum</li> <li> Paper</li> <li> Ready</li> </ul>	Sleep	In Sleep mode (Power Save mode), the machine acts as if it is turned off, but it can still receive data. Receiving a print job will wake the machine and it will start printing.
<ul style="list-style-type: none"> <li> Toner</li> <li> Drum</li> <li> Paper</li> <li> Ready</li> </ul>	Ready	The machine is ready to print.
<ul style="list-style-type: none"> <li> Toner</li> <li> Drum</li> <li> Paper</li> <li> Ready</li> </ul>	Please Wait	The machine is warming up.
	Printing	The machine is printing.
	Cooling Down	The machine is cooling down. Wait for 10 minutes or until the inside of the machine has cooled down.

---

LED indication	Status	Meaning
<p> Toner</p> <p> Drum</p> <p> Paper</p> <p> Ready</p>	Cancel Printing	The machine is canceling the job.



### Related Information

- [Introduction to Your Machine](#)
-

## How to Enter Text on Your Machine

**Related Models:** HL-L2405W/HL-L2420DW/HL-L2460DW/HL-L2460DWXL/HL-L2865DW

When text is required, enter characters on the machine. The characters that are available may differ depending on the operation you perform.

- Hold down or repeatedly press ▲ or ▼ to select a character from this list:  
0123456789abcdefghijklmnopqrstuvwxyzABCDEFGHIJKLMNOPQRSTUVWXYZ(space)!"#\$%&'()\*+,-./:;<=>?  
@[^\_`{|}~
- Press **OK** when the character or symbol you want is displayed, and then enter the next character.
- Press **Back** to delete characters entered incorrectly.



### Related Information

- [Introduction to Your Machine](#)

#### Related Topics:

- [Configure Your Machine for a Wireless Network Using the Machine's Control Panel Setup Wizard](#)
- [Configure Your Machine for a Wireless Network When the SSID Is Not Broadcast](#)
- [Set the Setting Lock Password](#)

## Access Brother Utilities (Windows)

**Brother Utilities** is an application launcher that offers convenient access to all Brother applications installed on your computer.

1. Do one of the following:

- (Windows 11)

Click  > **All apps** > **Brother** > **Brother Utilities**.

- (Windows 10, Windows Server 2016, Windows Server 2019, and Windows Server 2022)

Click  > **Brother** > **Brother Utilities**.

- (Windows Server 2012 R2)

Move your mouse to the lower left corner of the **Start** screen and click  (if you are using a touch-based device, swipe up from the bottom of the **Start** screen to bring up the **Apps** screen).

When the **Apps** screen appears, tap or click  (**Brother Utilities**).

- (Windows Server 2012)

Tap or click  (**Brother Utilities**) either on the **Start** screen or the desktop.

2. Select your machine.

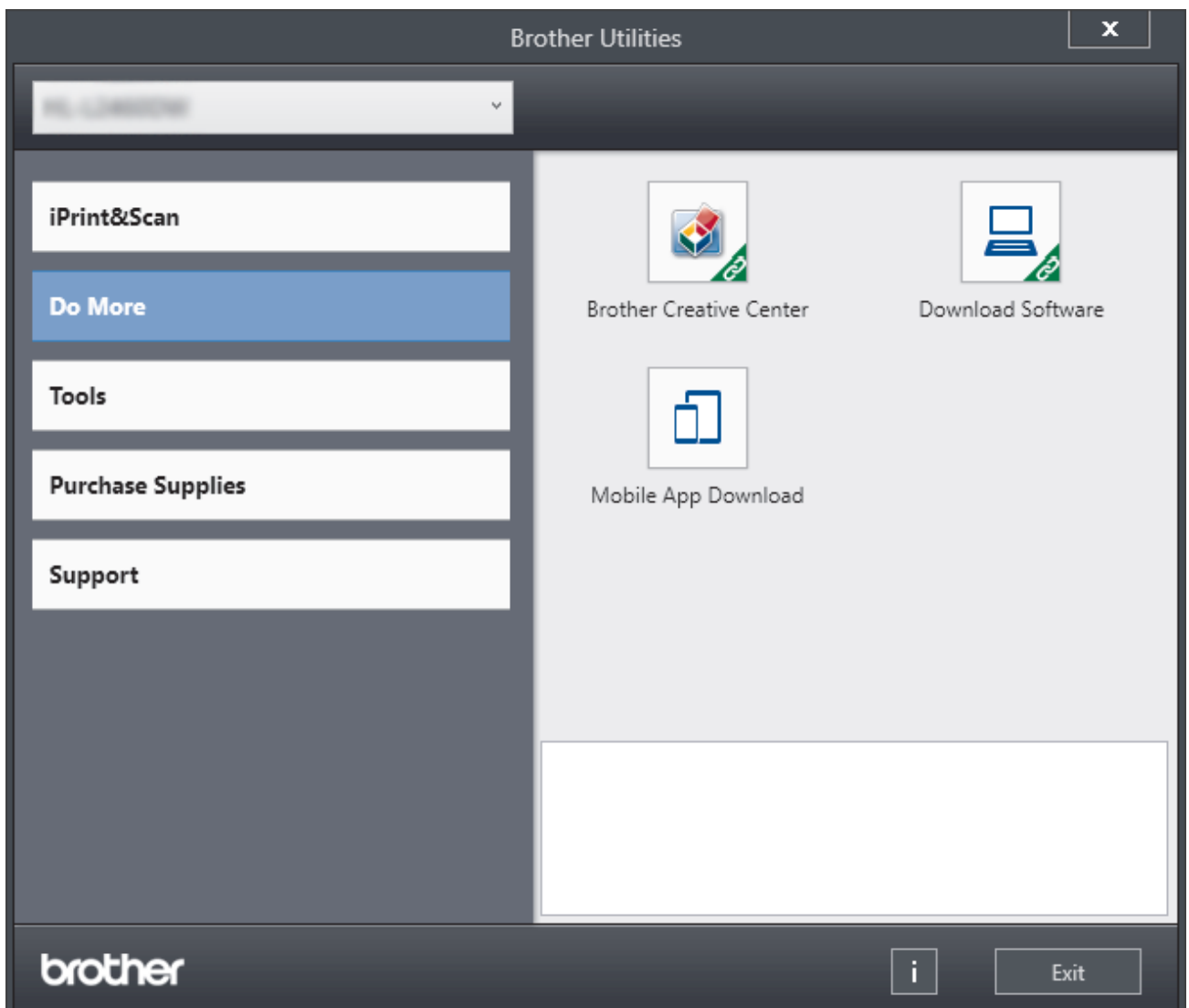

3. Choose the option you want.



## Related Information

- [Introduction to Your Machine](#)
  - [Uninstall the Software and Drivers \(Windows\)](#)
-

## Uninstall the Software and Drivers (Windows)

1. Do one of the following:

- Windows 11

Click  > **All apps** > **Brother** > **Brother Utilities**.

- Windows 10, Windows Server 2016, Windows Server 2019, and Windows Server 2022

Click  > **Brother** > **Brother Utilities**.

- Windows Server 2012 R2

Move your mouse to the lower left corner of the **Start** screen and click  (if you are using a touch-based device, swipe up from the bottom of the **Start** screen to bring up the **Apps** screen).

When the **Apps** screen appears, tap or click  (**Brother Utilities**).

- Windows Server 2012

Tap or click  (**Brother Utilities**) either on the **Start** screen or the desktop.

2. Select your model from the drop-down list (if it is not already selected).

3. Click **Tools** in the left navigation bar.

- If the **Software Update Notification** icon is visible, select it, and then click **Check now** > **Check for Software Updates** > **Update**. Follow the on-screen instructions.
- If the **Software Update Notification** icon is not visible, go to the next step.

4. Click **Uninstall** in the **Tools** section of **Brother Utilities**.

Follow the instructions in the dialog box to uninstall the software and drivers.



### Related Information

- [Access Brother Utilities \(Windows\)](#)





## Access Brother iPrint&Scan (Windows/Mac)

Use Brother iPrint&Scan for Windows and Mac to print from your computer.

- This function is not available in countries subject to applicable export regulations.
  - **To download the latest version:**
    - For Windows:  
Go to your model's **Downloads** page at [support.brother.com/downloads](https://support.brother.com/downloads), and then download and install Brother iPrint&Scan.
    - For Mac: (HL-L2405W/HL-L2420DW/HL-L2460DW/HL-L2460DWXL/HL-L2865DW)  
Download and install Brother iPrint&Scan from the Apple App Store.
- If prompted, install the driver and software necessary to use your machine. Download your machine's latest driver and software from your model's **Downloads** page at [support.brother.com/downloads](https://support.brother.com/downloads).

1. Do one of the following:

- Windows 11  
Click  > **All apps** > **Brother** > **Brother iPrint&Scan**.
- Windows 10  
Click  > **Brother** > **Brother iPrint&Scan**.

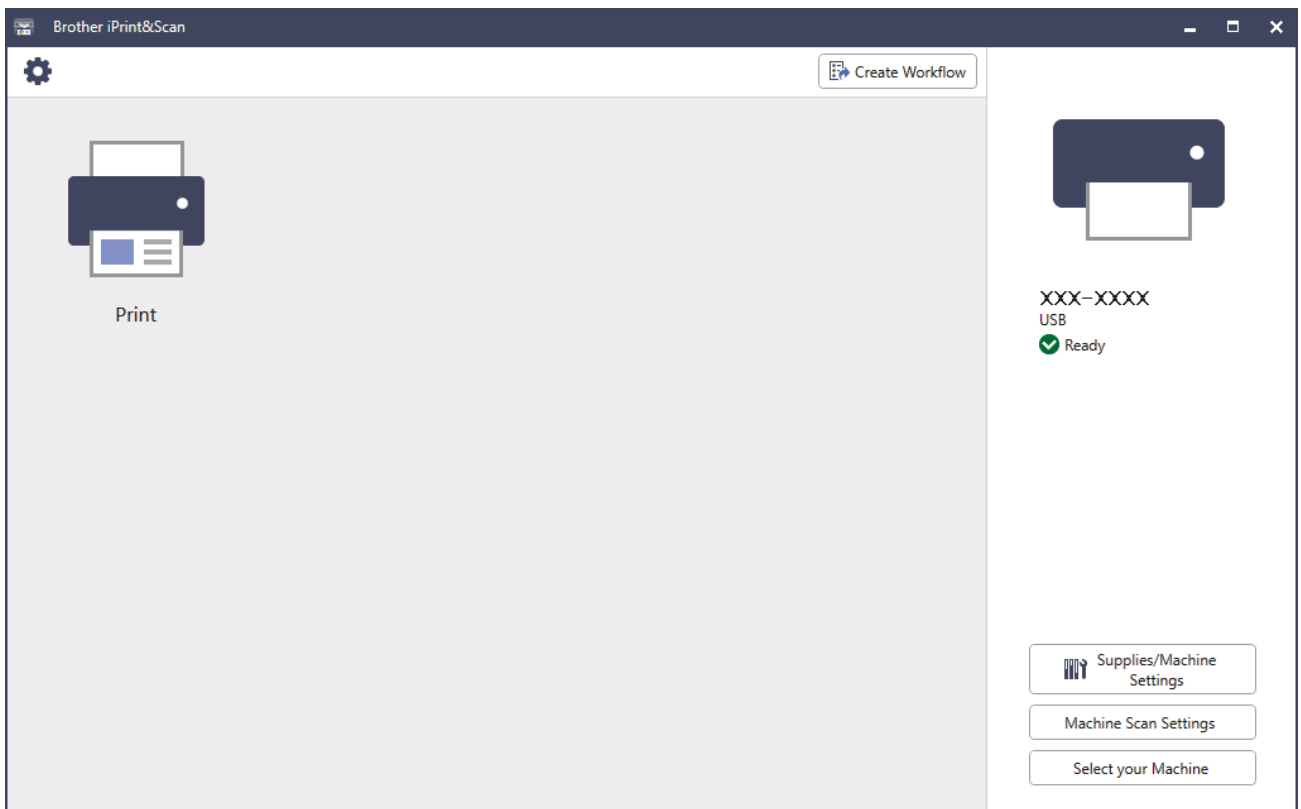

The actual screen may differ depending on the version of the application.

### ✓ Related Information

- [Introduction to Your Machine](#)

## Input/Output Port Locations on Your Machine

The input/output ports are located on the front and back of the machine.

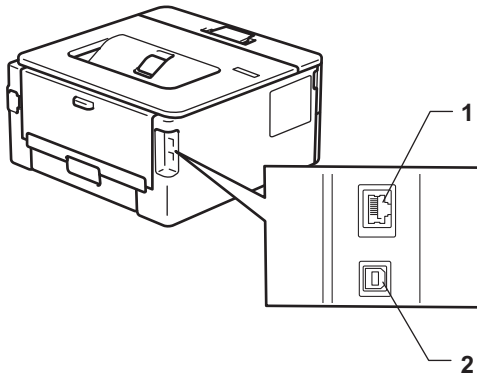

1. 10BASE-T / 100BASE-TX port (For network models)
2. USB port

When connecting the USB or network cable, follow the instructions in the software/driver installer.

To install driver and software necessary for operating your machine, go to your model's **Downloads** page at [support.brother.com/downloads](http://support.brother.com/downloads).



### Related Information

- [Introduction to Your Machine](#)

## Paper Handling

- [Load Paper](#)
- [Paper Settings](#)
- [Unprintable Area](#)
- [Recommended Print Media](#)
- [Using Special Paper](#)

## Load Paper

- [Load Paper in the Paper Tray](#)
- [Load and Print Plain Paper, Thin Paper, Recycled Paper and Bond Paper in the Manual Feed Slot](#)
- [Load and Print on Thick Paper and Labels Using the Manual Feed Slot](#)
- [Load and Print on Envelopes in the Manual Feed Slot](#)

## Load Paper in the Paper Tray

- If, when the Check Paper setting is set to On and you pull the paper tray out of the machine, a message appears on the LCD asking if you want to change the paper size and paper type, change these settings, if needed, following the LCD instructions.
- When you load a different size and type of paper in the tray, you must also change the Paper Size and Paper Type settings on the machine, or on your computer.

1. Pull the paper tray completely out of the machine.

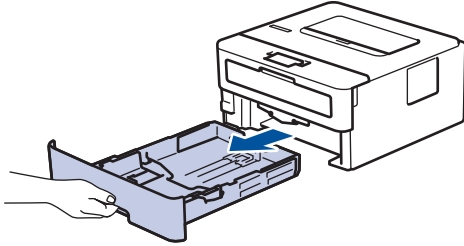

2. Press and slide the paper guides to fit the paper.  
Press the green release levers to slide the paper guides.

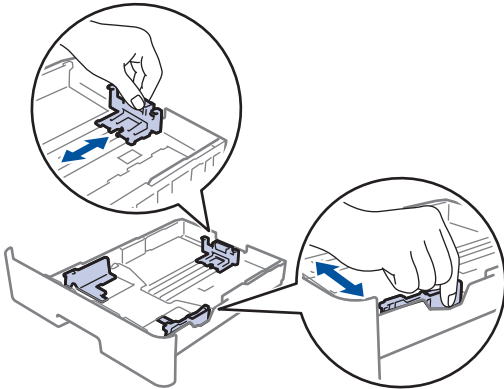

 For Legal or Folio size paper, press the release button (1) in the bottom of the paper tray and then pull out the back of the paper tray. (Legal and Folio size paper are not available in some regions.)

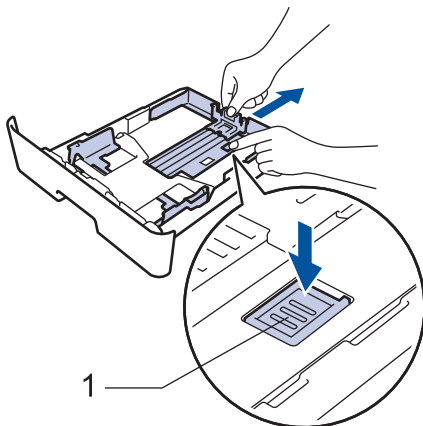

3. Fan the stack of paper well.
4. Load paper in the paper tray with the printing surface *face down*.

- 
5. Make sure the paper is below the maximum paper mark (▼▼▼).

Overfilling the paper tray will cause paper jams.

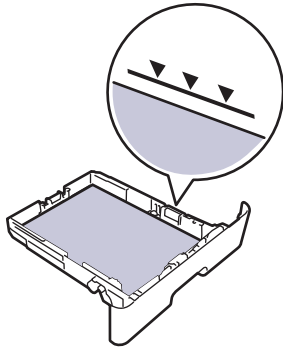

6. Slowly push the paper tray completely into the machine.
7. Lift the support flap to prevent paper from sliding off the output tray.

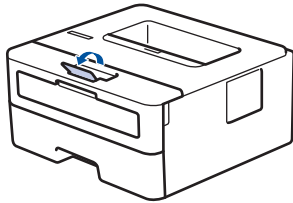

### Related Information

- [Load Paper](#)
  - [Change Machine Settings to Print on Preprinted Paper Using the Paper Tray](#)
-

## Change Machine Settings to Print on Preprinted Paper Using the Paper Tray

**Related Models:** HL-L2420DW/HL-L2460DW/HL-L2460DWXL/HL-L2865DW

When you use preprinted paper for 2-sided printing, change the machine's settings.



- DO NOT load different sizes and types of paper in the paper tray at the same time. Doing this may cause the paper to jam or misfeed.
- If the print position is misaligned with the preprinted objects, the print position is adjustable using the Print Position setting for the paper tray.
- Some preprinted paper may cause print stains, depending on the printing method and ink type.

### Orientation

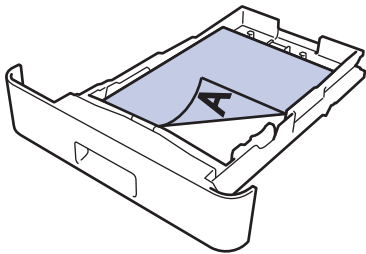
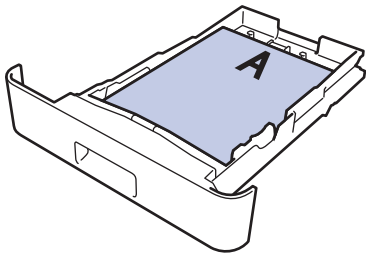
	For 1-sided printing <ul style="list-style-type: none"><li>• face down</li><li>• top edge toward the front of the paper tray</li></ul>
	For automatic 2-sided printing (long edge binding) <ul style="list-style-type: none"><li>• face up</li><li>• bottom edge toward the front of the paper tray</li></ul>

1. Press ▲ or ▼ to select the following:
  - a. Select [Printer]. Press **OK**.
  - b. Select [2-sided]. Press **OK**.
  - c. Select [Single Image]. Press **OK**.
2. Press ▲ or ▼ to select [2-sided Feed], and then press **Go**.



### Related Information

- [Load Paper in the Paper Tray](#)

## Load and Print Plain Paper, Thin Paper, Recycled Paper and Bond Paper in the Manual Feed Slot

When you load a different paper size in the tray, you must change the Paper Size setting in the machine or on your computer at the same time.

1. Lift the support flap to prevent paper from sliding off the face down output tray.

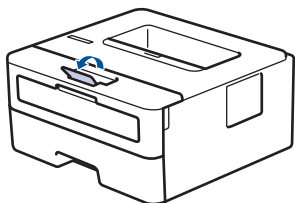

2. Open the manual feed slot cover.

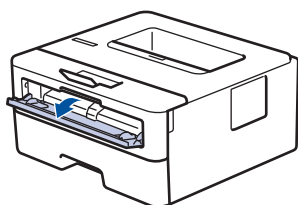

3. Use both hands to slide the manual feed slot paper guides to fit the width of the paper you are using.

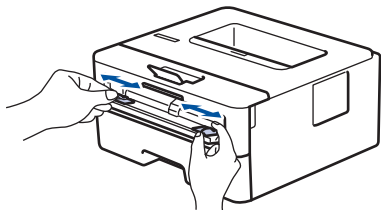

4. Using both hands, place one sheet of paper in the manual feed slot until the front edge touches the paper feed roller. When you feel the machine pull it in, let go.

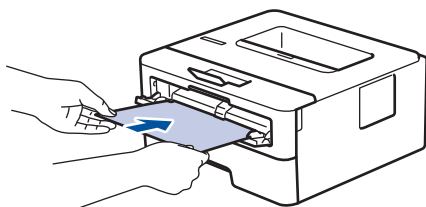

- Load paper into the manual feed slot with the printing surface *facing up*.
- Make sure the paper is straight and in the correct position in the manual feed slot. If it is not, the paper may not be fed correctly, resulting in a skewed printout or a paper jam.

5. Send your print job to the machine.



Change your print preferences in the Print screen.

6. After the printed page comes out from the machine, load the next sheet of paper in the manual feed slot. Repeat for each page that you want to print.



### Related Information

- [Load Paper](#)



## Load and Print on Thick Paper and Labels Using the Manual Feed Slot

When you load a different paper size in the tray, you must change the Paper Size setting in the machine or on your computer at the same time.

1. Open the machine's back cover (the face up output tray).

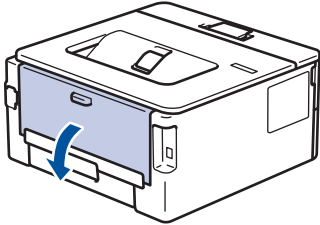

 The machine automatically turns on Manual Feed mode when you load paper in the manual feed slot.

2. On the front of the machine, open the manual feed slot cover.

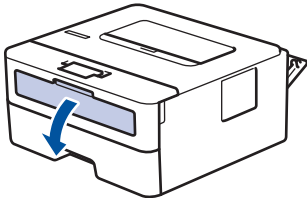

3. Use both hands to slide the manual feed slot paper guides to fit the width of the paper that you are using.

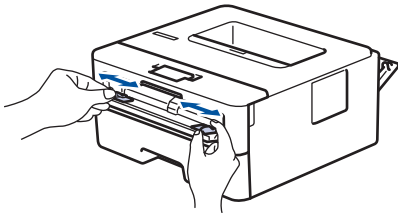

4. Using both hands, place one sheet of paper in the manual feed slot until the front edge touches the paper feed roller. When you feel the machine pull it in, let go.

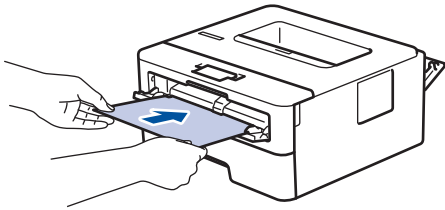

- 
- Load paper into the manual feed slot with the printing surface *facing up*.
  - Pull the paper out completely if you must reload the paper into the manual feed slot.
  - Do not put more than one sheet of paper in the manual feed slot at one time, as it may cause a jam.
  - Make sure the paper is straight and in the correct position in the manual feed slot. If it is not, the paper may not be fed correctly, resulting in a skewed printout or a paper jam.

5. Send your print job to the machine.

 Change your print preferences in the Print screen.

6. After the printed page comes out from the back of the machine, load the next sheet of paper in the manual feed slot. Repeat for each page that you want to print.
7. When finished, close the back cover (the face up output tray) until it locks in the closed position.



## Related Information

- [Load Paper](#)
-

## Load and Print on Envelopes in the Manual Feed Slot

Before loading, press the corners and sides of the envelopes to make them as flat as possible.

When you load a different paper size in the tray, you must change the Paper Size setting in the machine or on your computer at the same time.

1. Open the machine's back cover (the face up output tray).

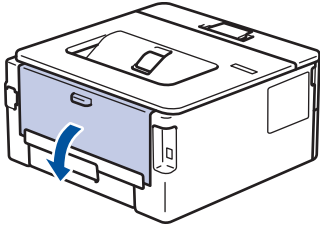

The machine automatically turns on Manual Feed mode when you load paper in the manual feed slot.

2. Pull down the two green levers, one on the left side and one on the right side, as shown in the illustration.

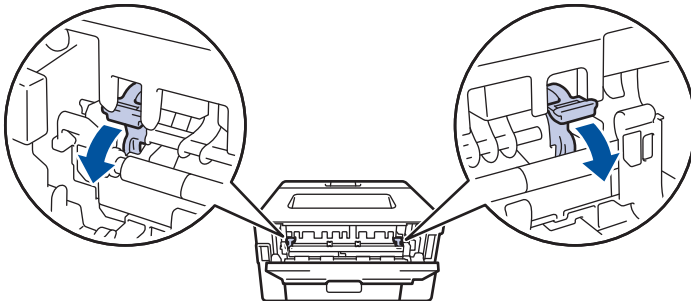

3. On the front of the machine, open the manual feed slot cover.

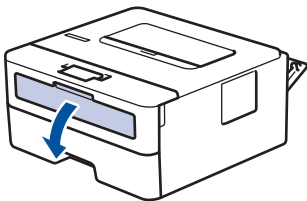

4. Use both hands to slide the manual feed slot paper guides to fit the width of the paper that you are using.

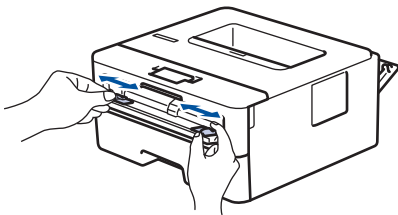

5. Using both hands, put one envelope in the manual feed slot until the front edge touches the paper feed roller. When you feel the machine pull it in, let go.

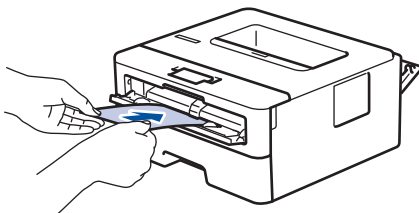



- Load the envelope into the manual feed slot with the printing surface *facing up*.
- Pull the envelope out completely when you reload the envelope into the manual feed slot.
- Do not put more than one envelope in the manual feed slot at one time, as it may cause a jam.
- Make sure the envelope is straight and in the correct position on the manual feed slot. If it is not, the envelope may not be fed correctly, resulting in a skewed printout or a paper jam.

6. Send your print job to the machine.



Change your print preferences in the Print dialog box.

Settings	Options for Envelopes
Paper Size	Com-10 DL C5 Monarch
Media Type	Envelopes Env. Thick Env. Thin

7. After the printed envelope comes out of the machine, put in the next envelope. Repeat for each envelope that you want to print.
8. When you have finished printing, return the two green levers you adjusted in the earlier step back to their original positions.
9. When finished, close the back cover (the face up output tray) until it locks in the closed position.



### Related Information

- [Load Paper](#)
- [Print](#)

## Paper Settings

- [Change the Paper Size and Paper Type](#)
- [Change the Check Paper Setting](#)
- [Print a Document \(Windows\)](#)

## Change the Paper Size and Paper Type

**Related Models:** HL-L2405W/HL-L2420DW/HL-L2460DW/HL-L2460DWXL/HL-L2865DW

When you change the size and type of paper you load in the tray, you must also change the Paper Size and Paper Type settings on the LCD.

1. Press ▲ or ▼ to select the following:
  - a. Select [General Setup]. Press **OK**.
  - b. Select [Tray Setting]. Press **OK**.
  - c. Select [Paper Type]. Press **OK**.
2. Press ▲ or ▼ to display the paper type you want, and then press **OK**.
3. Press ▲ or ▼ to display the [Paper Size] option, and then press **OK**.
4. Press ▲ or ▼ to display the paper size you want, and then press **Go**.



### Related Information

- [Paper Settings](#)

## Change the Check Paper Setting

**Related Models:** HL-L2405W/HL-L2420DW/HL-L2460DW/HL-L2460DWXL/HL-L2865DW

When the Check Paper setting is set to On and you pull the paper tray out of the machine, a message appears on the LCD asking if you want to change the paper size and paper type.

The default setting is On.

1. Press ▲ or ▼ to select the following:
  - a. Select [General Setup]. Press **OK**.
  - b. Select [Tray Setting]. Press **OK**.
  - c. Select [Check Paper]. Press **OK**.
2. Press ▲ or ▼ to select the [On] or [Off] option, and then press **Go**.



### Related Information

- [Paper Settings](#)

## Unprintable Area

The measurements in the table below show maximum unprintable areas from the edges of the most commonly used paper sizes. The measurements may vary depending on the paper size or settings in the application you are using.

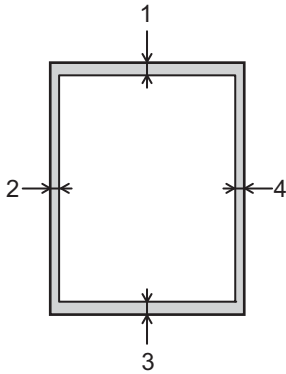

Do not attempt to print into these areas; your output will not reflect anything in these areas.

Usage	Document Size	Top (1) Bottom (3)	Left (2) Right (4)
Print	Letter	0.16 in. (4.2 mm)	0.16 in. (4.2 mm)
	A4	0.16 in. (4.2 mm)	0.16 in. (4.2 mm)
	Legal	0.16 in. (4.2 mm)	0.16 in. (4.2 mm)



### Related Information

- [Paper Handling](#)



## Recommended Print Media

To get the best print quality, we recommend using the paper listed in the table.

Paper Type	Item
Plain Paper	Xerox 4200DP 20 lb
	Hammermill Laser Print (24 lb = 90 g/m <sup>2</sup> )
Recycled Paper	No specific brand recommended
Labels	Avery laser labels white #5160
Envelopes	No specific brand recommended

### Related Information

- [Paper Handling](#)

#### Related Topics:

- [Improve the Print Quality](#)

## Using Special Paper

Always test paper samples before purchasing them to ensure desirable performance.

- DO NOT use inkjet paper; it may cause a paper jam or damage your machine.
- If you use bond paper, paper with a rough surface, or paper that is wrinkled or creased, the paper may exhibit degraded performance.

Store paper in its original packaging and keep it sealed. Keep the paper flat and away from moisture, direct sunlight, and heat.

### IMPORTANT

Some types of paper may not perform well or may cause damage to your machine.

DO NOT use paper:

- that is highly textured
- that is extremely smooth or shiny
- that is curled or warped
- that is coated or has a chemical finish
- that is damaged, creased, or folded
- that exceeds the recommended weight specification in this guide
- with tabs and staples
- that is multipart or carbonless
- that is designed for inkjet printing

If you use any of the types of paper listed above, they may damage your machine. This damage is not covered under any Brother warranty or service agreement.



### Related Information

- [Paper Handling](#)

## Print

- [Print from Your Computer \(Windows\)](#)
- [Print from Your Computer \(Mac\)](#)
- [Load and Print on Envelopes in the Manual Feed Slot](#)
- [Print an Email Attachment](#)
- [Change Print Settings Using the Control Panel](#)
- [Cancel a Print Job](#)
- [Test Print](#)

## **Print from Your Computer (Windows)**

- [Print a Document \(Windows\)](#)
- [Print on Both Sides of the Paper \(Windows\)](#)
- [Change the Default Print Settings \(Windows\)](#)
- [Print Settings \(Windows\)](#)
- [Monitor the Status of the Machine from Your Computer \(Windows\)](#)

## Print a Document (Windows)

When you change an application's print settings, the changes apply only to documents printed with that application.



- 2-sided printing may be the default depending on your model. For 1-sided printing, turn off the 2-sided printing settings in the printer driver. (HL-L2400D/HL-L2420DW/HL-L2460DW/HL-L2460DWXL/HL-L2865DW)
- To change print settings for all Windows applications, you must configure the printer driver properties. For more information, see *Related Information: Change the Default Print Settings (Windows)*.

1. Load paper in the paper tray.
2. Select the print command in your application.
3. Select your model's name, and then click the printer's properties or preferences button.

The printer driver window appears.

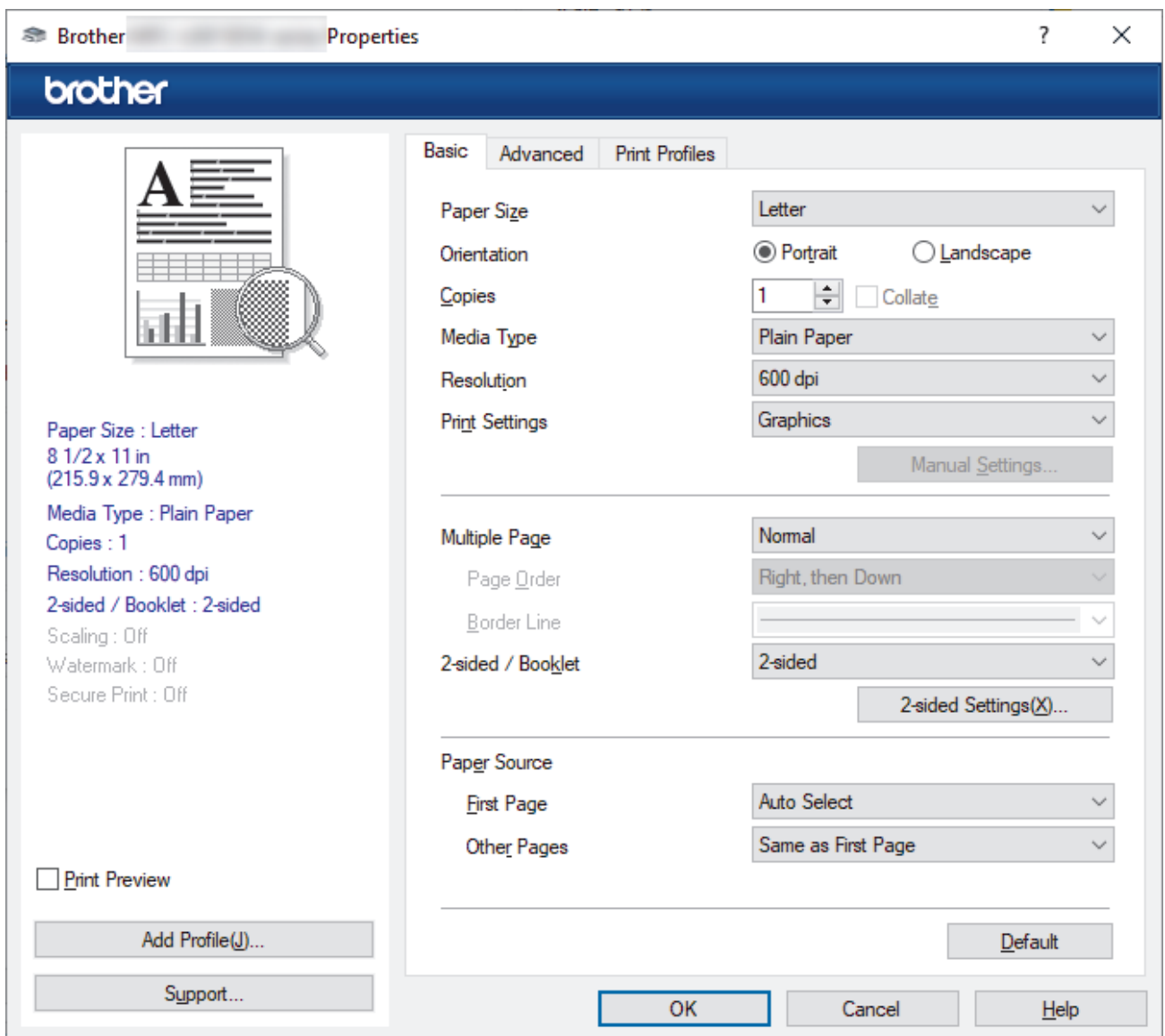

4. Make sure you have loaded the correct size paper in the paper tray.
5. Click the **Paper Size** drop-down list, and then select your paper size.

---

6. In the **Orientation** field, select the **Portrait** or **Landscape** option to set the orientation of your printout.



---

If your application contains a similar setting, we recommend that you set the orientation using the application.

---

7. Type the number of copies (1-999) you want in the **Copies** field.
8. Click the **Media Type** drop-down list, and then select the type of paper you are using.
9. To print multiple pages on a single sheet of paper or print one page of your document on multiple sheets, click the **Multiple Page** drop-down list, and then select your options.
10. Click the **2-sided / Booklet** drop-down list, and then select the option you want. (HL-L2400D/HL-L2420DW/HL-L2460DW/HL-L2460DWXL/HL-L2865DW)
11. Change other printer settings, if needed.
12. Click **OK**.
13. Complete your print operation.



### Related Information

- [Print from Your Computer \(Windows\)](#)

#### Related Topics:

- [Change the Default Print Settings \(Windows\)](#)
  - [Printing Problems](#)
  - [Paper Settings](#)
  - [Print Settings \(Windows\)](#)
-

## Print on Both Sides of the Paper (Windows)

**Related Models:** HL-L2400D/HL-L2420DW/HL-L2460DW/HL-L2460DWXL/HL-L2865DW

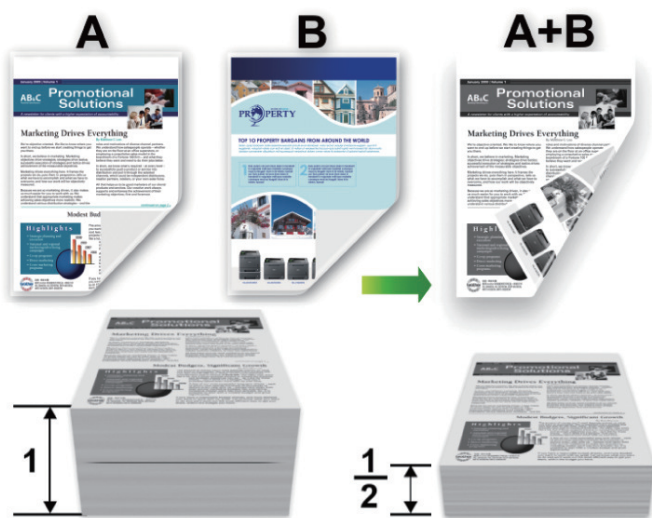

Select Letter, Legal, Mexico Legal, India Legal or Folio sized paper when using the automatic 2-sided printing function.

- Make sure the back cover is closed.
- If paper is curled, straighten it and put it back in the paper tray.
- Use regular paper or thin paper. DO NOT use bond paper.
- If the paper is too thin, it may wrinkle.
- When you use the manual 2-sided printing function, it is possible there may be paper jams or poor print quality.

1. Select the print command in your application.
2. Select your model's name, and then click the printer's properties or preferences button.  
The printer driver window appears.
3. In the **Orientation** field, select the **Portrait** or **Landscape** option to set the orientation of your printout.



If your application contains a similar setting, we recommend that you set the orientation using the application.

4. Click the **2-sided / Booklet** drop-down list, and then select the **2-sided** or **2-sided (Manual)** option.

Option	Description
<b>2-sided</b> (available for certain models)	Automatically prints on both sides of the paper.
<b>2-sided (Manual)</b>	The machine prints all the even-numbered pages on one side of the paper first. Then, the printer driver instructs you (with a pop-up message) to reinsert the paper.

5. Click the **2-sided Settings** button.
6. Select one of the options from the **2-sided Type** menu.  
When 2-sided is selected, four types of 2-sided binding are available for each orientation:

Option for Portrait	Description
---------------------	-------------

Long Edge (Left)

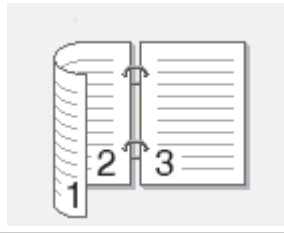

Long Edge (Right)



Short Edge (Top)

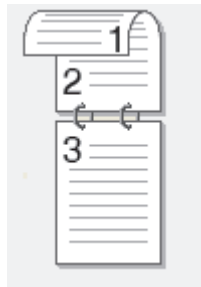

Short Edge (Bottom)

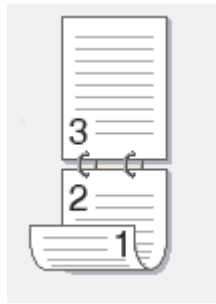

Option for Landscape	Description
----------------------	-------------

Long Edge (Top)

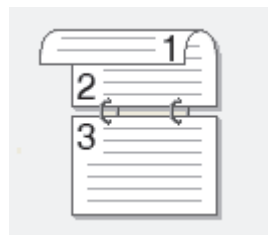

Long Edge (Bottom)

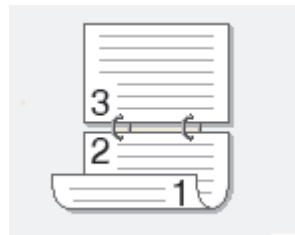

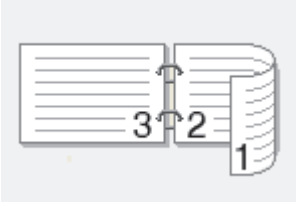
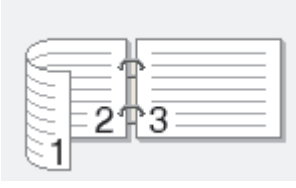

---

Option for Landscape	Description
Short Edge (Right)	
Short Edge (Left)	

7. Select the **Binding Offset** checkbox to specify the offset for binding in inches or millimeters.
8. Click **OK**.
9. Change other printer settings, if needed.
10. Do one of the following:
  - For automatic 2-sided printing, click **OK** again, and then complete your print operation.
  - For manual 2-sided printing, click **OK** again and follow the on-screen instructions.

If the paper is not feeding correctly, it may be curled. Remove the paper, straighten it, and put it back in the paper tray.



### Related Information

- [Print from Your Computer \(Windows\)](#)
-

## Change the Default Print Settings (Windows)

When you change an application's print settings, the changes apply only to documents printed with that application. To change print settings for all Windows applications, you must configure the printer driver properties.

1. Hold down the  key and press the  key on the computer's keyboard to launch **Run**.
2. Type "**control printers**" in the **Open:** field and click **OK**.

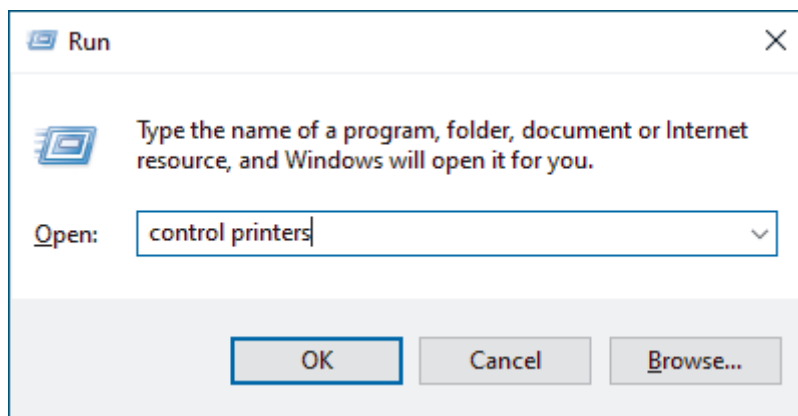

3. Right-click your model's icon, and then select **Printer properties**. (If the printer driver options appear, select your printer driver.)  
The printer properties dialog box appears.
4. Click the **General** tab, and then click the **Printing Preferences...** or **Preferences...** button.  
The printer driver dialog box appears.



- To configure the tray settings, click the **Device Settings** tab (available for certain models).
- To change the printer port, click the **Ports** tab.

5. Select the print settings you want to use as the default for all of your Windows programs.
6. Click **OK**.
7. Close the printer properties dialog box.

### ✓ Related Information

- [Print from Your Computer \(Windows\)](#)

#### Related Topics:

- [Print a Document \(Windows\)](#)
- [Print Settings \(Windows\)](#)
- [Printing Problems](#)

## Print Settings (Windows)



- When you change an application's print settings, the changes apply only to documents printed with that application.  
For more information, see *Related Information: Print a Document (Windows)*.
- To change the default print settings, you must configure the printer driver properties.  
For more information, see *Related Information: Change the Default Print Settings (Windows)*.

>> [Basic Tab](#)

>> [Advanced Tab](#)

### Basic Tab

The screenshot shows the Brother printer driver Properties dialog box, Basic Tab. The dialog is titled "Brother Properties" and has a "brother" logo at the top. On the left side, there is a preview of a document with a magnifying glass over a grid pattern. Below the preview, the following settings are listed: Paper Size: Letter (8 1/2 x 11 in / 215.9 x 279.4 mm), Media Type: Plain Paper, Copies: 1, Resolution: 600 dpi, 2-sided / Booklet: 2-sided, Scaling: Off, Watermark: Off, and Secure Print: Off. There is a "Print Preview" checkbox which is unchecked. Below these are buttons for "Add Profile(J)..." and "Support...". The main area of the dialog is divided into three tabs: "Basic", "Advanced", and "Print Profiles". The "Basic" tab is selected. It contains the following settings: Paper Size (Letter), Orientation (Portrait selected, Landscape unselected), Copies (1, Collate unselected), Media Type (Plain Paper), Resolution (600 dpi), and Print Settings (Graphics). There is a "Manual Settings..." button below these. Below the Print Settings section are sections for Multiple Page settings: Multiple Page (Normal), Page Order (Right, then Down), Border Line (a line with a dropdown arrow), 2-sided / Booklet (2-sided), and a "2-sided Settings(X)..." button. Below these are Paper Source settings: First Page (Auto Select) and Other Pages (Same as First Page). At the bottom right of the dialog is a "Default" button. At the very bottom of the dialog are three buttons: "OK", "Cancel", and "Help".

#### 1. Paper Size

Select the paper size you want to use. You can either choose from standard paper sizes or create a custom paper size.

#### 2. Orientation

Select the orientation (portrait or landscape) of your printout.

If your application contains a similar setting, we recommend that you set the orientation using the application.

---

### 3. Copies

Type the number of copies (1-999) that you want to print in this field.

#### Collate

Select this option to print sets of multi-page documents in the original page order. When this option is selected, one complete copy of your document will print, and then reprint according to the number of copies you choose. If this option is not selected, then each page will print according to the number of copies chosen before the next page of the document is printed.

### 4. Media Type

Select the media type you want to use. To achieve the best print results, the machine automatically adjusts its print settings according to the selected media type.

### 5. Resolution

Select the print resolution. As print resolution and speed are related, the higher the resolution, the longer it will take to print the document.

### 6. Print Settings

Select the type of document you want to print.

#### Manual Settings...

Specify additional settings such as brightness, contrast, and other settings.

#### Graphics

##### Use Printer Halftone

Select this option to use the printer driver to express halftones.

##### Brightness

Adjust the brightness.

##### Contrast

Adjust the contrast.

##### Graphics Quality

Select either Graphics or Text for the best print quality, based on the type of document you are printing.

##### Improve Gray Printing

Select this option to improve the image quality of shaded areas.

##### Improve Pattern Printing

Select this option to improve the pattern printing if printed fills and patterns are different from the fills and patterns you see on your computer screen.

##### Improve Thin Line

Select this option to improve the image quality of thin lines.

##### Use System Halftone

Select this option to use Windows to express halftones.

#### TrueType Mode (available for certain models)

##### Mode

Select how the fonts are processed for printing.

##### Use Printer TrueType Fonts

Select whether to use built-in fonts for the font processing.

### 7. Multiple Page

Select this option to print multiple pages on a single sheet of paper, or print one page of your document on multiple sheets.

## Page Order

Select the page order when printing multiple pages on a single sheet of paper.

## Border Line

Select the type of border to use when printing multiple pages on a single sheet of paper.

## 8. 2-sided / Booklet

Select this option to print on both sides of the paper, or print a document in booklet format using 2-sided printing.

### 2-sided Settings

Click this button to select the type of 2-sided binding. Four types of 2-sided bindings are available for each orientation.

## 9. Paper Source

Select the paper source setting according to your print conditions or purpose.

### First Page

Select the paper source to use for printing the first page.

### Other Pages

Select the paper source to use for printing the second and subsequent pages.

## Advanced Tab

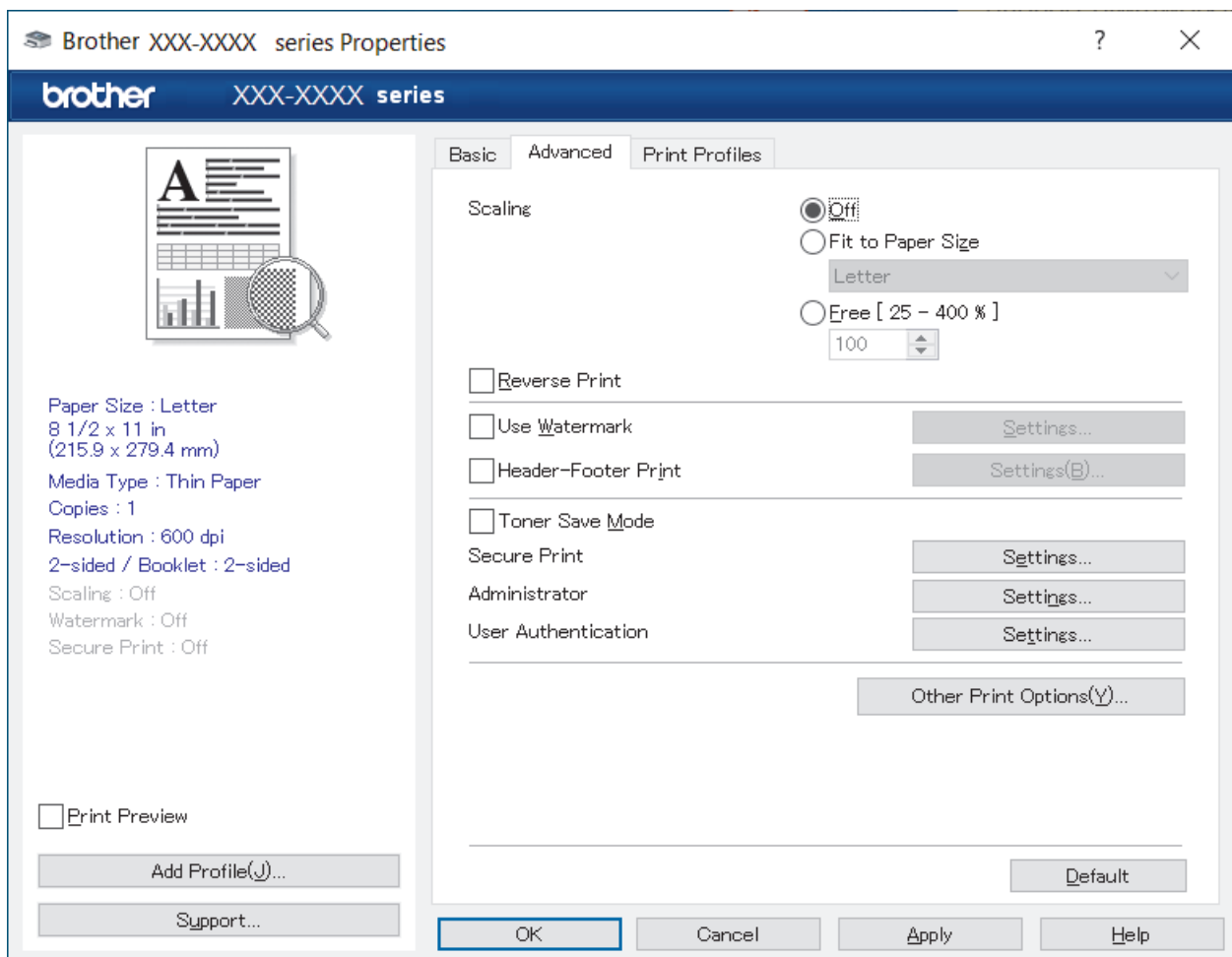

## 1. Scaling

Select these options to enlarge or reduce the size of the pages in your document.

### Fit to Paper Size

Select this option to enlarge or reduce the document pages to fit a specified paper size. When you select this option, select the paper size you want from the drop-down list.

---

### **Free [25 - 400%]**

Select this option to enlarge or reduce the document pages manually. When you select this option, type a value into the field.

### **2. Reverse Print**

Select this option to rotate the printed image 180 degrees.

### **3. Use Watermark**

Select this option to print a logo or text on your document as a watermark. Select one of the preset watermarks, add a new watermark, or use an image file you have created.

### **4. Header-Footer Print**

Select this option to print the date, time, and login user name on the document.

### **5. Toner Save Mode**

Select this feature to use less toner to print documents; printouts appear lighter, but are still legible.

### **6. Administrator**

This feature allows you to change the administrator password and restrict various printing functions.

### **7. User Authentication (available for certain models)**

This feature allows you to confirm the restrictions for each user.

### **8. Other Print Options**

#### **Sleep Time**

Select this option to set the machine to enter sleep mode immediately after printing.

#### **Macro (available for certain models)**

Select this feature to print an electronic form (macro), which you have stored in your machine's memory, as an overlay on the print job.

#### **Density Adjustment**

Specify the print density.

#### **Improve Print Output**

Select this option to reduce the amount of paper curling and improve the toner fixing.

#### **Skip Blank Page**

Select this option to allow the printer driver to automatically detect blank pages and exclude them from printing.

#### **Print Text in Black**

Select this option when you want to print color text in black.

#### **Print Archive**

Select this option to save the print data as a PDF file to your computer.

#### **Eco settings**

Select this option to reduce printing noise.



### **Related Information**

- [Print from Your Computer \(Windows\)](#)



#### **Related Topics:**

- [Change the Default Print Settings \(Windows\)](#)
  - [Print a Document \(Windows\)](#)
-

## Monitor the Status of the Machine from Your Computer (Windows)

The Status Monitor is a configurable software tool for monitoring the status of one or more machines, allowing you to get immediate notification of errors.

Do one of the following:

- Double-click the  icon in the task tray.
- Launch  (**Brother Utilities**), and then click the drop-down list and select your model's name (if not already selected). Click **Tools** in the left navigation bar, and then click **Status Monitor**.

### Troubleshooting

Click the **Troubleshooting** button to access the support website.

### Visit the Genuine Supplies website

Click the **Visit the Genuine Supplies website** button for more information on Brother genuine supplies.

### Related Information

- [Print from Your Computer \(Windows\)](#)

#### Related Topics:

- [Printing Problems](#)
-

## **Print from Your Computer (Mac)**

- [Before Using AirPrint \(macOS\)](#)
- [Print Using AirPrint](#)



## Load and Print on Envelopes in the Manual Feed Slot

Before loading, press the corners and sides of the envelopes to make them as flat as possible.

When you load a different paper size in the tray, you must change the Paper Size setting in the machine or on your computer at the same time.

1. Open the machine's back cover (the face up output tray).

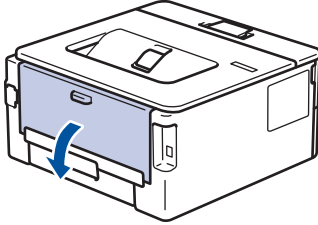

The machine automatically turns on Manual Feed mode when you load paper in the manual feed slot.

2. Pull down the two green levers, one on the left side and one on the right side, as shown in the illustration.

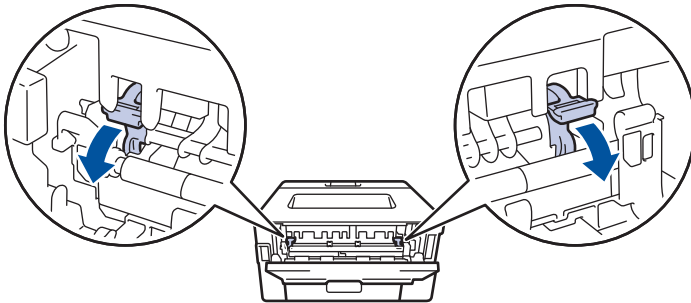

3. On the front of the machine, open the manual feed slot cover.

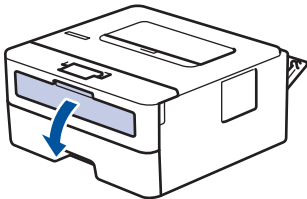

4. Use both hands to slide the manual feed slot paper guides to fit the width of the paper that you are using.

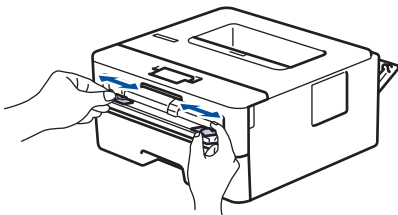

5. Using both hands, put one envelope in the manual feed slot until the front edge touches the paper feed roller. When you feel the machine pull it in, let go.

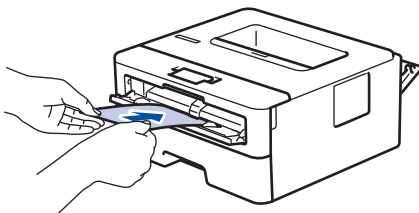



- Load the envelope into the manual feed slot with the printing surface *facing up*.
- Pull the envelope out completely when you reload the envelope into the manual feed slot.
- Do not put more than one envelope in the manual feed slot at one time, as it may cause a jam.
- Make sure the envelope is straight and in the correct position on the manual feed slot. If it is not, the envelope may not be fed correctly, resulting in a skewed printout or a paper jam.

6. Send your print job to the machine.



Change your print preferences in the Print dialog box.

Settings	Options for Envelopes
Paper Size	Com-10 DL C5 Monarch
Media Type	Envelopes Env. Thick Env. Thin

7. After the printed envelope comes out of the machine, put in the next envelope. Repeat for each envelope that you want to print.
8. When you have finished printing, return the two green levers you adjusted in the earlier step back to their original positions.
9. When finished, close the back cover (the face up output tray) until it locks in the closed position.



### Related Information

- [Load Paper](#)
- [Print](#)

## Print an Email Attachment

You can print files by emailing them to your Brother machine.

- Make sure Web Based Management is set to On. For more information, see *Related Information*.
- You can attach up to 10 documents, 20 MB in total, to an email.
- This feature supports the following formats:
  - Document files: PDF, TXT, and Microsoft Office files
  - Image files: JPEG, BMP, GIF, PNG, and TIFF
- The machine prints both the email content and attachments by default. To print only email attachments, change the settings as necessary.

1. Start your web browser.
2. Type "https://machine's IP address" in your browser's address bar (where "machine's IP address" is your machine's IP address).

For example:

https://192.168.1.2

3. If required, type the password in the **Login** field, and then click **Login**.



The default password to manage this machine's settings is located on the back of the machine and marked "**Pwd**". Change the default password by following the on-screen instructions when you first log in.

4. In the left navigation bar, click **Online Functions** > **Online Functions Settings**.



- If the left navigation bar is not visible, start navigating from ☰.
- If this function is locked, contact your network administrator for access.

5. Click the **I accept the terms and conditions** button.
6. Go to your machine, and then follow the machine's instructions to enable the settings.
7. On your computer, click **General Settings**.

The **Email Print: General Settings** screen appears.

8. Click the **Enable** button.  
The machine prints the instruction sheet.
9. Send your email to the email address included on the sheet. The machine prints the email attachments.



To change the settings, including email address and printer settings, click the **Online Functions Settings Page** button.



### Related Information

- [Print](#)

#### Related Topics:

- [Enable/Disable Web Based Management Using the Control Panel](#)

## Change Print Settings Using the Control Panel

**Related Models:** HL-L2460DW/HL-L2460DWXL/HL-L2865DW

Select the type of document you want to print.

1. Press ▲ or ▼ to display the [Printer] option, and then press **OK**.
2. Press ▲ or ▼ to display the [Print Settings] option, and then press **OK**.
3. Press ▲ or ▼ to display the [Graphics] or [Text] option, and then choose the option you want.
4. Press **Go**.



### Related Information

- [Print](#)
-

## Cancel a Print Job

On the machine's control panel, press and hold **Go** for about two seconds to cancel the current print job.



To cancel multiple print jobs, press and hold **Go** for six seconds.



### Related Information

- [Print](#)

#### Related Topics:

- [Printing Problems](#)
-

## Test Print

**Related Models:** HL-L2405W/HL-L2420DW/HL-L2460DW/HL-L2460DWXL/HL-L2865DW

If there are problems with print quality, follow these instructions to do a test print:

1. Press ▲ or ▼ to display the [Printer] option, and then press **OK**.
2. (HL-L2460DW/HL-L2460DWXL/HL-L2865DW) Press ▲ or ▼ to display the [Print Options] option, and then press **OK**.
3. Press ▲ or ▼ to display the [Test Print] option, and then press **OK**.
4. Press **Go**.

The machine prints the test page.

### ✓ Related Information

- [Print](#)

#### Related Topics:

- [Improve the Print Quality](#)

## Network

**Related Models:** HL-L2405W/HL-L2420DW/HL-L2460DW/HL-L2460DWXL/HL-L2865DW

- [Supported Basic Network Features](#)
- [Configure Network Settings](#)
- [Wireless Network Settings](#)
- [Network Features](#)

## Supported Basic Network Features

**Related Models:** HL-L2405W/HL-L2420DW/HL-L2460DW/HL-L2460DWXL/HL-L2865DW

The machine supports various features depending on the operating system. Use this table to see which network features and connections are supported by each operating system.

Operating Systems	Windows	Windows Server	macOS
Printing	Yes	Yes	Yes
Web Based Management <sup>1</sup>	Yes	Yes	Yes
Status Monitor	Yes		
Driver Deployment Wizard	Yes	Yes	

<sup>1</sup> The default password to manage your machine's settings is located on the back of the machine and marked "Pwd". We recommend immediately changing the default password to protect your machine from unauthorized access.



- When connecting your machine to an outside network such as the Internet, make sure your network environment is protected by a separate firewall or other means in order to prevent information leaks due to inadequate settings or unauthorized access by malicious third parties.
- When your machine is connected to the global network, a warning appears. When you see this warning, we strongly recommend confirming your network settings, and then re-connecting to a secure network.
- Enabling your machine's global network communication filtering feature blocks access from the global network. The global network communication filtering feature may prevent the machine from receiving certain print jobs from a computer or mobile device that uses a global IP address.



### Related Information

- [Network](#)

#### Related Topics:

- [Change the Login Password Using Web Based Management](#)



## Configure Network Settings

**Related Models:** HL-L2405W/HL-L2420DW/HL-L2460DW/HL-L2460DWXL/HL-L2865DW

- [Configure Network Details Using the Control Panel](#)
- [Change Machine Settings Using Web Based Management](#)

## Configure Network Details Using the Control Panel

**Related Models:** HL-L2405W/HL-L2420DW/HL-L2460DW/HL-L2460DWXL/HL-L2865DW

To configure the machine for your network, use the control panel's [Network] menu selections.



- For information about the network settings you can configure using the control panel, see *Related Information: Settings Tables*.
- You can also use Web Based Management, to configure and change your machine's network settings.

1. Press ▲ or ▼ to select the [Network] option, and then press **OK**.
2. Press ▲ or ▼ to select the network option you want, and then press **OK**. Repeat this step until you access the menu you want to configure, and then follow the LCD instructions.



### Related Information

- [Configure Network Settings](#)

#### Related Topics:

- [Settings Tables \(HL-L2405W/HL-L2420DW/HL-L2460DW/HL-L2460DWXL/HL-L2865DW\)](#)
- [Supported Basic Network Features](#)

## Wireless Network Settings

**Related Models:** HL-L2405W/HL-L2420DW/HL-L2460DW/HL-L2460DWXL/HL-L2865DW

- [Use the Wireless Network](#)
- [Use Wi-Fi Direct<sup>®</sup>](#)
- [Enable/Disable Wireless LAN](#)
- [Print the WLAN Report](#)

## Use the Wireless Network

**Related Models:** HL-L2405W/HL-L2420DW/HL-L2460DW/HL-L2460DWXL/HL-L2865DW

- [Before Configuring Your Machine for a Wireless Network](#)
- [Configure Your Machine for a Wireless Network Using the Setup Wizard from Your Computer](#)
- [Configure Your Machine for a Wireless Network Using the Machine's Control Panel Setup Wizard](#)
- [Configure Your Machine for a Wireless Network Using the One Push Method of Wi-Fi Protected Setup™ \(WPS\)](#)
- [Configure Your Machine for a Wireless Network Using the PIN Method of Wi-Fi Protected Setup™ \(WPS\)](#)
- [Configure Your Machine for a Wireless Network When the SSID Is Not Broadcast](#)
- [Configure Your Machine for an Enterprise Wireless Network](#)

## Before Configuring Your Machine for a Wireless Network

**Related Models:** HL-L2405W/HL-L2420DW/HL-L2460DW/HL-L2460DWXL/HL-L2865DW

Before attempting to configure a wireless network, confirm the following:

- If you are using an enterprise wireless network, you must know the User ID and Password.
- To achieve optimum results with normal everyday document printing, place your machine as close to the wireless LAN access point/router as possible with minimal obstructions. Large objects and walls between the two devices and interference from other electronic devices can affect the data transfer speed of your documents.

Due to these factors, wireless may not be the best method of connection for all types of documents and applications. If you are printing large files, such as multi-page documents with mixed text and large graphics, you may want to consider selecting wired Ethernet for faster data transfer (supported models only), or USB for the fastest throughput speed.

- Although your machine can be used in a wired and wireless network (supported models only), only one connection method can be used at a time. However, a wireless network connection and Wi-Fi Direct connection, or a wired network connection (supported models only) and Wi-Fi Direct connection can be used at the same time.
- If there is a signal in the vicinity, wireless LAN allows you to freely make a LAN connection. However, if security settings are not correctly configured, the signal may be intercepted by malicious third-parties, possibly resulting in:
  - Theft of personal or confidential information
  - Improper transmission of information to parties impersonating the specified individuals
  - Dissemination of transcribed communication contents that were intercepted



Make sure you know your wireless router/access point's Network Name (SSID) and Network Key (Password). If you cannot find this information, consult the manufacturer of your wireless router/access point, your system administrator, or Internet provider. Brother cannot provide this information.



### Related Information

- [Use the Wireless Network](#)

## Configure Your Machine for a Wireless Network Using the Setup Wizard from Your Computer

**Related Models:** HL-L2405W/HL-L2420DW/HL-L2460DW/HL-L2460DWXL/HL-L2865DW

1. Download the installer from your model's **Downloads** page at [support.brother.com/downloads](http://support.brother.com/downloads).
2. Start the installer, and then follow the on-screen instructions.
3. Select **Wireless Network Connection (Wi-Fi)**, and then click **Next**.
4. Follow the on-screen instructions.

You have completed the wireless network setup.



### Related Information

- [Use the Wireless Network](#)

## Configure Your Machine for a Wireless Network Using the Machine's Control Panel Setup Wizard

**Related Models:** HL-L2405W/HL-L2420DW/HL-L2460DW/HL-L2460DWXL/HL-L2865DW

Before configuring your machine, we recommend writing down your wireless network settings. You will need this information before you continue with the configuration.

1. Check and record the current wireless network settings of the computer to which you are connecting.

Network Name (SSID)

Network Key

For example:

Network Name (SSID)
HELLO

Network Key
12345



- Your access point/router may support the use of multiple WEP keys, but your Brother machine supports the use of only the first WEP key.
- If you need assistance during setup and want to contact Brother Customer Service, make sure you have your SSID (Network Name) and Network Key (Password) ready. We cannot assist you in locating this information.
- If you do not know this information (SSID and Network Key), you cannot continue the wireless setup.

### How can I find this information?

- Check the documentation provided with your wireless access point/router.
- The initial SSID could be the manufacturer's name or the model name.
- If you do not know the security information, consult the router manufacturer, your system administrator, or your Internet provider.

2. Press ▲ or ▼ to select the [Network] option, and then press **OK**.
3. Press ▲ or ▼ to select the [WLAN (Wi-Fi)] option, and then press **OK**.
4. Press ▲ or ▼ to select the [Find Network] option, and then press **OK**.
5. When [WLAN Enable?] appears, select On.  
This will start the wireless setup wizard.
6. The machine will search for your network and display a list of available SSIDs. When a list of SSIDs appears, press ▲ or ▼ to select the SSID you want.
7. Press **OK**.
8. Do one of the following:
  - If you are using an authentication and encryption method that requires a Network Key, enter the Network Key you wrote down in the first step.  
When you have entered all the characters, press **OK**.

---

To apply the settings, select [Yes].

- If your authentication method is Open System and your encryption mode is None, go to the next step.

9. The machine attempts to connect to the wireless device you have selected.

If your wireless device is connected successfully, the machine's LCD displays [Connected].

You have completed the wireless network setup. To install the drivers and software necessary to use your machine, go to your model's **Downloads** page at [support.brother.com/downloads](http://support.brother.com/downloads).



## Related Information

- [Use the Wireless Network](#)

### Related Topics:

- [How to Enter Text on Your Machine](#)
  - [Wireless LAN Report Error Codes](#)
-



## Configure Your Machine for a Wireless Network Using the One Push Method of Wi-Fi Protected Setup™ (WPS)

**Related Models:** HL-L2405W/HL-L2420DW/HL-L2460DW/HL-L2460DWXL/HL-L2865DW

If your wireless access point/router supports WPS (PBC: Push Button Configuration), you can use WPS from your machine's control panel menu to configure your wireless network settings.

1. Press ▲ or ▼ to select the [Network] option, and then press **OK**.
2. Press ▲ or ▼ to select the [WLAN (Wi-Fi)] option, and then press **OK**.
3. Press ▲ or ▼ to select the [WPS/Push Button] option, and then press **OK**.
4. When [WLAN Enable?] appears, select **On**.  
This will start the wireless setup wizard.
5. When the LCD displays [Press Key on rtr], press the WPS button on your wireless access point/router. Then follow the LCD instructions on your machine. Your machine will automatically detect your wireless access point/router and try to connect to your wireless network.

If your wireless device is connected successfully, the machine's LCD displays [Connected].

You have completed the wireless network setup. To install the drivers and software necessary to use your machine, go to your model's **Downloads** page at [support.brother.com/downloads](http://support.brother.com/downloads).



### Related Information

- [Use the Wireless Network](#)

#### Related Topics:

- [Wireless LAN Report Error Codes](#)

## Configure Your Machine for a Wireless Network Using the PIN Method of Wi-Fi Protected Setup™ (WPS)

**Related Models:** HL-L2405W/HL-L2420DW/HL-L2460DW/HL-L2460DWXL/HL-L2865DW

If your wireless LAN access point/router supports WPS, you can use the Personal Identification Number (PIN) Method to configure your wireless network settings.

The PIN Method is one of the connection methods developed by the Wi-Fi Alliance®. By submitting a PIN created by an Enrollee (your machine) to the Registrar (a device that manages the wireless LAN), you can set up the wireless network and security settings. For more information on how to access WPS mode, see the instructions provided with your wireless access point/router.

### Type A

Connection when the wireless LAN access point/router (1) doubles as the Registrar:

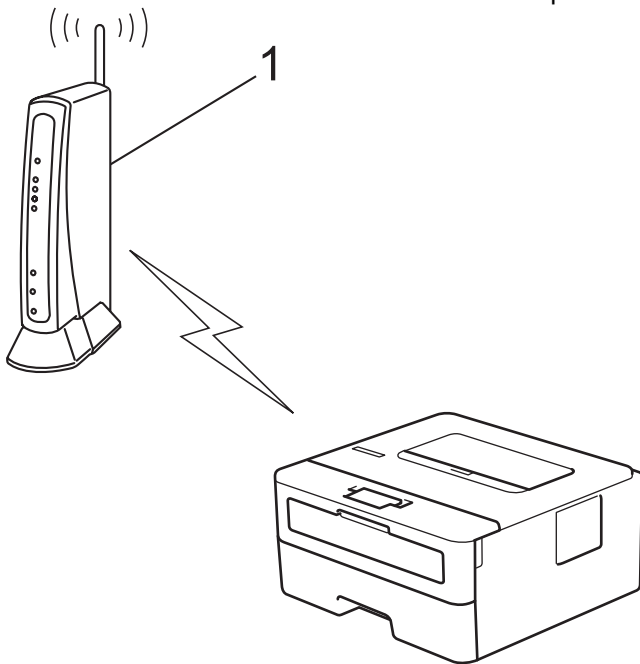

### Type B

Connection when another device (2), such as a computer, is used as the Registrar:

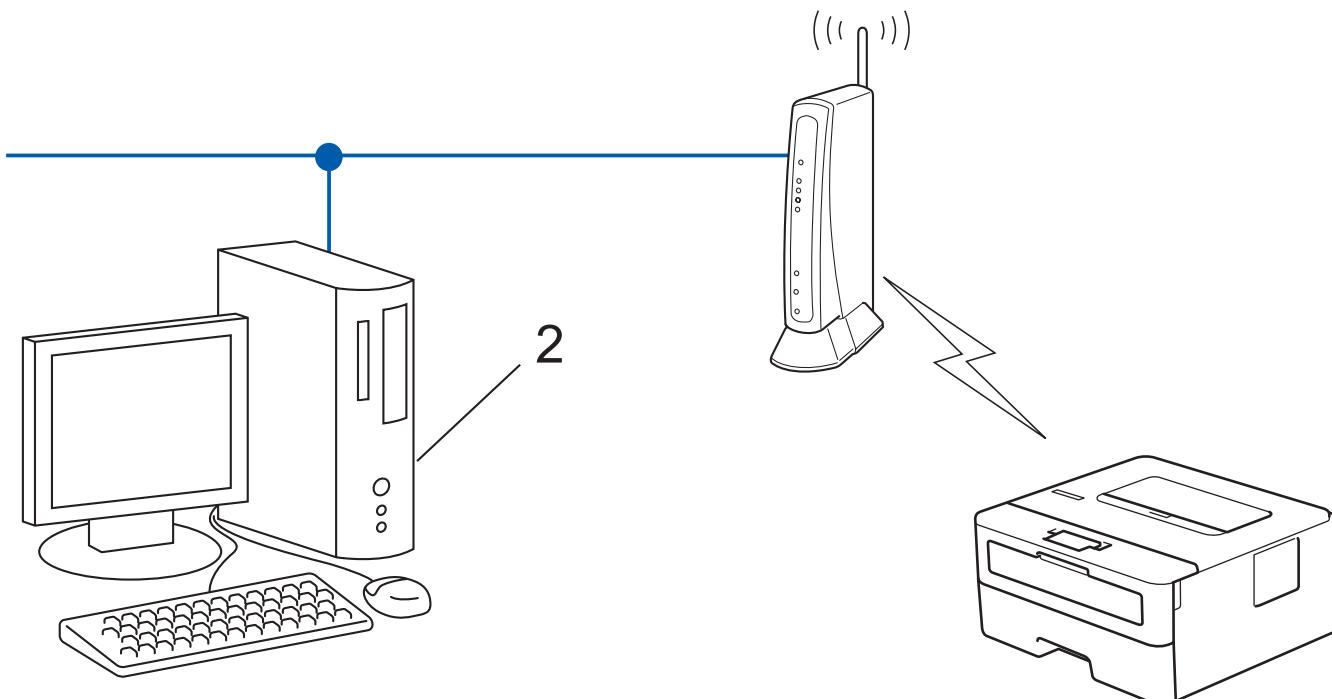



1. Press ▲ or ▼ to select the [Network] option, and then press **OK**.
2. Press ▲ or ▼ to select the [WLAN (Wi-Fi)] option, and then press **OK**.
3. Press ▲ or ▼ to select the [WPS/PIN Code] option, and then press **OK**.
4. When [WLAN Enable?] appears, select On.  
This will start the wireless setup wizard.
5. The LCD displays an eight-digit PIN and the machine starts searching for a wireless LAN access point/router.
6. Using a computer connected to the network, in your browser's address bar, type the IP address of the device you are using as the Registrar (for example: <http://192.168.1.2>).
7. Go to the WPS settings page and type the PIN, and then follow the on-screen instructions.



- The Registrar is usually the wireless LAN access point/router.
- The settings page may differ depending on the brand of wireless LAN access point/router. For more information, see the instructions supplied with your wireless LAN access point/router.

**If you are using a Windows 10 or Windows 11 computer as a Registrar, complete the following steps:**

8. Hold down the  key and press the  key on the computer's keyboard to launch **Run**.
9. Type "**control printers**" in the **Open:** field and click **OK**.

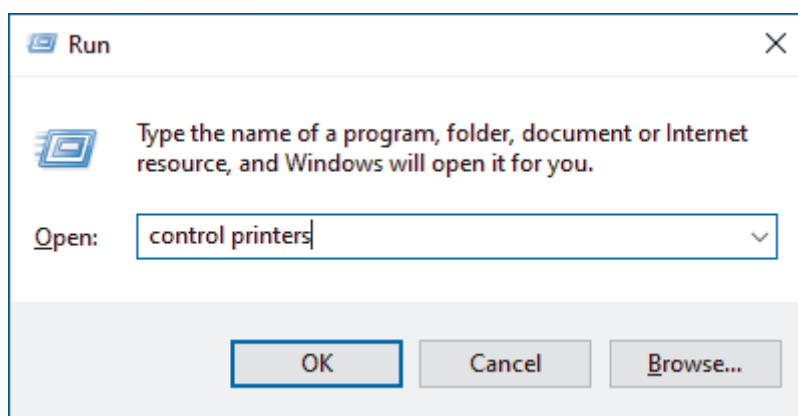

10. Click **Add a device**.



- To use a Windows 10 or Windows 11 computer as a Registrar, you must register it to your network in advance. For more information, see the instructions supplied with your wireless LAN access point/router.
- If you use Windows 10 or Windows 11 as a Registrar, you can install the printer driver after the wireless configuration by following the on-screen instructions. To install the driver and software necessary to use your machine, go to your model's **Downloads** page at [support.brother.com/downloads](http://support.brother.com/downloads).

11. Select your machine and click **Next**.

12. Type the PIN displayed on the machine's LCD, and then click **Next**.

13. Click **Close**.

If your wireless device is connected successfully, the machine's LCD displays [Connected].

You have completed the wireless network setup. To install the drivers and software necessary to use your machine, go to your model's **Downloads** page at [support.brother.com/downloads](http://support.brother.com/downloads).



### Related Information

- [Use the Wireless Network](#)

#### Related Topics:

- [Wireless LAN Report Error Codes](#)

## Configure Your Machine for a Wireless Network When the SSID Is Not Broadcast

**Related Models:** HL-L2405W/HL-L2420DW/HL-L2460DW/HL-L2460DWXL/HL-L2865DW

Before configuring your machine, we recommend writing down your wireless network settings. You will need this information before you continue with the configuration.

1. Check and write down the current wireless network settings.

Network Name (SSID)		
Authentication Method	Encryption Mode	Network Key
Open System	NONE	-
	WEP	
Shared Key	WEP	
WPA/WPA2-PSK	AES	
	TKIP	
WPA3-SAE	AES	

For example:

Network Name (SSID)		
HELLO		
Authentication Method	Encryption Mode	Network Key
WPA2-PSK	AES	12345678



If your router uses WEP encryption, enter the key used as the first WEP key. Your Brother machine supports the use of the first WEP key only.

2. Press **▲** or **▼** to select the [Network] option, and then press **OK**.
3. Press **▲** or **▼** to select the [WLAN (Wi-Fi)] option, and then press **OK**.
4. Press **▲** or **▼** to select the [Find Network] option, and then press **OK**.
5. When [WLAN Enable?] appears, select On.  
This will start the wireless setup wizard.
6. The machine will search for your network and display a list of available SSIDs. Press **▲** or **▼** to select the [<New SSID>] option, and then press **OK**.
7. Enter the SSID name, and then press **OK**.
8. Press **▲** or **▼** to select the Authentication Method you want, and then press **OK**.
9. Do one of the following:
  - If you selected the [Open System] option, press **▲** or **▼** to select the Encryption Type [None] or [WEP], and then press **OK**.  
If you selected the [WEP] option for Encryption Type, enter the WEP key, and then press **OK**.
  - If you selected the [Shared Key] option, enter the WEP key, and then press **OK**.
  - If you selected the [WPA-Personal] option, press **▲** or **▼** to select the Encryption Type [TKIP+AES] or [AES], and then press **OK**.

---

Enter the WPA™ key, and then press **OK**.

- If you selected the [WPA3-SAE] option, select the Encryption Type [AES], and then press **OK**.

Enter the WPA™ key, and then press **OK**.



---

Your Brother machine supports the use of the first WEP key only.

---

10. To apply the settings, select [Yes].

11. The machine will attempt to connect to the wireless device you have selected.

If your wireless device is connected successfully, the machine's LCD displays [Connected].

You have completed the wireless network setup. To install the drivers and software necessary to use your machine, go to your model's **Downloads** page at [support.brother.com/downloads](http://support.brother.com/downloads).



## Related Information

- [Use the Wireless Network](#)

### Related Topics:

- [I Cannot Complete the Wireless Network Setup Configuration](#)
  - [How to Enter Text on Your Machine](#)
  - [Wireless LAN Report Error Codes](#)
-

## Configure Your Machine for an Enterprise Wireless Network

**Related Models:** HL-L2405W/HL-L2420DW/HL-L2460DW/HL-L2460DWXL/HL-L2865DW

Before configuring your machine, we recommend writing down your wireless network settings. You will need this information before you continue with the configuration.

1. Check and record the current wireless network settings.

Network Name (SSID)

Authentication Method	Encryption Mode	User ID	Password
EAP-FAST/NONE	AES		
	TKIP		
EAP-FAST/MS-CHAPv2	AES		
	TKIP		
EAP-FAST/GTC	AES		
	TKIP		
PEAP/MS-CHAPv2	AES		
	TKIP		
PEAP/GTC	AES		
	TKIP		
EAP-TTLS/CHAP	AES		
	TKIP		
EAP-TTLS/MS-CHAP	AES		
	TKIP		
EAP-TTLS/MS-CHAPv2	AES		
	TKIP		
EAP-TTLS/PAP	AES		
	TKIP		
EAP-TLS	AES		-
	TKIP		-

For example:

Network Name (SSID)
HELLO

Authentication Method	Encryption Mode	User ID	Password
EAP-FAST/MS-CHAPv2	AES	Brother	12345678



- If you configure your machine using EAP-TLS authentication, you must install the client certificate issued by a CA before you start configuration. Contact your network administrator about the client certificate. If you have installed more than one certificate, we recommend writing down the certificate name you want to use.
- If you verify your machine using the common name of the server certificate, we recommend writing down the common name before you start configuration. Contact your network administrator about the common name of the server certificate.

2. Press ▲ or ▼ to select the [Network] option, and then press **OK**.
3. Press ▲ or ▼ to select the [WLAN (Wi-Fi)] option, and then press **OK**.
4. Press ▲ or ▼ to select the [Find Network] option, and then press **OK**.
5. When [WLAN Enable?] appears, select On.  
This will start the wireless setup wizard.
6. The machine will search for your network and display a list of available SSIDs. Press ▲ or ▼ to select the [<New SSID>] option, and then press **OK**.
7. Enter the SSID name, and then press **OK**.
8. Press ▲ or ▼ to select the Authentication Method you want, and then press **OK**.
9. Do one of the following:
  - If you selected the [EAP-FAST], [PEAP] or [EAP-TTLS] option, press ▲ or ▼ to select the Inner Authentication Method [NONE], [CHAP], [MS-CHAP], [MS-CHAPv2], [PAP] or [GTC], and then press **OK**.



Depending on your Authentication Method, the Inner Authentication Method selections differ.

Press ▲ or ▼ to select the Encryption Type [TKIP+AES] or [AES], and then press **OK**.

Press ▲ or ▼ to select the Verification Method [No Verification], [CA] or [CA+Server ID], and then press **OK**.

- If you selected the [CA+Server ID] option, enter the server ID, user ID and password (if required), and then press **OK** for each option.
- For other selections, enter the user ID and the Password, and then press **OK** for each option.



If you have not imported a CA certificate into your machine, the machine will display the message [No Verification].

- If you selected the [EAP-TLS] option, press ▲ or ▼ to select the Encryption Type [TKIP+AES] or [AES], and then press **OK**.  
When the machine displays a list of available Client Certificates, select the certificate you want.  
Press ▲ or ▼ to select the Verification Method [No Verification], [CA] or [CA+Server ID], and then press **OK**.
  - If you selected the [CA+Server ID] option, enter the server ID and user ID, and then press **OK** for each option.
  - For other selections, enter the user ID, and then press **OK**.

10. To apply the settings, press ▲. To cancel, press ▼.

11. The machine will attempt to connect to the wireless device you have selected.

If your wireless device is connected successfully, the machine's LCD displays [Connected].

You have completed the wireless network setup. To install the drivers or the application necessary for operating your machine, go to your model's **Downloads** page at [support.brother.com/downloads](http://support.brother.com/downloads).



## Related Information

- [Use the Wireless Network](#)



---

**Related Topics:**

- [Wireless LAN Report Error Codes](#)
-

## Use Wi-Fi Direct®

**Related Models:** HL-L2405W/HL-L2420DW/HL-L2460DW/HL-L2460DWXL/HL-L2865DW

- [Wi-Fi Direct Overview](#)
- [Configure Your Wi-Fi Direct Network Manually](#)
- [Configure Wi-Fi Direct Network Using the Push Button Method](#)

## Wi-Fi Direct Overview

**Related Models:** HL-L2405W/HL-L2420DW/HL-L2460DW/HL-L2460DWXL/HL-L2865DW

Wi-Fi Direct is one of the wireless configuration methods developed by the Wi-Fi Alliance®. It allows you to securely connect your mobile device to your machine without using a wireless router/access point.

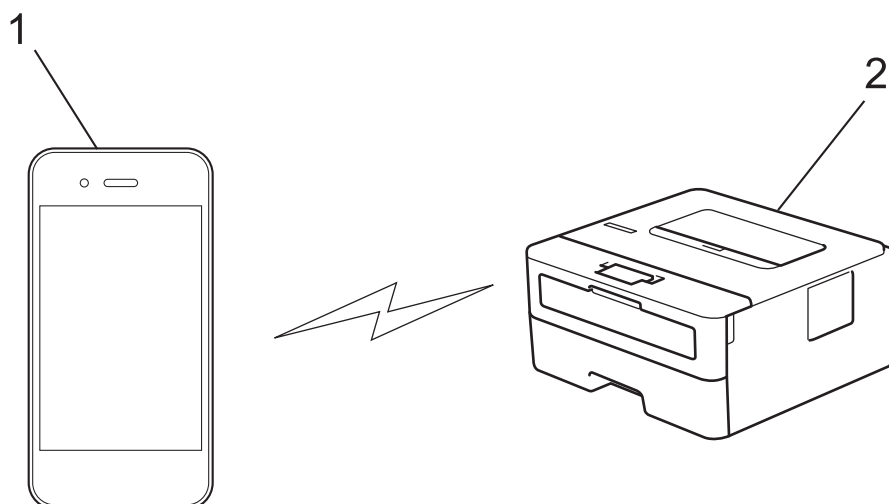

1. Mobile device
2. Your machine



- You can use Wi-Fi Direct with the wired or wireless network connection at the same time.
- The Wi-Fi Direct-supported device can become a Group Owner. When configuring the Wi-Fi Direct network, the Group Owner serves as an access point.

### ✓ Related Information

- [Use Wi-Fi Direct®](#)

#### Related Topics:

- [Configure Your Wi-Fi Direct Network Manually](#)
- [Configure Wi-Fi Direct Network Using the Push Button Method](#)

## Configure Your Wi-Fi Direct Network Manually

**Related Models:** HL-L2405W/HL-L2420DW/HL-L2460DW/HL-L2460DWXL/HL-L2865DW

If your mobile device does not support Wi-Fi Direct or WPS, you must configure a Wi-Fi Direct network manually.

1. Press ▲ or ▼ to select the [Network] option, and then press **OK**.
2. Press ▲ or ▼ to select the [Wi-Fi Direct] option, and then press **OK**.
3. Press ▲ or ▼ to select the [Manual] option, and then press **OK**.
4. When [Wi-Fi Direct On?] appears, select On.
5. The machine will display the SSID name and Password. Go to your mobile device's wireless network settings screen, select the SSID name, and then enter the password.
6. If your mobile device connects successfully, the machine's LCD displays [Connected]. You have completed the Wi-Fi Direct network setup.

### ✓ Related Information

- [Use Wi-Fi Direct®](#)

#### **Related Topics:**

- [Wi-Fi Direct Overview](#)
- [Configure Wi-Fi Direct Network Using the Push Button Method](#)

## Configure Wi-Fi Direct Network Using the Push Button Method

**Related Models:** HL-L2405W/HL-L2420DW/HL-L2460DW/HL-L2460DWXL/HL-L2865DW

If your mobile device supports Wi-Fi Direct, follow these steps to configure a Wi-Fi Direct network:

1. Press ▲ or ▼ to select the [Network] option, and then press **OK**.
2. Press ▲ or ▼ to select the [Wi-Fi Direct] option, and then press **OK**.
3. Press ▲ or ▼ to select the [Push Button] option, and then press **OK**.
4. When [Wi-Fi Direct On?] appears, select On.



If your mobile device does not support Wi-Fi Direct, do the following:

- a. Press ▲ or ▼ to select the [Network] option, and then press **OK**.
  - b. Press ▲ or ▼ to select the [Wi-Fi Direct] option, and then press **OK**.
  - c. Press ▲ or ▼ to select the [Group Owner] option, and then press **OK**.
  - d. Press ▲ or ▼ to select the [On] option, and then press **OK**.
  - e. Press ▲ or ▼ to select the [Push Button] option, and then press **OK**.
5. Activate Wi-Fi Direct on your mobile device (see your mobile device's user's guide for instructions) when [Activate Wi-Fi Direct on other device and press OK.] appears on the machine's LCD. Press **OK** on your machine.  
This will start the Wi-Fi Direct setup.
  6. Do one of the following:
    - If your mobile device displays a list of machines with Wi-Fi Direct enabled, select your Brother machine.
    - If your Brother machine displays a list of mobile devices with Wi-Fi Direct enabled, select your mobile device. Press ▲ or ▼ to select the mobile device you want to connect to and press **OK**. To search for available devices again, select [<Rescan>], and then press **OK**.
  7. If your mobile device connects successfully, the machine's LCD displays [Connected]. You have completed the Wi-Fi Direct network setup.



### Related Information

- [Use Wi-Fi Direct®](#)

#### Related Topics:

- [Wi-Fi Direct Overview](#)
- [Configure Your Wi-Fi Direct Network Manually](#)

## Enable/Disable Wireless LAN

**Related Models:** HL-L2405W/HL-L2420DW/HL-L2460DW/HL-L2460DWXL/HL-L2865DW

1. Press ▲ or ▼ to select the [Network] option, and then press **OK**.
2. Press ▲ or ▼ to select the [WLAN (Wi-Fi)] option, and then press **OK**.
3. Press ▲ or ▼ to select the [WLAN Enable] option, and then press **OK**.
4. Do one of the following:
  - To enable Wi-Fi, select [On].
  - To disable Wi-Fi, select [Off].
5. Press **Go**.



### Related Information

- [Wireless Network Settings](#)

## Print the WLAN Report

**Related Models:** HL-L2405W/HL-L2420DW/HL-L2460DW/HL-L2460DWXL/HL-L2865DW

The WLAN Report shows your machine's wireless status. If the wireless connection fails, check the error code on the printed report.

1. Press ▲ or ▼ to select the [Print Reports] option, and then press **OK**.
2. Press ▲ or ▼ to select the [WLAN Report] option, and then press **OK**.
3. Press **Go**.

The machine will print the WLAN Report.



### Related Information

- [Wireless Network Settings](#)
  - [Wireless LAN Report Error Codes](#)

#### Related Topics:

- [My Machine Cannot Print over the Network](#)
- [I Want to Check that My Network Devices are Working Correctly](#)

## Wireless LAN Report Error Codes

**Related Models:** HL-L2405W/HL-L2420DW/HL-L2460DW/HL-L2460DWXL/HL-L2865DW

If the Wireless LAN Report shows that the connection failed, check the error code on the printed report and see the corresponding instructions in the table:

Error Code	Problem and Recommended Solutions
TS-01	<p>The WLAN (Wi-Fi) is not enabled.</p> <p>Check the following points and try to set up your wireless connection again:</p> <ul style="list-style-type: none"><li>• Enable the WLAN setting on your machine.</li><li>• If a network cable is connected to your machine, disconnect it.</li></ul>
TS-02	<p>The wireless router/access point cannot be detected.</p> <p>Check the following points and try to set up your wireless connection again:</p> <ul style="list-style-type: none"><li>• Make sure the wireless router/access point is on.</li><li>• Temporarily place your machine closer to the wireless router/access point when you are configuring the wireless settings.</li><li>• If your wireless router/access point is using MAC address filtering, confirm that the MAC address of the machine is allowed in the filter. You can find the MAC address by printing the Network Configuration Report.</li><li>• If you manually entered the Network Name (SSID) and security information (authentication method/encryption method), the information may be incorrect. Check the Network Name and security information again and re-enter the correct information.</li><li>• Restart your wireless router/access point. If you cannot find the Network Name (SSID) and security information, see the documentation provided with your wireless router/access point, or contact the router manufacturer, your system administrator, or Internet service provider.</li></ul>
TS-03	<p>The wireless enterprise network and security settings you entered may be incorrect.</p> <p>Check the following points and try to set up your wireless connection again:</p> <p>Verify the following information:</p> <ul style="list-style-type: none"><li>- Network Name (SSID) you selected to configure your machine.</li><li>- Security information you selected to configure your machine (such as the authentication method, encryption method, or User ID).</li></ul> <p>If you still cannot find the Network Name (SSID) and security information, see the documentation provided with your wireless router/access point, or contact the router manufacturer, your system administrator, or Internet service provider.</p>



Error Code	Problem and Recommended Solutions
TS-04	<p>Your machine does not support the authentication and encryption methods used by the selected wireless router/access point.</p> <p>For infrastructure mode (Most common)</p> <p>Change the authentication and encryption methods of the wireless router/access point. Your machine supports the following authentication and encryption methods:</p> <ul style="list-style-type: none"> <li>• WPA-Personal: TKIP / AES</li> <li>• WPA2-Personal: TKIP / AES</li> <li>• WPA3-Personal: AES</li> <li>• OPEN: WEP / NONE (without encryption)</li> <li>• Shared key: WEP</li> </ul> <p>If your issue is not solved, the Network Name (SSID) or security settings you entered may be incorrect. Check that all wireless network settings are correct for your network.</p>
TS-05	<p>The Network Name (SSID) and Network Key (Password) are incorrect.</p> <p>Check the following points and try to set up your wireless connection again:</p> <ul style="list-style-type: none"> <li>• Confirm the Network Name (SSID) and Network Key (Password).</li> <li>• If your Network Key contains upper-case and lower-case letters, make sure you type them correctly.</li> <li>• If you cannot find the Network Name (SSID) and security information, see the documentation provided with your wireless router/access point, or contact the router manufacturer, your system administrator, or Internet service provider.</li> <li>• If your wireless router/access point uses WEP encryption with multiple WEP keys, write down and use only the first WEP key.</li> </ul>
TS-06	<p>The wireless security information (authentication method/encryption method/Network Key (Password)) is incorrect.</p> <p>Check the following points and try to set up your wireless connection again:</p> <ul style="list-style-type: none"> <li>• Confirm the Network Key. If your Network Key contains upper-case and lower-case letters, make sure you type them correctly.</li> <li>• Confirm whether the authentication method entered and the authentication method or encryption method supported by the wireless router/access point are the same.</li> <li>• If the network key, authentication method, and encryption method have been confirmed, restart your wireless router/access point and the machine.</li> <li>• If your wireless router/access point's Stealth Mode is on, you may need to disable it to connect to the wireless network.</li> </ul> <p>If you cannot find the Network Name (SSID) and security information, see the documentation provided with your wireless router/access point, or contact the router manufacturer, your system administrator, or Internet service provider.</p>
TS-07	<p>The machine cannot detect a wireless router/access point that has WPS (Wi-Fi Protected Setup) enabled.</p> <p>Check the following points and try again:</p> <ul style="list-style-type: none"> <li>• To check if your wireless router/access point supports WPS, look for the WPS symbol displayed on the router/access point. For more information, see the documentation provided with your wireless router/access point.</li> <li>• To set up your wireless connection using WPS, you must configure both your machine and the wireless router/access point. For more information, see the user's guide.</li> <li>• If you do not know how to set up your wireless router/access point using WPS, see the documentation provided with your wireless router/access point, or contact the router manufacturer, your system administrator, or Internet service provider.</li> </ul>

Error Code	Problem and Recommended Solutions
TS-08	<p>Two or more wireless routers or access points that have WPS enabled are detected.</p> <p>Check the following points and try again:</p> <ul style="list-style-type: none"> <li>• Make sure that only one wireless router/access point within range has WPS enabled, and then try to connect again.</li> <li>• Try to connect again after a few minutes to avoid interference from other access points/routers.</li> </ul>



How to confirm wireless security information (SSID/authentication method/encryption method/Network Key) of your WLAN access point/router:

1. The default security settings may be provided on a label attached to the WLAN access point/router. Or the manufacturer's name or model number of the WLAN access point/router may be used as the default security settings.
2. See the documentation provided with your WLAN access point/router for information on how to find the security settings.
  - If the WLAN access point/router is set to not broadcast the SSID, the SSID will not automatically be detected. You will have to manually enter the SSID name.
  - The Network Key may also be described as the Password, Security Key, or Encryption Key.

If you do not know the SSID and wireless security settings of your WLAN access point/router or how to change the configuration, see the documentation provided with your WLAN access point/router, ask the manufacturer of your access point/router or ask your Internet provider or network administrator.



## Related Information

- [Print the WLAN Report](#)

### Related Topics:

- [My Machine Cannot Print over the Network](#)
- [I Want to Check that My Network Devices are Working Correctly](#)
- [Configure Your Machine for a Wireless Network Using the One Push Method of Wi-Fi Protected Setup™ \(WPS\)](#)
- [Configure Your Machine for a Wireless Network Using the PIN Method of Wi-Fi Protected Setup™ \(WPS\)](#)
- [Configure Your Machine for a Wireless Network Using the Machine's Control Panel Setup Wizard](#)
- [Configure Your Machine for a Wireless Network When the SSID Is Not Broadcast](#)
- [Configure Your Machine for an Enterprise Wireless Network](#)

## Network Features

**Related Models:** HL-L2405W/HL-L2420DW/HL-L2460DW/HL-L2460DWXL/HL-L2865DW

- [Enable/Disable Web Based Management Using the Control Panel](#)
- [Print the Network Configuration Report](#)
- [Reset the Network Settings to the Factory Settings](#)
- [Change Machine Settings Using Web Based Management](#)
- [Print the Network Configuration Report](#)

## Enable/Disable Web Based Management Using the Control Panel

**Related Models:** HL-L2405W/HL-L2420DW/HL-L2460DW/HL-L2460DWXL/HL-L2865DW

1. Press ▲ or ▼ to select the [Network] option, and then press **OK**.
2. Press ▲ or ▼ to select the [Web Based Mgmt] option, and then press **OK**.
3. Press ▲ or ▼ to select the option you want, and then press **OK**.



If you enable this function, make sure you specify the connection method to use Web Based Management.



### Related Information

- [Network Features](#)

#### Related Topics:

- [Print an Email Attachment](#)

## Print the Network Configuration Report

**Related Models:** HL-L2405W/HL-L2420DW/HL-L2460DW/HL-L2460DWXL/HL-L2865DW

The Network Configuration Report lists the network configuration, including the network print server settings.



- The Node Name appears on the Network Configuration Report. The default Node Name is "BRN123456abcdef" for a wired network or "BRW123456abcdef" for a wireless network (where "123456abcdef" is your machine's MAC Address / Ethernet Address.)
- If the IP Address on the Network Configuration Report shows 0.0.0.0, wait for one minute and try printing it again.
- You can find your machine's settings, such as the IP address, subnet mask, node name, and MAC Address on the report, for example:
  - IP address: 192.168.0.5
  - Subnet mask: 255.255.255.0
  - Node name: BRN000ca0000499
  - MAC Address: 00-0c-a0-00-04-99

1. Press **▲** or **▼** to select the [Print Reports] option, and then press **OK**.
2. Press **▲** or **▼** to select the [Network Config] option, and then press **OK**.
3. Press **Go**.

The machine prints the Network Configuration Report.



### Related Information

- [Network Features](#)

#### Related Topics:

- [Check Your Machine's Network Settings](#)
- [Use the Network Connection Repair Tool \(Windows\)](#)
- [Error Messages](#)
- [I Want to Check that My Network Devices are Working Correctly](#)
- [Access Web Based Management](#)

## Reset the Network Settings to the Factory Settings

**Related Models:** HL-L2405W/HL-L2420DW/HL-L2460DW/HL-L2460DWXL/HL-L2865DW

Use your machine's control panel to reset the machine's network settings to its default factory settings. This resets all information except the administrator password.



You can also reset the print server to its factory settings using Web Based Management.

1. Press ▲ or ▼ to select the [Network] option, and then press **OK**.
2. Press ▲ or ▼ to select the [Network Reset] option, and then press **OK**.
3. Follow the machine's instruction to reset the network settings.

The machine will restart.



### Related Information

- [Network Features](#)

#### Related Topics:

- [Reset Functions](#)

## Security

**Related Models:** HL-L2405W/HL-L2420DW/HL-L2460DW/HL-L2460DWXL/HL-L2865DW

- [Before Using Network Security Features](#)
- [Configure Certificates for Device Security](#)
- [Use SSL/TLS](#)
- [Use SNMPv3](#)
- [Use IEEE 802.1x Authentication](#)
- [Send an Email Securely](#)
- [Lock the Machine Settings from the Control Panel](#)
- [Use Global Network Detection Features](#)

## Before Using Network Security Features

**Related Models:** HL-L2405W/HL-L2420DW/HL-L2460DW/HL-L2460DWXL/HL-L2865DW

Your machine employs some of the latest network security and encryption protocols available today. These network features can be integrated into your overall network security plan to help protect your data and prevent unauthorized access to the machine.



We recommend disabling the FTP server and TFTP protocols. Accessing the machine using these protocols is not secure.



### Related Information

- [Security](#)
  - [Disable Unnecessary Protocols](#)



## Disable Unnecessary Protocols

**Related Models:** HL-L2405W/HL-L2420DW/HL-L2460DW/HL-L2460DWXL/HL-L2865DW

1. Start your web browser.
2. Type "https://machine's IP address" in your browser's address bar (where "machine's IP address" is your machine's IP address).  
For example:  
https://192.168.1.2
3. If required, type the password in the **Login** field, and then click **Login**.



The default password to manage this machine's settings is located on the back of the machine and marked "Pwd". Change the default password by following the on-screen instructions when you first log in.

4. In the left navigation bar, click **Network > Network > Protocol**.



If the left navigation bar is not visible, start navigating from ☰.

5. Clear any unnecessary protocol checkboxes to disable them.
6. Click **Submit**.
7. Restart your Brother machine to activate the configuration.



### Related Information

- [Before Using Network Security Features](#)

## Configure Certificates for Device Security

**Related Models:** HL-L2405W/HL-L2420DW/HL-L2460DW/HL-L2460DWXL/HL-L2865DW

You must configure a certificate to manage your networked machine securely using SSL/TLS. You must use Web Based Management to configure a certificate.

- [Supported Security Certificate Features](#)
- [How to Create and Install a Certificate](#)
- [Create a Self-signed Certificate](#)
- [Create a Certificate Signing Request \(CSR\) and Install a Certificate from a Certificate Authority \(CA\)](#)
- [Import and Export the Certificate and Private Key](#)
- [Import and Export a CA Certificate](#)
- [Manage Multiple Certificates](#)

## Supported Security Certificate Features

**Related Models:** HL-L2405W/HL-L2420DW/HL-L2460DW/HL-L2460DWXL/HL-L2865DW

Your machine supports the use of multiple security certificates, which allows secure management, authentication, and communication with the machine. The following security certificate features can be used with the machine:

- SSL/TLS communication
- SSL communication for SMTP
- IEEE 802.1x authentication

Your machine supports the following:

- Pre-installed certificate

Your machine has a pre-installed self-signed certificate. This certificate enables you to use SSL/TLS communication without creating or installing a different certificate.



The pre-installed self-signed certificate protects your communication up to a certain level. We recommend using a certificate that is issued by a trusted organization for better security.

- Self-signed certificate

This print server issues its own certificate. Using this certificate, you can easily use the SSL/TLS communication without creating or installing a different certificate from a CA.

- Certificate from a Certificate Authority (CA)

There are two methods for installing a certificate from a CA. If you already have a certificate from a CA or if you want to use a certificate from an external trusted CA:

- When using a Certificate Signing Request (CSR) from this print server.
- When importing a certificate and a private key.

- Certificate Authority (CA) Certificate

To use a CA certificate that identifies the CA and owns its private key, you must import that CA certificate from the CA before configuring the security features of the Network.



- If you are going to use SSL/TLS communication, we recommend contacting your system administrator first.
- When you reset the print server back to its default factory settings, the certificate and the private key that are installed will be deleted. If you want to keep the same certificate and the private key after resetting the print server, export them before resetting, and then reinstall them.



### Related Information

- [Configure Certificates for Device Security](#)

## How to Create and Install a Certificate

**Related Models:** HL-L2405W/HL-L2420DW/HL-L2460DW/HL-L2460DWXL/HL-L2865DW

There are two options when choosing a security certificate: use a self-signed certificate or use a certificate from a Certificate Authority (CA).

### Option 1

#### Self-Signed Certificate

1. Create a self-signed certificate using Web Based Management.
2. Install the self-signed certificate on your computer.

### Option 2

#### Certificate from a CA

1. Create a Certificate Signing Request (CSR) using Web Based Management.
2. Install the certificate issued by the CA on your Brother machine using Web Based Management.
3. Install the certificate on your computer.



#### Related Information

- [Configure Certificates for Device Security](#)

## Create a Self-signed Certificate

**Related Models:** HL-L2405W/HL-L2420DW/HL-L2460DW/HL-L2460DWXL/HL-L2865DW

1. Start your web browser.
2. Type "https://machine's IP address" in your browser's address bar (where "machine's IP address" is your machine's IP address).

For example:

https://192.168.1.2



- If you are using a Domain Name System or enable a NetBIOS name, you can type another name, such as "SharedPrinter" instead of the IP address.

For example: https://SharedPrinter

- If you enable a NetBIOS name, you can also use the node name.  
For example: https://brn123456abcdef
- The NetBIOS name can be found in the Network Configuration Report.

3. If required, type the password in the **Login** field, and then click **Login**.



The default password to manage this machine's settings is located on the back of the machine and marked "Pwd". Change the default password by following the on-screen instructions when you first log in.

4. In the left navigation bar, click **Network > Security > Certificate**.



If the left navigation bar is not visible, start navigating from ☰.

5. Click **Create Self-Signed Certificate**.
6. Enter a **Common Name** and a **Valid Date**.
  - The length of the **Common Name** is less than 64 bytes. Enter an identifier, such as an IP address, node name, or domain name to use when accessing this machine through SSL/TLS communication. The node name is displayed by default.
  - A warning will appear if you use the IPPS or HTTPS protocol and enter a different name in the URL than the **Common Name** that was used for the self-signed certificate.
7. Select your setting from the **Public Key Algorithm** drop-down list. The default setting is **EC(256bit)**.
8. Select your setting from the **Digest Algorithm** drop-down list. The default setting is **SHA256**.
9. Click **Submit**.



### Related Information

- [Configure Certificates for Device Security](#)

## Create a Certificate Signing Request (CSR) and Install a Certificate from a Certificate Authority (CA)

**Related Models:** HL-L2405W/HL-L2420DW/HL-L2460DW/HL-L2460DWXL/HL-L2865DW

If you already have a certificate from an external trusted Certificate Authority (CA), you can store the certificate and private key on the machine and manage them by importing and exporting. If you do not have a certificate from an external trusted CA, create a Certificate Signing Request (CSR), send it to a CA for authentication, and install the returned certificate on your machine.

- [Create a Certificate Signing Request \(CSR\)](#)
- [Install a Certificate on Your Machine](#)

## Create a Certificate Signing Request (CSR)

**Related Models:** HL-L2405W/HL-L2420DW/HL-L2460DW/HL-L2460DWXL/HL-L2865DW

A Certificate Signing Request (CSR) is a request sent to a Certificate Authority (CA) to authenticate the credentials contained within the certificate.

We recommend installing a Root Certificate from the CA on your computer before creating the CSR.

1. Start your web browser.
2. Type "https://machine's IP address" in your browser's address bar (where "machine's IP address" is your machine's IP address).

For example:

https://192.168.1.2



- If you are using a Domain Name System or enable a NetBIOS name, you can type another name, such as "SharedPrinter" instead of the IP address.

For example: https://SharedPrinter

- If you enable a NetBIOS name, you can also use the node name.

For example: https://brn123456abcdef

- The NetBIOS name can be found in the Network Configuration Report.

3. If required, type the password in the **Login** field, and then click **Login**.



The default password to manage this machine's settings is located on the back of the machine and marked "**Pwd**". Change the default password by following the on-screen instructions when you first log in.

4. In the left navigation bar, click **Network > Security > Certificate**.



If the left navigation bar is not visible, start navigating from ☰.

5. Click **Create CSR**.
6. Type a **Common Name** (required) and add other information about your **Organization** (optional).



- Your company details are required so that a CA can confirm your identity and verify it to the outside world.
- The length of the **Common Name** must be less than 64 bytes. Enter an identifier, such as an IP address, node name, or domain name to use when accessing this machine through SSL/TLS communication. The node name is displayed by default. The **Common Name** is required.
- A warning will appear if you type a different name in the URL than the Common Name that was used for the certificate.
- The length of the **Organization**, the **Organization Unit**, the **City/Locality**, and the **State/Province** must be less than 64 bytes.
- The **Country/Region** should be a two-character ISO 3166 country code.
- If you are configuring an X.509v3 certificate extension, select the **Configure extended partition** checkbox, and then select **Auto (Register IPv4)** or **Manual**.

7. Select your setting from the **Public Key Algorithm** drop-down list. The default setting is **EC(256bit)**.
8. Select your setting from the **Digest Algorithm** drop-down list. The default setting is **SHA256**.
9. Click **Submit**.

The CSR appears on your screen. Save the CSR as a file or copy and paste it into an online CSR form offered by a Certificate Authority.

---

10. Click **Save**.



- Follow your CA's policy regarding the method to send a CSR to your CA.
  - If you are using the Enterprise root CA of Windows Server 2012/2012 R2/2016/2019/2022, we recommend using the Web Server for the certificate template to securely create the Client Certificate. If you are creating a Client Certificate for an IEEE 802.1x environment with EAP-TLS authentication, we recommend using User for the certificate template.
- 



### **Related Information**

- [Create a Certificate Signing Request \(CSR\) and Install a Certificate from a Certificate Authority \(CA\)](#)
-



## Install a Certificate on Your Machine

**Related Models:** HL-L2405W/HL-L2420DW/HL-L2460DW/HL-L2460DWXL/HL-L2865DW

When you receive a certificate from a Certificate Authority (CA), follow the steps below to install it on the print server:

Only a certificate issued with your machine's Certificate Signing Request (CSR) can be installed on your machine. When you want to create another CSR, make sure that the certificate is installed before creating the new CSR. Create another CSR only after installing the certificate on the machine, otherwise the CSR created before installing the new CSR will be invalid.

1. Start your web browser.
2. Type "https://machine's IP address" in your browser's address bar (where "machine's IP address" is your machine's IP address).

For example:

https://192.168.1.2



- If you are using a Domain Name System or enable a NetBIOS name, you can type another name, such as "SharedPrinter" instead of the IP address.

For example: https://SharedPrinter

- If you enable a NetBIOS name, you can also use the node name.

For example: https://brn123456abcdef

- The NetBIOS name can be found in the Network Configuration Report.

3. If required, type the password in the **Login** field, and then click **Login**.



The default password to manage this machine's settings is located on the back of the machine and marked "Pwd". Change the default password by following the on-screen instructions when you first log in.

4. In the left navigation bar, click **Network > Security > Certificate**.



If the left navigation bar is not visible, start navigating from ☰.

5. Click **Install Certificate**.
6. Browse to the file that contains the certificate issued by the CA, and then click **Submit**.

The certificate has been created and saved in your machine's memory successfully.

To use SSL/TLS communication, the Root Certificate from the CA must be installed on your computer. Contact your network administrator.



### Related Information

- [Create a Certificate Signing Request \(CSR\) and Install a Certificate from a Certificate Authority \(CA\)](#)

## Import and Export the Certificate and Private Key

**Related Models:** HL-L2405W/HL-L2420DW/HL-L2460DW/HL-L2460DWXL/HL-L2865DW

Store the certificate and private key on your machine and manage them by importing and exporting them.

- [Import a Certificate and Private Key](#)
- [Export the Certificate and Private Key](#)

## Import a Certificate and Private Key

**Related Models:** HL-L2405W/HL-L2420DW/HL-L2460DW/HL-L2460DWXL/HL-L2865DW

1. Start your web browser.
2. Type "https://machine's IP address" in your browser's address bar (where "machine's IP address" is your machine's IP address).

For example:

https://192.168.1.2



- If you are using a Domain Name System or enable a NetBIOS name, you can type another name, such as "SharedPrinter" instead of the IP address.

For example: https://SharedPrinter

- If you enable a NetBIOS name, you can also use the node name.  
For example: https://brn123456abcdef
- The NetBIOS name can be found in the Network Configuration Report.

3. If required, type the password in the **Login** field, and then click **Login**.



The default password to manage this machine's settings is located on the back of the machine and marked "Pwd". Change the default password by following the on-screen instructions when you first log in.

4. In the left navigation bar, click **Network > Security > Certificate**.



If the left navigation bar is not visible, start navigating from ☰.

5. Click **Import Certificate and Private Key**.
6. Browse to the file you want to import.
7. Type the password if the file is encrypted, and then click **Submit**.

The certificate and private key are imported to your machine.



### Related Information

- [Import and Export the Certificate and Private Key](#)

## Export the Certificate and Private Key

**Related Models:** HL-L2405W/HL-L2420DW/HL-L2460DW/HL-L2460DWXL/HL-L2865DW

1. Start your web browser.
2. Type "https://machine's IP address" in your browser's address bar (where "machine's IP address" is your machine's IP address).

For example:

https://192.168.1.2



- If you are using a Domain Name System or enable a NetBIOS name, you can type another name, such as "SharedPrinter" instead of the IP address.

For example: https://SharedPrinter

- If you enable a NetBIOS name, you can also use the node name.  
For example: https://brn123456abcdef
- The NetBIOS name can be found in the Network Configuration Report.

3. If required, type the password in the **Login** field, and then click **Login**.



The default password to manage this machine's settings is located on the back of the machine and marked "Pwd". Change the default password by following the on-screen instructions when you first log in.

4. In the left navigation bar, click **Network > Security > Certificate**.



If the left navigation bar is not visible, start navigating from ☰.

5. Click **Export** shown with **Certificate List**.
6. Enter the password if you want to encrypt the file.  
If a blank password is used, the output is not encrypted.
7. Enter the password again for confirmation, and then click **Submit**.
8. Click **Save**.

The certificate and private key are exported to your computer.

You can also import the certificate to your computer.



### Related Information

- [Import and Export the Certificate and Private Key](#)

## Import and Export a CA Certificate

**Related Models:** HL-L2405W/HL-L2420DW/HL-L2460DW/HL-L2460DWXL/HL-L2865DW

You can import, export, and store CA certificates on your Brother machine.

- [Import a CA Certificate](#)
- [Export a CA Certificate](#)

## Import a CA Certificate

**Related Models:** HL-L2405W/HL-L2420DW/HL-L2460DW/HL-L2460DWXL/HL-L2865DW

1. Start your web browser.
2. Type "https://machine's IP address" in your browser's address bar (where "machine's IP address" is your machine's IP address).

For example:

https://192.168.1.2



- If you are using a Domain Name System or enable a NetBIOS name, you can type another name, such as "SharedPrinter" instead of the IP address.

For example: https://SharedPrinter

- If you enable a NetBIOS name, you can also use the node name.  
For example: https://brn123456abcdef
- The NetBIOS name can be found in the Network Configuration Report.

3. If required, type the password in the **Login** field, and then click **Login**.



The default password to manage this machine's settings is located on the back of the machine and marked "**Pwd**". Change the default password by following the on-screen instructions when you first log in.

4. In the left navigation bar, click **Network > Security > CA Certificate**.



If the left navigation bar is not visible, start navigating from ☰.

5. Click **Import CA Certificate**.
6. Browse to the file you want to import.
7. Click **Submit**.



### Related Information

- [Import and Export a CA Certificate](#)

## Export a CA Certificate

**Related Models:** HL-L2405W/HL-L2420DW/HL-L2460DW/HL-L2460DWXL/HL-L2865DW

1. Start your web browser.
2. Type "https://machine's IP address" in your browser's address bar (where "machine's IP address" is your machine's IP address).

For example:

https://192.168.1.2



- If you are using a Domain Name System or enable a NetBIOS name, you can type another name, such as "SharedPrinter" instead of the IP address.

For example: https://SharedPrinter

- If you enable a NetBIOS name, you can also use the node name.  
For example: https://brn123456abcdef
- The NetBIOS name can be found in the Network Configuration Report.

3. If required, type the password in the **Login** field, and then click **Login**.



The default password to manage this machine's settings is located on the back of the machine and marked "Pwd". Change the default password by following the on-screen instructions when you first log in.

4. In the left navigation bar, click **Network > Security > CA Certificate**.



If the left navigation bar is not visible, start navigating from ☰.

5. Select the certificate you want to export and click **Export**.
6. Click **Submit**.



### Related Information

- [Import and Export a CA Certificate](#)

## Manage Multiple Certificates

**Related Models:** HL-L2405W/HL-L2420DW/HL-L2460DW/HL-L2460DWXL/HL-L2865DW

The multiple certificate feature allows you to use Web Based Management to manage each certificate installed on your machine. In Web Based Management, navigate to the **Certificate** or **CA Certificate** screen to view certificate content, delete, or export your certificates.

	Maximum Number of Certificates Stored on Brother Machine
Self-signed Certificate or Certificate Issued by a CA	6
CA Certificate	5

We recommend storing fewer certificates than allowed, reserving an empty spot in case of certificate expiration. When a certificate expires, import a new certificate into the reserved spot, and then delete the expired certificate. This ensures that you avoid configuration failure.



- When you use HTTPS/IPPS, or IEEE 802.1x, you must select which certificate you are using.
- When you use SSL for SMTP communications, you do not have to choose the certificate. The necessary certificate will be chosen automatically.



### Related Information

- [Configure Certificates for Device Security](#)



## Use SSL/TLS

**Related Models:** HL-L2405W/HL-L2420DW/HL-L2460DW/HL-L2460DWXL/HL-L2865DW

- [Introduction to SSL/TLS](#)
- [Manage Your Network Machine Securely Using SSL/TLS](#)
- [Print Documents Securely Using SSL/TLS](#)
- [Send an Email Securely](#)

## Introduction to SSL/TLS

**Related Models:** HL-L2405W/HL-L2420DW/HL-L2460DW/HL-L2460DWXL/HL-L2865DW

Secure Socket Layer (SSL) or Transport Layer Security (TLS) is an effective method of protecting data sent over a local or wide area network (LAN or WAN). It works by encrypting data, such as a print job, sent over a network, so anyone trying to capture it will not be able to read it.

SSL/TLS can be configured on both wired and wireless networks and will work with other forms of security such as WPA keys and firewalls.



### Related Information

- [Use SSL/TLS](#)
  - [Brief History of SSL/TLS](#)
  - [Benefits of Using SSL/TLS](#)

## Brief History of SSL/TLS

**Related Models:** HL-L2405W/HL-L2420DW/HL-L2460DW/HL-L2460DWXL/HL-L2865DW

SSL/TLS was originally created to secure web traffic information, particularly data sent between web browsers and servers. SSL is now used with additional applications, such as Telnet, printer, and FTP software, in order to become a universal solution for online security. Its original design intentions are still being used today by many online retailers and banks to secure sensitive data, such as credit card numbers, customer records, etc.

SSL/TLS uses extremely high levels of encryption and is trusted by banks all over the world.



### Related Information

- [Introduction to SSL/TLS](#)

## Benefits of Using SSL/TLS

**Related Models:** HL-L2405W/HL-L2420DW/HL-L2460DW/HL-L2460DWXL/HL-L2865DW

The primary benefit of using SSL/TLS is to guarantee secure printing over an IP network by restricting unauthorized users from reading data sent to the machine. SSL's most important benefit is that it can be used to print confidential data securely. For example, a Human Resource (HR) Department in a large company may be printing wage slips on a regular basis. Without encryption, the data contained on these wages slips can be read by other network users. However, with SSL/TLS, anyone trying to capture the data will see a page of code and not the actual wage slip.



### Related Information

- [Introduction to SSL/TLS](#)

## Manage Your Network Machine Securely Using SSL/TLS

**Related Models:** HL-L2405W/HL-L2420DW/HL-L2460DW/HL-L2460DWXL/HL-L2865DW

- [Configure a Certificate for SSL/TLS and Available Protocols](#)
- [Access Web Based Management Using SSL/TLS](#)
- [Install the Self-signed Certificate for Windows Users as Administrators](#)
- [Configure Certificates for Device Security](#)

## Configure a Certificate for SSL/TLS and Available Protocols

**Related Models:** HL-L2405W/HL-L2420DW/HL-L2460DW/HL-L2460DWXL/HL-L2865DW

Configure a certificate on your machine using Web Based Management before you use SSL/TLS communication.

1. Start your web browser.
2. Type "https://machine's IP address" in your browser's address bar (where "machine's IP address" is your machine's IP address).

For example:

https://192.168.1.2



- If you are using a Domain Name System or enable a NetBIOS name, you can type another name, such as "SharedPrinter" instead of the IP address.

For example: https://SharedPrinter

- If you enable a NetBIOS name, you can also use the node name.  
For example: https://brn123456abcdef
- The NetBIOS name can be found in the Network Configuration Report.

3. If required, type the password in the **Login** field, and then click **Login**.



The default password to manage this machine's settings is located on the back of the machine and marked "**Pwd**". Change the default password by following the on-screen instructions when you first log in.

4. In the left navigation bar, click **Network > Network > Protocol**.



If the left navigation bar is not visible, start navigating from ☰.

5. Click **HTTP Server Settings**.
6. Select the certificate you want to configure from the **Select the Certificate** drop-down list.
7. Click **Submit**.
8. Click **Yes** to restart your print server.



### Related Information

- [Manage Your Network Machine Securely Using SSL/TLS](#)

## Access Web Based Management Using SSL/TLS

**Related Models:** HL-L2405W/HL-L2420DW/HL-L2460DW/HL-L2460DWXL/HL-L2865DW

To manage your network machine securely, use Web Based Management with the HTTPS protocol.



- To use HTTPS protocol, HTTPS must be enabled on your machine. The HTTPS protocol is enabled by default.
- You can change the HTTPS protocol settings using Web Based Management.

1. Start your web browser.
2. Type "https://Common Name" in your browser's address bar (where "Common Name" is the Common Name that you assigned to the certificate; this could be your IP address, node name, or domain name).
3. If required, type the password in the **Login** field, and then click **Login**.



The default password to manage this machine's settings is located on the back of the machine and marked "**Pwd**". Change the default password by following the on-screen instructions when you first log in.

4. You can now access the machine using HTTPS.



### Related Information

- [Manage Your Network Machine Securely Using SSL/TLS](#)

## Install the Self-signed Certificate for Windows Users as Administrators

**Related Models:** HL-L2405W/HL-L2420DW/HL-L2460DW/HL-L2460DWXL/HL-L2865DW

- The following steps are for Microsoft Edge. If you use another web browser, refer to your web browser's documentation or online help for instructions on how to install certificates.
- Make sure you have created your self-signed certificate using Web Based Management.

1. Right-click the **Microsoft Edge** icon, and then click **Run as administrator**.

If the **User Account Control** screen appears, click **Yes**.

2. Type "https://machine's IP address" in your browser's address bar (where "machine's IP address" is your machine's IP address).

For example:

https://192.168.1.2



- If you are using a Domain Name System or enable a NetBIOS name, you can type another name, such as "SharedPrinter" instead of the IP address.

For example: https://SharedPrinter

- If you enable a NetBIOS name, you can also use the node name.

For example: https://brn123456abcdef

- The NetBIOS name can be found in the Network Configuration Report.

3. If your connection is not private, click the **Advanced** button, and then continue to the web page.

4. If required, type the password in the **Login** field, and then click **Login**.



The default password to manage this machine's settings is located on the back of the machine and marked "**Pwd**". Change the default password by following the on-screen instructions when you first log in.

5. In the left navigation bar, click **Network > Security > Certificate**.



If the left navigation bar is not visible, start navigating from ☰.

6. Click **Export**.

7. To encrypt the output file, type a password in the **Enter password** field. If the **Enter password** field is blank, your output file will not be encrypted.

8. Type the password again in the **Retype password** field, and then click **Submit**.

9. Click the downloaded file to open.

10. When the **Certificate Import Wizard** appears, click **Next**.

11. Click **Next**.

12. If required, type a password, and then click **Next**.

13. Select **Place all certificates in the following store**, and then click **Browse....**

14. Select the **Trusted Root Certification Authorities**, and then click **OK**.

15. Click **Next**.

16. Click **Finish**.

17. Click **Yes**, if the fingerprint (thumbprint) is correct.

18. Click **OK**.



### Related Information

- [Manage Your Network Machine Securely Using SSL/TLS](#)



## Print Documents Securely Using SSL/TLS

**Related Models:** HL-L2405W/HL-L2420DW/HL-L2460DW/HL-L2460DWXL/HL-L2865DW

- [Print Documents Using IPPS](#)
- [Configure a Certificate for SSL/TLS and Available Protocols](#)
- [Configure Certificates for Device Security](#)

## Print Documents Using IPPS

**Related Models:** HL-L2405W/HL-L2420DW/HL-L2460DW/HL-L2460DWXL/HL-L2865DW

To print documents securely with IPP protocol, use the IPPS protocol.

1. Start your web browser.
2. Type "https://machine's IP address" in your browser's address bar (where "machine's IP address" is your machine's IP address).

For example:

https://192.168.1.2



- If you are using a Domain Name System or enable a NetBIOS name, you can type another name, such as "SharedPrinter" instead of the IP address.

For example: https://SharedPrinter

- If you enable a NetBIOS name, you can also use the node name.

For example: https://brn123456abcdef

- The NetBIOS name can be found in the Network Configuration Report.

3. If required, type the password in the **Login** field, and then click **Login**.



The default password to manage this machine's settings is located on the back of the machine and marked "**Pwd**". Change the default password by following the on-screen instructions when you first log in.

4. In the left navigation bar, click **Network > Network > Protocol**.



If the left navigation bar is not visible, start navigating from ☰.

5. Make sure the **IPP** checkbox is selected.



If the **IPP** checkbox is not selected, select the **IPP** checkbox, and then click **Submit**.

Restart your machine to activate the configuration.

After the machine restarts, return to the machine's web page, type the password, and then in the left navigation bar, click **Network > Network > Protocol**.

6. Click **HTTP Server Settings**.
7. Select the **HTTPS** checkbox in the **IPP** area, and then click **Submit**.
8. Restart your machine to activate the configuration.

Communication using IPPS cannot prevent unauthorized access to the print server.



### Related Information

- [Print Documents Securely Using SSL/TLS](#)

## Use SNMPv3

**Related Models:** HL-L2405W/HL-L2420DW/HL-L2460DW/HL-L2460DWXL/HL-L2865DW

- [Manage Your Network Machine Securely Using SNMPv3](#)

## Manage Your Network Machine Securely Using SNMPv3

**Related Models:** HL-L2405W/HL-L2420DW/HL-L2460DW/HL-L2460DWXL/HL-L2865DW

The Simple Network Management Protocol version 3 (SNMPv3) provides user authentication and data encryption to manage network devices securely.

1. Start your web browser.
2. Type "https://Common Name" in your browser's address bar (where "Common Name" is the Common Name that you assigned to the certificate; this could be your IP address, node name, or domain name).
3. If required, type the password in the **Login** field, and then click **Login**.



The default password to manage this machine's settings is located on the back of the machine and marked "Pwd". Change the default password by following the on-screen instructions when you first log in.

4. In the left navigation bar, click **Network > Network > Protocol**.



If the left navigation bar is not visible, start navigating from ☰.

5. Make sure the **SNMP** setting is enabled, and then click **Advanced Settings**.
6. Configure the SNMPv1/v2c mode settings.

Option	Description
<b>SNMP v1/v2c read-write access</b>	The print server uses version 1 and version 2c of the SNMP protocol. You can use all of your machine's applications in this mode. However, it is not secure since it will not authenticate the user and data will not be encrypted.
<b>SNMP v1/v2c read-only access</b>	The print server uses the read-only access of version 1 and version 2c of the SNMP protocol.
<b>Disabled</b>	Disable version 1 and version 2c of the SNMP protocol. All applications that use SNMPv1/v2c will be restricted. To allow the use of SNMPv1/v2c applications, use the <b>SNMP v1/v2c read-only access</b> or <b>SNMP v1/v2c read-write access</b> mode.

7. Configure the SNMPv3 mode settings.

Option	Description
<b>Enabled</b>	The print server uses version 3 of the SNMP protocol. To manage the print server securely, use the SNMPv3 mode.
<b>Disabled</b>	Disable version 3 of the SNMP protocol. All applications that use SNMPv3 will be restricted. To allow the use of SNMPv3 applications, use the SNMPv3 mode.

8. Click **Submit**.



If your machine displays the protocol setting options, select the options you want.

9. Restart your machine to activate the configuration.



### Related Information

- [Use SNMPv3](#)

## Use IEEE 802.1x Authentication

**Related Models:** HL-L2405W/HL-L2420DW/HL-L2460DW/HL-L2460DWXL/HL-L2865DW

- [What Is IEEE 802.1x Authentication?](#)
- [Configure IEEE 802.1x Authentication for a Wired or Wireless Network Using Web Based Management \(Web Browser\)](#)
- [IEEE 802.1x Authentication Methods](#)

## What Is IEEE 802.1x Authentication?

**Related Models:** HL-L2405W/HL-L2420DW/HL-L2460DW/HL-L2460DWXL/HL-L2865DW

IEEE 802.1x is an IEEE standard that limits access from unauthorized network devices. Your Brother machine sends an authentication request to a RADIUS server (Authentication server) through your access point or hub. After your request has been verified by the RADIUS server, your machine can access the network.



### Related Information

- [Use IEEE 802.1x Authentication](#)

## Configure IEEE 802.1x Authentication for a Wired or Wireless Network Using Web Based Management (Web Browser)

**Related Models:** HL-L2405W/HL-L2420DW/HL-L2460DW/HL-L2460DWXL/HL-L2865DW

- If you configure your machine using EAP-TLS authentication, you must install the client certificate issued by a CA before you start configuration. Contact your network administrator about the client certificate. If you have installed more than one certificate, we recommend writing down the certificate name you want to use.
- Before you verify the server certificate, you must import the CA certificate issued by the CA that signed the server certificate. Contact your network administrator or your Internet Service Provider (ISP) to confirm whether a CA certificate import is necessary.



You can also configure IEEE 802.1x authentication using the Wireless Setup Wizard from the control panel (Wireless network).

1. Start your web browser.
2. Type "https://machine's IP address" in your browser's address bar (where "machine's IP address" is your machine's IP address).

For example:

https://192.168.1.2



- If you are using a Domain Name System or enable a NetBIOS name, you can type another name, such as "SharedPrinter" instead of the IP address.

For example: https://SharedPrinter

- If you enable a NetBIOS name, you can also use the node name.

For example: https://brn123456abcdef

- The NetBIOS name can be found in the Network Configuration Report.

3. If required, type the password in the **Login** field, and then click **Login**.



The default password to manage this machine's settings is located on the back of the machine and marked "**Pwd**". Change the default password by following the on-screen instructions when you first log in.

4. In the left navigation bar, click **Network**.



If the left navigation bar is not visible, start navigating from ☰.

5. Do one of the following:
  - For the wired network  
Click **Wired** > **Wired 802.1x Authentication**.
  - For the wireless network  
Click **Wireless** > **Wireless (Enterprise)**.
6. Configure the IEEE 802.1x authentication settings.



- To enable IEEE 802.1x authentication for wired networks, select **Enabled** for **Wired 802.1x status** on the **Wired 802.1x Authentication** page.
- If you are using **EAP-TLS** authentication, you must select the client certificate installed (shown with certificate name) for verification from the **Client Certificate** drop-down list.
- If you select **EAP-FAST**, **PEAP**, **EAP-TTLS**, or **EAP-TLS** authentication, select the verification method from the **Server Certificate Verification** drop-down list. Verify the server certificate using the CA certificate, imported to the machine in advance, issued by the CA that signed the server certificate.

Select one of the following verification methods from the **Server Certificate Verification** drop-down list:

Option	Description
<b>No Verification</b>	The server certificate can always be trusted. The verification is not performed.
<b>CA Cert.</b>	The verification method to check the CA reliability of the server certificate, using the CA certificate issued by the CA that signed the server certificate.
<b>CA Cert. + ServerID</b>	The verification method to check the common name <sup>1</sup> value of the server certificate, in addition to the CA reliability of the server certificate.

7. When finished with configuration, click **Submit**.

For wired networks: After configuring, connect your machine to the IEEE 802.1x supported network. After a few minutes, print the Network Configuration Report to check the **<Wired IEEE 802.1x>** status.

Option	Description
<b>Success</b>	The wired IEEE 802.1x function is enabled and the authentication was successful.
<b>Failed</b>	The wired IEEE 802.1x function is enabled; however, the authentication failed.
<b>Off</b>	The wired IEEE 802.1x function is not available.



## Related Information

- [Use IEEE 802.1x Authentication](#)

### Related Topics:

- [Configure Certificates for Device Security](#)

<sup>1</sup> The common name verification compares the common name of the server certificate to the character string configured for the **Server ID**. Before you use this method, contact your system administrator about the server certificate's common name and then configure **Server ID**.



## IEEE 802.1x Authentication Methods

**Related Models:** HL-L2405W/HL-L2420DW/HL-L2460DW/HL-L2460DWXL/HL-L2865DW

### EAP-FAST

Extensible Authentication Protocol-Flexible Authentication via Secured Tunneling (EAP-FAST) has been developed by Cisco Systems, Inc., which uses a user ID and password for authentication, and symmetric key algorithms to achieve a tunneled authentication process.

Your Brother machine supports the following inner authentication methods:

- EAP-FAST/NONE
- EAP-FAST/MS-CHAPv2
- EAP-FAST/GTC

### EAP-MD5 (Wired network)

Extensible Authentication Protocol-Message Digest Algorithm 5 (EAP-MD5) uses a user ID and password for challenge-response authentication.

### PEAP

Protected Extensible Authentication Protocol (PEAP) is a version of EAP method developed by Cisco Systems, Inc., Microsoft Corporation and RSA Security. PEAP creates an encrypted Secure Sockets Layer (SSL)/Transport Layer Security (TLS) tunnel between a client and an authentication server, for sending a user ID and password. PEAP provides mutual authentication between the server and the client.

Your Brother machine supports the following inner authentication methods:

- PEAP/MS-CHAPv2
- PEAP/GTC

### EAP-TTLS

Extensible Authentication Protocol-Tunneled Transport Layer Security (EAP-TTLS) has been developed by Funk Software and Certicom. EAP-TTLS creates a similar encrypted SSL tunnel to PEAP, between a client and an authentication server, for sending a user ID and password. EAP-TTLS provides mutual authentication between the server and the client.

Your Brother machine supports the following inner authentication methods:

- EAP-TTLS/CHAP
- EAP-TTLS/MS-CHAP
- EAP-TTLS/MS-CHAPv2
- EAP-TTLS/PAP

### EAP-TLS

Extensible Authentication Protocol-Transport Layer Security (EAP-TLS) requires digital certificate authentication both at a client and an authentication server.



### Related Information

- [Use IEEE 802.1x Authentication](#)

## Send an Email Securely

**Related Models:** HL-L2405W/HL-L2420DW/HL-L2460DW/HL-L2460DWXL/HL-L2865DW

- [Configure Email Sending Using Web Based Management](#)
- [Send an Email with User Authentication](#)
- [Send an Email Securely Using SSL/TLS](#)

## Configure Email Sending Using Web Based Management

**Related Models:** HL-L2405W/HL-L2420DW/HL-L2460DW/HL-L2460DWXL/HL-L2865DW

We recommend using Web Based Management to configure secured email sending with user authentication, or email sending using SSL/TLS.

1. Start your web browser.
2. Type "https://machine's IP address" in your browser's address bar (where "machine's IP address" is your machine's IP address).

For example:

https://192.168.1.2

3. If required, type the password in the **Login** field, and then click **Login**.



The default password to manage this machine's settings is located on the back of the machine and marked "**Pwd**". Change the default password by following the on-screen instructions when you first log in.

4. In the left navigation bar, click **Network > Network > Protocol**.



If the left navigation bar is not visible, start navigating from ☰.

5. In the **SMTP Client** field, click **Advanced Settings** and make sure the status of **SMTP Client** is **Enabled**.



If the **Authentication method** selection screen appears, select your authentication method, and then follow the on-screen instructions.

6. Configure the **SMTP Client** settings.
  - Confirm that the email settings are correct after configuration by sending a test email.
  - If you do not know the SMTP server settings, contact your network administrator or Internet Service Provider (ISP).

7. When finished, click **Submit**.

The **Test Send E-mail Configuration** dialog box appears.

8. Follow the instructions in the dialog box to test the current settings.



### Related Information

- [Send an Email Securely](#)

## Send an Email with User Authentication

**Related Models:** HL-L2405W/HL-L2420DW/HL-L2460DW/HL-L2460DWXL/HL-L2865DW

Your machine sends emails via an email server that requires user authentication. This method prevents unauthorized users from accessing the email server.

You can send email notifications and email reports using user authentication.



We recommend using Web Based Management to configure the SMTP authentication.

### Email Server Settings

You must configure your machine's SMTP authentication method to match the method used by your email server. For details about your email server settings, contact your network administrator or Internet Service Provider (ISP).



To enable SMTP server authentication, in the Web Based Management **SMTP Client** screen, under **Server Authentication Method**, you must select your authentication method.



### Related Information

- [Send an Email Securely](#)

## Send an Email Securely Using SSL/TLS

**Related Models:** HL-L2405W/HL-L2420DW/HL-L2460DW/HL-L2460DWXL/HL-L2865DW

Your machine supports SSL/TLS communication methods. To use an email server that is using SSL/TLS communication, you must configure the following settings.



We recommend using Web Based Management to configure SSL/TLS.

### Verify Server Certificate

Under **SSL/TLS**, if you choose **SSL** or **TLS**, the **Verify Server Certificate** checkbox will be selected automatically.



- Before you verify the server certificate, you must import the CA certificate issued by the CA that signed the server certificate. Contact your network administrator or your Internet Service Provider (ISP) to confirm if importing a CA certificate is necessary.
- If you do not need to verify the server certificate, clear the **Verify Server Certificate** checkbox.

### Port Number

If you select **SSL**, or **TLS**, the **Port** value will be changed to match the protocol. To change the port number manually, type the port number after you select **SSL/TLS** settings.

You must configure your machine's communication method to match the method used by your email server. For details about your email server settings, contact your network administrator or your ISP.

In most cases, the secured webmail services require the following settings:

SMTP	<b>Port</b>	587
	<b>Server Authentication Method</b>	<b>SMTP-AUTH</b>
	<b>SSL/TLS</b>	<b>TLS</b>



### Related Information

- [Send an Email Securely](#)

#### Related Topics:

- [Configure Certificates for Device Security](#)

## Lock the Machine Settings from the Control Panel

Before turning on the machine's Setting Lock, write down and save your password. If you forget the password, you must reset all passwords stored in the machine by contacting your administrator or Brother Customer Service.

- [Setting Lock Overview](#)

## Setting Lock Overview

**Related Models:** HL-L2405W/HL-L2420DW/HL-L2460DW/HL-L2460DWXL/HL-L2865DW

Use the Setting Lock feature to block unauthorized access to machine settings.

When Setting Lock is set to On, you cannot access the machine settings without entering the password.

- [Set the Setting Lock Password](#)
- [Change the Setting Lock Password](#)
- [Turn On Setting Lock](#)

## Set the Setting Lock Password

**Related Models:** HL-L2405W/HL-L2420DW/HL-L2460DW/HL-L2460DWXL/HL-L2865DW

1. Press ▲ or ▼ to display the [General Setup] option, and then press **OK**.
2. Press ▲ or ▼ to display the [Setting Lock] option, and then press **OK**.
3. Enter a four-digit number for the password.  
To enter each digit, press ▲ or ▼ to select a number, and then press **OK**.
4. When the LCD displays [Verify:], re-enter the password.



### Related Information

- [Setting Lock Overview](#)

#### Related Topics:

- [How to Enter Text on Your Machine](#)



## Change the Setting Lock Password

**Related Models:** HL-L2405W/HL-L2420DW/HL-L2460DW/HL-L2460DWXL/HL-L2865DW

1. Press ▲ or ▼ to display the [General Setup] option, and then press **OK**.
2. Press ▲ or ▼ to display the [Setting Lock] option, and then press **OK**.
3. Press ▲ or ▼ to select the [Set Password] option, and then press **OK**.
4. Enter the current four-digit password.  
To enter each digit, press ▲ or ▼ to select a number, and then press **OK**.
5. Enter a new four-digit password.  
To enter each digit, press ▲ or ▼ to select a number, and then press **OK**.
6. When the LCD displays [Verify:], re-enter the new password.



### Related Information

- [Setting Lock Overview](#)

## Turn On Setting Lock

**Related Models:** HL-L2405W/HL-L2420DW/HL-L2460DW/HL-L2460DWXL/HL-L2865DW

1. Press ▲ or ▼ to display the [General Setup] option, and then press **OK**.
2. Press ▲ or ▼ to display the [Setting Lock] option, and then press **OK**.
3. Press **OK** when the LCD displays [On].
4. Enter the current four-digit password.  
To enter each digit, press ▲ or ▼ to select a number, and then press **OK**.



### Related Information

- [Setting Lock Overview](#)

## Use Global Network Detection Features

When you use your machine on a private network, use the Global Network Detection feature to avoid a risk from unexpected attacks from the global network.

- [Enable Global IP Address Detection](#)
- [Block Communications from the Global Network](#)

## Enable Global IP Address Detection

**Related Models:** HL-L2405W/HL-L2420DW/HL-L2460DW/HL-L2460DWXL/HL-L2865DW

Use this feature to check your machine's IP address. When your machine is assigned to a global IP address, an alert is displayed on the machine.

1. Press ▲ or ▼ to select the [Network] option, and then press **OK**.
2. Press ▲ or ▼ to select the [Global Detect] option, and then press **OK**.
3. Press ▲ or ▼ to select the [Allow Detect] option, and then press **OK**.
4. Press ▲ or ▼ to select [On], and then press **Go**.



### Related Information

- [Use Global Network Detection Features](#)

## Block Communications from the Global Network

**Related Models:** HL-L2405W/HL-L2420DW/HL-L2460DW/HL-L2460DWXL/HL-L2865DW



When you enable this feature, it limits receiving jobs from devices with global IP addresses

1. Press ▲ or ▼ to select the [Network] option, and then press **OK**.
2. Press ▲ or ▼ to select the [Global Detect] option, and then press **OK**.
3. Press ▲ or ▼ to select the [Reject Access] option, and then press **OK**.
4. Press ▲ or ▼ to select [On], and then press **Go**.



### Related Information

- [Use Global Network Detection Features](#)

## Mobile Connect

- [AirPrint](#)
- [Mopria™ Print Service](#)
- [Brother Mobile Connect](#)

## AirPrint

- [AirPrint Overview](#)
- [Before Using AirPrint \(macOS\)](#)
- [Print Using AirPrint](#)

## AirPrint Overview

**Related Models:** HL-L2405W/HL-L2420DW/HL-L2460DW/HL-L2460DWXL/HL-L2865DW

AirPrint is a printing solution for Apple operating systems that allows you to wirelessly print photos, email, web pages, and documents from your iPad, iPhone, iPod touch, and Mac computer without the need to install a driver.

For more information, visit Apple's website.

Use of the Works with Apple badge means that an accessory has been designed to work specifically with the technology identified in the badge and has been certified by the developer to meet Apple performance standards.



### Related Information

- [AirPrint](#)

#### Related Topics:

- [AirPrint Problems](#)



## Before Using AirPrint (macOS)

**Related Models:** HL-L2405W/HL-L2420DW/HL-L2460DW/HL-L2460DWXL/HL-L2865DW

Before printing using macOS, add your machine to the printer list on your Mac computer.

1. Do one of the following:
  - macOS v13  
Select **System Settings** from the Apple menu.
  - macOS v12 and macOS v11  
Select **System Preferences** from the Apple menu.
2. Select **Printers & Scanners**.
3. Do one of the following:
  - macOS v13  
Click **Add Printer, Scanner, or Fax....**
  - macOS v12 and macOS v11  
Click the + icon below the Printers pane on the left.  
The **Add Printer** screen appears.
4. Do one of the following:
  - macOS v13 and macOS v12  
Select your machine, and then select your model's name from the **Use** pop-up menu.
  - macOS v11  
Select your machine, and then select **AirPrint** from the **Use** pop-up menu.
5. Click **Add**.



### Related Information

- [AirPrint](#)



## Print Using AirPrint

- [Print from iPad, iPhone, or iPod touch](#)
- [Print Using AirPrint \(macOS\)](#)

## Print from iPad, iPhone, or iPod touch

**Related Models:** HL-L2405W/HL-L2420DW/HL-L2460DW/HL-L2460DWXL/HL-L2865DW

The procedure used to print may vary by application. Safari is used in the example below.

1. Make sure your machine is turned on.
2. Load the paper in the paper tray and change the paper tray settings on your machine.
3. Use Safari to open the page that you want to print.
4. Tap  or .
5. Tap **Print**.
6. Make sure your machine is selected.
7. If a different machine (or no machine) is selected, tap **Printer**.  
A list of available machines appears.
8. Tap your machine's name in the list.
9. Select the options you want, such as the number of pages to print and 2-sided printing (if supported by your machine).
10. Tap **Print**.



### Related Information

- [Print Using AirPrint](#)

## Print Using AirPrint (macOS)

**Related Models:** HL-L2405W/HL-L2420DW/HL-L2460DW/HL-L2460DWXL/HL-L2865DW

The procedure used to print may vary by application. Safari is used in the example below. Before printing, make sure your machine is in the printer list on your Mac computer.

1. Make sure your machine is turned on.
2. Load the paper in the paper tray and change the paper tray settings on your machine.
3. On your Mac computer, use Safari to open the page that you want to print.
4. Click the **File** menu, and then select **Print**.
5. Make sure your machine is selected. If a different machine (or no machine) is selected, click the **Printer** pop-up menu, and then select your machine.
6. Select the desired options, such as the number of pages to print and 2-sided printing (if supported by your machine).
7. Click **Print**.



### Related Information

- [Print Using AirPrint](#)

#### Related Topics:

- [Before Using AirPrint \(macOS\)](#)

## Mopria™ Print Service

**Related Models:** HL-L2405W/HL-L2420DW/HL-L2460DW/HL-L2460DWXL/HL-L2865DW

Mopria™ Print Service is a print feature on Android™ mobile devices developed by the Mopria Alliance™. With this service, you can connect to the same network as your machine and print without additional setup.

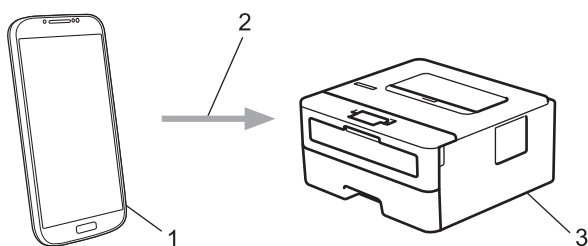

1. Android™ Mobile Device
2. Wi-Fi® Connection
3. Your Machine

You must download the Mopria™ Print Service from Google Play™ and install it on your Android™ device. Before using this Mopria™ feature, make sure you enable it on your mobile device.

### ✓ Related Information

- [Mobile Connect](#)

## Brother Mobile Connect

**Related Models:** HL-L2405W/HL-L2420DW/HL-L2460DW/HL-L2460DWXL/HL-L2865DW

Use Brother Mobile Connect to print from your mobile device.

- For Android™ devices:

Brother Mobile Connect allows you to use your Brother machine's features directly from your Android™ device.

Download and install Brother Mobile Connect from Google Play™.

- For all iOS or iPadOS supported devices including iPhone, iPad, and iPod touch:

Brother Mobile Connect allows you to use your Brother machine's features directly from your iOS or iPadOS device.

Download and install Brother Mobile Connect from the App Store.



### Related Information

- [Mobile Connect](#)

## Troubleshooting

Use this section to resolve typical problems you may encounter when using your machine. You can correct most problems yourself.

### IMPORTANT

For technical help, you must call the country where you bought the machine. Calls must be made from within that country.



If you need additional help, visit [support.brother.com](http://support.brother.com).

First, check the following:

- The machine's power cord is connected correctly and the machine's power is on. See the *Quick Setup Guide*.
- All of the protective materials have been removed. See the *Quick Setup Guide*.
- Paper is loaded correctly in the paper tray.
- The interface cables are securely connected to the machine and the computer, or the wireless connection is set up on both the machine and your computer.
- Error and maintenance messages

If you did not solve the problem with the checks, identify the problem and then see *Related Information*.



### Related Information

- [Error and Maintenance LED Indications](#)
- [Error and Maintenance Messages](#)
- [Paper Jams](#)
- [Printing Problems](#)
- [Improve the Print Quality](#)
- [Network Problems](#)
- [AirPrint Problems](#)
- [Other Problems](#)
- [Check the Machine Information](#)
- [Update Your Machine's Firmware](#)
- [Reset Functions](#)

## Error and Maintenance LED Indications









































**Related Models:** HL-L2400D













As with any sophisticated office product, errors may occur and supply items may have to be replaced. If this happens, your machine identifies the error or required routine maintenance and the Status Monitor indicates the appropriate message. The most common error and maintenance indications are shown in the table.





Follow the instructions in the Actions to improve the status.

LED Indication	Status Monitor	Cause	Action
<p>Toner Drum Paper Ready</p>	<b>Cannot Detect</b>	Your machine cannot detect the toner cartridge.	Remove the toner cartridge and drum unit assembly. Remove the toner cartridge from the drum unit, and reinstall the toner cartridge back in the drum unit. Reinstall the toner cartridge and drum unit assembly back in the machine. <i>See Related Information: Replace the Toner Cartridge.</i>
		Your machine cannot detect the drum unit.	
	<b>Cartridge Error</b>	The toner cartridge is not installed correctly.	Remove the toner cartridge and drum unit assembly from the machine. Take out the toner cartridge, and put it back in the drum unit again. Reinstall the toner cartridge and drum unit assembly back in the machine. If the problem continues, contact Brother Customer Service or your local Brother dealer.
	<b>No Toner</b>	The toner cartridge or the toner cartridge and drum unit assembly is not installed correctly.	Remove the toner cartridge and drum unit assembly. Remove the toner cartridge from the drum unit, and reinstall the toner cartridge back in the drum unit. Reinstall the toner cartridge and drum unit assembly back in the machine. If the problem continues, replace the toner cartridge with a new one. <i>See Related Information: Replace the Toner Cartridge.</i>
<p>Toner Drum Paper Ready</p>	<b>Wrong Toner</b>	The toner cartridge installed is not correct for your machine.	Remove the toner cartridge from the drum unit, and install a toner cartridge with the correct supply order number.
	<b>Toner Low</b>	If the Status Monitor shows <b>Toner Low</b> you can still print; however, the machine is telling you that the toner cartridge is near the end of its life.	Order a new toner cartridge now so a replacement toner cartridge will be available when the Status Monitor displays <b>Replace Toner</b> .

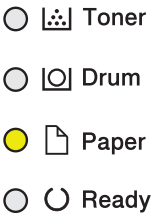

LED Indication	Status Monitor	Cause	Action
  Toner   Drum   Paper   Ready	<b>No Drum Unit</b>	The drum unit is not installed correctly.	Reinstall the toner cartridge and drum unit assembly.  <i>See Related Information: Replace the Drum Unit.</i>
  Toner   Drum   Paper   Ready	<b>Replace Toner</b>	The toner cartridge is at the end of its life.	Replace the toner cartridge with a new one.  <i>See Related Information: Replace the Toner Cartridge.</i>
  Toner   Drum   Paper   Ready	<b>Replace Toner</b> (Continue Mode)		
  Toner   Drum   Paper   Ready	<b>Toner Ended</b> (Continue Mode)	It is time to replace the toner cartridge.	Replace the toner cartridge with a new one.  <i>See Related Information: Replace the Toner Cartridge.</i>
  Toner   Drum   Paper   Ready	<b>Drum !</b>	<p>The corona wire on the drum unit must be cleaned.</p> <p>The drum unit or the toner cartridge and drum unit assembly is not installed correctly.</p>	<p>Clean the corona wire on the drum unit.  <i>See Related Information: Clean the Corona Wire.</i></p> <p>If the problem continues, replace the drum unit with a new one.</p> <p>Remove the toner cartridge and drum unit assembly. Remove the toner cartridge from the drum unit, and reinstall the toner cartridge back into the drum unit. Reinstall the toner cartridge and drum unit assembly into the machine.  If the problem continues, replace the drum unit with a new one.</p>

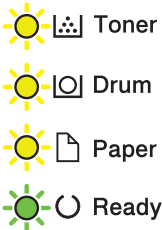
LED Indication	Status Monitor	Cause	Action
 Toner  Drum  Paper  Ready	<b>Drum End Soon</b>	The drum unit is near the end of its life.	Order a new drum unit before the machine displays Replace Drum indication.
 Toner  Drum  Paper  Ready	<b>Replace Drum</b>	It is time to replace the drum unit.	Replace the drum unit with a new one. <i>See Related Information: Replace the Drum Unit.</i>
		If this message appears after replacing the drum unit, the drum unit counter has not been reset.	Reset the drum unit counter. <i>See Related Information: Reset the Drum Counter.</i>
 Toner  Drum  Paper  Ready	<b>Cover is Open</b>	The front cover is not completely closed.	Open and then firmly close the front cover of the machine.
		The fuser cover is not completely closed or paper was jammed in the back of the machine when you turned on the power.	<ul style="list-style-type: none"> <li>Close the fuser cover located inside the back cover of the machine.</li> <li>Make sure paper is not jammed inside the back cover of the machine, and then close the fuser cover.</li> </ul>
	<b>2-sided Disabled</b>	The back cover of the machine is not closed completely.	Close the back cover of the machine until it locks in the closed position.
		The 2-sided tray is not installed completely.	Install the 2-sided tray firmly in the machine.
	<b>Jam 2-sided</b>	The paper is jammed underneath the 2-sided tray or the fuser unit.	Clear the Jam in the 2-sided tray or the fuser unit.
	<b>Jam Inside</b>	The paper is jammed inside the machine.	Open the front cover, remove the drum and toner, and clear the paper jam.
	<b>Jam Rear</b>	The paper is jammed in the back of the machine.	Open the fuser cover and remove all jammed paper. Close the fuser cover.
	<b>Jam Tray 1</b>	The paper is jammed in the paper tray.	Pull the paper tray out completely and remove all jammed paper.
<b>Out of Memory</b>	The machine's memory is full.	Reduce the print resolution.	
<b>Size Error DX</b>	The paper size specified in the printer driver is not suitable for automatic 2-sided printing.	Load the correct size of paper in the tray and set the tray for that paper size.	
	The paper in the tray is not the correct size and is not suitable for automatic 2-sided printing.	The paper sizes suitable for automatic 2-sided printing are Letter, Legal, Mexico Legal, India Legal, and Folio.	

LED Indication	Status Monitor	Cause	Action
	<b>Size Mismatch</b>	The paper in the tray is not the correct size.	Load the correct size of paper in the tray and set the size of paper to the tray. Press <b>Go</b> .
		The paper tray you selected does not support the paper size specified in the printer driver.	Change the printer driver setting or the machine's tray setting so that the paper size selected in the printer driver matches the paper size loaded in the tray you selected.
	<b>Size Error</b>	The paper tray you selected does not support the paper size specified in the printer driver.	Change the printer driver setting or the machine's tray setting so that the paper size selected in the printer driver matches the paper size loaded in the tray you selected.
	<b>Manual Feed</b>	<b>Manual</b> was selected as the paper source in the printer driver, but there is no paper in the manual feed slot.	Place paper in the manual feed slot.
	<b>No Paper T1</b>	The machine is out of paper, or paper is not loaded correctly in the paper trays.	<ul style="list-style-type: none"> <li>• Refill paper in the paper trays. Make sure the paper guides are set to the correct size.</li> <li>• If paper is in the tray, remove it and load it again. Make sure the paper guides are set to the correct size.</li> </ul>
	<b>Cannot Print</b>	The machine has a mechanical problem.	Press and hold  to turn off the machine, wait a few minutes, and then turn it on again.
	<b>Self-Diagnostic</b>	The fuser unit does not work correctly.	Press and hold  to turn off the machine, wait a few seconds, and then turn it on again. Leave the machine idle for 15 minutes with the power on.
		The fuser unit is too hot.	
	<b>Cannot Print</b>	The machine has a mechanical problem.	<ul style="list-style-type: none"> <li>• Press and hold  to turn off the machine, wait a few minutes, and then turn it on again.</li> <li>• If the problem continues, contact Brother Customer Service or your local Brother dealer.</li> </ul> <p>Contact Brother Customer Service at:  1-877-BROTHER  (1-877-276-8437) (in USA)  <a href="http://www.brother.ca/support">www.brother.ca/support</a> (in Canada)</p>

---

LED Indication	Status Monitor	Cause	Action
			or to locate a Brother Authorized Service Center, visit: <a href="http://www.brother-usa.com/support">www.brother-usa.com/support</a>



## Related Information

- [Troubleshooting](#)

### Related Topics:

- [Replace Supplies](#)
  - [Replace the Toner Cartridge](#)
  - [Replace the Drum Unit](#)
  - [Reset the Drum Counter](#)
  - [Clean the Corona Wire](#)
-

## Error and Maintenance Messages

As with any sophisticated office product, errors may occur and supply items may have to be replaced. If this happens, your machine identifies the error or required routine maintenance and shows the appropriate message. The most common error and maintenance messages are shown in the table.

Follow the instructions in the **Action** column to solve the error and remove the message.

You can correct most errors and perform routine maintenance yourself. For more information, visit: [support.brother.com/faqs](http://support.brother.com/faqs).

Error Message	Cause	Action
2-sided Disabled	The back cover of the machine is not closed completely.	Close the back cover of the machine until it locks in the closed position.
	The 2-sided tray is not installed completely.	Install the 2-sided tray firmly in the machine.
Cannot Detect	Your machine cannot detect the toner cartridge.	Remove the toner cartridge and drum unit assembly. Remove the toner cartridge from the drum unit, and reinstall the toner cartridge back in the drum unit. Reinstall the toner cartridge and drum unit assembly back in the machine. <i>See Related Information: Replace the Toner Cartridge.</i>
	Your machine cannot detect the drum unit.	
Cannot Print ##	The machine has a mechanical problem.	<ul style="list-style-type: none"> <li>Press and hold  to turn off the machine, wait a few minutes, and then turn it on again.</li> <li>If the problem continues, contact Brother Customer Service or your local Brother dealer.</li> </ul> <p>Contact Brother Customer Service at: 1-877-BROTHER (1-877-276-8437) (in USA) <a href="http://www.brother.ca/support">www.brother.ca/support</a> (in Canada) or to locate a Brother Authorized Service Center, visit: <a href="http://www.brother-usa.com/support">www.brother-usa.com/support</a></p>
Cartridge Error	The toner cartridge is not installed correctly.	Remove the toner cartridge and drum unit assembly. Take out the toner cartridge, and put it back in the drum unit again. Reinstall the toner cartridge and drum unit assembly in the machine.
Change T1 Paper?	The standard paper tray is not installed or not installed correctly.	Reinstall the standard paper tray.
Cooling Down	The temperature of the inside of the machine is too hot. The machine pauses its current print job and goes into Cooling Down mode.	Wait until the machine has finished cooling down. Make sure all vents on the machine are clear of obstructions. When the machine has cooled down, it will resume printing.
Cover is Open	The front cover is not completely closed.	Open and then firmly close the front cover of the machine.
	The fuser cover is not completely closed.	Close the fuser cover located inside the back cover of the machine.

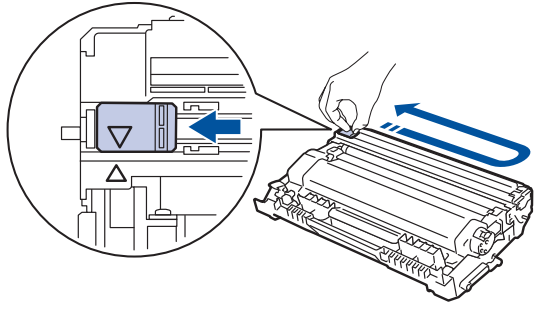
Error Message	Cause	Action
Drum !	The corona wire on the drum unit must be cleaned.	<p>Clean the corona wire on the drum unit.</p>  <p>See <i>Related Information: Clean the Corona Wire</i>.</p> <p>If the problem continues, replace the drum unit with a new one.</p>
	The drum unit or the toner cartridge and drum unit assembly is not installed correctly.	Remove the drum unit, remove the toner cartridge from the drum unit, and put the toner cartridge back into the drum unit. Reinstall the drum unit in the machine.
Drum End Soon	The drum unit is near the end of its life.	Order a new drum unit before the LCD displays <code>Replace Drum</code> .
Jam 2-sided	The paper is jammed in the 2-sided tray or inside the back cover.	Clear the Jam in the 2-sided tray or the fuser unit.
Jam Inside	The paper is jammed inside the machine.	Open the front cover, remove the drum and toner, and clear the paper jam.
Jam Rear	The paper is jammed in the back of the machine.	Open the fuser cover and remove all jammed paper. Close the fuser cover. If the error message remains, press <b>Go</b> .
Jam Tray 1	The paper is jammed in the indicated paper tray.	Pull out the paper tray indicated on the LCD and remove all jammed paper.
Manual Feed	<b>Manual</b> was selected as the paper source in the printer driver, but there is no paper in the manual feed slot.	Place paper in the manual feed slot.
Media Mismatch	The media type specified in the printer driver differs from the paper type specified in the machine's menu.	Load the correct type of paper in the tray indicated on the LCD, and then select the correct media type in the Paper Type setting on the machine. Press <b>Go</b> .
No Drum Unit	The drum unit is not installed correctly.	<p>Reinstall the toner cartridge and drum unit assembly.</p> <p>See <i>Related Information: Replace the Drum Unit</i>.</p>
No Paper	The machine is out of paper, or paper is not loaded correctly in the paper trays.	<ul style="list-style-type: none"> <li>• Refill paper in the paper trays. Make sure the paper guides are set to the correct size.</li> <li>• If paper is in the tray, remove it and load it again. Make sure the paper guides are set to the correct size.</li> <li>• Do not overfill the paper tray.</li> </ul>

Error Message	Cause	Action
No Paper T1	The machine cannot feed paper from the indicated paper tray.	Do one of the following: <ul style="list-style-type: none"> <li>• Refill paper in the paper tray indicated on the LCD. Make sure the paper guides are set to the correct size.</li> <li>• If paper is in the tray, remove it and load it again. Make sure the paper guides are set to the correct size.</li> <li>• Do not overfill the paper tray.</li> </ul>
No Toner	The toner cartridge or the toner cartridge and drum unit assembly is not installed correctly.	Remove the toner cartridge and drum unit assembly. Remove the toner cartridge from the drum unit, and reinstall the toner cartridge back in the drum unit. Reinstall the toner cartridge and drum unit assembly back in the machine. If the problem continues, replace the toner cartridge with a new one. <i>See Related Information: Replace the Toner Cartridge.</i>
Out of Memory	The machine's memory is full.	Press and hold <b>Go</b> for about two seconds and reduce the print resolution.
Replace Drum	It is time to replace the drum unit.	Replace the drum unit with a new one. <i>See Related Information: Replace the Drum Unit.</i>
	If this message appears after replacing the drum unit, the drum unit counter has not been reset.	Reset the drum unit counter. <i>See Related Information: Reset the Drum Counter.</i>
Replace Toner	The toner cartridge is at the end of its life.	Replace the toner cartridge with a new one. <i>See Related Information: Replace the Toner Cartridge.</i>
Self-Diagnostic	The fuser unit does not work correctly.	Press and hold  to turn off the machine, wait a few seconds, and then turn it on again. Leave the machine idle for 15 minutes with the power on.
	The fuser unit is too hot.	
Size Error	The paper tray you selected does not support the paper size specified in the printer driver.	Change the printer driver setting or the machine's tray setting so that the paper size selected in the printer driver matches the paper size loaded in the tray you selected.
Size Error DX	The paper size specified in the machine's paper size setting is not suitable for automatic 2-sided printing.	Load the correct size of paper in the tray and set the tray for that paper size. Choose a paper size suitable for 2-sided printing. Press <b>Go</b> .
	The paper in the tray is not the correct size and is not suitable for automatic 2-sided printing.	The paper sizes suitable for automatic 2-sided printing are Letter, Legal, Mexico Legal, India Legal, and Folio.
Size Mismatch	The paper in the tray is not the correct size.	Load the correct size of paper in the tray indicated on the LCD and set the size of paper for the tray. Press <b>Go</b> .
Toner Ended	It is time to replace the toner cartridge.	Replace the toner cartridge with a new one. <i>See Related Information: Replace the Toner Cartridge.</i>
Toner Low	If the LCD displays this message, you can still print. The toner cartridge is near the end of its life.	Order a new toner cartridge now so you have it ready when the LCD displays <code>Replace Toner</code> .

---

Error Message	Cause	Action
Wrong Toner	The toner cartridge installed is not correct for your machine.	Remove the toner cartridge from the drum unit, and install a toner cartridge with the correct supply order number.



## Related Information

- [Troubleshooting](#)

### Related Topics:

- [Replace Supplies](#)
  - [Replace the Toner Cartridge](#)
  - [Replace the Drum Unit](#)
  - [Reset the Drum Counter](#)
  - [Clean the Corona Wire](#)
-



## Paper Jams

Always remove the remaining paper from the paper tray, fan and straighten the stack when you are adding new paper. This helps prevent paper jams.

- [Clear Paper Jams](#)
- [Paper is Jammed in the Paper Tray](#)
- [Paper is Jammed in the Back of the Machine](#)
- [Paper is Jammed inside the Machine](#)
- [Paper is Jammed in the 2-sided Tray](#)

## Clear Paper Jams

If paper is jammed or multiple sheets of paper are fed together frequently, do the following:

- Clean the paper pick-up rollers and the separator pad of paper trays.  
*See Related Information: Clean the Paper Pick-up Rollers.*
- Load paper correctly in the tray.  
*See Related Information: Load Paper.*
- Set the correct paper size and paper type on your machine.  
*See Related Information: Paper Settings.*
- Set the correct paper size and paper type on your computer.  
*See Related Information: Print a Document (Windows).*  
*See Related Information: Print Using AirPrint.*
- Use the recommended paper.  
*See Related Information: Using Special Paper.*  
*See Related Information: Recommended Print Media.*



### Related Information

- [Paper Jams](#)

#### Related Topics:

- [Clean the Paper Pick-up Rollers](#)
- [Load Paper](#)
- [Paper Settings](#)
- [Print a Document \(Windows\)](#)
- [Print Using AirPrint](#)
- [Using Special Paper](#)
- [Recommended Print Media](#)

## Paper is Jammed in the Paper Tray

If the machine's control panel or the Status Monitor indicates that there is a jam in the paper tray, follow these steps:

1. Pull the paper tray completely out of the machine.

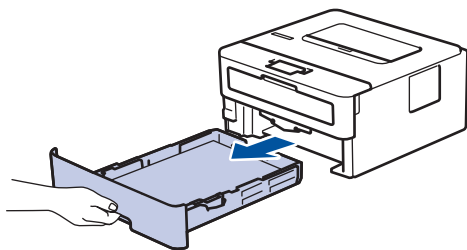

2. Slowly pull out the jammed paper.

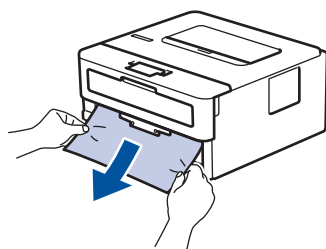

Pulling the jammed paper downward using both hands allows you to remove the paper more easily.

3. Fan the stack of paper to prevent further jams, and slide the paper guides to fit the paper size. Load paper in the paper tray.

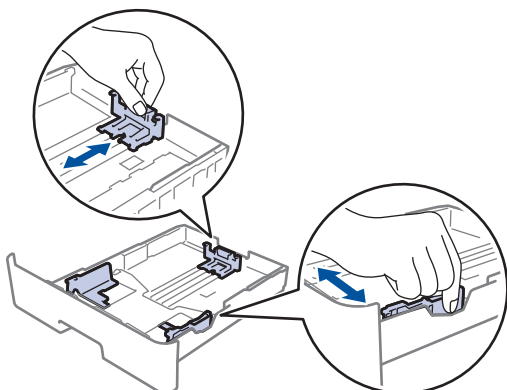

4. Make sure the paper is below the maximum paper mark (▼▼▼).

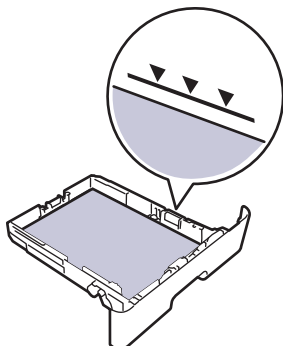

5. Put the paper tray firmly back into the machine.



### Related Information

- [Paper Jams](#)

## Paper is Jammed in the Back of the Machine

If the machine's control panel or the Status Monitor indicates that there is a jam in the back of the machine (Jam Rear), do the following:

1. Leave the machine turned on for 10 minutes for the internal fan to cool the extremely hot parts inside the machine.
2. Open the back cover.

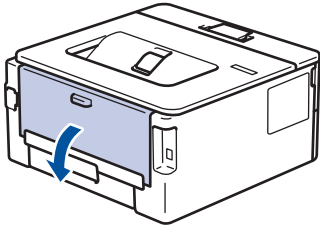

3. Pull the blue tabs at the left and right sides toward you to release the fuser cover.

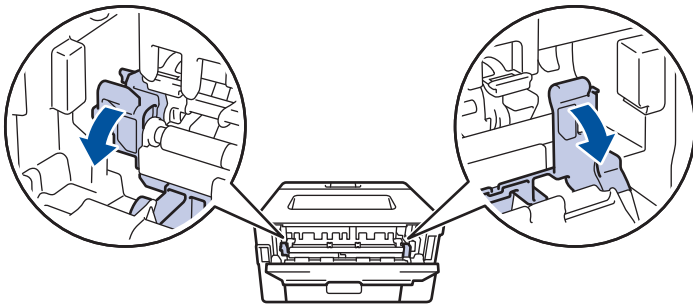

### WARNING

#### HOT SURFACE

The machine's internal parts will be extremely hot. Wait for the machine to cool down before touching them.

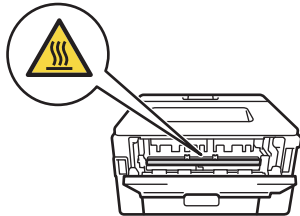

 If the green envelope levers inside the back cover are pulled down to the envelope position, lift these levers to the original position before pulling the blue tabs down.

4. Use both hands to gently pull the jammed paper out of the machine.

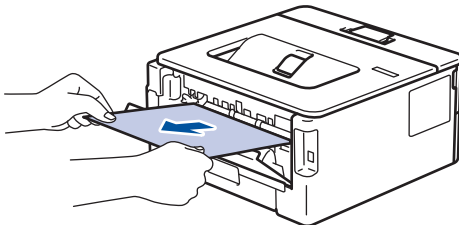

---

5. Close the fuser cover.

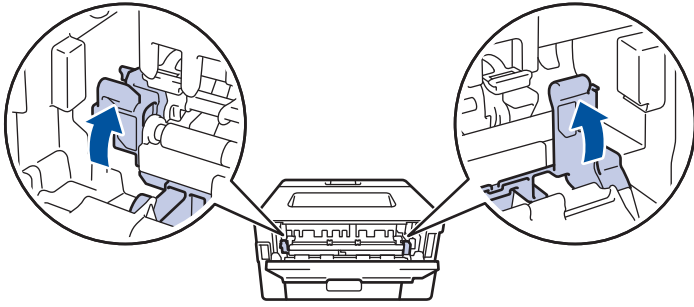

If you print on envelopes, pull down the green envelope levers to the envelope position again before closing the back cover.

---

6. Close the back cover until it locks in the closed position.



### Related Information

- [Paper Jams](#)
-

## Paper is Jammed inside the Machine

If the machine's control panel or the Status Monitor indicates that there is a jam inside the machine, follow these steps:

1. Leave the machine turned on for 10 minutes for the internal fan to cool the extremely hot parts inside the machine.
2. Open the front cover.

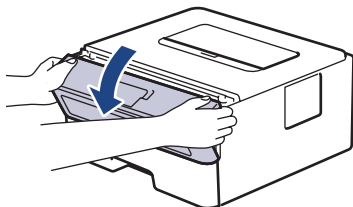

3. Remove the toner cartridge and drum unit assembly.

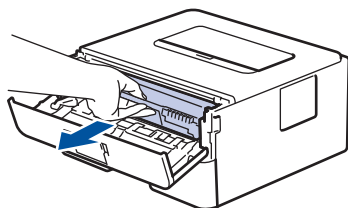

### WARNING

#### HOT SURFACE

The machine's internal parts will be extremely hot. Wait for the machine to cool down before touching them.

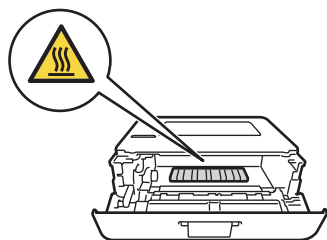

4. Pull out the jammed paper slowly.

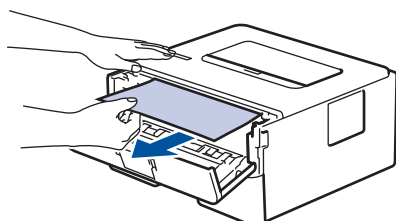

5. Install the toner cartridge and drum unit assembly into the machine.

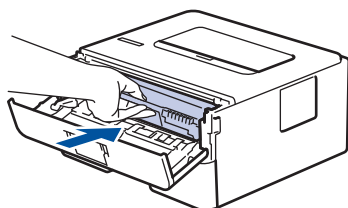

6. Close the front cover.

### Related Information

- [Paper Jams](#)

## Paper is Jammed in the 2-sided Tray

**Related Models:** HL-L2400D/HL-L2420DW/HL-L2460DW/HL-L2460DWXL/HL-L2865DW

If the machine's control panel or the Status Monitor indicates that there is a jam in the 2-sided paper tray, follow these steps:

1. Leave the machine turned on for 10 minutes for the internal fan to cool the extremely hot parts inside the machine.
2. Pull the paper tray completely out of the machine.

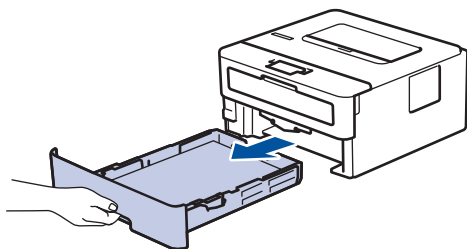

3. At the back of the machine, pull the 2-sided tray completely out of the machine.

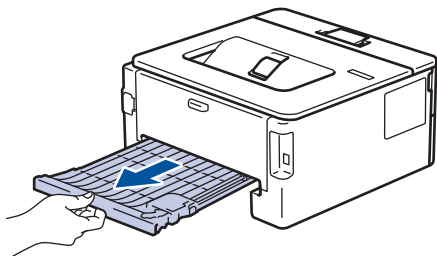

4. Pull the jammed paper out of the machine or out of the 2-sided tray.

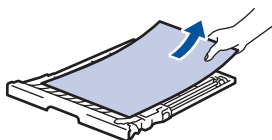
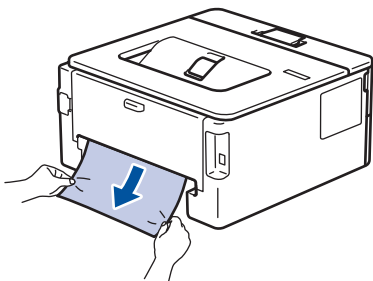

5. Remove paper that may have jammed under the machine due to static electricity.

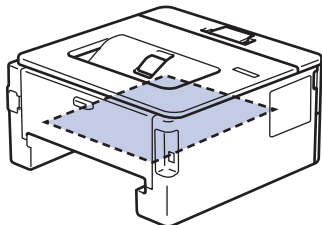

6. If paper is not caught inside the 2-sided tray, open the back cover.

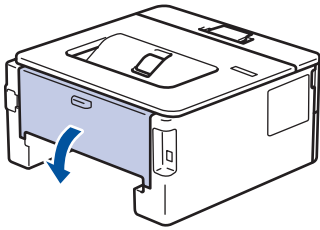

7. Pull the blue tabs at the left and right sides toward you to release the fuser cover.

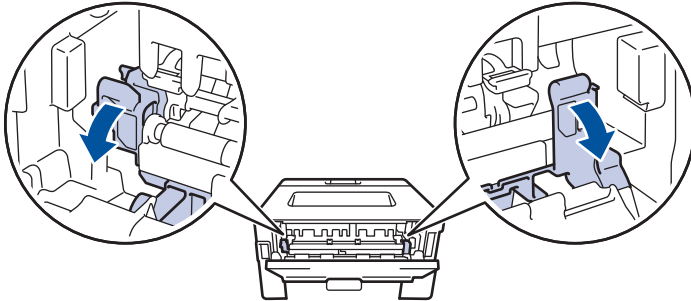

If the green envelope levers inside the back cover are pulled down to the envelope position, lift these levers to the original position before pulling the blue tabs down.

## **⚠ WARNING**

### **HOT SURFACE**

The machine's internal parts will be extremely hot. Wait for the machine to cool down before touching them.



8. Use both hands to gently pull the jammed paper out of the back of the machine.

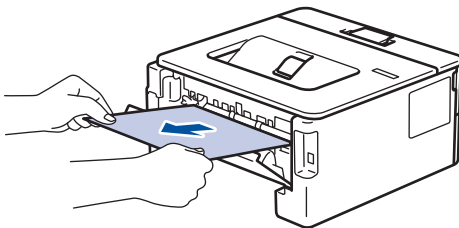

9. Close the fuser cover.

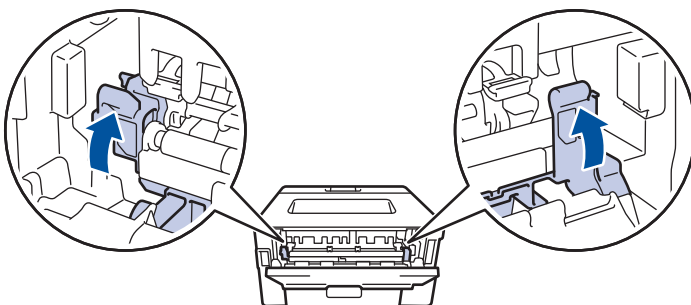

If you print on envelopes, pull down the green envelope levers to the envelope position again before closing the back cover.

10. Close the back cover until it locks in the closed position.



- 
11. Push the 2-sided tray firmly back into the back of the machine.
  12. Push the paper tray firmly back into the front of the machine.





### **Related Information**

- [Paper Jams](#)
-

## Printing Problems

If, after reading the information in this table, you still need help, see the latest troubleshooting tips at [support.brother.com/faqs](http://support.brother.com/faqs).

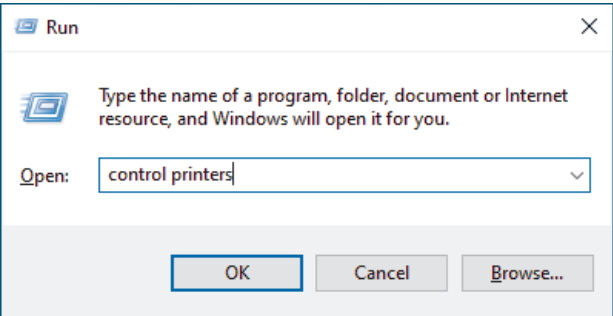
Difficulties	Suggestions
No printout	<p>Check the machine is not in Power Off mode.</p> <p>If the machine is in Power Off mode, press , and then send the print data again.</p> <p>Check that the correct printer driver has been installed and selected.</p> <p>Check to see if the Status Monitor or the machine's control panel displays an error.</p> <p>Check that the machine is online:</p> <p>Windows:</p> <ol style="list-style-type: none"> <li>1. Hold down the  key and press the  key on the computer's keyboard to launch <b>Run</b>.</li> <li>2. Type "<b>control printers</b>" in the <b>Open:</b> field and click <b>OK</b>.</li> </ol>  <ol style="list-style-type: none"> <li>3. Right-click your model's icon, and then click <b>See what's printing</b>.</li> <li>4. If printer driver options appear, select your printer driver.</li> <li>5. Click <b>Printer</b> in the menu bar and make sure <b>Use Printer Offline</b> is not selected.</li> </ol> <p>Mac:</p> <p>Click the <b>System Preferences</b> or <b>System Settings</b> menu, and then select the <b>Printers &amp; Scanners</b> option. When the machine is offline, delete it, and then add it again.</p>
The machine is not printing or has stopped printing.	<p>Cancel the print job and clear it from the machine's memory. The printout may be incomplete. Send the print data again.</p> <p>See <i>Related Information:Cancel a Print Job</i>.</p>
The headers or footers appear when the document displays on the screen but they do not show up when it is printed.	<p>There is an unprintable area on the top and bottom of the page. Adjust the top and bottom margins in your document to allow for this.</p>
The machine prints unexpectedly or it prints garbled text.	<p>Cancel the print job and clear it from the machine's memory. The printout may be incomplete. Send the print data again.</p> <p>See <i>Related Information:Cancel a Print Job</i>.</p> <p>Check the settings in your application to make sure they are set up to work with your machine.</p>

Difficulties	Suggestions
	Confirm that the Brother printer driver is selected in your application's Print window.
The machine prints the first couple of pages correctly, then some pages have missing text.	<p>Check the settings in your application to make sure they are set up to work with your machine.</p> <p>Your machine is not receiving all of the data sent from the computer. Make sure you connected the interface cable correctly.</p>
Cannot print on 1-sided or 2-sided. (HL-L2400D/HL-L2420DW/HL-L2460DW/ HL-L2460DWXL/HL-L2865DW)	<p>(Windows) Change the 2-sided option in the printer driver.</p> <ul style="list-style-type: none"> <li>• If you want to make a temporary change, select <b>None</b> or <b>2-sided</b> in the printer driver from your application: See <i>Related Information: Print a Document (Windows)</i>.</li> <li>• If you want to make a permanent change, change the default printer driver settings: See <i>Related Information: Change the Default Print Settings (Windows)</i>.</li> </ul>
The machine does not print on both sides of the paper even though the printer driver setting is 2-sided and the machine supports automatic 2-sided printing.	Check the paper size setting in the printer driver. You must select Letter, Legal, Folio, Mexico Legal, or India Legal paper. Supported paper weight is 16 to 28 lb (60 to 105g/m <sup>2</sup> ).
Print speed is too slow.	<p>Reduce the resolution in the printer driver.</p> <p>If you have enabled Quiet Mode, disable it in the printer driver or the machine's menu.</p> <p>When printing continuously, the printing speed may be automatically reduced to lower the temperature inside the machine.</p>
The machine does not feed paper.	<p>If there is paper in the paper tray, make sure it is straight. If the paper is curled, straighten it. Sometimes it is helpful to remove the paper, turn the stack over and place it back in the paper tray.</p> <p>Fan the stack of paper well and place it back to the paper tray.</p> <p>Reduce the amount of paper in the paper tray, and then try again.</p> <p>(For models with Manual Feed Slot) Make sure <b>Manual</b> is not selected for <b>Paper Source</b> in the printer driver.</p> <p>Clean the paper pick-up rollers.</p>
The machine does not feed paper from the Manual feed slot. (For models with Manual Feed Slot)	<p>Use both hands to push one sheet of paper firmly into the manual feed slot until the top edge of the paper presses against the paper feed rollers. Continue pressing the paper against the rollers until the machine grabs the paper and pulls it in further.</p> <p>Put only one sheet of paper in the manual feed slot.</p> <p>Make sure <b>Manual</b> is selected as <b>Paper Source</b> in the printer driver.</p>
The machine does not feed envelopes.	Load one envelope at a time in the manual feed slot. Your application must be set to print the envelope size you are using. This is usually done in the Page Setup or Document Setup menu of your application.
Print position is misaligned with the preprinted objects.	Adjust the print position using the Print Position setting for each paper tray.



## Related Information

- [Troubleshooting](#)



### **Related Topics:**



- [Monitor the Status of the Machine from Your Computer \(Windows\)](#)
  - [Cancel a Print Job](#)
  - [Clean the Paper Pick-up Rollers](#)
  - [Change the Default Print Settings \(Windows\)](#)
  - [Print a Document \(Windows\)](#)
-



## Improve the Print Quality

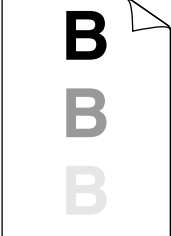
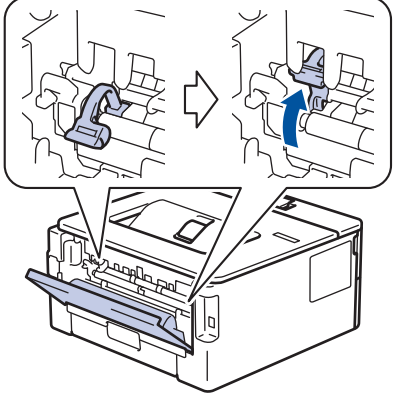

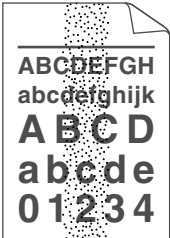
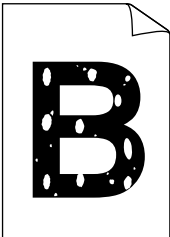
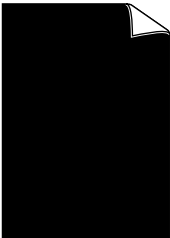
If you have a print quality problem, print a test page first. If the printout looks good, the problem is probably not the machine. Check the interface cable connections and try printing a different document. If the printout or test page printed from the machine has a quality problem, check the examples of poor print quality and follow the recommendations in the table.

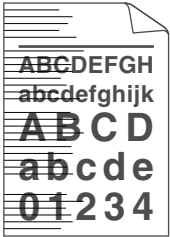
1. To get the best print quality, we suggest using recommended print media. Make sure you use paper that meets our specifications.
2. Check that the toner cartridge and drum unit are installed correctly.

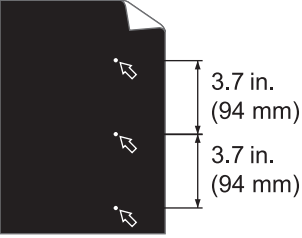
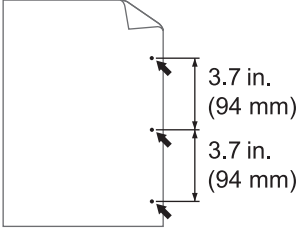
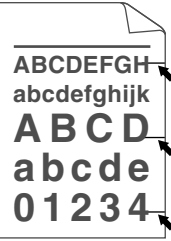
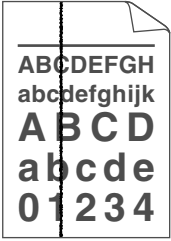

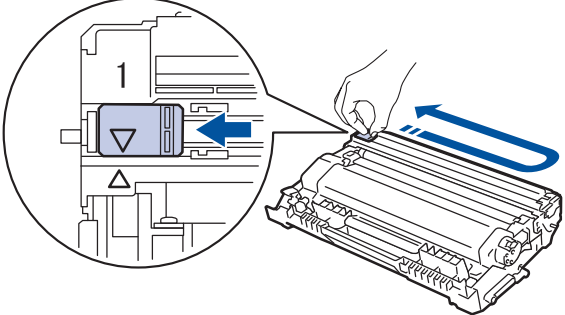
Examples of poor print quality	Recommendation
 <p>ABCDEF GH abcde fghijk A B C D a b c d e 0 1 2 3 4</p> <p>Faint</p>	<ul style="list-style-type: none"> <li>• If the machine displays the Replace Toner status, install a new toner cartridge.</li> <li>• Check the machine's environment. Conditions such as humidity, high temperatures, and so on, may cause this print fault.</li> <li>• If the whole page is too light, Toner Save mode may be turned on. Turn off Toner Save mode in the machine's menu settings or the printer driver.</li> <li>• Clean the drum unit.</li> <li>• Clean the corona wire on the drum unit.</li> <li>• Replace the toner cartridge with a new toner cartridge.</li> <li>• Replace the drum unit with a new drum unit.</li> </ul>
 <p>ABCDEF GH abcde fghijk A B C D a b c d e 0 1 2 3 4</p> <p>Gray background</p>	<ul style="list-style-type: none"> <li>• Check the machine's environment. Conditions such as high temperatures and high humidity can increase the amount of background shading.</li> <li>• Clean the drum unit.</li> <li>• Replace the toner cartridge with a new toner cartridge.</li> <li>• Replace the drum unit with a new drum unit.</li> </ul>
 <p>B B B</p> <p>Ghosting images</p>	<ul style="list-style-type: none"> <li>• Check the machine's environment. Conditions such as low humidity and low temperatures may cause this print quality problem.</li> <li>• Select the appropriate media type in the printer driver.</li> <li>• (For models with an LCD) Select the appropriate media type from the paper type options on your machine.</li> <li>• Make sure the two green levers inside the back cover are in the up position. Pull up the two green levers until they stop.</li> </ul>  <ul style="list-style-type: none"> <li>• Clean the drum unit.</li> <li>• Replace the drum unit with a new drum unit.</li> </ul>

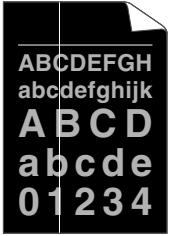
Examples of poor print quality	Recommendation
	<ul style="list-style-type: none"> <li>• Replace the toner cartridge with a new toner cartridge.</li> <li>• The fuser unit may be contaminated. Contact Brother Customer Service. 1-877-BROTHER (1-877-276-8437) (in USA) <a href="http://www.brother.ca/support">www.brother.ca/support</a> (in Canada)</li> </ul>
 <p>Toner specks</p>	<ul style="list-style-type: none"> <li>• Make sure the media type setting in the driver matches the type of paper you are using.</li> <li>• Clean the drum unit.</li> <li>• The toner cartridge may be damaged. Replace the toner cartridge with a new toner cartridge.</li> <li>• The drum unit may be damaged. Replace the drum unit with a new drum unit.</li> <li>• The fuser unit may be contaminated. Contact Brother Customer Service. 1-877-BROTHER (1-877-276-8437) (in USA) <a href="http://www.brother.ca/support">www.brother.ca/support</a> (in Canada)</li> </ul>
 <p>Hollow print</p>	<ul style="list-style-type: none"> <li>• Select <b>Thick Paper</b> mode in the printer driver or use thinner paper than you are currently using.</li> <li>• (For models with an LCD) Select the appropriate media type from the paper type options on your machine.</li> <li>• Check the machine's environment. Conditions such as high humidity can cause hollow print.</li> <li>• The drum unit may be damaged. Replace the drum unit with a new drum unit.</li> </ul>
 <p>All black</p>	<ul style="list-style-type: none"> <li>• Clean the corona wire inside the drum unit.</li> <li>• The drum unit may be damaged. Replace the drum unit with a new drum unit.</li> </ul>
 <p>White lines across the page</p>	<ul style="list-style-type: none"> <li>• Select the appropriate media type in the printer driver.</li> <li>• (For models with an LCD) Select the appropriate media type from the paper type options on your machine.</li> <li>• The problem may disappear by itself. Print several blank pages to clear this problem, especially if the machine has not been used for a long time.</li> <li>• Clean the drum unit.</li> <li>• The drum unit may be damaged. Replace the drum unit with a new drum unit.</li> </ul>
 <p>Lines across the page</p>	<ul style="list-style-type: none"> <li>• Clean the drum unit.</li> <li>• The drum unit may be damaged. Replace the drum unit with a new drum unit.</li> </ul>

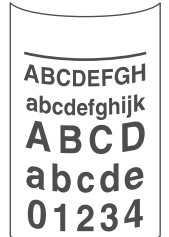
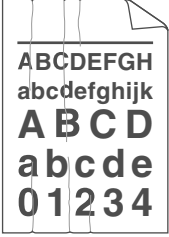
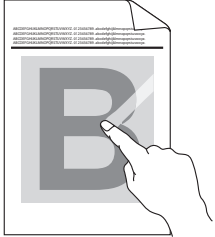
Examples of poor print quality	Recommendation
 <p>White lines, bands or ribbing across the page</p>	<ul style="list-style-type: none"> <li>• Check the machine's environment. Conditions such as high humidity and high temperatures may cause this print quality problem.</li> <li>• Clean the drum unit.</li> <li>• If the problem is not solved after printing a few pages, replace the drum unit with a new drum unit.</li> </ul>
 <p>White spots on black text and graphics at 3.7 in. (94 mm) intervals</p>  <p>Black spots at 3.7 in. (94 mm) intervals</p>	<ul style="list-style-type: none"> <li>• If the problem is not solved after printing a few pages, the drum unit may have foreign material, such as glue from a label, stuck on the drum. Clean the drum unit. <i>See Related Information: Clean the Drum Unit.</i></li> <li>• The drum unit may be damaged. Replace the drum unit with a new drum unit.</li> </ul>
 <p>Black toner marks across the page</p>	<ul style="list-style-type: none"> <li>• If you use label sheets for laser printers, the glue from the sheets may sometimes stick to the drum surface. Clean the drum unit. <i>See Related Information: Clean the Drum Unit.</i></li> <li>• If you used paper that has clips or staples, the drum unit may be damaged.</li> <li>• If the unpacked drum unit is in direct sunlight (or room light for long periods of time), the unit may be damaged.</li> <li>• Clean the drum unit.</li> <li>• The toner cartridge may be damaged. Replace the toner cartridge with a new toner cartridge.</li> <li>• The drum unit may be damaged. Replace the drum unit with a new drum unit.</li> </ul>
 <p>Black lines down the page Printed pages have toner stains down the page</p>	<ul style="list-style-type: none"> <li>• Clean the corona wire inside the drum unit by sliding the green tab.</li> </ul> <p> Make sure the green tab of the corona wire is in the Home position (1).</p>  <ul style="list-style-type: none"> <li>• The toner cartridge may be damaged.</li> </ul>

Examples of poor print quality	Recommendation
	<p>Replace the toner cartridge with a new toner cartridge.</p> <ul style="list-style-type: none"> <li>The drum unit may be damaged.</li> </ul> <p>Replace the drum unit with a new drum unit.</p> <ul style="list-style-type: none"> <li>The fuser unit may be contaminated.</li> </ul> <p>Contact Brother Customer Service. 1-877-BROTHER (1-877-276-8437) (in USA) <a href="http://www.brother.ca/support">www.brother.ca/support</a> (in Canada)</p>
 <p>White lines down the page</p>	<ul style="list-style-type: none"> <li>Make sure there is no foreign material, such as a torn piece of paper, sticky notes or dust, inside the machine and around the toner cartridge and drum unit.</li> <li>The toner cartridge may be damaged. Replace the toner cartridge with a new toner cartridge.</li> <li>The drum unit may be damaged. Replace the drum unit with a new drum unit.</li> </ul>
 <p>Image skewed</p>	<ul style="list-style-type: none"> <li>Make sure the paper or other print media is loaded correctly in the paper tray and the guides are not too tight or too loose against the paper stack.</li> <li>Set the paper guides correctly.</li> <li>The paper tray may be too full.</li> <li>Check the paper type and quality.</li> <li>Check for loose objects such as torn paper inside the machine.</li> <li>If the problem only occurs during automatic 2-sided printing, check for torn paper in the 2-sided tray. Verify the 2-sided tray is inserted completely and the back cover is closed completely.</li> </ul>
 <p>Curled or wavy image</p>	<ul style="list-style-type: none"> <li>Check the paper type and quality. High temperatures and high humidity will cause paper to curl.</li> <li>If you do not use the machine often, the paper may have been in the paper tray too long. Turn over the stack of paper in the paper tray. Also, fan the paper stack, and then rotate the paper 180° in the paper tray.</li> <li>Open the back cover (face up output tray) to let the printed paper exit onto the face up output tray.</li> <li>Choose <b>Reduce Paper Curl</b> mode in the printer driver when you do not use our recommended print media.</li> </ul>
 <p>Wrinkles or creases</p>	<ul style="list-style-type: none"> <li>Make sure paper is loaded correctly.</li> <li>Check the paper type and quality.</li> <li>Turn over the stack of paper in the tray or rotate the paper 180° in the paper tray.</li> </ul>
 <p>Poor fixing</p>	<ul style="list-style-type: none"> <li>Make sure the two green levers inside the back cover are in the up position. Pull up the two green levers until they stop.</li> </ul>

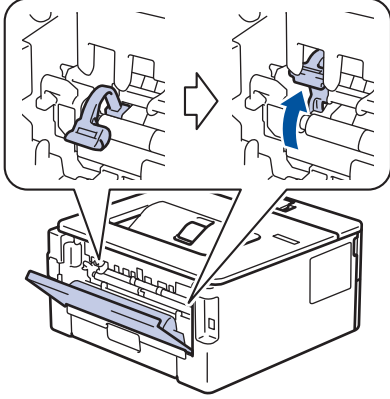

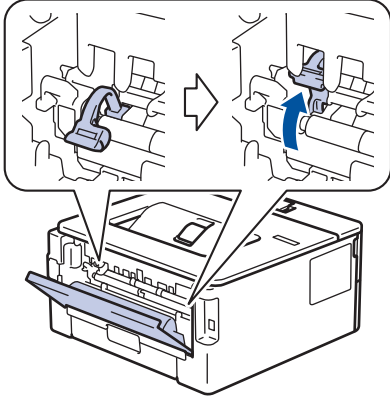
Examples of poor print quality	Recommendation
	 <ul style="list-style-type: none"> <li>• Make sure the media type setting in the printer driver matches the type of paper you are using.</li> <li>• Select <b>Improve Toner Fixing</b> mode in the printer driver.</li> </ul> <p>If this selection does not provide enough improvement, change the printer driver setting in <b>Media Type</b> to a thick setting. If you are printing an envelope, select <b>Env. Thick</b> in the media type setting.</p>
 <p>Envelope creases</p>	<ul style="list-style-type: none"> <li>• Make sure the two green levers inside the back cover are pulled down to the envelope position when you print envelopes. After you have finished printing, reset the levers back to their original position. Pull up the levers until they stop.</li> </ul>  <ul style="list-style-type: none"> <li>• Make sure envelopes are printed with the back cover (face up output tray) opened.</li> <li>• (For models with Manual Feed Slot) Make sure envelopes are fed only from the manual feed slot.</li> </ul>



## Related Information

- [Troubleshooting](#)

### Related Topics:

- [Test Print](#)
- [Clean the Drum Unit](#)
- [Recommended Print Media](#)
- [Reduce Toner Consumption](#)
- [Replace the Toner Cartridge](#)
- [Replace the Drum Unit](#)

## Network Problems

**Related Models:** HL-L2405W/HL-L2420DW/HL-L2460DW/HL-L2460DWXL/HL-L2865DW

- [Error Messages](#)
- [Use the Network Connection Repair Tool \(Windows\)](#)
- [Check Your Machine's Network Settings](#)
- [If You Are Having Difficulty with Your Machine's Network](#)

## Error Messages

**Related Models:** HL-L2405W/HL-L2420DW/HL-L2460DW/HL-L2460DWXL/HL-L2865DW

The most common error messages are shown in the table.

Error Messages	Cause	Action
Maximum limit of connected devices has been reached.	Four mobile devices are already connected to the Wi-Fi Direct network when the Brother machine is the Group Owner.	After the current connection between your Brother machine and another mobile device has shut down, try to configure the Wi-Fi Direct settings again. You can confirm the connection status by printing the Network Configuration Report.
Connection Error	Other devices are trying to connect to the Wi-Fi Direct network at the same time.	Make sure there are no other devices trying to connect to the Wi-Fi Direct network, and then try to configure the Wi-Fi Direct settings again.
Connection Fail	The Brother machine and your mobile device cannot communicate during the Wi-Fi Direct network configuration.	<ul style="list-style-type: none"> <li>• Move the mobile device closer to your Brother machine.</li> <li>• Move your Brother machine and the mobile device to an obstruction-free area.</li> <li>• If you are using the PIN Method of WPS, make sure you have entered the correct PIN.</li> </ul>
No Device	When configuring the Wi-Fi Direct network, the Brother machine cannot find your mobile device.	<ul style="list-style-type: none"> <li>• Make sure your machine and mobile device are in the Wi-Fi Direct mode.</li> <li>• Move the mobile device closer to your Brother machine.</li> <li>• Move your Brother machine and the mobile device to an obstruction-free area.</li> <li>• If you are manually configuring the Wi-Fi Direct network, make sure you have entered the correct password.</li> <li>• If your mobile device has a configuration page for obtaining an IP address, make sure your mobile device's IP address has been configured via DHCP.</li> </ul>



### Related Information

- [Network Problems](#)

#### Related Topics:

- [Print the Network Configuration Report](#)

## Use the Network Connection Repair Tool (Windows)

**Related Models:** HL-L2405W/HL-L2420DW/HL-L2460DW/HL-L2460DWXL/HL-L2865DW

Use the Network Connection Repair Tool to fix the Brother machine's network settings. It will assign the correct IP address and Subnet Mask.

Make sure your machine is turned on and is connected to the same network as your computer.

1. Launch  (**Brother Utilities**), and then click the drop-down list and select your model name (if not already selected).
2. Click **Tools** in the left navigation bar, and then click **Network Connection Repair Tool**.
3. Follow the on-screen instructions.
4. Check the diagnosis by printing the Network Configuration Report or the Printer Settings page.



The Network Connection Repair Tool will start automatically if you select the **Enable Connection Repair Tool** option in the Status Monitor. Right-click the Status Monitor screen, and then click **Other Settings > Enable Connection Repair Tool**. This is not recommended when your network administrator has set the IP address to Static, since it will automatically change the IP address.

If the correct IP address and the Subnet Mask are still not assigned even after using the Network Connection Repair Tool, ask your network administrator for this information.



### Related Information

- [Network Problems](#)

#### Related Topics:

- [Print the Network Configuration Report](#)
- [My Machine Cannot Print over the Network](#)
- [I Want to Check that My Network Devices are Working Correctly](#)

## Check Your Machine's Network Settings

**Related Models:** HL-L2405W/HL-L2420DW/HL-L2460DW/HL-L2460DWXL/HL-L2865DW

- [Print the Network Configuration Report](#)

## If You Are Having Difficulty with Your Machine's Network

If you think there is a problem with your machine's network environment, check the following topics. You can correct most problems yourself.

If you need additional help, visit [support.brother.com/faqs](http://support.brother.com/faqs).

- [I Cannot Complete the Wireless Network Setup Configuration](#)
- [My Machine Cannot Print over the Network](#)
- [I Want to Check that My Network Devices are Working Correctly](#)

## I Cannot Complete the Wireless Network Setup Configuration

**Related Models:** HL-L2405W/HL-L2420DW/HL-L2460DW/HL-L2460DWXL/HL-L2865DW

Turn your wireless router off and back on. Then, try to configure the wireless settings again. If you are unable to resolve the problem, follow the instructions below:

Investigate the problem using the WLAN Report.

Cause	Action	Interface
Your security settings (SSID/ Network Key) are not correct.	<p>Confirm the security settings using <b>Wireless Setup Helper</b> (Windows). For more information and to download the utility, go to your model's <b>Downloads</b> page at <a href="http://support.brother.com/downloads">support.brother.com/downloads</a>.</p> <p>Select and confirm that you are using the correct security settings.</p> <ul style="list-style-type: none"> <li>- See the instructions supplied with your wireless LAN access point/router for information on how to find the security settings.</li> <li>- The manufacturer's name or model number of the wireless LAN access point/router may be used as the default security settings.</li> <li>- Consult with the access point/router manufacturer, your Internet provider, or network administrator.</li> </ul>	Wireless
Your Brother machine's MAC address is not allowed.	<p>Confirm that the Brother machine's MAC Address is allowed in the filter.</p> <p>You can find the MAC Address on your Brother machine's control panel.</p>	Wireless
Your wireless LAN access point/router is in Stealth mode (not broadcasting the SSID).	<ul style="list-style-type: none"> <li>• Enter the correct SSID or Network Key manually.</li> <li>• Check the SSID or the Network Key in the instructions supplied with your wireless LAN access point/router and reconfigure the wireless network setup.</li> </ul>	Wireless
Your machine is trying to connect to a 5 GHz Wi-Fi network. The current channel set on your wireless LAN access point/router is not supported.	<p>Change the channel on your wireless LAN access point/router to a channel supported by your machine.</p> <ol style="list-style-type: none"> <li>1. Confirm the channels supported by your machine. Go to <a href="http://support.brother.com/g/d/a5m6/">support.brother.com/g/d/a5m6/</a>, select your model for more information.</li> <li>2. Check your wireless LAN access point/router's channel setting. Make sure it is set to one of the channels supported by your machine, and not set to "Auto" or "Automatic". For more information about changing the channel setting, see the instructions supplied with your wireless LAN access point/router.</li> <li>3. Try to connect your machine to your Wi-Fi network again.</li> </ol>	Wireless
Your security settings (SSID/ password) are not correct.	<p>Confirm the SSID and password.</p> <p>When you are configuring the network manually, the SSID and password are displayed on your Brother machine. If your mobile device supports the manual configuration, the SSID and password will be displayed on your mobile device's screen.</p>	Wi-Fi Direct
You are using Android™ 4.0.	<p>If your mobile device disconnects (approximately six minutes after using Wi-Fi Direct), try the one-push configuration using WPS (recommended) and set the Brother machine as a Group Owner.</p>	Wi-Fi Direct
Your Brother machine is placed too far from your mobile device.	<p>Move your Brother machine within about 3.3 feet (1 meter) of the mobile device when you configure the Wi-Fi Direct network settings.</p>	Wi-Fi Direct
There are some obstructions (walls or furniture, for example) between your machine and the mobile device.	<p>Move your Brother machine to an obstruction-free area.</p>	Wi-Fi Direct

Cause	Action	Interface
There is a wireless computer, Bluetooth®-supported device, microwave oven, or digital cordless phone near the Brother machine or your mobile device.	Move other devices away from the Brother machine or your mobile device.	Wi-Fi Direct
You have checked and tried all of the above, but your Brother machine still cannot complete the Wi-Fi Direct configuration.	<ul style="list-style-type: none"> <li>• Turn your Brother machine off and back on. Then, try to configure the Wi-Fi Direct settings again.</li> <li>• If you are using your Brother machine as a client, confirm how many devices are allowed on the current Wi-Fi Direct network, and then check how many devices are connected.</li> </ul>	Wi-Fi Direct

### For Windows

If your wireless connection has been interrupted, and you have checked and tried all of the above, we recommend using the Network Connection Repair Tool.



### Related Information

- [If You Are Having Difficulty with Your Machine's Network](#)



#### Related Topics:

- [Configure Your Machine for a Wireless Network When the SSID Is Not Broadcast](#)
- [Use Wi-Fi Direct®](#)



## My Machine Cannot Print over the Network

**Related Models:** HL-L2405W/HL-L2420DW/HL-L2460DW/HL-L2460DWXL/HL-L2865DW

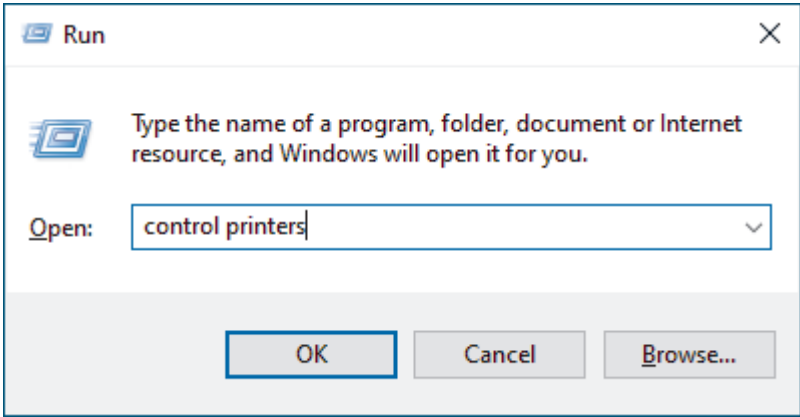
Cause	Action
Your machine disconnects from the wireless network.	HL-L2405W/HL-L2420DW/HL-L2460DW/HL-L2460DWXL/HL-L2865DW 1. Press <b>Wi-Fi</b> . 2. Press ▲ or ▼ to select the <i>Recover WLAN</i> option, and then press <b>OK</b> . 3. When your wireless device connects successfully, the machine displays <i>Connected</i> .
Your security software blocks your machine's access to the network.	Some security software might block access without showing a security alert dialog box even after successful installation. To allow access, see the instructions for your security software or ask the software manufacturer.
Your Brother machine was not assigned an available IP address.	<ul style="list-style-type: none"> <li>Confirm the IP address and the Subnet Mask.                Verify that both the IP addresses and Subnet Masks of your computer and the Brother machine are correct and located on the same network.                For more information about how to verify the IP address and the Subnet Mask, ask your network administrator.</li> <li>Windows                Confirm the IP address and the Subnet Mask using the Network Connection Repair Tool.</li> </ul>
A failed print job is still in your computer's print queue.	<ul style="list-style-type: none"> <li>If a failed print job is still in your computer's print queue, delete it.</li> <li>Otherwise, select the printer icon in the following folder and cancel all documents:                (Windows)               <ol style="list-style-type: none"> <li>Hold down the  key and press the  key on the computer's keyboard to launch <b>Run</b>.</li> <li>Type "<b>control printers</b>" in the <b>Open:</b> field and click <b>OK</b>.</li> </ol>  </li> <li>Mac:                Click <b>System Settings &gt; Printers &amp; Scanners</b> or <b>System Preferences &gt; Printers &amp; Scanners</b>.</li> </ul>
Your machine is not connected to the wireless network.	Print the WLAN Report to check the error code on the printed report. See <i>Related Information: Print the WLAN Report</i> .

If you have checked and tried all of the above, but your machine still cannot print, uninstall the driver (Windows) and reinstall it.



---

## Related Information

---

- [If You Are Having Difficulty with Your Machine's Network](#)

### **Related Topics:**

- [Print the WLAN Report](#)
  - [Wireless LAN Report Error Codes](#)
  - [Use the Network Connection Repair Tool \(Windows\)](#)
  - [I Want to Check that My Network Devices are Working Correctly](#)
-

## I Want to Check that My Network Devices are Working Correctly

**Related Models:** HL-L2405W/HL-L2420DW/HL-L2460DW/HL-L2460DWXL/HL-L2865DW

Check	Action
Check that your Brother machine, access point/router, or network hub is turned on.	<p><b>Check the following:</b></p> <ul style="list-style-type: none"> <li>• The power cord is connected correctly and the Brother machine is turned on.</li> <li>• The access point/router or hub is turned on and its link LED is blinking.</li> <li>• All protective packaging has been removed from the machine.</li> <li>• The toner cartridge and drum unit assembly is installed correctly.</li> <li>• The machine's cover is fully closed.</li> <li>• Paper is loaded correctly in the paper tray.</li> <li>• (For wired networks) A network cable is securely connected to the Brother machine and to the router or hub.</li> </ul>
Check the <b>Link Status</b> on the Network Configuration Report or the Printer Settings page.	Print the Network Configuration Report and check that <b>Ethernet Link Status</b> or <b>Wireless Link Status</b> is <b>Link OK</b> .
Check that you can "ping" the Brother machine from your computer.	<p>Ping the Brother machine from your computer using the IP address or the node name in the Windows command prompt or Mac Terminal application:</p> <p>ping &lt;ipaddress&gt; or &lt;nodename&gt;.</p> <ul style="list-style-type: none"> <li>• Successful: Your Brother machine is working correctly and connected to the same network as your computer.</li> <li>• Unsuccessful: Your Brother machine is not connected to the same network as your computer.</li> </ul> <p>Windows: Ask your administrator about the IP address and the subnet mask, and then use the Network Connection Repair Tool.</p> <p>Mac: Confirm that the IP address and the Subnet Mask are set correctly.</p>
Check that your Brother machine is connected to the wireless network.	<p>Print the WLAN Report to check the error code on the printed report.</p> <p>See <i>Related Information: Print the WLAN Report</i>.</p>

If you have checked and tried all of the above but you are still having problems, see the instructions supplied with your wireless access point/router to find the SSID (Network Name) and the Network Key (Password) information and set them correctly.

### ✓ Related Information

- [If You Are Having Difficulty with Your Machine's Network](#)

#### Related Topics:

- [Print the Network Configuration Report](#)
- [Print the WLAN Report](#)
- [Wireless LAN Report Error Codes](#)
- [Use the Network Connection Repair Tool \(Windows\)](#)
- [My Machine Cannot Print over the Network](#)

## AirPrint Problems

**Related Models:** HL-L2405W/HL-L2420DW/HL-L2460DW/HL-L2460DWXL/HL-L2865DW

Difficulties	Suggestions
My machine is not displayed in the printer list.	Make sure your machine is turned on.
	Make sure your machine and your mobile device or Mac are connected to the same network.
	Move your mobile device closer to the wireless access point/router, or to your machine.
I cannot print.	Make sure your machine is turned on.
	Make sure your machine and your mobile device or Mac are connected to the same network.
I am trying to print a multi-page document from an iOS device, but ONLY the first page is printing.	Make sure you are running the latest OS version.





### Related Information

- [Troubleshooting](#)

#### Related Topics:

- [AirPrint Overview](#)

## Other Problems

Difficulties	Suggestions
The machine will not turn on.	<p>Adverse conditions on the power connection (such as lightning or a power surge) may have triggered the machine's internal safety mechanisms. Unplug the power cord. Wait for ten minutes, then plug in the power cord and press  to turn on the machine.</p> <p>If the problem is not solved, press and hold  to turn off the machine. If you are using a backup battery or surge suppressor device, disconnect it to make sure it is not the problem. Plug the machine's power cord directly into a different known working wall outlet and press  to turn on the machine.</p>
The Brother software cannot be installed.	<p><b>(Windows)</b></p> <p>If the Security Software warning appears on the computer screen during the installation, change the Security Software settings to permit the Brother product setup program or other program to run.</p> <p><b>(Mac)</b></p> <p>If you are using a firewall function of anti-spyware or antivirus security software, temporarily disable it and then install the Brother software.</p>



### Related Information

- [Troubleshooting](#)

## Check the Machine Information

**Related Models:** HL-L2405W/HL-L2420DW/HL-L2460DW/HL-L2460DWXL/HL-L2865DW

Follow these instructions to check your machine's serial number and firmware version.

1. Press **▲** or **▼** to select the [Machine Info.] option, and then press **OK**.
2. Press **▲** or **▼** to select one of the following options:

Option	Description
Serial No.	Check your machine's serial number.
Firmware Version	Check your machine's firmware version.
Page Counter	Check the total number of pages the machine has printed.
Parts Life	Check the supplies' life that remains available.

3. Press **OK**.

### Related Information

- [Troubleshooting](#)

## Update Your Machine's Firmware

**Related Models:** HL-L2405W/HL-L2420DW/HL-L2460DW/HL-L2460DWXL/HL-L2865DW

To keep your machine performance up to date, check [support.brother.com/downloads](http://support.brother.com/downloads) for the latest firmware upgrade. Otherwise, some of your machine's functions may not be available.



### Related Information

- [Troubleshooting](#)

#### Related Topics:

- [Check Your Machine's Password](#)
-

## Reset Functions

- [Machine Reset](#)
- [Network Reset](#)
- [Factory Reset](#)



## Machine Reset

Use the Machine Reset function to reset the machine's settings to the factory settings.



The network settings and the security settings will not be reset by the Machine Reset function.

>> [HL-L2400D](#)

>> [HL-L2405W/HL-L2420DW/HL-L2460DW/HL-L2460DWXL/HL-L2865DW](#)

### HL-L2400D

We strongly recommend you perform this operation when you dispose of the machine.

1. Press and hold  to turn the machine off.
2. Make sure that the front cover is closed and the power cord is plugged in.
3. Hold down **Go** as you press  to turn on the machine. Keep **Go** pressed down until the **Toner**, **Drum**, and **Paper** LEDs light up.
4. Release **Go**. Make sure that all LEDs turn off.
5. Press **Go** ten (10) times.  
The machine restarts automatically.

### HL-L2405W/HL-L2420DW/HL-L2460DW/HL-L2460DWXL/HL-L2865DW

1. Press **▲** or **▼** to select the following:
  - a. Select [Initial Setup]. Press **OK**.
  - b. Select [Reset]. Press **OK**.
  - c. Select [Machine Reset]. Press **OK**.
2. Press **▼** to select [Reset].
3. Press **▼** to restart the machine.



### Related Information

- [Reset Functions](#)

#### Related Topics:

- [Check Your Machine's Password](#)

## Network Reset

**Related Models:** HL-L2405W/HL-L2420DW/HL-L2460DW/HL-L2460DWXL/HL-L2865DW

Use the Network Reset function to restore the machine's network settings back to its default factory settings (includes IP Address information, except the administrator password).

Unplug all the interface cables before you perform a Network Reset.

1. Press ▲ or ▼ to select the following:
  - a. Select [Initial Setup]. Press **OK**.
  - b. Select [Reset]. Press **OK**.
  - c. Select [Network Reset]. Press **OK**.
2. Press ▼ to select [Reset].
3. Press ▼ to restart the machine.



### Related Information

- [Reset Functions](#)

## Factory Reset



Use the Factory Reset function to restore all settings back to the factory settings.

Unplug all the interface cables before you perform a Factory Reset.

>> [HL-L2400D](#)

>> [HL-L2405W/HL-L2420DW/HL-L2460DW/HL-L2460DWXL/HL-L2865DW](#)

### HL-L2400D

1. Press and hold  to turn off the machine.
2. Make sure that the front cover is closed and the power cord is plugged in.
3. Hold down **Go** as you press  to turn on the machine. Keep **Go** pressed down until the **Toner**, **Drum**, and **Paper** LEDs light up.
4. Release **Go**. Make sure that all LEDs turn off.
5. Press **Go** eight (8) times.

Make sure that all four LEDs light up, indicating that the machine has been reset to its factory default settings.

### HL-L2405W/HL-L2420DW/HL-L2460DW/HL-L2460DWXL/HL-L2865DW

1. Press **▲** or **▼** to select the following:
  - a. Select [Initial Setup]. Press **OK**.
  - b. Select [Reset]. Press **OK**.
  - c. Select [Factory Reset]. Press **OK**.
2. Press **▼** to select [Reset].
3. Press **▼** to restart the machine.



### Related Information

- [Reset Functions](#)

## **Routine Maintenance**

- [Replace Supplies](#)
- [Clean the Machine](#)
- [Check the Remaining Part Life](#)
- [Pack and Ship Your Machine](#)

## Replace Supplies

You must replace supplies when the machine indicates that the life of the supply is over.

The toner cartridge and drum unit are two separate supplies. Make sure both are installed as an assembly. The order number of supplies may vary depending on the country.

### NOTE

- Be sure to seal the used supplies tightly in a bag so that toner powder does not spill out of the cartridge.
- Brother is committed to minimizing the environmental impact due to waste. For more information on recycling options, contact your local recycling office or visit:
- We recommend placing both the new and the used supplies on a piece of paper to prevent accidentally spilling or scattering the contents.
- Using paper that is not a direct equivalent for a recommended print media may reduce the life of supplies and machine parts.
- The projected life for each of the toner cartridges is based on ISO/IEC 19752. Frequency of replacement will vary depending on the print volume, percentage of coverage, types of media used, and powering on/off the machine.
- Frequency of replacing supplies except toner cartridges will vary depending on the print volume, types of media used, and powering on/off the machine.
- Handle the toner cartridge carefully. If toner scatters on your hands or clothes, immediately wipe or wash it off with cold water.

### IMPORTANT

To avoid print quality problems, DO NOT touch the shaded parts shown in the illustrations.

#### Toner Cartridge

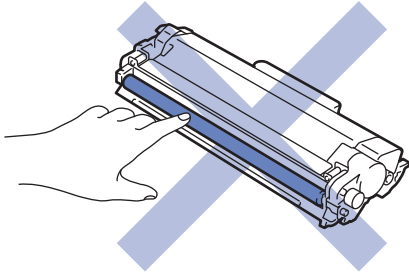

#### Drum Unit

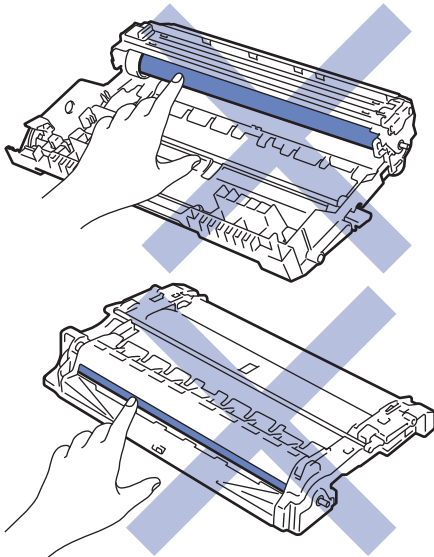



## Related Information

- Routine Maintenance
  - Replace the Toner Cartridge
  - Replace the Drum Unit
  - Reset the Drum Counter

### Related Topics:

- Error and Maintenance LED Indications
  - Error and Maintenance Messages
-

## Replace the Toner Cartridge

1. Make sure the machine is turned on.
2. Open the front cover.

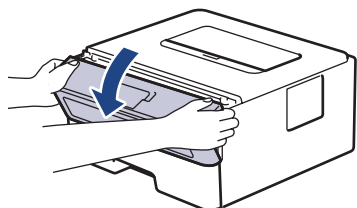

3. Remove the toner cartridge and drum unit assembly from the machine.

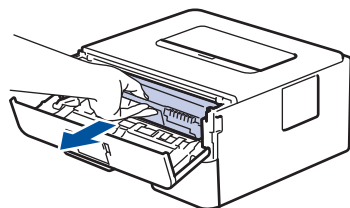

4. Push down the green lock lever and take the toner cartridge out of the drum unit.

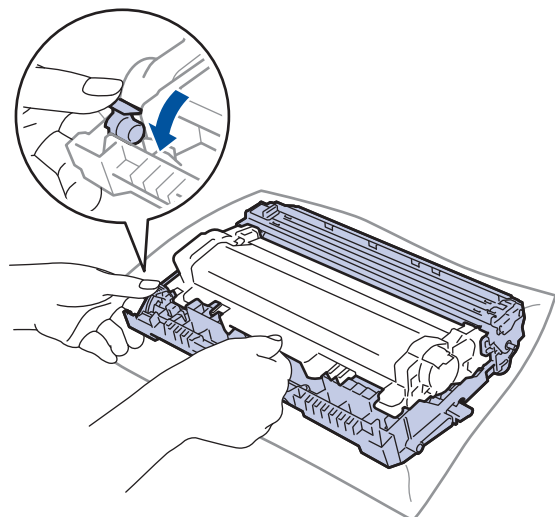

5. Unpack the new toner cartridge.
6. Remove the protective cover.

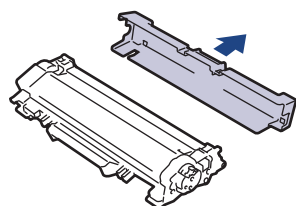

- 
7. Hold the toner cartridge by the handle and shake it from left to right several times, as shown. Then push it firmly into the drum unit until it locks into place.

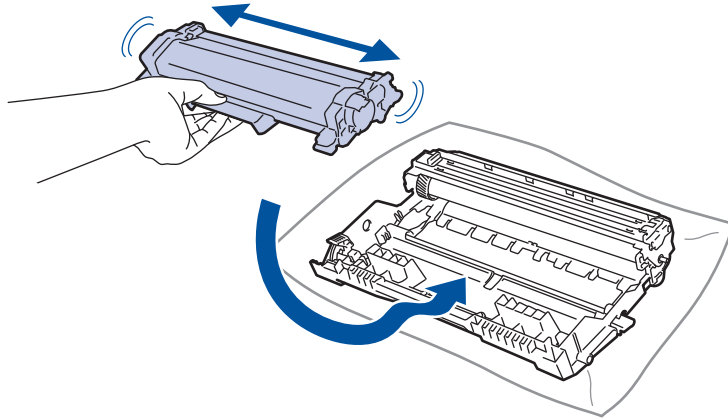

---

Make sure you put the toner cartridge in correctly or it may separate from the drum unit.

---

8. Clean the corona wire inside the drum unit by gently sliding the green tab from left to right and right to left several times.

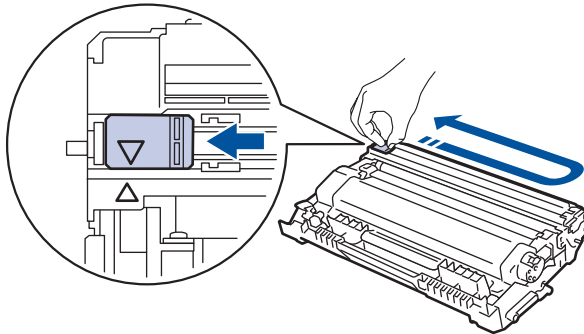

---

Be sure to return the tab to the Home position (▲). The arrow on the tab must be aligned with the arrow on the drum unit. If it is not, printed pages may have a vertical stripe.

---

9. Reinsert the toner cartridge and drum unit assembly back into the machine.

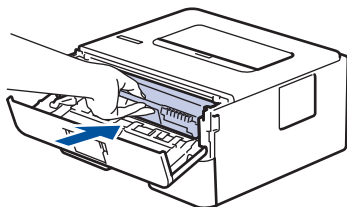

10. Close the front cover of the machine.



- 
- Do not turn off the machine or open the front cover until the machine returns to Ready Mode.
  - The toner cartridge that comes with your Brother machine is a Starter toner cartridge.
  - It is a good idea to keep a new toner cartridge ready for use when you see the Toner Low warning.
  - DO NOT unpack the new toner cartridge until you are ready to install it.
  - If a toner cartridge is left unpacked for a long time, the toner life will be shortened.
  - We recommend using genuine Brother supplies to ensure stable print quality and performance. Although not all non-genuine supplies may cause quality issues, it is possible that some may adversely affect print quality or cause machine malfunction. Brother may charge for repairing your machine if it is proven that non-genuine supplies caused the damage, even if the machine is still covered by the warranty.
- 



## Related Information

- [Replace Supplies](#)



---

**Related Topics:**

- [Error and Maintenance LED Indications](#)
  - [Error and Maintenance Messages](#)
  - [Improve the Print Quality](#)
-

## Replace the Drum Unit

1. Make sure the machine is turned on.
2. Open the front cover.

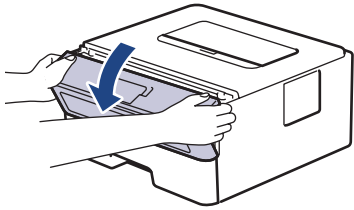

3. Remove the toner cartridge and drum unit assembly from the machine.

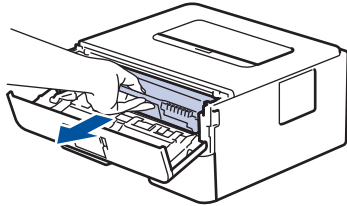

4. Push down the green lock lever and take the toner cartridge out of the drum unit.

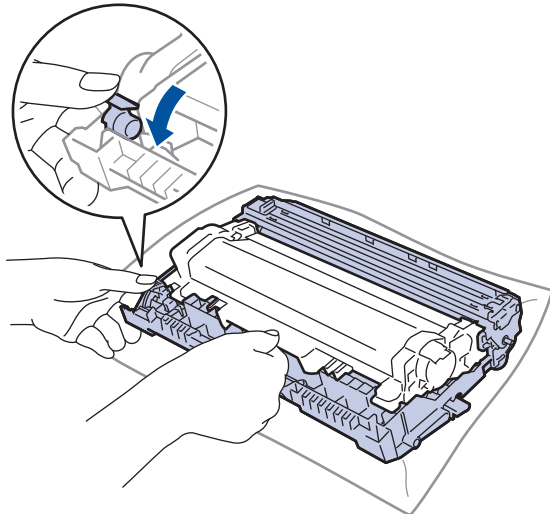

5. Unpack the new drum unit.
6. Push the toner cartridge firmly into the new drum unit until it locks into place.

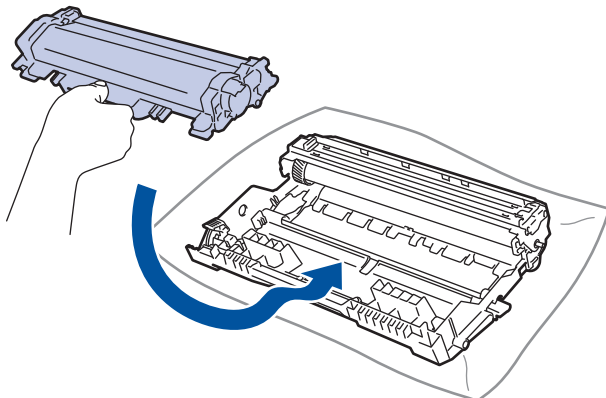

Make sure you put the toner cartridge in correctly or it may separate from the drum unit.

- 
7. Reinsert the toner cartridge and drum unit assembly back into the machine.

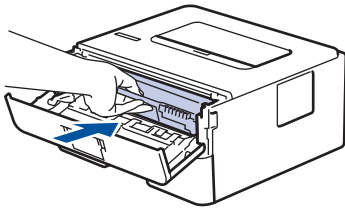

8. Close the front cover of the machine.



---

After installing the new drum unit, you must reset the drum counter. See *Related Information: Reset the Drum Counter*.

---

## NOTE

- Drum wear and tear occurs due to use and rotation of the drum and interaction with paper, toner, and other materials in the paper path. In designing this product, Brother decided to use the number of rotations of the drum as a reasonable determinant of the drum life. When a drum reaches the factory-established rotation limit corresponding to the rated page yield, the product's LCD will advise you to replace the drum. The product will continue to function; however, print quality may not be optimal.
- If an unpacked drum unit is placed in direct sunlight (or room light for long periods of time), the unit may be damaged.
- There are many factors that determine the actual drum life, such as the temperature, humidity, type of paper, type of toner used and so on. Under ideal conditions, the average drum life is estimated at approximately 15,000 pages based on one page per job (A4/Letter single-sided pages). The number of pages may be affected by a variety of factors including, but not limited to, media type and media size.

Because we have no control over the many factors that determine the actual drum life, we cannot guarantee a minimum number of pages that will be printed by your drum.

- The machine should be used only in a clean, dust-free environment with adequate ventilation.

We recommend using genuine Brother supplies to ensure stable print quality and performance. Although not all non-genuine supplies may cause quality issues, it is possible that some may adversely affect print quality or cause machine malfunction. Brother may charge for repairing your machine if it is proven that non-genuine supplies caused the damage, even if the machine is still covered by the warranty.



## Related Information

- [Replace Supplies](#)

### Related Topics:

- [Error and Maintenance LED Indications](#)
  - [Error and Maintenance Messages](#)
  - [Improve the Print Quality](#)
  - [Reset the Drum Counter](#)
-

## Reset the Drum Counter

When you replace the drum unit with a new one, you must reset the drum counter by completing the following steps:

### IMPORTANT

DO NOT reset the drum counter unless you are replacing the drum unit.

>> [HL-L2400D](#)

>> [HL-L2405W/HL-L2420DW/HL-L2460DW/HL-L2460DWXL/HL-L2865DW](#)

### HL-L2400D

1. Make sure the machine is turned on.
2. Open the front cover.

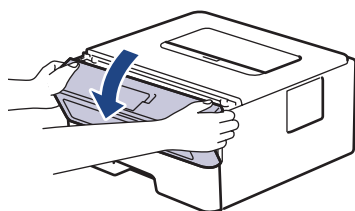

3. Press and hold **Go** for about four seconds until all LEDs light up. When all four LEDs are lit, release **Go**.
4. Close the front cover of the machine.
5. Make sure the **Drum** LED is now off.

### HL-L2405W/HL-L2420DW/HL-L2460DW/HL-L2460DWXL/HL-L2865DW

1. Make sure the machine is turned on.
2. Make sure the machine's cover is closed.
3. Press **OK** and **▲** at the same time.
4. Press **OK** to select [Drum].
5. Select [Reset] to reset the drum counter.



### Related Information

- [Replace Supplies](#)

#### Related Topics:

- [Error and Maintenance LED Indications](#)
- [Error and Maintenance Messages](#)
- [Replace the Drum Unit](#)

## Clean the Machine

Clean the outside and inside of the machine regularly with a dry, lint-free cloth.

When you replace the toner cartridge or the drum unit, make sure you clean the inside of the machine. If printed pages are stained with toner, clean the inside of the machine with a dry, lint-free cloth.

### **!** WARNING

DO NOT use flammable substances, any type of spray, or an organic solvent/liquid containing alcohol or ammonia to clean the inside or outside of the product. Doing so could cause a fire. Instead, use only a dry, lint-free cloth.



### IMPORTANT

- DO NOT use isopropyl alcohol to remove dirt from the control panel. It may crack the panel.
- To avoid print quality problems, DO NOT touch the shaded parts shown in the illustrations.

#### Toner cartridge

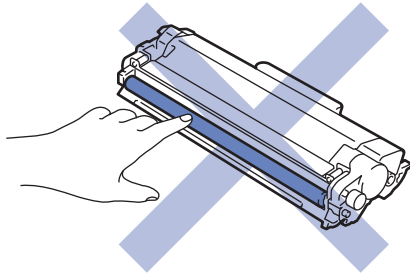

#### Drum unit

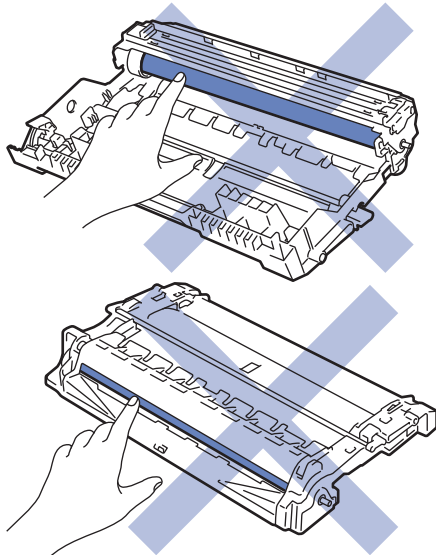



(For certain models) The toner cartridge features an IC chip. DO NOT touch this surface. Touching the IC chip may cause contamination or damage, and may interfere with the machine's ability to detect this component.

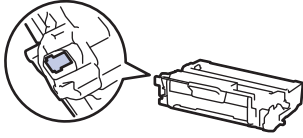

### Related Information

- Routine Maintenance
    - Clean the Corona Wire
    - Clean the Drum Unit
    - Clean the Paper Pick-up Rollers
-

## Clean the Corona Wire

If you have print quality problems or the control panel displays [Drum !] status, clean the corona wire.

1. Open the front cover.

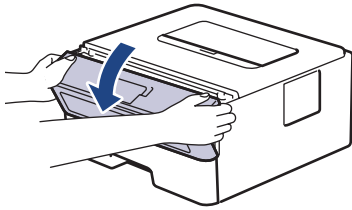

2. Remove the toner cartridge and drum unit assembly from the machine.

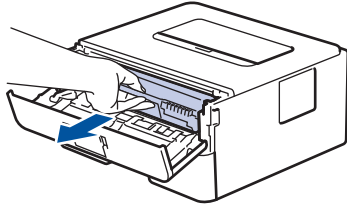

3. Clean the corona wire inside the drum unit by gently sliding the green tab from left to right and right to left several times.

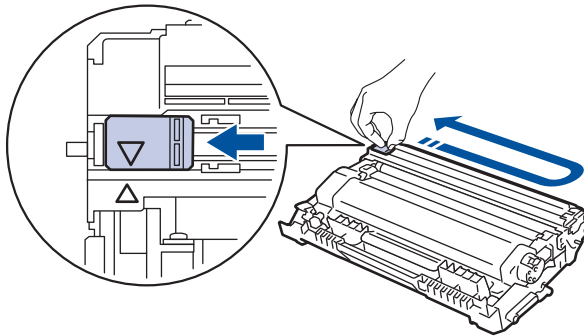

Be sure to return the tab to the Home position (▲). The arrow on the tab must be aligned with the arrow on the drum unit. If it is not, printed pages may have a vertical stripe.

4. Reinsert the toner cartridge and drum unit assembly back into the machine.

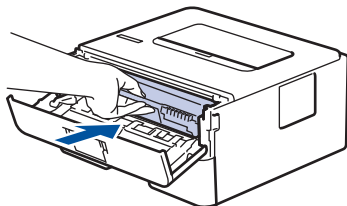

5. Close the front cover of the machine.



### Related Information

- [Clean the Machine](#)

#### Related Topics:

- [Error and Maintenance LED Indications](#)
- [Error and Maintenance Messages](#)

## Clean the Drum Unit

If your printout has dots or other repeating marks at 3.7 in. (94 mm) intervals, the drum may have foreign material, such as glue from a label, stuck on the drum surface.

>> [HL-L2400D](#)

>> [HL-L2405W/HL-L2420DW/HL-L2460DW/HL-L2460DWXL/HL-L2865DW](#)

### HL-L2400D

1. Make sure the machine is in Ready mode.
2. Press **Go** eight (8) times.  
The machine prints the Drum Dot Check Sheet.
3. Press and hold  to turn off the machine.
4. Open the front cover.

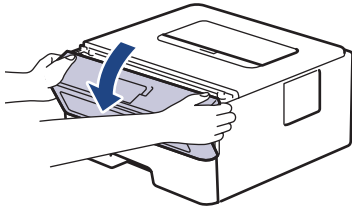

5. Remove the toner cartridge and drum unit assembly from the machine.

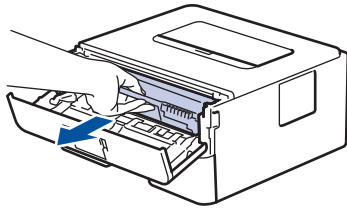

6. Push down the green lock lever and take the toner cartridge out of the drum unit.

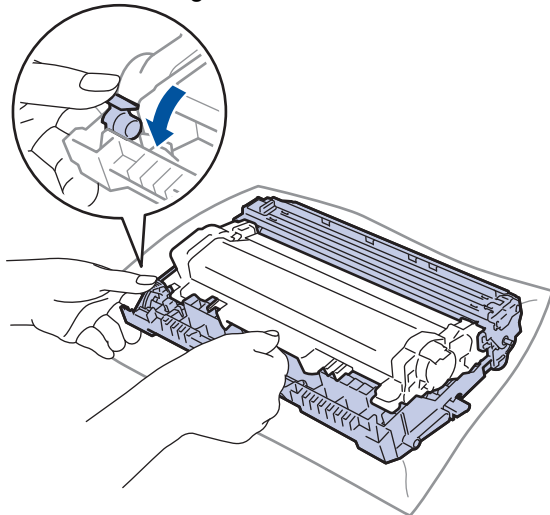

7. Turn the drum unit as shown in the illustration. Make sure that the drum unit gear (1) is on the left side.

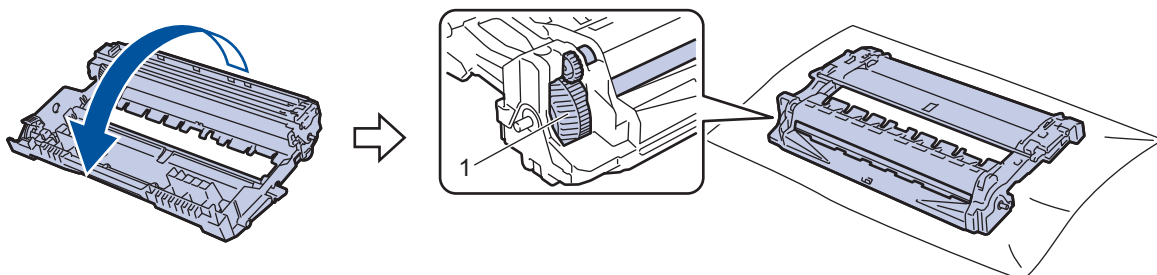



8. Use the numbered markers next to the drum roller to find the mark on the drum. For example, a dot in column 2 on the check sheet means that there is a mark in drum region “2”.

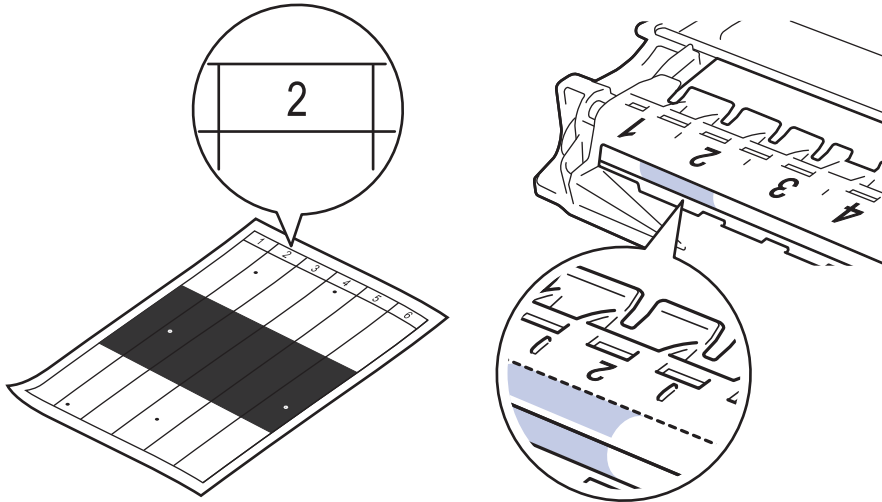

9. Turn the drum unit edge toward you while looking at the drum surface to find the mark.

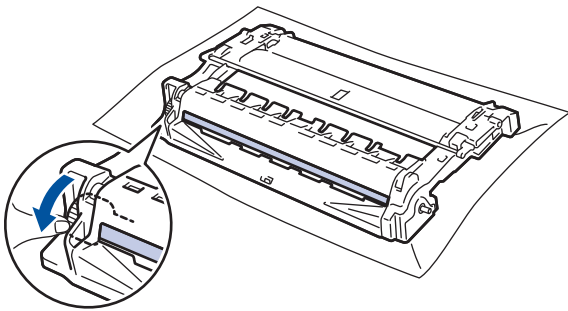

## IMPORTANT

To avoid print quality problems, DO NOT touch the surface of the drum unit, only the wheel on the end.

10. Wipe the drum unit surface gently with a dry cotton swab until the mark or foreign material on the surface comes off.

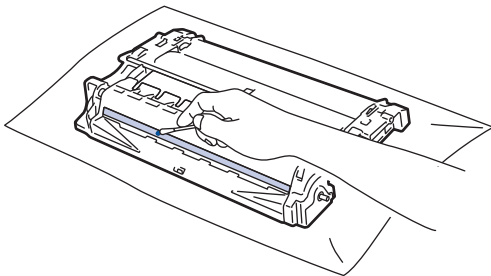

## NOTE

DO NOT clean the surface of the photosensitive drum with a sharp object or any liquids.

11. Turn the drum unit as shown in the illustration. Make sure that the drum unit gear (1) is on the left side.

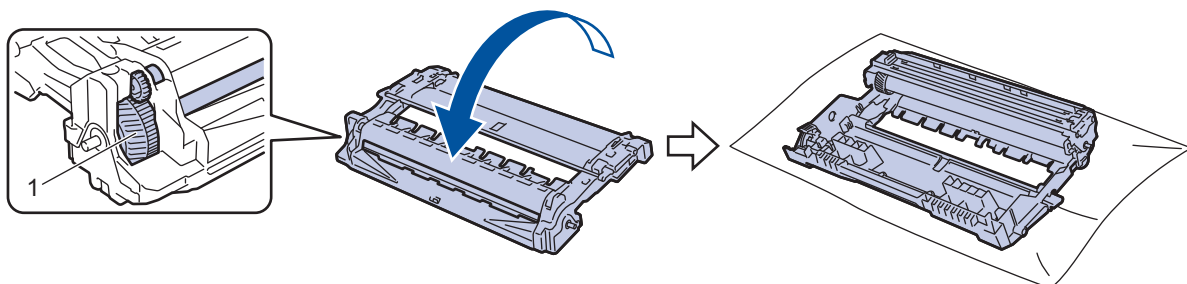

12. Push the toner cartridge firmly into the drum unit until it locks into place.

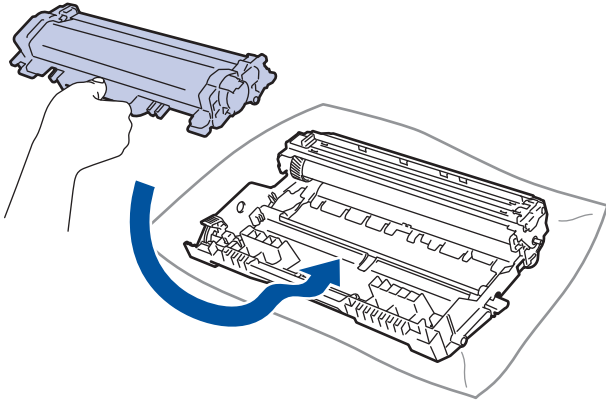

Make sure you put the toner cartridge in correctly or it may separate from the drum unit.

13. Reinsert the toner cartridge and drum unit assembly back into the machine.

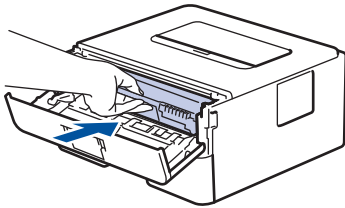

14. Close the front cover of the machine.

15. Press  to turn on the machine.

## HL-L2405W/HL-L2420DW/HL-L2460DW/HL-L2460DWXL/HL-L2865DW

1. Make sure the machine is in Ready mode.
2. Press **▲** or **▼** to display the [Print Reports] option, and then press **OK**.
3. Press **▲** or **▼** to select the [Drum Dot Print] option, and then press **OK**.
4. Press **Go**.  
The machine prints the Drum Dot Check Sheet.
5. Press **Back** twice.
6. Press and hold  to turn off the machine.
7. Open the front cover.

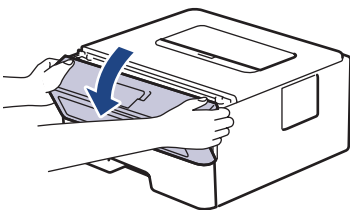

8. Remove the toner cartridge and drum unit assembly from the machine.

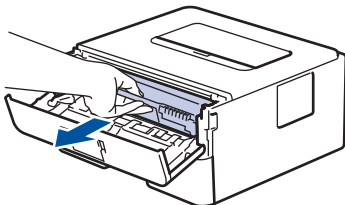

9. Push down the green lock lever and take the toner cartridge out of the drum unit.

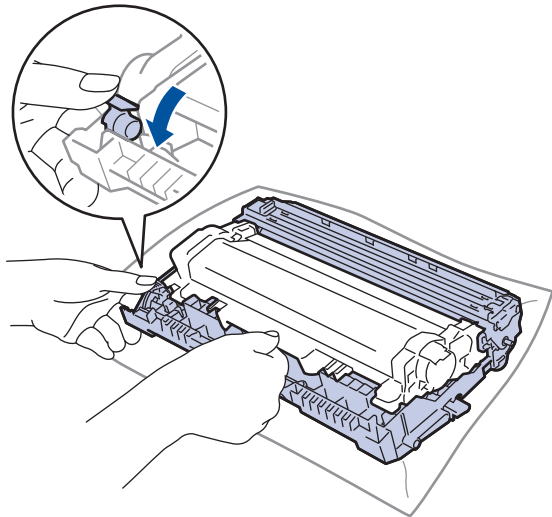

10. Turn the drum unit as shown in the illustration. Make sure that the drum unit gear (1) is on the left side.

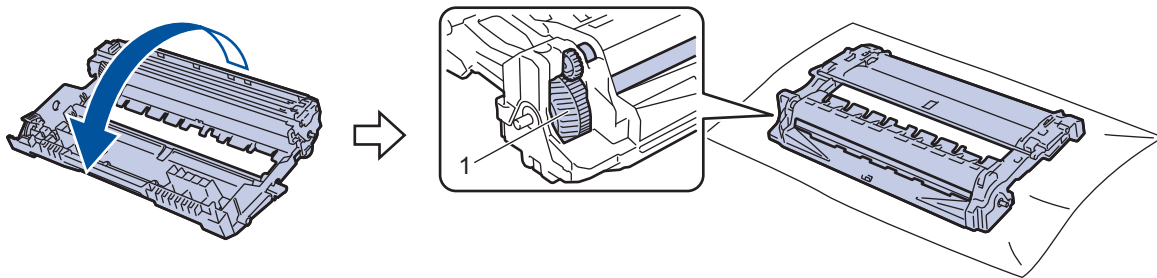

11. Use the numbered markers next to the drum roller to find the mark on the drum. For example, a dot in column 2 on the check sheet means that there is a mark in drum region "2".

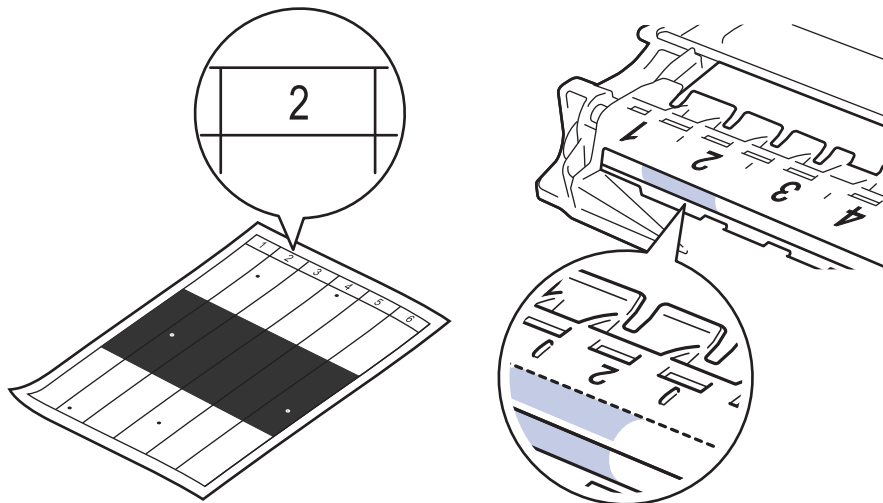

12. Turn the drum unit edge toward you while looking at the drum surface to find the mark.

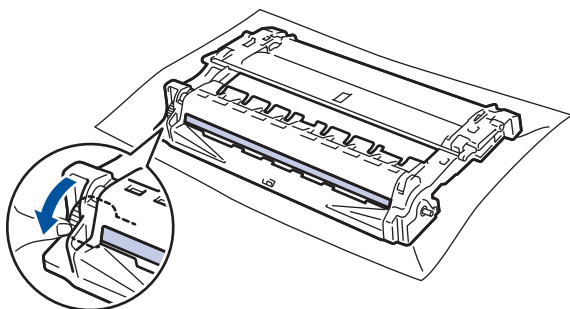

## IMPORTANT

To avoid print quality problems, DO NOT touch the surface of the drum unit, only the wheel on the end.

13. Wipe the drum unit surface gently with a dry cotton swab until the mark or foreign material on the surface comes off.

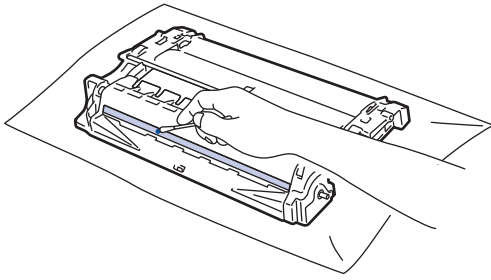

## NOTE

DO NOT clean the surface of the photosensitive drum with a sharp object or any liquids.

14. Turn the drum unit as shown in the illustration. Make sure that the drum unit gear (1) is on the left side.

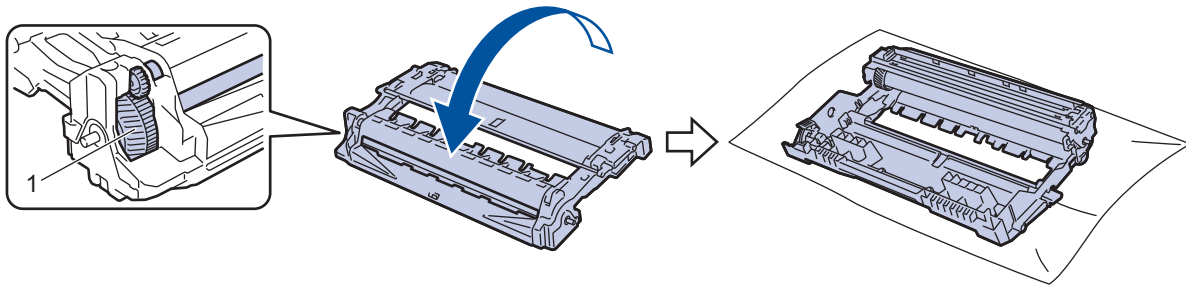

15. Push the toner cartridge firmly into the drum unit until it locks into place.

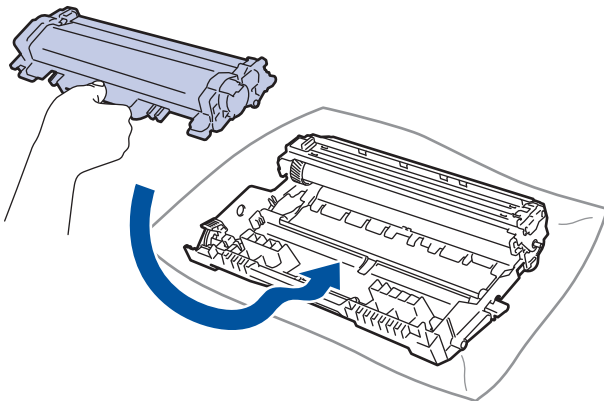

Make sure you put the toner cartridge in correctly or it may separate from the drum unit.

16. Reinsert the toner cartridge and drum unit assembly back into the machine.

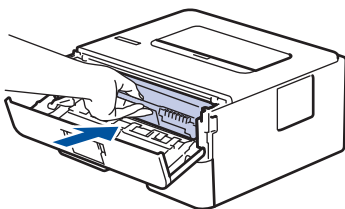

17. Close the front cover of the machine.

18. Press  to turn on the machine.

## ✓ Related Information

- [Clean the Machine](#)

### Related Topics:

- [Improve the Print Quality](#)

## Clean the Paper Pick-up Rollers

Cleaning the paper pick-up rollers periodically may prevent paper jams by ensuring that paper feeds correctly.

Before starting the cleaning procedure, see *Related Information: Clean the Machine*.

If you have paper feed problems, clean the pick-up rollers as follows:

1. Press and hold  to turn off the machine.
2. Pull the paper tray completely out of the machine.

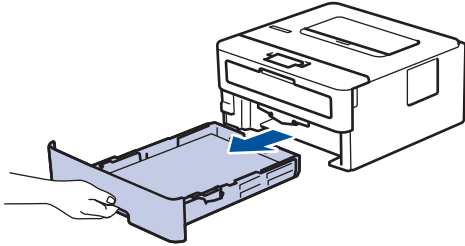

3. If paper is loaded or something is stuck inside in the paper tray, remove it.
4. Tightly wring out a lint-free cloth soaked in lukewarm water, and then wipe the separator pad on the paper tray to remove dust.

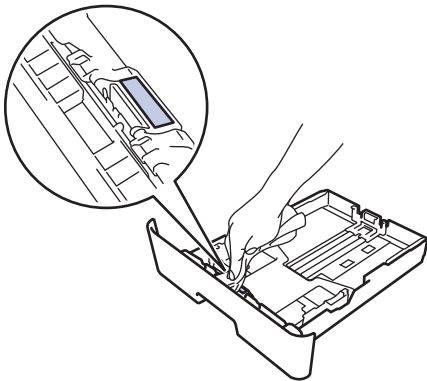

5. Wipe the two pick-up rollers inside the machine to remove dust.

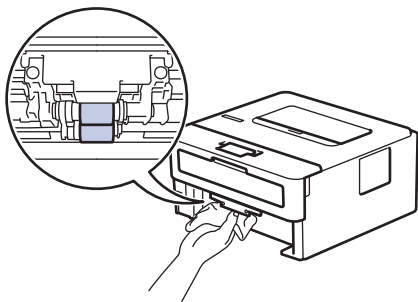

6. Reload the paper and put the paper tray firmly back in the machine.
7. Press  to turn on the machine.

### Related Information

- [Clean the Machine](#)

#### Related Topics:

- [Printing Problems](#)

## Check the Remaining Part Life

**Related Models:** HL-L2405W/HL-L2420DW/HL-L2460DW/HL-L2460DWXL/HL-L2865DW

1. Press ▲ or ▼ to select the following:
  - a. Select [Machine Info.]. Press **OK**.
  - b. Select [Parts Life]. Press **OK**.
2. Press ▲ or ▼ to select the machine part you want to check, and then press **OK**.  
The LCD displays the approximate remaining part life.



### Related Information

- [Routine Maintenance](#)

## Pack and Ship Your Machine



- If for any reason you must ship your machine, carefully repack the machine in the original packaging to avoid any damage during transit. The machine should be adequately insured with the carrier.
- Unless you are returning the machine as part of the Brother Exchange Service, leave the toner cartridge and drum unit inside the machine when you pack and ship it.

1. Press and hold  to turn off the machine. Leave the machine off for at least 10 minutes to cool down.
2. Disconnect all the cables, and then unplug the power cord from the AC power outlet.



Some models are equipped with a non-detachable AC power cord. If your cord is not detachable, fold it loosely and rest it on top of the machine so it packs easily.

3. Put the machine into the bag it originally came in.
4. Pack the machine, the printed materials, and the AC power cord (if applicable) in the original carton with the original packing material as shown. (The original packing material may differ depending on your country.) If you are returning your machine to Brother as part of the Exchange Service, pack only the machine. The illustrations may differ from the actual packing materials. The materials vary depending on your model.

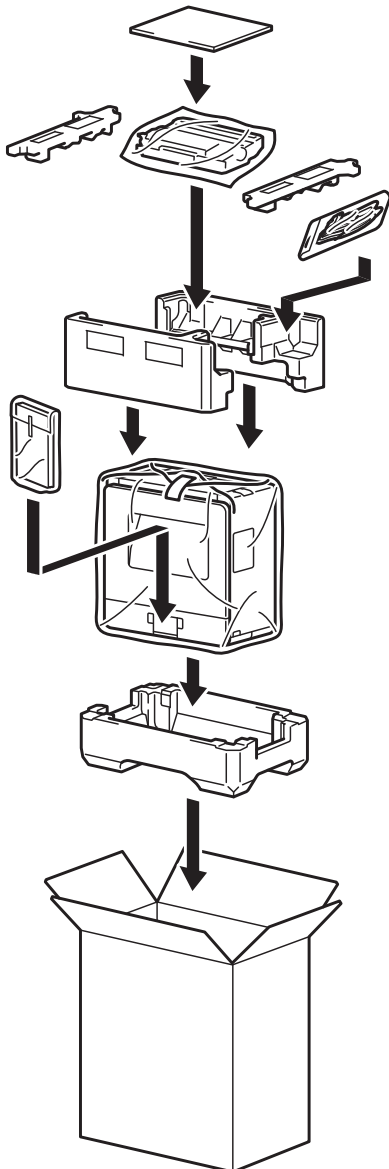

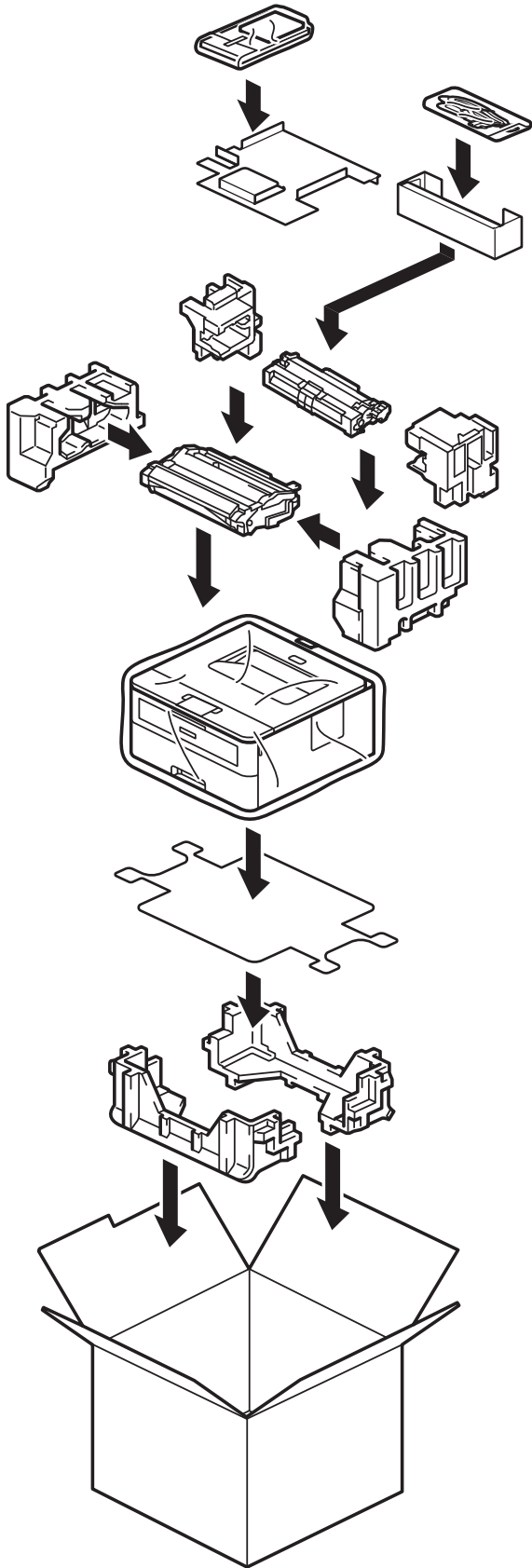

5. Close the carton and tape it shut.



### Related Information

- [Routine Maintenance](#)



## Machine Settings

Customize settings and features to make your machine a more efficient work tool.

- [Check Your Machine's Password](#)
- [Change Machine Settings from the Control Panel](#)
- [Print a List of Printer Settings](#)
- [Change Machine Settings from Windows Printer Driver](#)
- [Change Machine Settings Using Web Based Management](#)

## Check Your Machine's Password

**Related Models:** HL-L2405W/HL-L2420DW/HL-L2460DW/HL-L2460DWXL/HL-L2865DW

If prompted to enter a password, check the following information:

- >> [Find the Default Password](#)
- >> [Change the Password](#)
- >> [Reset the Password](#)

### Find the Default Password

The default password to manage this machine's settings is located on the back of the machine and marked "Pwd".

### Change the Password

We recommend immediately changing the default password to protect your machine from unauthorized access.

Use Web Based Management to change the password.  
For more information, see *Related Information*.

### Reset the Password

If you forget your password, reset your machine to its factory default settings. The password will also be reset to the default password.

For more information, see *Related Information*.

### ✓ Related Information

- [Machine Settings](#)

#### Related Topics:

- [Machine Reset](#)
- [Update Your Machine's Firmware](#)

## Change Machine Settings from the Control Panel

- [General Settings](#)
- [Menu Table \(for LCD Models\)](#)

## General Settings

- [Set Sleep Mode Countdown](#)
- [About Deep Sleep Mode](#)
- [Set Auto Power Off Mode](#)
- [Reduce Toner Consumption](#)
- [Set the Continue Mode](#)
- [Reduce Printing Noise](#)
- [Change the Language on the LCD](#)

## Set Sleep Mode Countdown

**Related Models:** HL-L2405W/HL-L2420DW/HL-L2460DW/HL-L2460DWXL/HL-L2865DW

The Sleep Mode (or Power Save Mode) setting can reduce power consumption. Select how long the machine must be idle before it goes into Sleep Mode. The Sleep Mode timer is reset when the machine receives a print job.

When the machine is in Sleep Mode, it acts as if it is turned off. The machine will wake up and start printing when it receives a print job. Use these instructions to set a time delay (countdown) before the machine enters Sleep Mode.



The Sleep Mode setting cannot be disabled due to environmental considerations.

1. Press ▲ or ▼ to select the following:
  - a. Select [General Setup]. Press **OK**.
  - b. Select [Ecology]. Press **OK**.
  - c. Select [Sleep Time]. Press **OK**.
2. Press ▲ or ▼ to enter the length of time (up to 50 minutes) that the machine should remain idle before entering Sleep Mode.  
Press **Go**.



### Related Information

- [General Settings](#)

## About Deep Sleep Mode

If the machine is in Sleep Mode and does not receive any jobs for a certain length of time, the machine will automatically enter Deep Sleep Mode. The length of time is based on your specific model and settings.

Deep Sleep Mode uses less power than Sleep Mode.



The Deep Sleep Mode setting cannot be disabled due to environmental considerations.

Applicable Models	Machine's Control Panel in Deep Sleep Mode	Conditions That Will Wake the Machine
HL-L2400D	 The <b>Ready</b> LED is dimmed.	<ul style="list-style-type: none"><li>• The machine receives a job.</li><li>• Someone presses a button on the control panel.</li></ul>
HL-L2405W/HL-L2420DW/ HL-L2460DW/HL-L2460DWXL/ HL-L2865DW	The LCD displays <i>Deep Sleep</i> .	<ul style="list-style-type: none"><li>• The machine receives a job.</li><li>• Someone presses a button on the control panel.</li></ul>



### Related Information

- [General Settings](#)

## Set Auto Power Off Mode

If the machine is in Deep Sleep Mode for certain length of time, based on your model and settings, the machine will go into Power Off Mode automatically. The machine does not go into Power Off Mode when the machine is connected to a network.

To start printing, press  on the control panel and then send a print job.

>> [HL-L2400D](#)

>> [HL-L2405W/HL-L2420DW/HL-L2460DW/HL-L2460DWXL/HL-L2865DW](#)

### HL-L2400D

1. Make sure that the front cover is closed and the power cord is plugged in.
2. Press  to turn on the machine and make sure only the **Ready** LED lights up.
3. Press **Go** four (4) times to turn the function On or Off.  
All LEDs blink twice when Auto Power Off Mode is turned on.  
All LEDs blink once when Auto Power Off Mode is turned off.

### HL-L2405W/HL-L2420DW/HL-L2460DW/HL-L2460DWXL/HL-L2865DW



Select how long the machine must be in Deep Sleep Mode before it goes into Auto Power Off Mode.

1. Press **▲** or **▼** to select the following:
  - a. Select [General Setup]. Press **OK**.
  - b. Select [Ecology]. Press **OK**.
  - c. Select [Auto Power Off]. Press **OK**.
2. Press **▲** or **▼** to select the length of time (1, 2, 4, or 8 hours) that the machine should remain idle before entering Power Off Mode.
3. Press **Go**.



### Related Information

- [General Settings](#)

## Reduce Toner Consumption

**Related Models:** HL-L2405W/HL-L2420DW/HL-L2460DW/HL-L2460DWXL/HL-L2865DW

Using the Toner Save feature may reduce toner consumption. When Toner Save is set to on, the print on your documents appears lighter.

We DO NOT recommend using the Toner Save feature for printing photo or grayscale images.

1. Press ▲ or ▼ to select the following:
  - a. Select [General Setup]. Press **OK**.
  - b. Select [Ecology]. Press **OK**.
  - c. Select [Toner Save]. Press **OK**.
2. Press ▲ or ▼ to display [On], and then press **Go**.



### Related Information

- [General Settings](#)

#### Related Topics:

- [Improve the Print Quality](#)



## Set the Continue Mode

The Continue Mode forces the machine to continue printing after the control panel or the Status Monitor displays "Replace Toner".

The machine will continue printing until the LCD or the Status Monitor displays "Toner Ended".

The factory setting is "Stop".



- When the control panel or the Status Monitor indicates an error, you cannot change the mode.
- If you continue printing in the Continue Mode, we cannot guarantee the print quality.
- While using Continue Mode the print may appear faint.
- After replacing the toner cartridge with a new one, the Continue Mode will go back to the factory setting ("Stop").

>> [HL-L2400D](#)

>> [HL-L2405W/HL-L2420DW/HL-L2460DW/HL-L2460DWXL/HL-L2865DW](#)

### HL-L2400D

1. Make sure that the front cover is closed and the power cord is plugged in.
2. Press  to turn on the machine and make sure only the **Ready** LED lights up.
3. Press **Go** seven (7) times to turn the function On or Off.  
All LEDs blink twice when you turn on the Continue Mode.  
All LEDs blink once when you turn off the Continue Mode.

### HL-L2405W/HL-L2420DW/HL-L2460DW/HL-L2460DWXL/HL-L2865DW

1. Press **▲** or **▼** to select the following:
  - a. Select [General Setup]. Press **OK**.
  - b. Select [Replace Toner]. Press **OK**.
2. Press **▲** or **▼** to display [Continue] or [Stop], and then press **Go**.



### Related Information

- [General Settings](#)

## Reduce Printing Noise

The Quiet Mode setting can reduce printing noise. When Quiet Mode is turned on, the print speed becomes slower. The factory setting is off.

>> [HL-L2400D](#)

>> [HL-L2405W/HL-L2420DW/HL-L2460DW/HL-L2460DWXL/HL-L2865DW](#)

### HL-L2400D

1. Make sure that the front cover is closed and the power cord is plugged in.
2. Press  to turn on the machine and wait until the machine is in the Ready mode.
3. Press **Go** 11 times to turn the function On or Off.  
All LEDs blink twice when you turn on the Quiet Mode.  
All LEDs blink once when you turn off the Quiet Mode.
4. Release **Go**. Make sure that all LEDs turn off.

### HL-L2405W/HL-L2420DW/HL-L2460DW/HL-L2460DWXL/HL-L2865DW

1. Press **▲** or **▼** to select the following:
  - a. Select [General Setup]. Press **OK**.
  - b. Select [Ecology]. Press **OK**.
  - c. Select [Quiet Mode]. Press **OK**.
2. Press **▲** or **▼** to display the [On] or [Off] option, and then press **Go**.



### Related Information

- [General Settings](#)

## Change the Language on the LCD

**Related Models:** HL-L2405W/HL-L2420DW/HL-L2460DW/HL-L2460DWXL/HL-L2865DW

Change the LCD language if needed.

This feature is not available in some countries.

1. Press ▲ or ▼ to select the following:
  - a. Select [Initial Setup]. Press **OK**.
  - b. Select [Local Language]. Press **OK**.
2. Press ▲ or ▼ to display your language, and then press **Go**.



### Related Information

- [General Settings](#)

## Menu Table (for LCD Models)

- [Access Menus and Change Your Machine's Settings](#)
- [Settings Tables \(HL-L2405W/HL-L2420DW/HL-L2460DW/HL-L2460DWXL/HL-L2865DW\)](#)

## Access Menus and Change Your Machine's Settings

**Related Models:** HL-L2405W/HL-L2420DW/HL-L2460DW/HL-L2460DWXL/HL-L2865DW

Use the control panel to access the machine's menus and change various settings.

1. Scroll through each menu level by pressing ▲ or ▼.
2. When the option you want appears on the LCD, press **OK**.  
The LCD displays the next menu level.
3. Press ▲ or ▼ to scroll to your selection.
4. Press **OK** or **Go**.
5. When you have finished setting an option, the LCD displays a confirmation message.

### ✓ Related Information

- [Menu Table \(for LCD Models\)](#)

## Settings Tables (HL-L2405W/HL-L2420DW/HL-L2460DW/HL-L2460DWXL/HL-L2865DW)

**Related Models:** HL-L2405W/HL-L2420DW/HL-L2460DW/HL-L2460DWXL/HL-L2865DW

Use these tables to understand the various menus and options that you will use to set your preferences on the machine.

>> [General Setup]  
 >> [Printer]  
 >> [Network] (HL-L2405W/HL-L2420DW)  
 >> [Network] (HL-L2460DW/HL-L2460DWXL/HL-L2865DW)  
 >> [Print Reports]  
 >> [Machine Info.]  
 >> [Initial Setup]

### [General Setup]

Level 3	Level 4	Level 5	Description
Tray Setting	Paper Type	-	Set the type of paper in the paper tray.
	Paper Size	-	Set the paper size in the paper tray.
	Manual Feed	-	Select the paper tray you want to use.
	Print Position	X Offset	Adjust the print start position (usually at the upper left corner of a page) for the paper you loaded in the paper tray horizontally from -500 (left) to +500 (right) dots when printing at 300 dpi.
		Y Offset	Adjust the print start position (usually at the upper left corner of a page) for the paper you loaded in the paper tray vertically from -500 (up) to +500 (down) dots when printing at 300 dpi.
	Check Paper	-	Select whether or not to display a message indicating you must check the paper type and paper size when you pull a paper tray out of the machine.
Ecology	Eco Mode	-	Turn on the following machine settings: <ul style="list-style-type: none"> <li>• 2-sided Print: Long Edge <sup>1 2</sup></li> <li>• Sleep Time: 0Min</li> <li>• Quiet Mode: On <sup>1</sup></li> <li>• Toner Save: On <sup>1</sup></li> </ul>
	Toner Save	-	Increase the page yield of the toner cartridge.
	Sleep Time	-	Set how much time should pass before the machine enters Power Saving mode.
	Quiet Mode	-	Decrease printing noise.
	Auto Power Off	-	Set the number of hours that the machine will remain in Deep Sleep mode before going into Power Off mode.
Panel Control	Button Repeat	-	Set the time for the LCD message to change when holding ▲ or ▼.
	Message Scroll	-	Set the time in seconds that an LCD message will scroll across the LCD. From Level 1 (0.2 s) to Level 10 (2 s).
	LCD Contrast	-	Adjust the contrast of the LCD.
	Auto Online	-	Set the machine to return to Ready mode after it has been idle for 30 seconds.

Level 3	Level 4	Level 5	Description
Setting Lock	-	-	Lock your machine's settings using the Setting Lock password.
Interface	Select (For network models)	-	Select the interface to use. If you select <i>Auto</i> , the machine changes the interface to USB or network depending on which interface is receiving data.
	Auto IF Time	-	Set the time-out period for the auto interface selection.
	Input Buffer	-	Increase or decrease the input buffer capacity.
Replace Toner	-	-	Sets the machine to continue printing after the LCD displays <i>Replace Toner</i> .

<sup>1</sup> Changing this setting is possible only after you change certain machine settings in Web Based Management.

<sup>2</sup> For automatic 2-sided printing models.

## [Printer]

Level 3	Level 4	Description
Resolution	-	Select a print resolution.
Density	-	Increase or decrease the print density.
Print Settings <sup>1</sup>	-	Set your print settings to <i>Text</i> or <i>Graphics</i> .
Print Options <sup>1</sup>	Font List	Print the font list and samples of HP LaserJet.
	Test Print	Print the test page.
Test Print <sup>2</sup>	-	Print the test page.
2-sided (For automatic 2-sided printing models)	2-sided Print	Select whether to print on both sides of the paper.
	Single Image	For a print job where the last page is a one-sided image, select the <i>1-sided Feed</i> option to reduce printing time.  When you use letterhead or preprinted paper, you must select the <i>2-sided Feed</i> option. If you select <i>1-sided Feed</i> for letterhead or preprinted paper, the last page will be printed on the reverse side.
Auto Continue	-	Select if you want the machine to clear paper size errors or media type errors automatically, and use paper from other trays.
Paper Type <sup>1</sup>	-	Set the paper type.
Paper Size <sup>1</sup>	-	Set the paper size.
Copies <sup>1</sup>	-	Set the number of printed pages.
Orientation <sup>1</sup>	-	Set pages to print in either portrait or landscape orientation.
Print Position	X Offset	Adjust the print start position (usually at the upper left corner of a page) for the paper you loaded in the paper tray horizontally from -500 (left) to +500 (right) dots when printing at 300 dpi.
	Y Offset	Adjust the print start position (usually at the upper left corner of a page) for the paper you loaded in the paper tray vertically from -500 (up) to +500 (down) dots when printing at 300 dpi.
Auto FF <sup>1</sup>	-	Allow the machine to print any remaining data automatically.
HP LaserJet <sup>1</sup>	Font No.	Set the font number.  This menu appears if a soft font is installed on your Brother machine.
	Font Pitch	Set the font pitch. (Available only for certain fonts.)
	Font Point	Set the font size.

Level 3	Level 4	Description
HP LaserJet <sup>1</sup>		(Available only for certain fonts.)
	Symbol Set	Select the symbol or character set.
	Table Print	Print the code table.
	Auto LF	ON: CR -> CR+LF, OFF: CR -> CR
	Auto CR	ON: LF -> LF+CR, FF -> FF+CR, or VT -> VT+CR OFF: LF -> LF, FF -> FF, or VT -> VT
	Auto WRAP	Select whether you want a line feed and carriage return when the carriage position reaches the right margin.
	Auto SKIP	Select whether you want a line feed and carriage return when the carriage position reaches the bottom margin.
	Left Margin	Set the left margin at column 0 to 70 columns at 1 cpi.
	Right Margin	Set the right margin at column 10 to 80 columns at 1 cpi.
	Top Margin	Set the top margin distance from the top edge of the paper.
	Bottom Margin	Set the bottom margin distance from the bottom edge of the paper.
	Lines	Set the number of lines on each page.
Tray Command	Select this setting if a tray mismatch appears when you use the HP drivers.	
Reset Printer	-	Restore the machine settings to the factory settings.

<sup>1</sup> For models with PCL6 emulation.

<sup>2</sup> For models without PCL6 emulation.

### [Network] (HL-L2405W/HL-L2420DW)

Level 3	Level 4	Level 5	Level 6	Descriptions		
WLAN (Wi-Fi)	Find Network	-	-	Configure your wireless network settings manually.		
	TCP/IP	Boot Method	-	-	Choose the IP method that best suits your needs.	
		IP Address	-	-	Enter the IP address.	
		Subnet Mask	-	-	Enter the Subnet mask.	
		Gateway	-	-	Enter the Gateway address.	
		Node Name	-	-	Enter the Node name.	
		WINS Config	-	-	Select the WINS configuration mode.	
		WINS Server	Primary	-	-	Specify the IP address of the primary WINS server.
			Secondary	-	-	Specify the IP address of the secondary WINS server.
		DNS Server	Primary	-	-	Specify the IP address of the primary DNS server.
			Secondary	-	-	Specify the IP address of the secondary DNS server.
	APIPA	-	-	Allocate the IP address from the link-local address range automatically. <sup>1</sup>		



Level 3	Level 4	Level 5	Level 6	Descriptions	
WLAN (Wi-Fi)	TCP/IP	IPv6	-	Enable or disable the IPv6 protocol.	
	WPS/Push Button	-	-	Configure your wireless network settings using the one-button push method.	
	WPS/PIN Code	-	-	Configure the wireless network settings using WPS with a PIN code.	
	Recover WLAN	-	-	Reboot the wireless module of the machine.	
	WLAN Status	Status	-	-	Display the wireless network connection status.
		Signal	-	-	Display the wireless network signal strength.
		Channel	-	-	Display the channel in use when Status is Active.
		Speed	-	-	Display the connection speed when Status is Active.
		SSID	-	-	Display the wireless SSID (Network Name).
	Comm. Mode	-	-	Display the current Communication mode.	
MAC Address	-	-	Display your machine's MAC address.		
WLAN Enable	-	-	Turn the wireless interface on or off.		
Wi-Fi Direct	Manual	-	-	Configure your Wi-Fi Direct network settings manually.	
	Group Owner	-	-	Set your machine as the Group Owner.	
	Push Button	-	-	Configure your Wi-Fi Direct network settings using the one-push method before the operation times out.	
	PIN Code	-	-	Configure your Wi-Fi Direct network settings using WPS with a PIN code before the operation times out.	
	Device Info.	Device Name	-	-	View your machine's device name.
		SSID	-	-	Display the Group Owner's SSID (Network Name).
		IP Address	-	-	Display your machine's IP Address.
	Status Info.	Status	-	-	Display the Wi-Fi Direct network status.
		Signal	-	-	Display the current Wi-Fi Direct network signal strength. When your machine acts as Group Owner, the LCD always displays Strong.
		Channel	-	-	Display the channel in use when the Status is G/O Active or Client Active.
		Speed	-	-	Display the connection speed when the Status is G/O Active or Client Active.
I/F Enable	-	-	Enable or disable the Wi-Fi Direct connection.		
Web Based Mgmt	-	-	-	Enable or disable Web Based Management. If you enable this function, make sure you specify the connection method to use Web Based Management.	
Global Detect	Allow Detect	-	-	Enable or disable Global Detect, a function that detects and notifies the user when the user unintentionally connects to a global network.	
	Reject Access	-	-	Disable connections to the global network.	

Level 3	Level 4	Level 5	Level 6	Descriptions
<b>Network Reset</b>	-	-	-	Restore the machine's network settings back to the factory settings, except the administrator password.

- <sup>1</sup> On connection to the network, if the machine's 'Boot Method' is 'Auto' the machine will attempt to set the IP address and Subnet Mask from a boot server such as DHCP. If a boot server cannot be found, an APIPA IP address will be allocated, such as 169. 254. (001-254). (000-255). If the 'Boot Method' of the machine is set to 'Static' you must manually enter an IP address from the machine's control panel.

### [Network] (HL-L2460DW/HL-L2460DWXL/HL-L2865DW)

Level 3	Level 4	Level 5	Level 6	Descriptions
<b>Wired LAN</b>	<b>TCP/IP</b>	<b>Boot Method</b>	-	Choose the IP method that best suits your needs.
		<b>IP Address</b>	-	Enter the IP address.
		<b>Subnet Mask</b>	-	Enter the Subnet mask.
		<b>Gateway</b>	-	Enter the Gateway address.
		<b>Node Name</b>	-	Enter the Node name.
		<b>WINS Config</b>	-	Select the WINS configuration mode.
		<b>WINS Server</b>	<b>Primary</b>	Specify the IP address of the primary WINS server.
			<b>Secondary</b>	Specify the IP address of the secondary WINS server.
		<b>DNS Server</b>	<b>Primary</b>	Specify the IP address of the primary DNS server.
			<b>Secondary</b>	Specify the IP address of the secondary DNS server.
	<b>APIPA</b>	-	Allocate the IP address from the link-local address range automatically. <sup>1</sup>	
	<b>IPv6</b>	-	Enable or disable the IPv6 protocol.	
	<b>Ethernet</b>	-	-	Choose the Ethernet link mode.
	<b>Wired Status</b>	-	-	Display the wired network connection status.
<b>MAC Address</b>	-	-	Display your machine's MAC address.	
<b>Set to Default</b>	-	-	Restore your machine's wired network settings to the factory settings.	
<b>Wired Enable</b>	-	-	Turn on or off the wired interface.	
<b>WLAN (Wi-Fi)</b>	<b>Find Network</b>	-	-	Configure your wireless network settings manually.
	<b>TCP/IP</b>	<b>Boot Method</b>	-	Choose the IP method that best suits your needs.
		<b>IP Address</b>	-	Enter the IP address.
		<b>Subnet Mask</b>	-	Enter the Subnet mask.
		<b>Gateway</b>	-	Enter the Gateway address.
		<b>Node Name</b>	-	Enter the Node name.
		<b>WINS Config</b>	-	Select the WINS configuration mode.
		<b>WINS Server</b>	<b>Primary</b>	Specify the IP address of the primary WINS server.

Level 3	Level 4	Level 5	Level 6	Descriptions	
WLAN (Wi-Fi)	TCP/IP	WINS Server	Secondary	Specify the IP address of the secondary WINS server.	
		DNS Server	Primary	Specify the IP address of the primary DNS server.	
			Secondary	Specify the IP address of the secondary DNS server.	
		APIPA	-	Allocate the IP address from the link-local address range automatically. <sup>1</sup>	
		IPv6	-	Enable or disable the IPv6 protocol.	
	WPS/Push Button	-	-	Configure your wireless network settings using the one-button push method.	
	WPS/PIN Code	-	-	Configure the wireless network settings using WPS with a PIN code.	
	Recover WLAN	-	-	Reboot the wireless module of the machine.	
	WLAN Status	Status	-	Display the wireless network connection status.	
		Signal	-	Display the wireless network signal strength.	
		Channel	-	Display the channel in use when Status is Active.	
		Speed	-	Display the connection speed when Status is Active.	
		SSID	-	Display the wireless SSID (Network Name).	
		Comm. Mode	-	Display the current Communication mode.	
	MAC Address	-	-	Display your machine's MAC address.	
	Set to Default	-	-	Restore your machine's wireless network settings to the factory settings.	
	WLAN Enable	-	-	Turn the wireless interface on or off.	
	Wi-Fi Direct	Manual	-	-	Configure your Wi-Fi Direct network settings manually.
		Group Owner	-	-	Set your machine as the Group Owner.
		Push Button	-	-	Configure your Wi-Fi Direct network settings using the one-push method before the operation times out.
PIN Code		-	-	Configure your Wi-Fi Direct network settings using WPS with a PIN code before the operation times out.	
Device Info.		Device Name	-	View your machine's device name.	
		SSID	-	Display the Group Owner's SSID (Network Name).	
		IP Address	-	Display your machine's IP Address.	
Status Info.		Status	-	Display the Wi-Fi Direct network status.	
		Signal	-	Display the current Wi-Fi Direct network signal strength. When your machine acts as Group Owner, the LCD always displays Strong.	
		Channel	-	Display the channel in use when the Status is G/O Active or Client Active.	

Level 3	Level 4	Level 5	Level 6	Descriptions
Wi-Fi Direct	Status Info.	Speed	-	Display the connection speed when the Status is G/O Active or Client Active.
	I/F Enable	-	-	Enable or disable the Wi-Fi Direct connection.
Web Based Mgmt	-	-	-	Enable or disable Web Based Management. If you enable this function, make sure you specify the connection method to use Web Based Management.
Global Detect	Allow Detect	-	-	Enable or disable Global Detect, a function that detects and notifies the user when the user unintentionally connects to a global network.
	Reject Access	-	-	Disable connections to the global network.
Network Reset	-	-	-	Restore the machine's network settings back to the factory settings, except the administrator password.

- <sup>1</sup> On connection to the network, if the machine's 'Boot Method' is 'Auto' the machine will attempt to set the IP address and Subnet Mask from a boot server such as DHCP. If a boot server cannot be found, an APIPA IP address will be allocated, such as 169. 254. (001-254). (000-255). If the 'Boot Method' of the machine is set to 'Static' you must manually enter an IP address from the machine's control panel.

### [Print Reports]

Level 3	Description
Printer Settings	Print the Printer Settings page.
Network Config (For network models)	Print the Network Configuration Report.
Print File List	Print a list of data saved in the memory.
Drum Dot Print	Print the Drum Dot Check Sheet.
WLAN Report (For wireless models)	Print the wireless connection diagnostics report.

### [Machine Info.]

Level 3	Level 4	Description
Serial No.	-	Display the machine's serial number.
Firmware Version	Main Version	Check your machine's firmware version.
	Security Version	
Page Counter	-	Display the total number of printed pages.
Parts Life <sup>1</sup>	Toner	Display the remaining life of the toner cartridge.
	Drum	Display the remaining life of the drum unit.

- <sup>1</sup> The parts life is approximate and may vary by type of use.

### [Initial Setup]

Level 3	Level 4	Description
Reset	Machine Reset	Restore all the machine's settings that you have changed, such as Paper Type.
	Network Reset	Restore the machine's network settings back to the factory settings, except the administrator password.

---

Level 3	Level 4	Description
Reset	Factory Reset	Reset the machine and restore the printer settings (including command settings) to the factory settings.
Local Language	-	Select the LCD language for your country.



### Related Information

- [Menu Table \(for LCD Models\)](#)

#### Related Topics:

- [Configure Network Details Using the Control Panel](#)
-

## Print a List of Printer Settings

>> [HL-L2400D](#)

>> [HL-L2405W/HL-L2420DW/HL-L2460DW/HL-L2460DWXL/HL-L2865DW](#)

### HL-L2400D

1. Make sure that the front cover is closed and the power cord is plugged in.
2. Press  to turn on the machine and make sure only the **Ready** LED lights up.
3. Press **Go** three (3) times.

The machine prints the Printer Settings.

### HL-L2405W/HL-L2420DW/HL-L2460DW/HL-L2460DWXL/HL-L2865DW

1. Press **▲** or **▼** to display the [Print Reports] option, and then press **OK**.
2. Press **▲** or **▼** to display the [Printer Settings] option, and then press **OK**.
3. Press **Go**.

The machine prints the Printer Settings.



### Related Information



- [Machine Settings](#)

## Change Machine Settings from Windows Printer Driver

Related Models: HL-L2400D

For LED models, the following machine setting items are available on the Windows printer driver.

- **Paper Size**
- **Auto Power Off**
- **Auto Continue**

1. Hold down the  key and press the  key on the computer's keyboard to launch **Run**.
2. Type "**control printers**" in the **Open:** field and click **OK**.

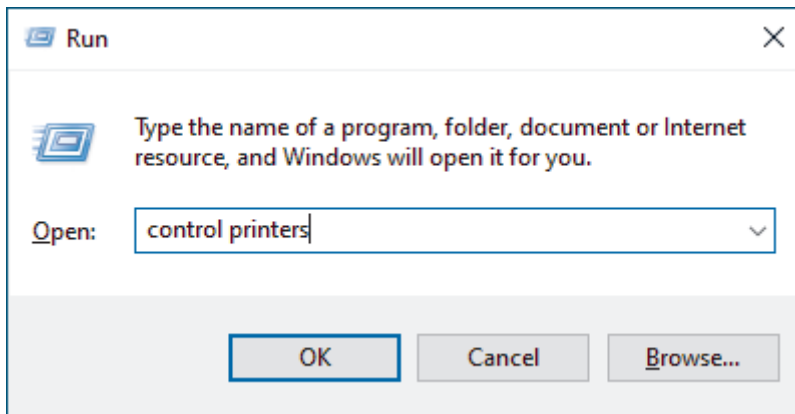

3. Right-click your model, and then select **Printer properties**. (If the printer driver options appear, select your printer driver.)  
The printer properties dialog box appears.
4. Click the **Device Settings** tab.
5. Select a paper source in the **Paper Size** list.
6. Click the **Paper Size** drop-down list, and then select a paper size for the selected paper source.
7. Click the **Update** button.
8. Click the **Auto Power Off** drop-down list, and then select time to transition from Deep Sleep Mode to power off.
9. Click the **Auto Continue** drop-down list, and then select **On** if you want the machine to clear paper size errors or media type errors automatically.
10. Click the **Apply** button.
11. Close the printer properties dialog box.

### Related Information

- [Machine Settings](#)

## Change Machine Settings Using Web Based Management

**Related Models:** HL-L2405W/HL-L2420DW/HL-L2460DW/HL-L2460DWXL/HL-L2865DW

Web Based Management is a utility that uses a standard web browser to manage your machine using the Hyper Text Transfer Protocol (HTTP) or Hyper Text Transfer Protocol over Secure Socket Layer (HTTPS).

- [What is Web Based Management?](#)
- [Access Web Based Management](#)
- [Change the Login Password Using Web Based Management](#)



## What is Web Based Management?

**Related Models:** HL-L2405W/HL-L2420DW/HL-L2460DW/HL-L2460DWXL/HL-L2865DW

Web Based Management is a utility that uses a standard web browser to manage your machine using the Hyper Text Transfer Protocol (HTTP) or Hyper Text Transfer Protocol over Secure Socket Layer (HTTPS).



- We recommend using the latest version of the following web browsers:
  - Microsoft Edge, Firefox, and Google Chrome™ for Windows
  - Safari, Firefox, and Google Chrome™ for Mac
  - Google Chrome™ for Android™
  - Safari and Google Chrome™ for iOS
- Ensure that JavaScript and Cookies are always enabled, regardless of which browser you use.
- HL-L2405W/HL-L2420DW/HL-L2460DW/HL-L2460DWXL/HL-L2865DW:  
Make sure your machine is On and connected to the same network as your computer, and that your network supports the TCP/IP protocol.

The screenshot shows the Brother web-based management interface for the XXX-XXXX series. The interface is divided into a left navigation menu and a main content area. The navigation menu includes a 'Home' button, a 'Status' button (which is currently selected), and an 'Auto Refresh Interval' button. The main content area displays the 'Status' section, which includes a 'Device Status' indicator showing 'Sleep', an 'Automatic Refresh' section with radio buttons for 'Off' (selected) and 'On', and a 'Toner Level' section showing a vertical bar and the label 'BK'. The Brother logo is visible in the top right corner of the interface.

The actual screen may differ from the screen shown above.



### Related Information

- [Change Machine Settings Using Web Based Management](#)

## Access Web Based Management

**Related Models:** HL-L2405W/HL-L2420DW/HL-L2460DW/HL-L2460DWXL/HL-L2865DW

- We recommend using the latest version of the following web browsers:
  - Microsoft Edge, Firefox, and Google Chrome™ for Windows
  - Safari, Firefox, and Google Chrome™ for Mac
  - Google Chrome™ for Android™
  - Safari and Google Chrome™ for iOS
- Ensure that JavaScript and Cookies are always enabled, regardless of which browser you use.
- We recommend using the HTTPS security protocol when configuring settings using Web Based Management. If you use HTTP when configuring settings using Web Based Management, follow the screen prompts to switch to a secure HTTPS connection.
- When you use HTTPS for Web Based Management configuration, your browser will display a warning dialog box. To avoid displaying the warning dialog box, you can install a self-signed certificate to use SSL/TLS communication. For more information, see *Related Information*.
- The default password to manage this machine's settings is located on the back of the machine and marked "**Pwd**". Change the default password by following the on-screen instructions when you first log in. We recommend immediately changing the default password to protect your machine from unauthorized access.

You can also find the default password in the Network Configuration Report.

>> [Access Web Based Management from your Web Browser](#)

>> [Access Web Based Management from Brother iPrint&Scan \(Windows/Mac\)](#)

>> [Access Web Based Management from Brother Utilities \(Windows\)](#)

### Access Web Based Management from your Web Browser

1. Start your web browser.
2. Type "https://machine's IP address" in your browser's address bar (where "machine's IP address" is your machine's IP address).

For example:

https://192.168.1.2



- If you are using a Domain Name System or enable a NetBIOS name, you can type another name, such as "SharedPrinter" instead of the IP address.

For example: https://SharedPrinter

- If you enable a NetBIOS name, you can also use the node name.

For example: https://brn123456abcdef

- The NetBIOS name can be found in the Network Configuration Report.

3. If required, type the password in the **Login** field, and then click **Login**.



The default password to manage this machine's settings is located on the back of the machine and marked "**Pwd**". Change the default password by following the on-screen instructions when you first log in.

4. If you want to pin the navigation bar to the left side of the screen, click ☰ and then click 🌟.

You can now change the machine's settings.



If the machine is idle for a specified amount of time, the user is automatically logged out. Change the logout settings in the **Logout Time** menu.

## Access Web Based Management from Brother iPrint&Scan (Windows/Mac)

1. Start Brother iPrint&Scan.

- Windows

Launch  (**Brother iPrint&Scan**).

- Mac

In the **Finder** menu bar, click **Go > Applications**, and then double-click the iPrint&Scan icon.

The Brother iPrint&Scan screen appears.

2. If your Brother machine is not selected, click the **Select your Machine** button, and then select your model name from the list. Click **OK**.

3. Click  (**Supplies/Machine Settings**).

4. Click **All Settings**.

The Web Based Management page appears.

5. If required, type the password in the **Login** field, and then click **Login**.



The default password to manage this machine's settings is located on the back of the machine and marked "**Pwd**". Change the default password by following the on-screen instructions when you first log in.

6. If you want to pin the navigation bar to the left side of the screen, click  and then click .

You can now change the machine's settings.



You can also access Web Based Management from Brother Mobile Connect for mobile devices.

## Access Web Based Management from Brother Utilities (Windows)

1. Launch  (**Brother Utilities**), and then click the drop-down list and select your model name (if not already selected).

2. Click **Tools** in the left navigation bar, and then click **Machine Settings**.

The Web Based Management page appears.

3. If required, type the password in the **Login** field, and then click **Login**.



The default password to manage this machine's settings is located on the back of the machine and marked "**Pwd**". Change the default password by following the on-screen instructions when you first log in.

4. If you want to pin the navigation bar to the left side of the screen, click  and then click .

You can now change the machine's settings.

If you change the protocol settings, you must restart the machine after clicking **Submit** to activate the configuration.

After configuring the settings, click **Logout**.

## Related Information

- [Change Machine Settings Using Web Based Management](#)

### Related Topics:

- [Print the Network Configuration Report](#)
- [Create a Self-signed Certificate](#)

- 
- Install the Self-signed Certificate for Windows Users as Administrators
  - Use SSL/TLS
-

## Change the Login Password Using Web Based Management

The default password to manage this machine's settings is located on the back of the machine and marked "Pwd". Change the default password by following the on-screen instructions when you first log in. We recommend immediately changing the default password to protect your machine from unauthorized access.

1. Start your web browser.
2. Type "https://machine's IP address" in your browser's address bar (where "machine's IP address" is your machine's IP address).

For example:

https://192.168.1.2



- If you are using a Domain Name System or enable a NetBIOS name, you can type another name, such as "SharedPrinter" instead of the IP address.

For example: https://SharedPrinter

- If you enable a NetBIOS name, you can also use the node name.

For example: https://brn123456abcdef

- The NetBIOS name can be found in the Network Configuration Report.

3. Do one of the following:
  - If you have previously set your own password, type it, and then click **Login**.
  - If you have not previously set your own password, type the default login password, and then click **Login**.
4. In the left navigation bar, click **Administrator > Login Password**.



- The default password to manage this machine's settings is located on the back of the machine and marked "Pwd".

- If the left navigation bar is not visible, start navigating from ☰.

5. To change the password, type your current password in the **Enter Old Password** field.
6. Following the on-screen **Login Password** guidelines, type your new password in the **Enter New Password** field.
7. Retype the new password in the **Confirm New Password** field.
8. Click **Submit**.



You can also change the lockout settings in the **Login Password** menu.



### Related Information

- [Change Machine Settings Using Web Based Management](#)

## Appendix

- [Specifications](#)
- [Supplies](#)
- [Brother Help and Customer Support](#)

## Specifications

- >> General Specifications
- >> Print Media Specifications
- >> Printer Specifications
- >> Interface Specifications
- >> Supported Protocols and Security Features
- >> Computer Requirements Specifications

### General Specifications

<b>Printer Type</b>		Laser
<b>Print Method</b>		Electrophotographic Laser Printer
<b>Memory Capacity</b>	<b>Standard</b>	<ul style="list-style-type: none"> <li>• (HL-L2400D/HL-L2405W/HL-L2420DW) 64 MB</li> <li>• (HL-L2460DW/HL-L2460DWXL/HL-L2865DW) 128 MB</li> </ul>
<b>Machine display</b>		(HL-L2405W/HL-L2420DW/HL-L2460DW/ HL-L2460DWXL/HL-L2865DW) 16 characters x 1 line
<b>Power Source</b>		110 V to 120 V AC 50/60 Hz
<b>Power Consumption</b> (Average)	<b>Peak</b>	Approximately 920 W
	<b>Printing</b> <sup>1</sup>	<ul style="list-style-type: none"> <li>• (HL-L2400D/HL-L2405W/HL-L2420DW) Approximately 450 W at 77°F (25°C)</li> <li>• (HL-L2460DW/HL-L2460DWXL/HL-L2865DW) Approximately 470 W at 77°F (25°C)</li> </ul>
	<b>Printing (Quiet Mode)</b> <sup>1</sup>	Approximately 260 W at 77°F (25°C)
	<b>Ready</b> <sup>1</sup>	Approximately 44 W at 77°F (25°C)
	<b>Sleep</b> <sup>1</sup>	<ul style="list-style-type: none"> <li>• (HL-L2400D) Approximately 3.7 W</li> <li>• (HL-L2405W/HL-L2420DW) Approximately 4.0 W</li> <li>• (HL-L2460DW/HL-L2460DWXL/HL-L2865DW) Approximately 3.8 W</li> </ul>
	<b>Deep Sleep</b> <sup>1</sup>	<ul style="list-style-type: none"> <li>• (HL-L2400D/HL-L2460DW/HL-L2460DWXL/ HL-L2865DW) Approximately 0.4 W</li> <li>• (HL-L2405W/HL-L2420DW) Approximately 0.6 W</li> </ul>
	<b>Power Off</b> <sup>2 3</sup>	Approximately 0.06 W
<b>Dimensions</b> (Typical outline view)		Unit: in. (mm) * : 14.0 (356) ** : 7.2 (183) *** : 14.2 (360)

<sup>1</sup> Measured when the machine is connected using the same network connection as the ENERGY STAR Ver. 3.1 test method.

<sup>2</sup> Measured according to IEC 62301 Edition 2.0.

<sup>3</sup> Power consumption varies slightly depending on the usage environment.

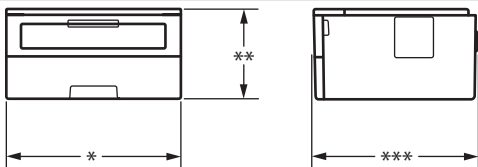
			
<b>Weight (with supplies)</b>		<ul style="list-style-type: none"> <li>(HL-L2405W) 15.1 lb (6.9 kg)</li> <li>(HL-L2400D/HL-L2420DW/HL-L2460DW) 15.6 lb (7.1 kg)</li> <li>(HL-L2865DW) 15.8 lb (7.2 kg)</li> <li>(HL-L2460DWXL) 17.7 lb (8.1 kg)</li> </ul>	
<b>Noise Level</b>	<b>Sound Pressure</b> <sup>4</sup>	<b>Printing</b>	<ul style="list-style-type: none"> <li>(HL-L2400D/HL-L2405W/HL-L2420DW) LpAm = 48 dB (A)</li> <li>(HL-L2460DW/HL-L2460DWXL/HL-L2865DW) LpAm = 49 dB (A)</li> </ul>
		<b>Printing (Quiet Mode)</b>	LpAm = 44 dB (A)
		<b>Ready</b>	LpAm = Up to 30 dB (A)
	<b>Sound Power</b>	<b>Printing</b> <sup>4</sup>	<ul style="list-style-type: none"> <li>(HL-L2400D/HL-L2405W/HL-L2420DW) LWAc = 6.56 B (A)</li> <li>(HL-L2460DW/HL-L2460DWXL/HL-L2865DW) LWAc = 6.65 B (A)</li> </ul>
		<b>Printing (Quiet Mode)</b>	LWAc = 6.06 B (A)
		<b>Ready</b>	LWAc = Inaudible
<b>Temperature</b>	<b>Operating</b>	From 50°F to 90.5°F (10°C to 32.5°C)	
	<b>Storage</b>	From 32°F to 104°F (0°C to 40°C)	
<b>Humidity</b>	<b>Operating</b>	20% to 80% (without condensation)	
	<b>Storage</b>	35% to 85% (without condensation)	

## Print Media Specifications

<b>Paper Input</b>	<b>Paper Tray (Standard)</b>	<b>Paper Type</b>	Plain Paper, Thin Paper, Recycled Paper, Thick Paper
		<b>Paper Size</b>	A4, Letter, B5 (JIS), B5 (ISO), A5, A5 (Long Edge), B6 (JIS), A6, Executive, Legal, Mexico Legal, India Legal, Folio, 16K (195x270 mm), A4 Short (270mm Paper)
		<b>Paper Weight</b>	16 to 43 lb (60 to 163 g/m <sup>2</sup> ) <sup>1</sup>
		<b>Maximum Paper Capacity</b>	Up to 250 sheets of 20 lb (80 g/m <sup>2</sup> ) Plain Paper
	<b>Manual Feed Slot</b>	<b>Paper Type</b>	Plain Paper, Thin Paper, Thick Paper, Thicker Paper, Recycled Paper, Bond, Label, Envelope, Env.Thin, Env.Thick
		<b>Paper Size</b>	<ul style="list-style-type: none"> <li>Width: 3 to 8.5 in. (76.2 to 215.9 mm)</li> <li>Length:</li> </ul>

<sup>4</sup> Measured in accordance with the method described in ISO 7779.



<b>Paper Input</b>	<b>Manual Feed Slot</b>		5 to 14 in. (127 to 355.6 mm) • Envelope: COM-10, DL, C5, Monarch
		<b>Paper Weight</b>	16 to 61 lb (60 to 230 g/m <sup>2</sup> )
		<b>Maximum Paper Capacity</b>	One sheet at a time
<b>Paper Output</b> <sup>2</sup>	<b>Face Down Output Tray</b>		Up to 100 Sheets of 20 lb (80 g/m <sup>2</sup> ) Plain Paper (face down delivery to the face down output paper tray)
	<b>Face Up Output Tray</b>		One sheet (face up delivery to the face up output tray)
<b>2-sided</b>	<b>Automatic 2-sided Printing</b>	<b>Paper Type</b>	Plain Paper, Thin Paper, Recycled Paper
		<b>Paper Size</b>	Letter, Legal, Folio, Mexico Legal, India Legal
		<b>Paper Weight</b>	16 to 28 lb (60 to 105 g/m <sup>2</sup> )

<sup>1</sup> For paper of 28 lb (105 g/m<sup>2</sup>) and above, open the back cover to use the face up output tray.

<sup>2</sup> For labels, we recommend removing the printed sheets from the output paper tray immediately after they exit the machine to avoid the possibility of smudging.

## Printer Specifications

<b>Automatic 2-sided Print</b>		(HL-L2400D/HL-L2420DW/HL-L2460DW/HL-L2460DWXL/HL-L2865DW) Yes
<b>Emulation</b>		(HL-L2460DW/HL-L2460DWXL/HL-L2865DW) PCL6
<b>Resolution</b>		Up to 1200 x 1200 dpi
<b>Print Speed</b> <sup>1 2</sup>	<b>1-sided Print</b> <sup>3</sup>	<ul style="list-style-type: none"> <li>• (HL-L2405W/HL-L2420DW) Up to 28 pages/minute (A4 size) Up to 30 pages/minute (Letter size)</li> <li>• (HL-L2400D) Up to 30 pages/minute (A4 size) Up to 32 pages/minute (Letter size)</li> <li>• (HL-L2460DW/HL-L2460DWXL/HL-L2865DW) Up to 34 pages/minute (A4 size) Up to 36 pages/minute (Letter size)</li> </ul>
	<b>2-sided Print</b>	<ul style="list-style-type: none"> <li>• (HL-L2400D/HL-L2420DW) Up to 15 sides/minute (Up to 7.5 sheets/minute) (Letter or A4 size)</li> <li>• (HL-L2460DW/HL-L2460DWXL/HL-L2865DW) Up to 16 sides/minute (Up to 8 sheets/minute) (A4 size) Up to 17 sides/minute (Up to 8.5 sheets/minute) (Letter size)</li> </ul>
<b>First Print Time</b> <sup>4</sup>		Less than 8.5 seconds at 73.4°F (23°C)

<sup>1</sup> The print speed may change depending on the type of document you print.

<sup>2</sup> The print speed may be slower when the machine is connected by wireless LAN.

<sup>3</sup> These print speeds are for 1-sided printing and measured in accordance with ISO/IEC 24734.

<sup>4</sup> From Ready mode and standard tray.

## Interface Specifications

<b>USB</b>	Type: USB Type-B receptacle Version: USB 2.0 High-Speed <sup>1 2</sup> Use a USB 2.0 interface cable that is no more than 6 feet (2 meters) long.
------------	---

<b>LAN</b>	(HL-L2460DW/HL-L2460DWXL/HL-L2865DW) 10Base-T/100Base-TX <sup>3</sup>
<b>Wireless LAN</b>	(HL-L2405W/HL-L2420DW/HL-L2460DW/HL-L2460DWXL/HL-L2865DW) IEEE 802.11a/b/g/n (Infrastructure Mode) IEEE 802.11a/g/n (Wi-Fi Direct®)

<sup>1</sup> Your machine has a USB 2.0 Hi-Speed interface. The machine can also be connected to a computer that has a USB 1.1 interface.

<sup>2</sup> Third party USB hub devices are not supported.

<sup>3</sup> Use a straight-through Category 5 (or greater) twisted-pair cable.

## Supported Protocols and Security Features

Supported protocols and security features may differ depending the models.

### Ethernet

10Base-T/100Base-TX

### Wireless LAN (2.4 GHz)

IEEE 802.11b/g/n (Infrastructure Mode), IEEE 802.11g/n (Wi-Fi Direct)

### Wireless LAN (5 GHz)

IEEE 802.11a/n (Infrastructure Mode), IEEE 802.11a/n (Wi-Fi Direct)

### Protocols (IPv4)

ARP, RARP, BOOTP, DHCP, APIPA(Auto IP), WINS/NetBIOS name resolution, DNS Resolver, mDNS, LLMNR responder, LPR/LPD, Custom Raw Port/Port9100, SMTP Client, IPP/IPPS, FTP Server, SNMPv1/v2c/v3, HTTP/HTTPS server, TFTP client and server, ICMP, Web Services (Print)

### Protocols (IPv6)

NDP, RA, DNS resolver, mDNS, LLMNR responder, LPR/LPD, Custom Raw Port/Port9100, IPP/IPPS, SMTP Client, FTP Server, SNMPv1/v2c/v3, HTTP/HTTPS server, TFTP client and server, ICMPv6, Web Services (Print)

### Network Security (Wired)

SMTP-AUTH, SNMP v3,SSL/TLS(SMTP,HTTP,IPP), 802.1x (EAP-MD5, EAP-FAST, PEAP, EAP-TLS, EAP-TTLS), OAuth(SMTP, POP3, IMAP4)

### Network Security (Wireless)

SMTP-AUTH, SNMP v3,SSL/TLS(SMTP,HTTP,IPP), 802.1x (EAP-FAST, PEAP, EAP-TLS, EAP-TTLS), OAuth(SMTP, POP3, IMAP4)

### Wireless Network Security

WEP 64/128 bit, WPA-PSK (TKIP/AES), WPA2-PSK (TKIP/AES) (Wi-Fi Direct supports WPA2-PSK (AES) only) , WPA3-SAE (AES)

### Wireless Certification

Wi-Fi Certification Mark License (WPA3™ - Enterprise, Personal), Wi-Fi Protected Setup™ (WPS) Identifier Mark License, Wi-Fi CERTIFIED™ Wi-Fi Direct

## Computer Requirements Specifications

Supported Operating Systems And Software Functions

Computer Platform & Operating System Version	Computer Interface			Processor	Hard Disk Space to Install <sup>1</sup>	
	USB <sup>2</sup>	Wired LAN	Wireless LAN		For Drivers	For Applications (including Drivers)

Windows 10 Home / 10 Pro / 10 Education / 10 Enterprise	Printing	32 bit (x86) or 64 bit (x64) processor	50 MB	1.6 GB
Windows 11 Home / 11 Pro / 11 Education / 11 Enterprise		64 bit (x64) processor		
Windows Server 2012	Printing	64 bit (x64) processor	50 MB	50 MB
Windows Server 2012 R2				
Windows Server 2016				
Windows Server 2019				
Windows Server 2022				
macOS v11 <sup>3</sup>	Printing	64 bit processor	N/A	500 MB
macOS v12 <sup>3</sup>				
macOS v13 <sup>3</sup>				
Chrome OS	Printing	N/A	N/A	N/A

<sup>1</sup> An Internet connection is required to install the software if the installation disc is not supplied.

<sup>2</sup> Third party USB ports are not supported.

<sup>3</sup> macOS Disclaimer

AirPrint capable: Printing via macOS requires the use of AirPrint. Mac drivers are not provided for this machine.

For the latest driver updates, go to your model's **Downloads** page at [support.brother.com](https://support.brother.com).

For the latest supported OS, go to your model's **Supported OS** page at [support.brother.com/os](https://support.brother.com/os).

All trademarks, brand and product names are the property of their respective companies.



## Related Information

- [Appendix](#)

## Supplies

When the time comes to replace supplies, such as the toner cartridge or drum unit, an error message will appear on your machine's control panel or in the Status Monitor. For more information about the supplies for your machine, visit [www.brother.com/original](http://www.brother.com/original) or contact your local Brother dealer.



The Supply Order Number (No.) varies depending on your country and region.

### Toner Cartridge

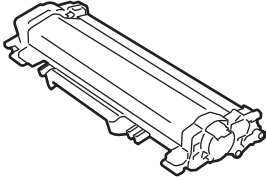

Supply Order No.	Approximate Life (Page Yield)	Applicable Models
Standard Toner: TN830	Approximately 1,200 pages <sup>1 2</sup>	HL-L2400D/HL-L2405W/ HL-L2420DW/HL-L2460DW/ HL-L2460DWXL/HL-L2865DW
High Yield Toner: TN830XL	Approximately 3,000 pages <sup>1 2</sup>	HL-L2400D/HL-L2405W/ HL-L2420DW/HL-L2460DW/ HL-L2460DWXL/HL-L2865DW
Super High Yield Toner: TN835	Approximately 5,000 pages <sup>1 2</sup>	HL-L2865DW
Value High Yield Toner: TN830V (available only in the USA)	Approximately 3,300 pages <sup>1 2</sup>	HL-L2400D/HL-L2405W/ HL-L2420DW/HL-L2460DW/ HL-L2460DWXL
Starter Toner: (Supplied with your machine)	Approximately 700 pages <sup>1 2</sup>	HL-L2400D/HL-L2405W/ HL-L2420DW/HL-L2460DW
	Approximately 1,200 pages <sup>1 2</sup>	HL-L2865DW
	Approximately 4,200 pages <sup>1 2</sup> (Standard Toner and High Yield Toner replacement are included in the carton.)	HL-L2460DWXL

<sup>1</sup> The approximate cartridge yield is declared in accordance with ISO/IEC 19752.

<sup>2</sup> A4/Letter single-sided pages

### Drum Unit

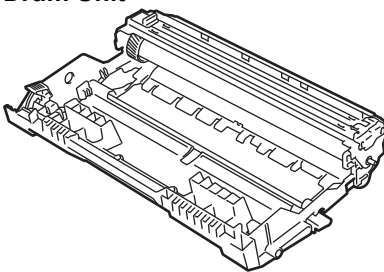

Supply Order No.	Approximate Life (Page Yield)	Applicable Models
Drum Unit: DR830	Approximately 15,000 pages <sup>1</sup>	HL-L2400D/HL-L2405W/ HL-L2420DW/HL-L2460DW/ HL-L2460DWXL/HL-L2865DW

<sup>1</sup> Approximately 15,000 pages based on one page per job (A4/Letter single-sided pages). The number of pages may be affected due to a variety of factors including but not limited to media type and media size.



## Related Information

- [Appendix](#)

## Brother Help and Customer Support

### IMPORTANT

For technical help, you must call the country where you bought the machine. Calls must be made **from within** that country.

>> [FAQs \(Frequently Asked Questions\)](#)

>> [For Customer Service](#)

>> [Ordering Accessories and Supplies](#)

### FAQs (Frequently Asked Questions)

For more information on your Brother machine, visit the Brother support website at [support.brother.com](http://support.brother.com). For additional help and tips, go to your model's **FAQs & Troubleshooting** page; for the latest drivers and software, go to your model's **Downloads** page.

### For Customer Service

#### In USA:

[www.brother-usa.com/support](http://www.brother-usa.com/support) (Self-Service/Email/Chat)

1-877-BROTHER (1-877-276-8437)

#### In Canada:

[www.brother.ca/support](http://www.brother.ca/support)

(Self-Service Videos, Email, Chat, Facebook and Twitter Help)

### Service Center Locator (USA only)

For the location of a Brother authorized service center, call 1-877-BROTHER (1-877-276-8437) or visit [www.brother-usa.com/support](http://www.brother-usa.com/support).

### Service Center Locations (Canada only)

For the location of a Brother authorized service center, visit [www.brother.ca/support](http://www.brother.ca/support).

### Ordering Accessories and Supplies

We recommend Genuine Brother supplies, which are available at most Brother retailers. If you cannot find the supplies you need and have a Visa, MasterCard, Discover, American Express credit card, or PayPal account, you can order directly from Brother. Visit us online for a complete selection of the Brother accessories and supplies that are available for purchase.

### NOTE

In Canada, only Visa and MasterCard are accepted.

#### In USA:

1-877-BROTHER (1-877-276-8437)

[www.brother-usa.com/support](http://www.brother-usa.com/support)

#### In Canada:

[www.brother.ca](http://www.brother.ca)



## Related Information

- [Appendix](#)

Brother International Corporation  
200 Crossing Boulevard  
P.O. Box 6911  
Bridgewater, NJ 08807-0911 USA

Brother International Corporation (Canada) Ltd.  
1 rue Hôtel de Ville,  
Dollard-des-Ormeaux, QC, Canada H9B 3H6

**brother**

These machines are approved for use in the country of purchase only. Local Brother companies or their dealers may only support machines purchased in their own countries.



USA/CAN  
Version A